

Key Features

- Compact size
- 2.4 - 2.5GHz operation



General Description

The Echo12 GSM/GPRS/3G ceramic chip antennas, introduced in 2009 provide a reliable, PCB solderable antenna for today's wireless modules operating on quad band GSM / GPRS frequencies or 3G networks.

Offering an omni directional radiating pattern, the chip antenna measures just 24mm x 5.5mm x 4.4mm to ensure suitability in small form factor applications.

Easy to layout and use in production, full documentation is available to provide design layout guidelines including a recommended matching circuit. The Siretta PCB antenna comes in a tape and reel package and is reflow solderable.

Key Specifications - Electrical

Operating temperature range:	-35 to +85°C
Impedance:	50 ohm
Gain:	0.67 to 5.25dB
VSWR:	3.0 : 1 max
Operating frequency:	850, 900, 1800, 1900MHz, 2.1GHz
Polarization:	Linear

Key Specifications - Mechanical

Dimensions:	24mm x 5.5mm x 4.4mm
Mounting method:	Embedded

Ordering Details:

Part Number	Description
ECHO12/x/x/S/S/3	GSM/GPRS/3G penta band PIFA embedded antenna

Rev 1.0

1. SPECIFICATIONS

1.1. Electrical Specifications

ITEM	GSM850	GSM 900	DCS	PCS	UMTS
Frequency [MHz]	824~894	880~960	1710~1880	1850~1990	1920~2170
Peak Gain [dBi]	0.67	1.56	5.25	5.00	5.52
Eff.[%] @Min	53%	60%	81%	76%	77%
VSWR	3.0 : 1 max				
Polarization	Linear				
Azimuth Beam Pattern	Omni-directional				
Impedance	50 Ω				

These values are measured on the matched reference test board.

1.2 . Mechanical Specifications

Electrode	Silver	-
Dimensions (L x W x H)	24.0 x 5.5 x 4.4	mm
Operating Temperature	-35 ~ +85	

1.3 . Appearance and Dimensions

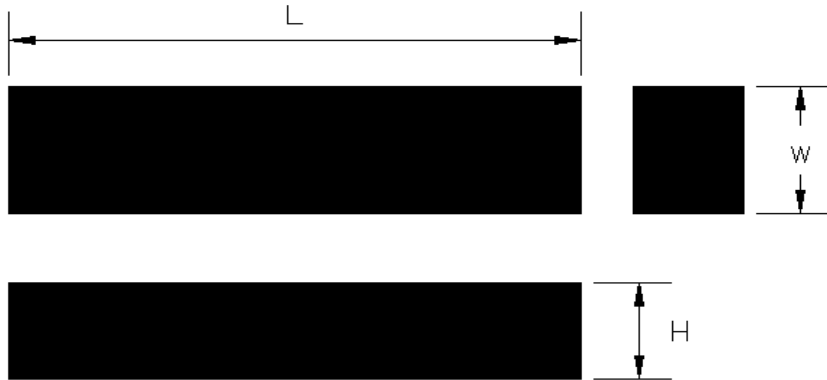

Unit : mm
Tolerance : ±0.15

L(Length)	24.0
W(Width)	5.5
H(Height)	4.4

2. MEASUREMENT

2.1 . SET for Measurement

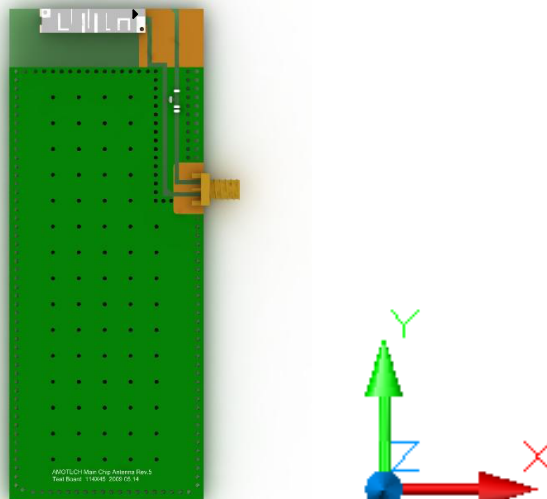

Board size: 114x45mm

Antenna Radiation the coordinate system

[X axis: the axis of rotation]

2. 2. Electrical Characteristic

- Antenna matching on the reference test board

☒ S_{11} (Return loss & VSWR)

Penta Band (GSM 850 &900 , DCS, PCS, UMTS)

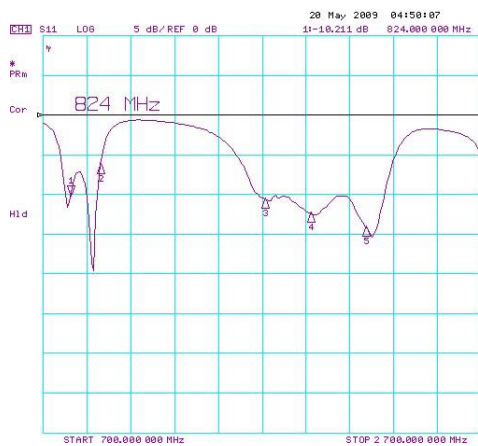

- Return loss -

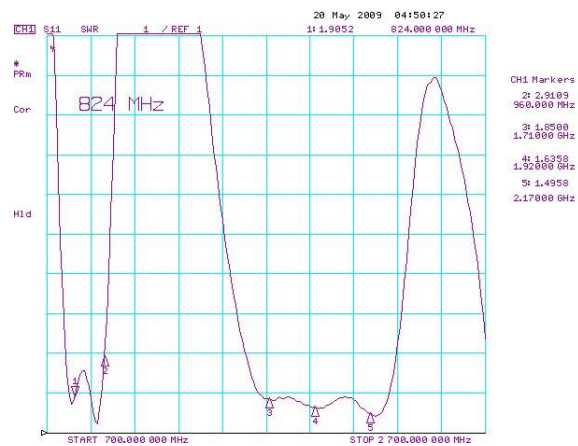

- SWR -

2. 3 . Radiation Characteristic

- Measurement Setup

- 6mx3mx3m Anechoic Chamber
- Matching on the standard test board (114 x 45mm)
- Temp. : 25 / Humidity : 50~55%

- Measurement Result

Band	Frequency MHz]	Ave. gain (dBi)	Peak. Gain (dBi)	Eff.(%)
GSM850	824	-2.73	-0.21	53.36
	849	-2.77	-0.51	54.37
	869	-2.74	-0.74	53.26
	894	-1.22	0.67	75.50
GSM900	880	-2.00	-0.11	63.06
	915	-0.50	1.42	89.16
	925	-0.49	1.56	89.37
	960	-2.22	0.58	60.03
DCS	1710	-0.12	4.98	97.24
	1785	-0.13	5.03	97.35
	1805	-0.28	5.25	93.84
	1880	-0.90	4.97	81.34
PCS	1850	-0.39	5.52	91.39
	1910	-1.03	4.97	78.90
	1930	-1.16	4.94	76.50
	1990	-0.80	4.98	83.12
UMTS	1920	-1.11	4.94	77.41
	1980	-0.94	5.00	80.51
	2110	-1.11	4.01	77.45
	2170	-0.12	4.71	97.24

3. SOLDERING RECOMMENDATIO NS

NS

3.1 . Soldering Land Pattern

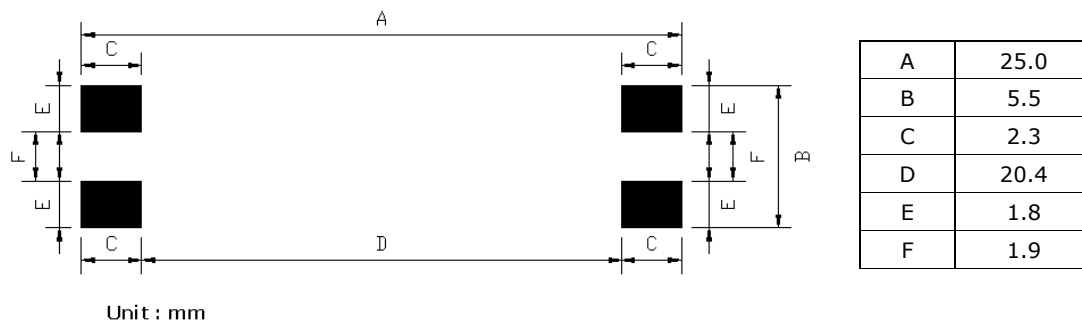

3.2. Free Space Size

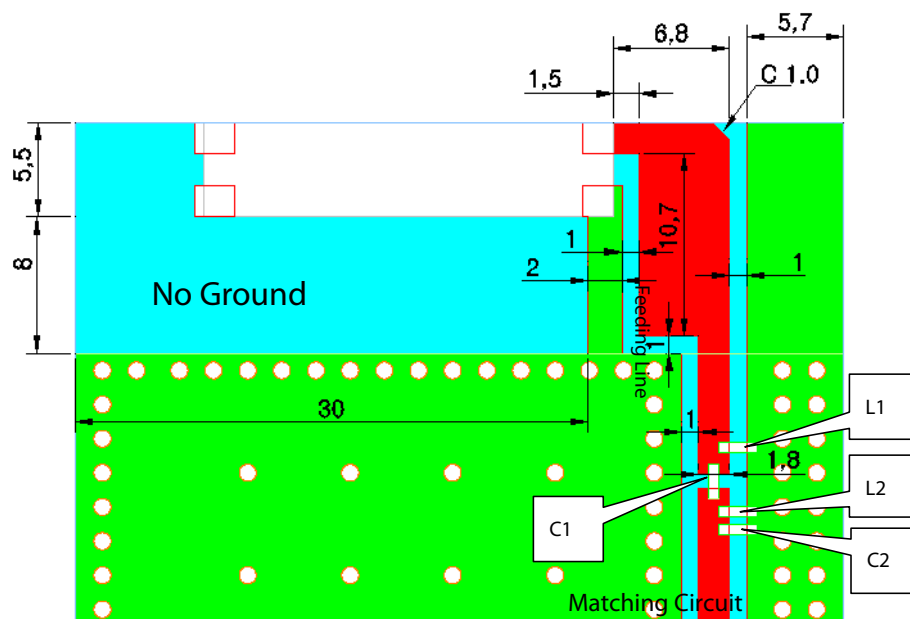

C1 (Series)	3.9pF
C2 (Shunt)	1.8pF
L1 (Shunt)	3.9nH
L2 (Shunt)	2.7nH

3.2. Soldering Profile

Solder paste : Sn/Ag/Cu:96.5/3.0/0.5

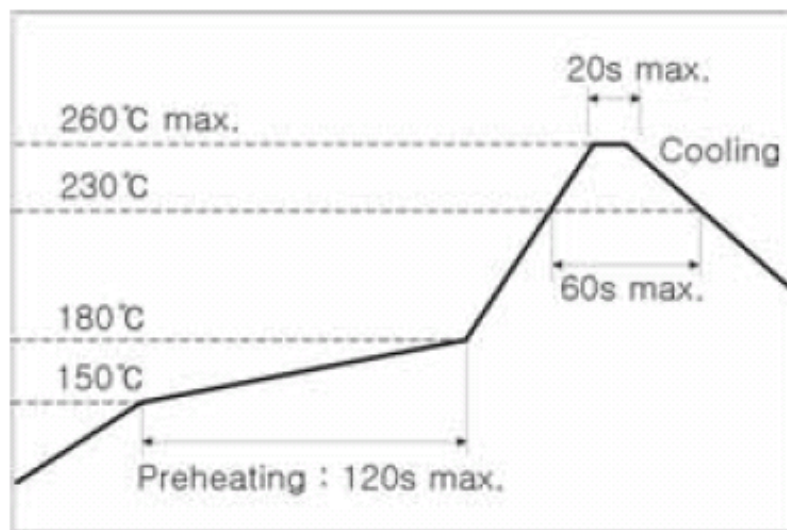

This product is designed for reflow soldering only. Do not use flow (wave) soldering.

- ① Use non-activated flux (Cl content 0.2% max.)
- ② Follow the recommended soldering conditions to avoid damage.
- ③ Reflow-cycle is max. 3 times.

4. A TTACHMENT

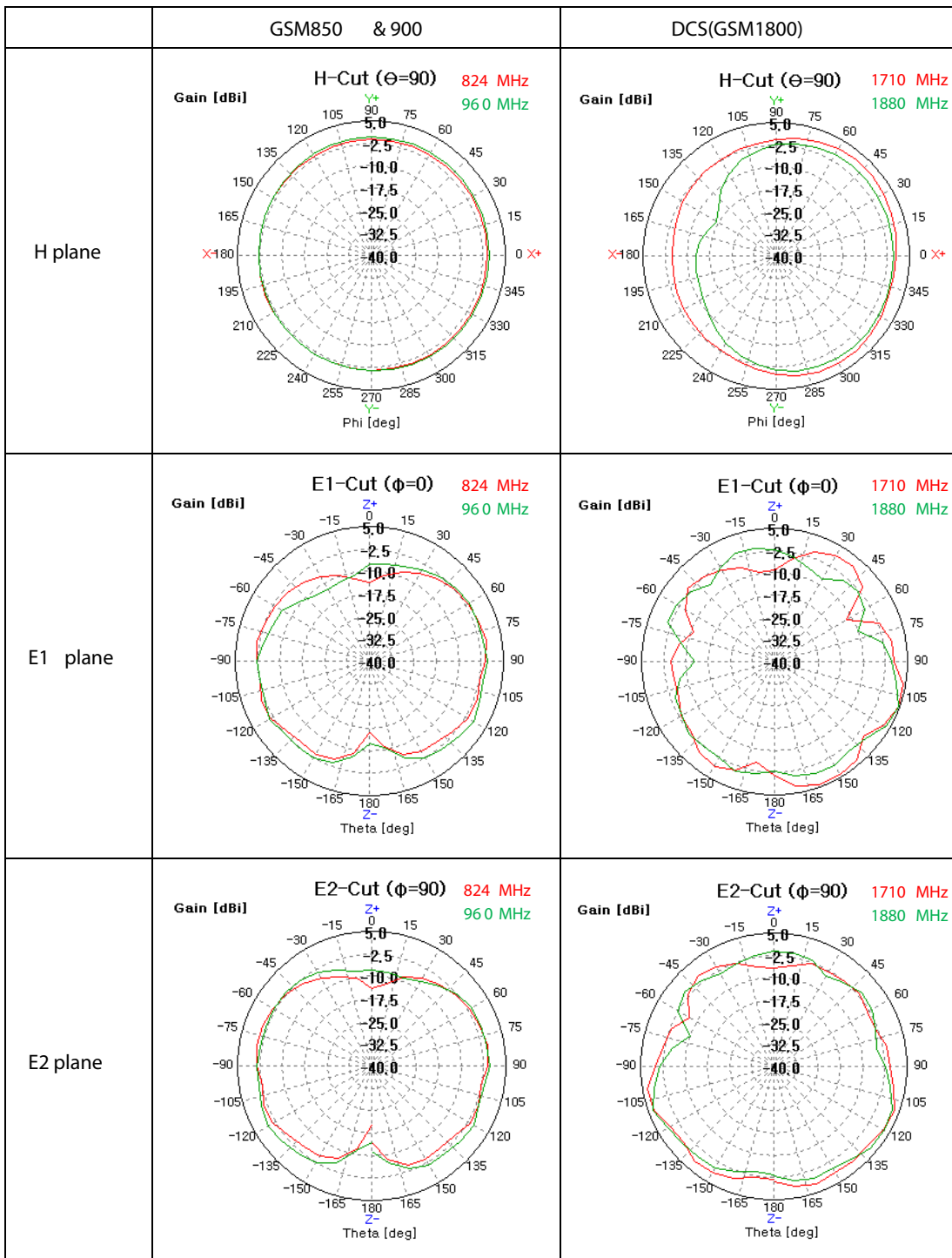

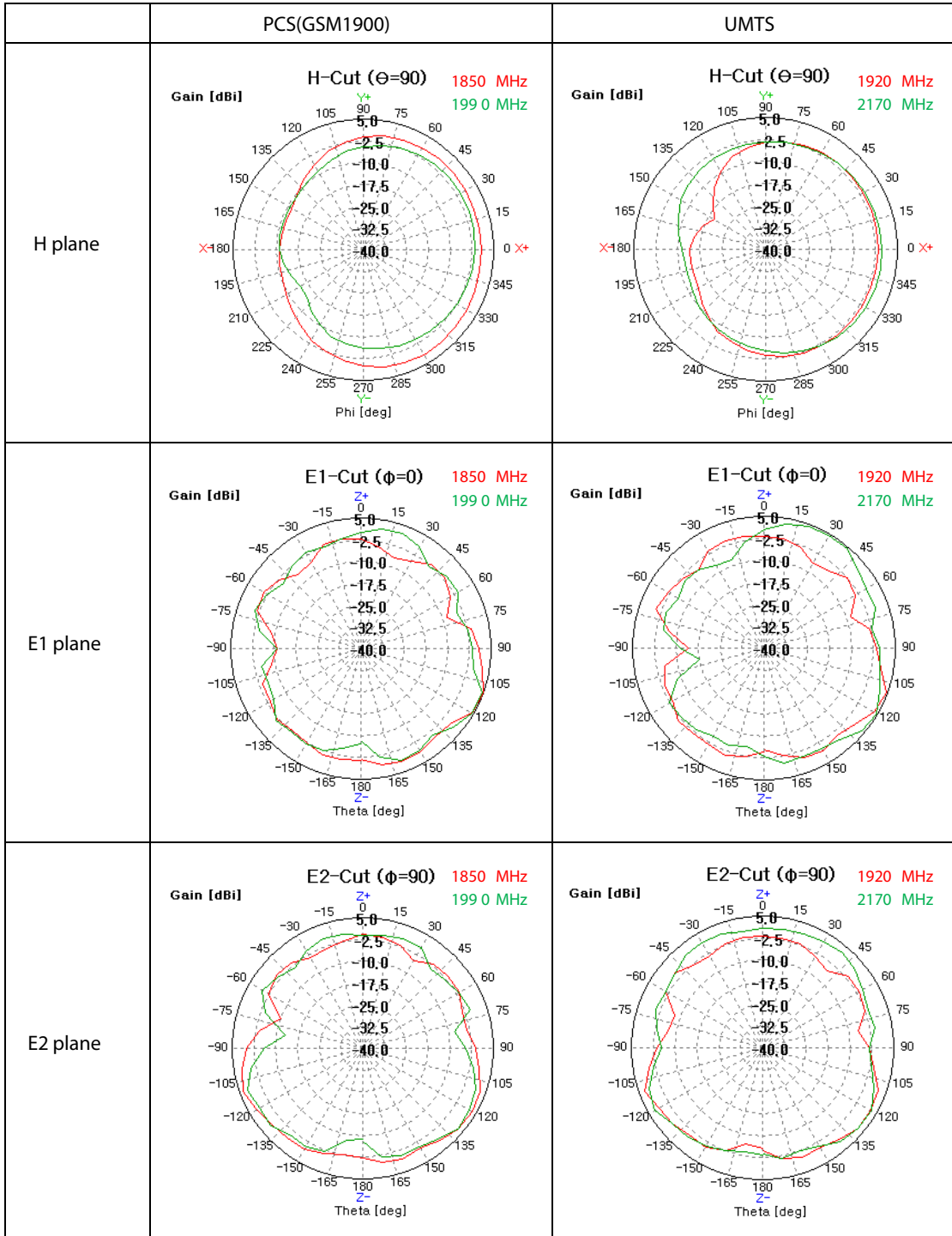

5. PACKING

5.1 Tape Dimension (unit : mm)

5.1.1 Size

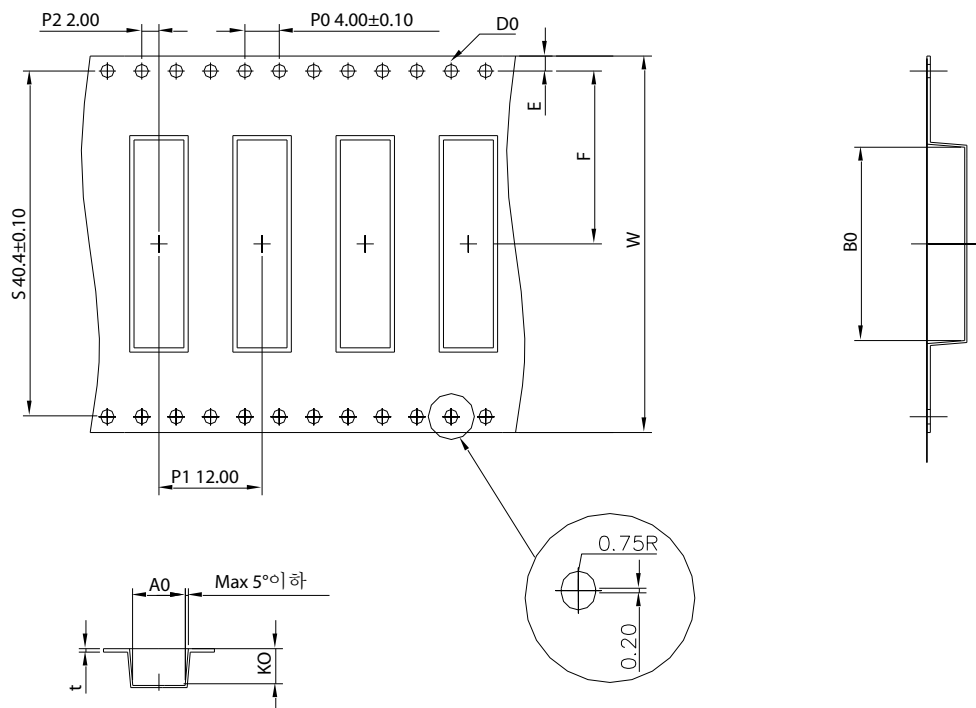

A0	5.80 ± 0.20	E	1.75 ± 0.10
B0	24.30 ± 0.20	F	20.20 ± 0.20
K0	4.60 ± 0.20	W	44.00 ± 0.30
D0	1.55 ± 0.05	t	0.40 ± 0.05

5.1.2 Surface resistance

- 1) Carrier tape : Max $10^{11} \Omega$
- 2) Cover tape : Max $10^{11} \Omega$
- 3) Reel : Max $10^{11} \Omega$

5.2 Description of Reel

5.2.1 Size

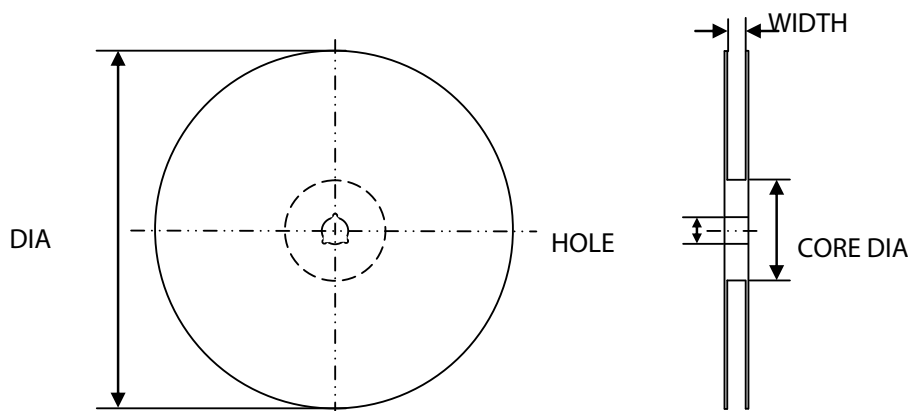

ITEM	DIA	WIDTH	CORE DIA	HOLE
Size(mm)	330.0 +0,-3	45.5 ± 0.3	100.0 ± 1	13.2 ± 0.5

5.2.2 Material

- 1) Plastic reel : GPPS (General Purpose Poly Styrene) resin

5.3 Description of Packing Box

5.3.1 Reel

Size : 44 (W), Dia.Φ330 (mm)

Quantity : 1,000 ea/reel

5.3.1 Inner Box

Size : 350 (W) x 345 (D) x 55 (T) (mm)

Quantity : 1 reel (1,000 ea/reel × 1 reel = 1,000 ea)



5.3.2 Outer Box

Size : 405 (W) x 360 (D) x 300 (T) (mm)

Quantity : 5 Inner Box (1,000 ea/Inner Box × 5 Inner Box=5,000 ea)

X-ON Electronics

Largest Supplier of Electrical and Electronic Components

Click to view similar products for [SIRETTA](#) manufacturer:

Other Similar products are found below :

[ALPHA4A/5M/SMAM/S/S/26](#) [DELTA5A/X/SMAM/S/S/17](#) [OSCAR17/X/TNC/S/S/19](#) [DELTA5A/X/BNCM/S/S/17](#) [SNYPER-LTE-SPECTRUM](#) [ASMA2000F058L13](#) [ASMA2000C058L13](#) [TANGO14/5M/LL/SMAM/S/S/24](#) [TANGO1/1M/FMEF/S/S/4](#) [ASME500F058L13](#) [TANGO3/0.5M/SMAM/S/S/31](#) [TANGO40/X/NTYPEF/S/S/32](#) [QUARTZ-W22-LTE\(EU\)+ACC](#) [ASMA500B174L13](#) [31557](#) [ECHO40/0.1M/UFL/S/S/32](#) [MIKE1A/5M/FMEF/S/S/20](#) [QUARTZ-W22-UMTS\(EU\)+ACC](#) [TANGO11A/2.5M/SMAM/S/S/19](#) [ASMA500F058L13](#) [ZETA-N-UMTS](#) [ECHO11/0.2M/IPEX/S/S/12](#) [ASMA300E174L13](#) [ASMA1000F058L13](#) [DELTA19/X/SMAM/S/S/35](#) [ASMA2000E058L13](#) [ASMZG300F058L13](#) [MIKE3A/5M/SMAM/S/S/17](#) [TANGO15/3M/SMAM/SMAM/S/S/24](#) [TANGO20/3M/SMAM/S/S/26](#) [ASMZG500A058L13](#) [ASMZG1500F058L13](#) [ALPHA1A/2.5M/SMAM/S/S/11](#) [OSCAR40/10M/LL/SMAM/S/S/33](#) [TANGO11A/5M/LL/SMAM/S/S/19](#) [TANGO29/1M/SMAM/RP/S/35](#) [ASME2000F058L13](#) [ASMK015X174S11](#) [LC300-N2-GPRS](#) [DELTA6A/X/SMAM/S/S/11](#) [MIKE1A/2.5M/FMEF/S/S/20](#) [ASMZG1000F058L13](#) [OSCAR41/X/NTYPEF/S/S/29](#) [TANGO22/3M/SMAM/SMAM/SMAM/26](#) [OSCAR420/0.4M/NTYPEF/S/S/19](#) [ASMK010X174S11](#) [ZETA-N2-GPRS](#) [ADAPT/SMAM/RP](#) [OSCAR18/X/NF/S/S/22](#) [TANGO14/3M/SMAM/S/S/24](#)