



Key Features

- Miniature Design: Ø22 x 22mm
- Through Hole / Screw Mounting
- 2.4 to 2.5GHz & 5.1 to 5.9GHz operating frequency
- Gain: 2dBi at 2.4GHz / 4dBi at 5GHz

General Description

The Tango 25A is a miniature through-hole mount, dual band WiFi / WLAN antenna. Measuring at an impressive 22 x 22mm, this is one of the most compact screw mount WiFi antennas on the market. The Tango 25A provides the user with a compact WiFi solution that can be securely fixed to its mounting surface. Despite a compact size, this antenna provides great WiFi performance for improved WiFi signal transmission and reception. This all lends a hand into making the Tango 25A ideal for WiFi applications that require a covert solution that is not going to draw attention to it. Furthermore, this is a dual band WiFi antenna, providing compatibility with modems that operate on the more common 2.4GHz as well as the modern, less congested 5GHz frequency band.

The Tango 25A is tuned to operate within the 2.4 to 2.5GHz and 5.1 to 5.9GHz frequencies, making this antenna perfect for WiFi, Bluetooth and Zigbee applications and also those that operate on the 5GHz band. A peak gain of 2dBi on the 2.4 to 2.5GHz band, and 4dBi on the 5.1 to 5.9GHz band, helping to improve the short range signal transmission/reception of: WiFi modems, Bluetooth gadgets or even your low power ZigBee sensor.

The Tango 25A is supplied, as standard, with 100mm of RG174 coaxial cable, terminated with a reverse polarity SMA male connector. Custom cable lengths and alternative connector types can be supplied for volume requirements.

Additional Considerations

- Dual Band operating frequency allows usage with dual band modems
- Made out of durable ABS for long lasting antenna
- Supplied with a short cable to allow flexible mounting positioning
- 8mm long screw thread for secure through-hole mounting
- RoHS Compliant

Rev 1.2

Electrical Specifications

Operating temperature:	-30 to +60°C
Impedance:	50 ± 5ohm
Gain:	2/4dBi
VSWR:	≤ 2.0
Frequency range:	2.4 - 2.5 / 5.1 - 5.9GHz
Max power:	1 Watt
Isolation:	NA
Beamwidth:	H-PLANE - 360° E-PLANE - 30/22°
Polarization:	Vertical

Gain

WiFi

2400MHz	2.43dBi
2500MHz	1.97dBi

Mechanical Specifications

Dimensions:	Ø22 x 22mm
Weight:	11 ± 2g
Connector:	RP SMA Male
Cable:	100mm RG174 coaxial
RoHS compliant:	Yes

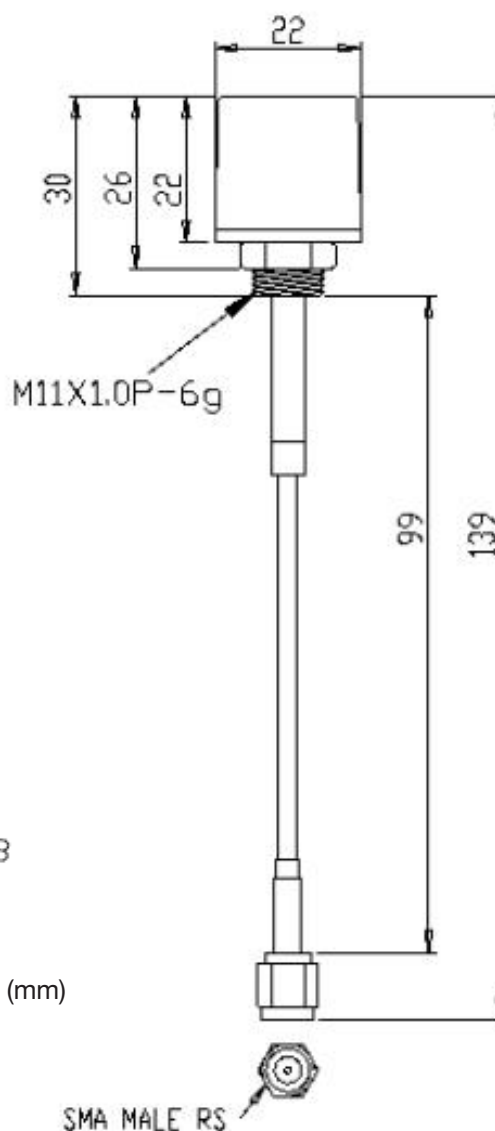

Recommended panel hole cutout (mm)

Test Reports

VSWR

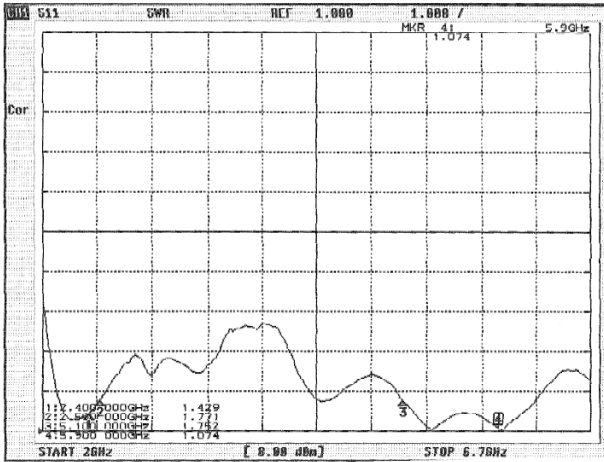

S11

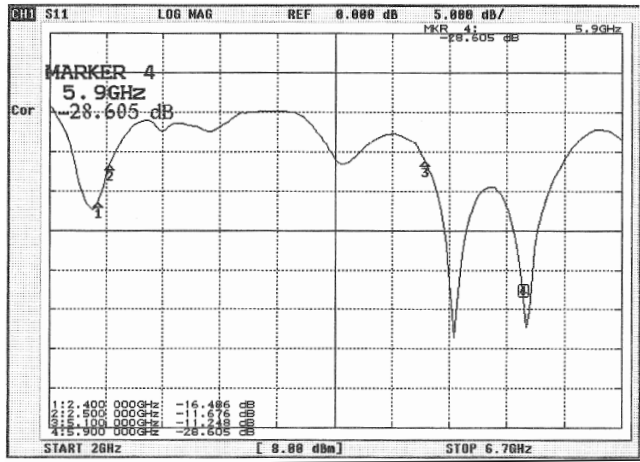

Radiation Patterns

2.4G H Plane

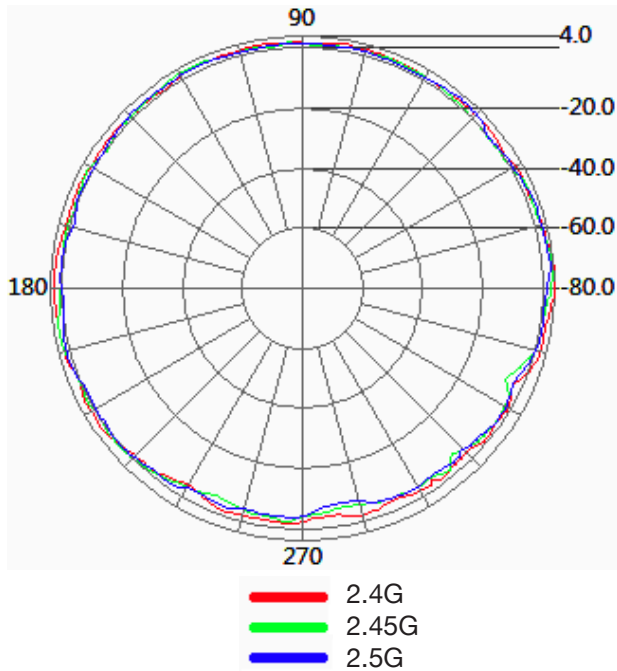

2.4G E Plane

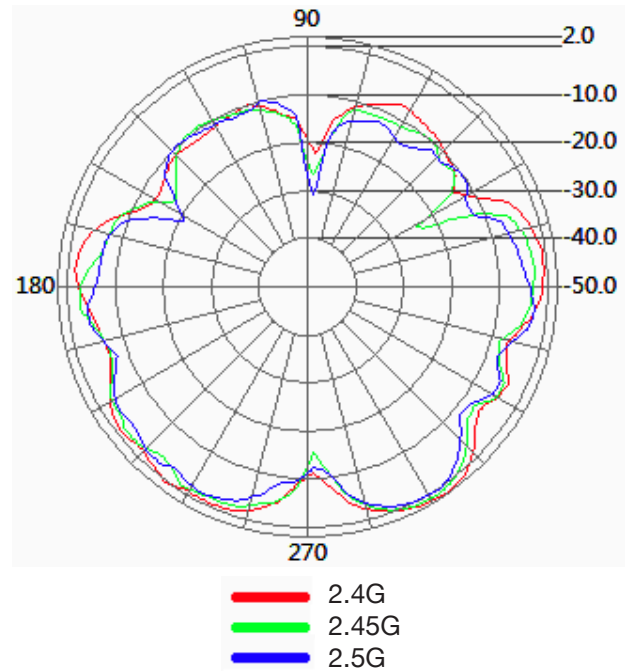

Tango 25A

Miniature Dual Band WiFi Through Hole Mount Antenna

5G H Plane

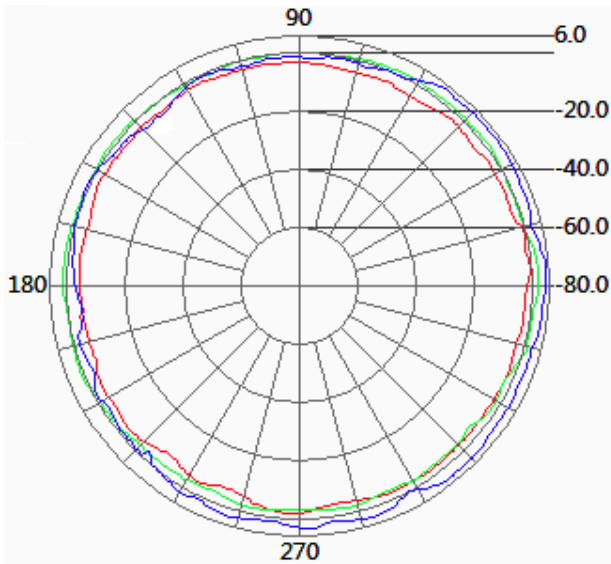

— 2.4G
— 2.45G
— 2.5G

5G E Plane

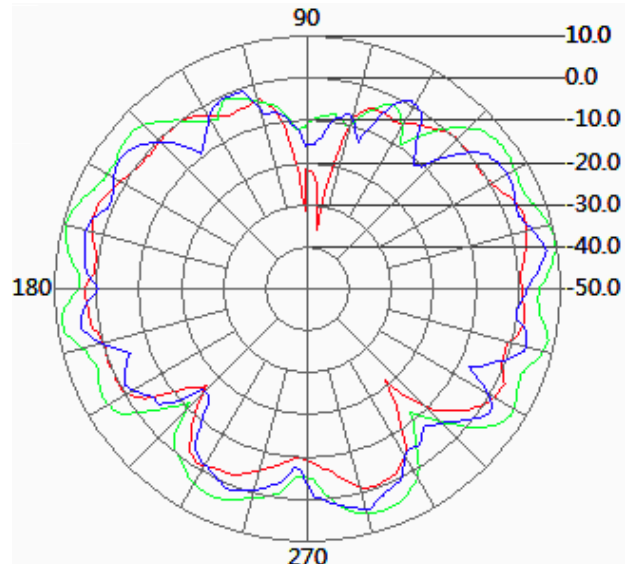

— 2.4G
— 2.45G
— 2.5G

Gain vs. Frequency Graph

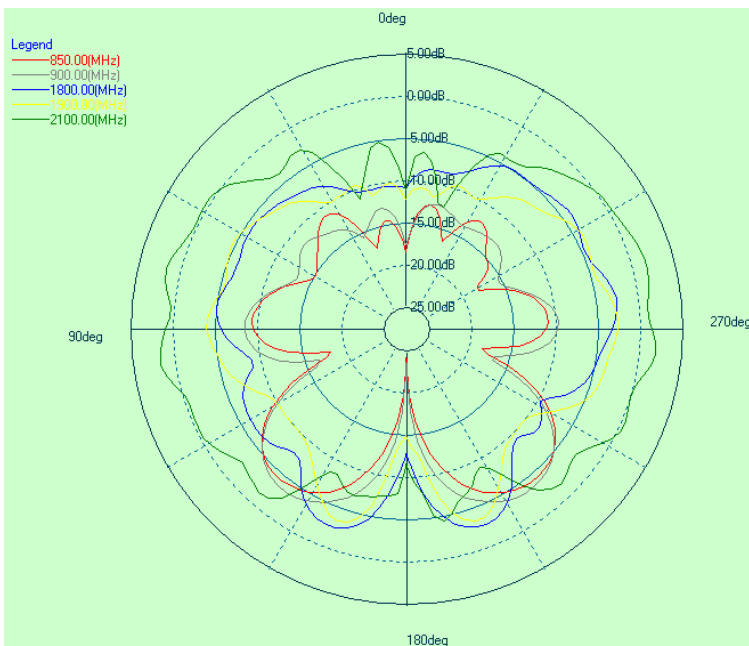

UL Tested (Basingstoke, UK)
Part: TANGO25A/0.1M/SMAM/S/RP/29

X-ON Electronics

Largest Supplier of Electrical and Electronic Components

Click to view similar products for [SIRETTA](#) manufacturer:

Other Similar products are found below :

[ALPHA4A/5M/SMAM/S/S/26](#) [DELTA5A/X/SMAM/S/S/17](#) [OSCAR17/X/TNC/S/S/19](#) [DELTA5A/X/BNCM/S/S/17](#) [SNYPER-LTE-SPECTRUM](#) [ASMA2000F058L13](#) [ASMA2000C058L13](#) [TANGO14/5M/LL/SMAM/S/S/24](#) [TANGO1/1M/FMEF/S/S/4](#) [ASME500F058L13](#) [TANGO3/0.5M/SMAM/S/S/31](#) [TANGO40/X/NTYPEF/S/S/32](#) [QUARTZ-W22-LTE\(EU\)+ACC](#) [ASMA500B174L13](#) [31557](#) [ECHO40/0.1M/UFL/S/S/32](#) [MIKE1A/5M/FMEF/S/S/20](#) [QUARTZ-W22-UMTS\(EU\)+ACC](#) [TANGO11A/2.5M/SMAM/S/S/19](#) [ASMA500F058L13](#) [ZETA-N-UMTS](#) [ECHO11/0.2M/IPEX/S/S/12](#) [ASMA300E174L13](#) [ASMA1000F058L13](#) [DELTA19/X/SMAM/S/S/35](#) [ASMA2000E058L13](#) [ASMZG300F058L13](#) [MIKE3A/5M/SMAM/S/S/17](#) [TANGO15/3M/SMAM/SMAM/S/S/24](#) [TANGO20/3M/SMAM/S/S/26](#) [ASMZG500A058L13](#) [ASMZG1500F058L13](#) [ALPHA1A/2.5M/SMAM/S/S/11](#) [OSCAR40/10M/LL/SMAM/S/S/33](#) [TANGO11A/5M/LL/SMAM/S/S/19](#) [TANGO29/1M/SMAM/RP/S/35](#) [ASME2000F058L13](#) [ASMK015X174S11](#) [LC300-N2-GPRS](#) [DELTA6A/X/SMAM/S/S/11](#) [MIKE1A/2.5M/FMEF/S/S/20](#) [ASMZG1000F058L13](#) [OSCAR41/X/NTYPEF/S/S/29](#) [TANGO22/3M/SMAM/SMAM/SMAM/26](#) [OSCAR420/0.4M/NTYPEF/S/S/19](#) [ASMK010X174S11](#) [ZETA-N2-GPRS](#) [ADAPT/SMAM/RP](#) [OSCAR18/X/NF/S/S/22](#) [TANGO14/3M/SMAM/S/S/24](#)