



Siretta

inspired wireless technology



SNYPER 2G & 3G

Cellular Signal and Network Analyser

User Manual

Rev 1.5

Table of Contents

	Page		
Introduction	3	About Menu	36
About Siretta	4	SNYPER Antenna	37
SNYPER Overview	5	Using Other Antennas with the SNYPER	37
What's in the Box	5	Safety Product and Care	38
Part Numbers	5	General Precautions	38
General Description	5	Exposure to RF Energy	38
Features	6	Safety Recommendations	40
Specifications	7	Conformity Assessment	41
SNYPER Product Images	8	Disclaimer	42
SNYPER Dimensions	11	Definitions	43
Powering the SNYPER	12		
Power On	12		
Charging and Battery Status	13		
Main Menu	14		
Power Off	15		
Saved Results Menu	16		
Viewing Saved Survey Results	17		
Viewing Saved Summary Results	18		
Survey Menu	21		
Viewing Current Survey	21		
Performing a Survey	23		
Viewing Survey Results	24		
Summary Menu	25		
Saving a Survey	28		
SNYPER Setup Menu	29		
Saving Setup Preferences	30		
Software Options Menu	31		
ADV Option	32		
Restoring to Factory Default	34		
Saving Option Preferences	35		

Introduction

This document is intended to explain how to use the SNYPER to survey network signals.

The SNYPER is a range of GSM and UMTS cellular signal analysers, designed for surveying wireless systems.

This document discusses the modes of operation and device states, in addition to the electrical characteristics of the device interfaces.

The screen views and operation of the SNYPER-3G is referred to throughout this document, however all steps and information are relevant to the SNYPER-2G. The SNYPER range are identical in functionality, except from the SNYPER-2G is only GSM compatible, whereas the SNYPER-3G is GSM and UMTS compatible.

About Siretta

Siretta, located in Reading, United Kingdom have been manufacturing antennas, cable assemblies and cellular terminals for over 10 years. We supply our products globally to many of the world's leading organisations.

Whether you require an off the shelf or custom solution, Siretta has a wide portfolio of antenna, RF cable assemblies and terminals to fit your application.

Our extensive knowledge and experience in the wireless market allows us to support a wide range of customer applications, focusing on frequencies typically within the 75MHz - 5.8GHz range. These encompass the HF, VHF, ISM, GSM/GPRS/3G/4G and GPS frequencies as well as industrial WLAN and VHF/UHF antenna/Wi-Fi antenna solutions.

With a heavy emphasis on design, we have a team of dedicated Application Engineers and Product Managers, backed up by Field Sales Engineers, who specialise in wireless applications.

We have made significant investments in R&D facilities which boast GPS hardware development equipment and a GSM Pico Cell on site, as well as development software and a comprehensive suite of Industrial, Scientific and Medical band, and non ISM band frequency products. We have many technology partners enabling us to keep at the forefront of the communications industry and offer class leading wireless solutions.

SNYPER Overview

What's in the Box?

As standard, the SNYPER comes with the following:*

- » SNYPER signal and network analyser
- » Multi region power supply
- » Antenna
- » Hard carrying case
- » Quick start guide

Part Numbers

The SNYPER range is available in 2 variants:

- » **SNYPER-2G** - High Performance 2G / GPRS Signal and Network Analyser
- » **SNYPER-3G** - High Performance 2G / GPRS and 3G / UMTS Signal and Network Analyser

General Description

The SNYPER is a high performance cellular signal and network analyser for the 2G / GPRS and 3G / UMTS networks.

The SNYPER can perform a number of different functions to determine optimum antenna placement, performance of existing installations or choice of network operator. As an example, the SNYPER can determine the strength of a particular network signal, or can review all available network signals in the area of use and rank these in order of received signal strength through its summary page.

The SNYPER has been designed to be as logical and intuitive as possible, with a simple to use menu and operation system. Provided with a large high contrast LCD display, the SNYPER ensures that all information is clearly visible, and allows for the presentation of considerable data at the same time.

All of these features combined make the SNYPER one of the most powerful signal and network analysers available today, guaranteed to enhance your application.

*For replacement parts, please contact your Siretta representative or call us on +44 (0)118 976 9014

Features

The SNYPER has the following features:

- » Measures and displays received network signal strength
- » Summary view detailing of all networks in range
- » Intuitive and powerful menu system
- » Most recent survey analysis stored internally
- » Large full colour portrait LCD screen
- » Robust enclosure for rugged and continuous use
- » Long life rechargeable battery gives up to 48 hours use on one charge
- » Configurable 'auto-off' feature
- » Supplied in a convenient hard carrying case with mains charger, antenna and quick start guide

Specifications

Table 1. Specifications of SNYPER

	SNYPER-2G	SNYPER-3G
2G supported bands:	850, 900, 1800, 1900MHz	850, 900, 1800, 1900MHz
3G supported bands:	-	900, 2100MHz
Dimensions:	141 x 76 x 36mm	141 x 76 x 36mm
Weight:	215g	215g
Antenna dimensions:	78 x 11mm	78 x 11mm
Operating temperature range:	-20 to +75°C	-20 to +75°C
Storage temperature range:	-40 to +85°C	-40 to +85°C
Operating humidity range:	0 to 90% RH non-condensing	0 to 90% RH non-condensing
Antenna connector:	SMA male	SMA male
Display:	2.4" QVGA 320 x 240 RGB TFT	2.4" QVGA 320 x 240 RGB TFT
Battery life:	48 hours normal use*	48 hours normal use*
Battery:	2000mAh	2000mAh
Warm up time:	2s	2s
Mains adapter input:	100 - 240V 50/60Hz	100 - 240V 50/60Hz
Mains adapter connector:	3 pin UK, 2 pin EU, US, AU	3 pin UK, 2 pin EU, US, AU
Charger output:	5V DC 2000mA	5V DC 2000mA
Charger connector:	USB Mini-B	USB Mini-B

*Based on 20 surveys in each 24 hours with automatic power off enabled

SNYPER Product Images

Figure 1. Front view of the SNYPER



Figure 2. Bottom view of the SNYPER

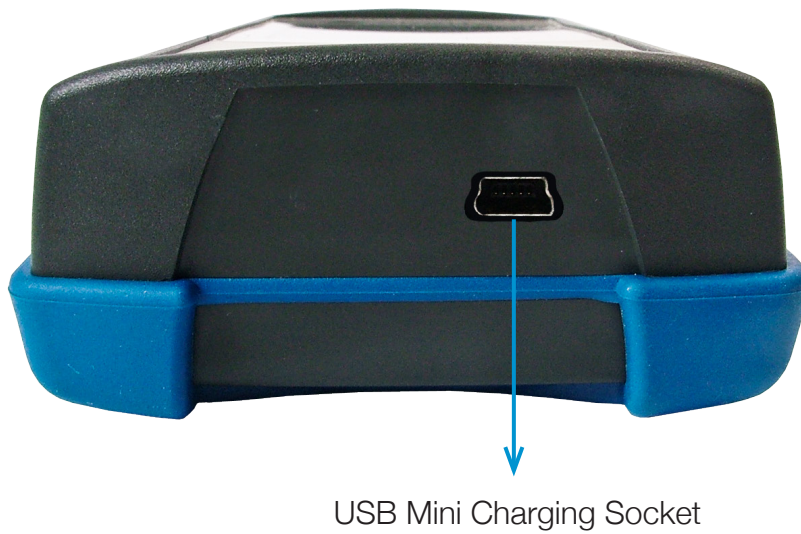

Figure 3. Top view of the SNYPER (Without antenna)

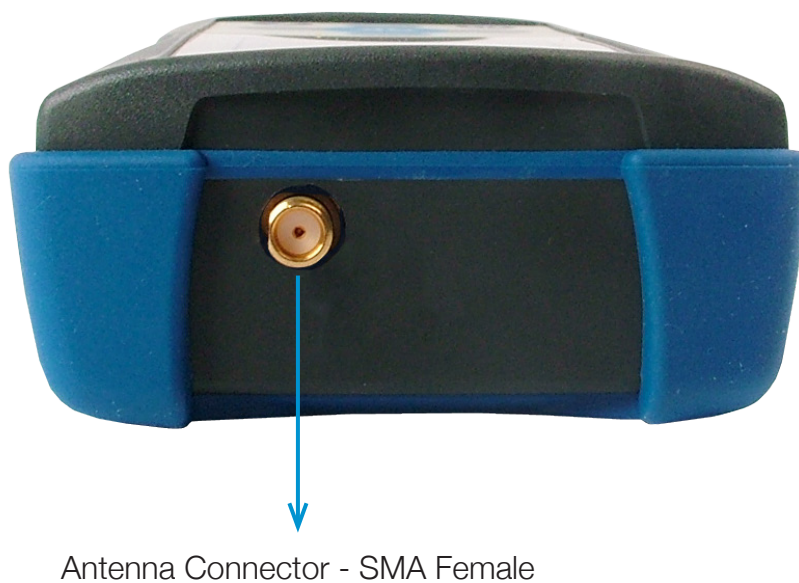

Figure 4. Rear view of the SNYPER



SNYPER Dimensions

The SNYPER dimensions are measured in mm.

Figure 5. SNYPER front view dimensions

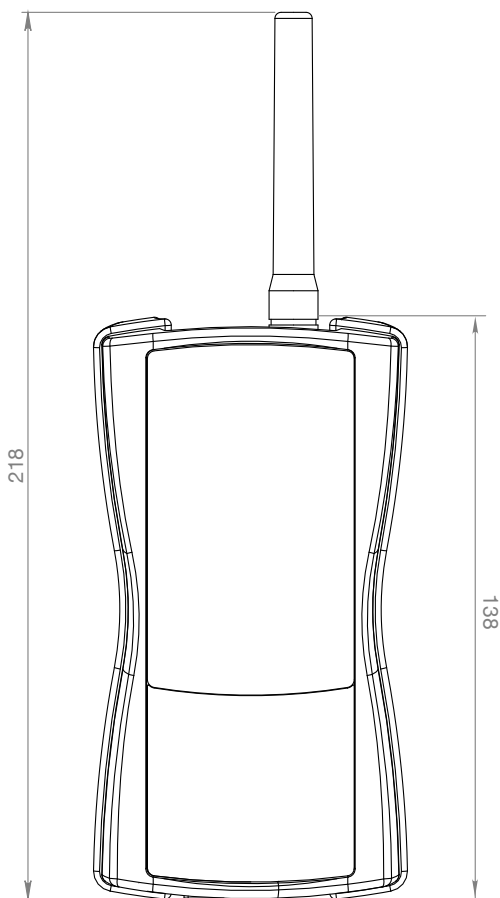

Figure 6. SNYPER side view dimensions

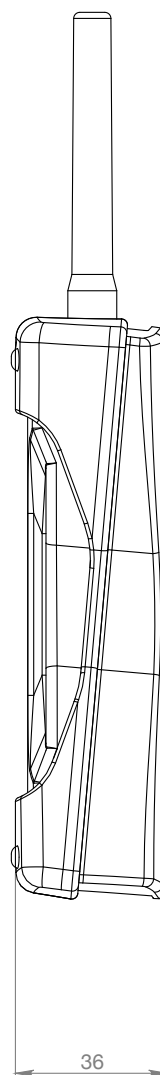
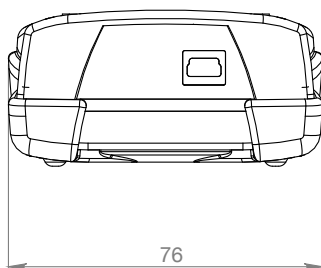

Figure 7. SNYPER bottom view dimensions



Powering the SNYPER

Power On

- » The SNYPER needs to be charged using the mains adaptor for at least 2 hours before use. The SNYPER does **not** need a SIM card to perform network and signal tests.
- » Ensure the antenna is screwed firmly into place on the SNYPER and isn't loose.
- » To power up the SNYPER press the ON/OFF button. A welcome screen will be displayed briefly (as shown below in figure 9) before the main menu is displayed (as shown over page in figure 10.)

Figure 8. ON/OFF button



Figure 9. Power on message



Charging and Battery Status

Approximately 4 - 6 hours are needed to fully charge the unit using the default fast charging mode.

Figure 10. Charging and battery status

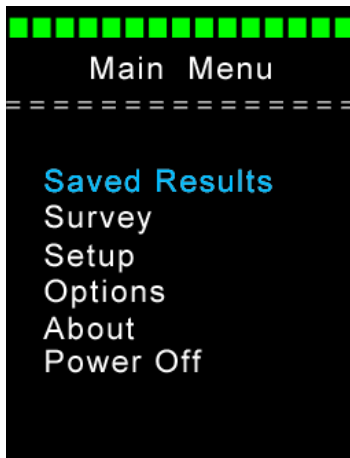

Charging and battery status bar:

During charging, the number of bars will increase and turn from red, to yellow, to green. The charge status LED will be red.

A full line of green bars indicates that the unit is fully charged.

During use, the number of bars will decrease and turn from green, to yellow, to red.

Recharging is recommended once red bars are displayed on the SNYPER battery status bar.

If the SNYPER drops below allowable low battery usage the unit will switch off and charging will be required. At power on, if the battery is below allowable low battery usage a low battery indicator will be displayed as shown below in figure 11.

NOTE - During low power charge the SNYPER will display the battery screen (as shown below in figure 12) until the SNYPER has enough power to be used.

Figure 11. Low battery screen

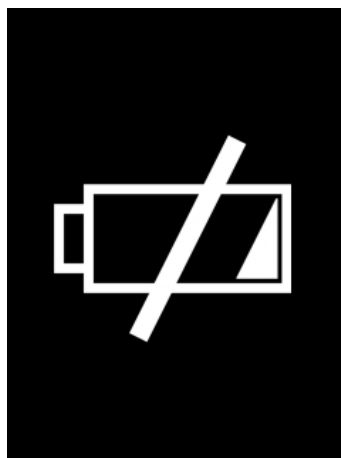
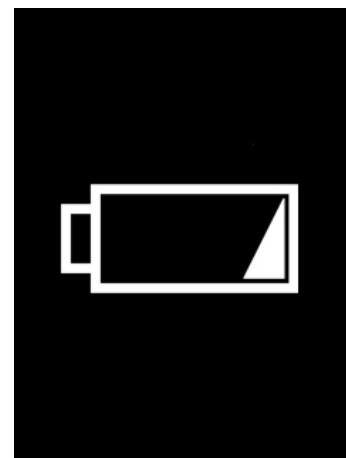

Figure 12. Low power charge screen



Main Menu

The SNYPER main menu has 6 menus (as shown below in **figure 13**), these can be selected using the UP/DOWN buttons. Once the chosen menu is highlighted, click OK. Press the BACK button to return to the main menu.

Figure 13. 'Main Menu' screen

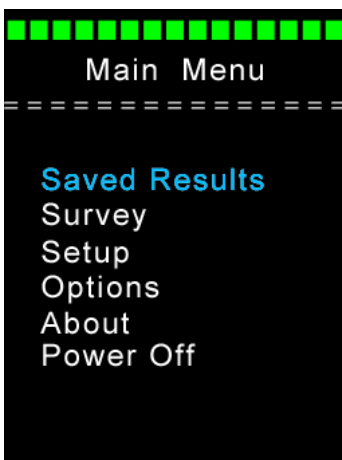

Saved Results

Saved Results: Reviews previously saved survey.

Survey

Survey: Used to perform a new survey.

Setup

Setup: Basic setups of the SNYPER.

Options

Options: User options for the SNYPER.

About

About: Displays information about the SNYPER.

Power Off

Power Off: Powers off the SNYPER.

Power Off

After use, remember to power off the SNYPER. The SNYPER can be powered off in the following 2 ways:

- » Selecting the 'Power Off' option from the main menu. The SNYPER will display a power off message as shown below in figure 15.

Figure 14. Select 'Power Off'

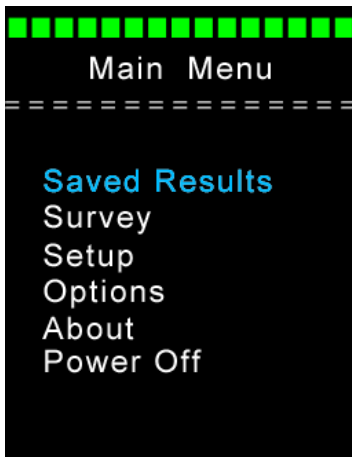

Figure 15. Power off message



- » Press and hold the ON/OFF button on the SNYPER for >2 seconds. The SNYPER will display a power off message as shown below in figure 17.

Figure 16. ON/OFF button



Figure 17. Power off message



Saved Results Menu

The 'Saved Results' menu allows you to review the last saved survey results on the SNYPER.

Figure 18. 'Saved Results' screen

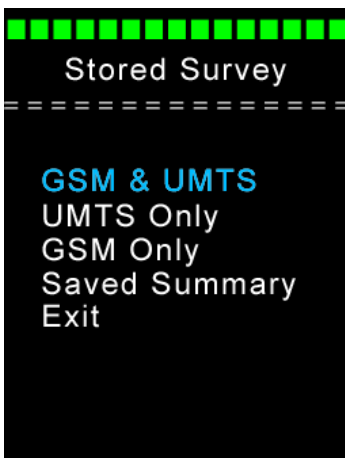

GSM & UMTS

GSM & UMTS: Displays saved GSM & UMTS survey results.

UMTS Only

UMTS Only: Displays saved UMTS survey results.

GSM Only

GSM Only: Displays saved GSM survey results.

Saved Summary

Summary: Displays a summary of signal strengths from the saved survey.

Exit

Exit: Returns to the SNYPER main menu.

Viewing Saved Survey Results

Step 1. From the 'Saved Results' menu, select the saved results that you require to be displayed (GSM & UMTS / GSM Only / UMTS Only).

NOTE - To switch between all saved signals, use the LEFT/RIGHT buttons (LEFT displays stronger signal, RIGHT displays weaker signal).*

Figure 19. Strongest saved signal

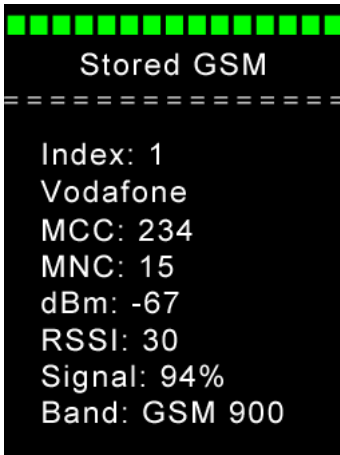
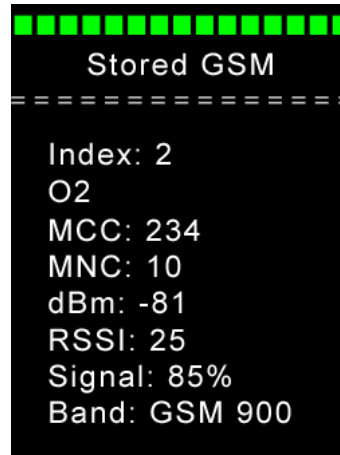

Figure 20. Next strongest saved signal



Press the back button to return to the 'Saved Results' menu.

*See section 'ADV Option' on page 32 for information about the displayed results.

Viewing Saved Summary Results

By selecting 'Summary' from the 'Current Survey' menu, a summary of all network signals detected in the survey will be displayed. Results are displayed in order of strength within signal strength bands across different screens.

To display higher or lower signal strengths received on the SNYPER, click the LEFT/RIGHT buttons (LEFT displays higher signal strengths, RIGHT displays lower signal strength). The signal strengths are displayed in 15% steps, decreasing in signal strength from 85% to 10%.

NOTE - To display a summary of GSM or UMTS results, click the UP/DOWN buttons to scroll between GSM and UMTS network list.

The example in **table 2** below shows the following:

- » A Vodafone cell had the strongest signal sensed in the area
- » O2, T-Mobile and Orange cells were sensed at a weaker strength

Table 2. Summary of network signals

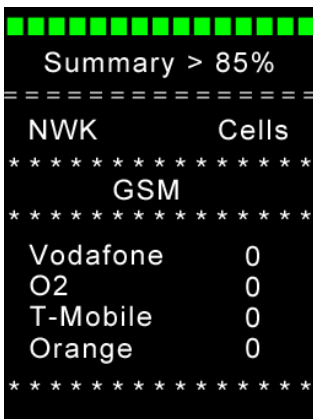

NWK	Cells
GSM	
Vodafone	0
O2	0
T-Mobile	0
Orange	0

85% Signal Strength

The SNYPER is displaying all 2G networks that were received at 85%.

At this level, none of the networks had cells with this signal strength.

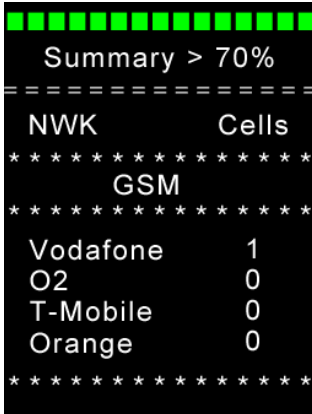

Summary > 70%	
NWK	Cells
GSM	
Vodafone	1
O2	0
T-Mobile	0
Orange	0

70% Signal Strength

The SNYPER is displaying all 2G networks that were received at 70%.

At this level, Vodafone had 1 cell being received.

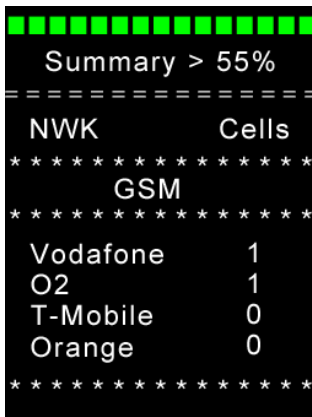

Summary > 55%	
NWK	Cells
GSM	
Vodafone	1
O2	1
T-Mobile	0
Orange	0

55% Signal Strength

The SNYPER is displaying all 2G networks that were received at 55%.

At this level, O2 had 1 cell being received.

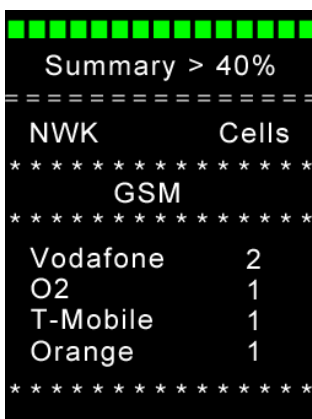

Summary > 40%	
NWK	Cells
GSM	
Vodafone	2
O2	1
T-Mobile	1
Orange	1

40% Signal Strength

The SNYPER is displaying all 2G networks that were received at 40%.

At this level, 1 additional Vodafone cell was being received at a weaker strength than the previous cell received.

There was also 1 T-Mobile cell and 1 Orange cell that were being received at this signal strength.

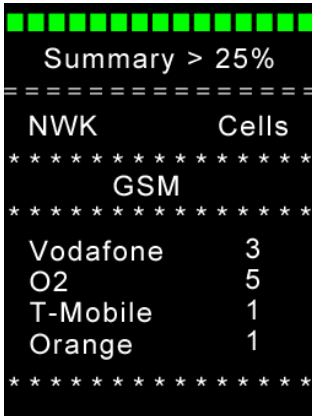

Summary > 25%

NWK	Cells
GSM	
Vodafone	3
O2	5
T-Mobile	1
Orange	1

25% Signal Strength

The SNYPER is displaying all 2G networks that were received at 25%.

At this level, 1 additional Vodafone cell and 4 additional O2 cells were being received at a weaker strength than the previous cells received.

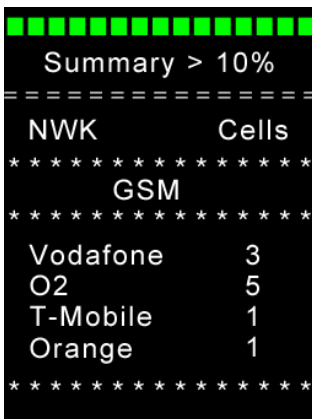

Summary > 10%

NWK	Cells
GSM	
Vodafone	3
O2	5
T-Mobile	1
Orange	1

10% Signal Strength

The SNYPER is displaying all 2G networks that were received at 10%.

At this level, there were no further cells being received by the SNYPER.

Press the back button to return to the 'Saved Results' menu.

Survey Menu

The 'Survey' menu allows you to review a current survey or perform a new survey.

Figure 21. 'Survey' screen

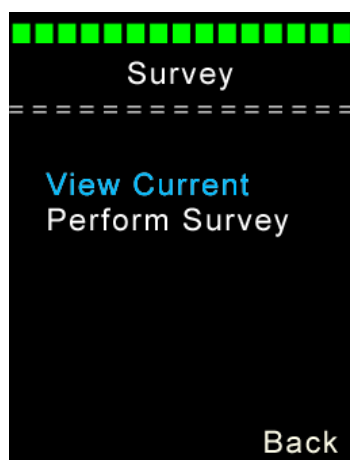

View Current

View Current: Displays most recently performed survey.

Perform Survey

Perform Survey: Performs a survey on the SNYPER.

Viewing Current Survey

Step 1. To view the most recently performed survey* on the SNYPER, select 'View Current' from the 'Survey Menu'. The 'Current Survey' screen will be displayed, as shown below in figure 22. If there are no current survey results available, the SNYPER will display a message as shown below in figure 23.

Figure 22. 'Stored Survey' screen

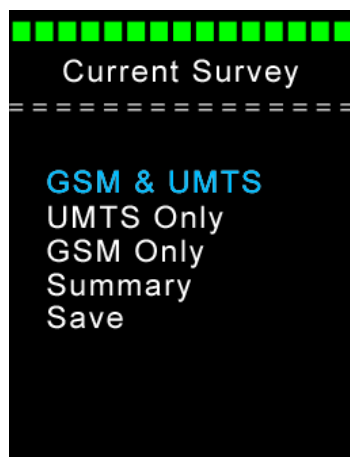

Figure 23. No current survey results available



*The most recently performed survey is available until the SNYPER is powered off.

Step 2. From the 'Current Survey' menu, select the results that you require to be displayed (GSM & UMTS / GSM Only / UMTS Only).

NOTE - To switch between all signals found in the survey, use the LEFT/RIGHT buttons (LEFT displays stronger signal, RIGHT displays weaker signal).*

Figure 24. Strongest signal found in the survey

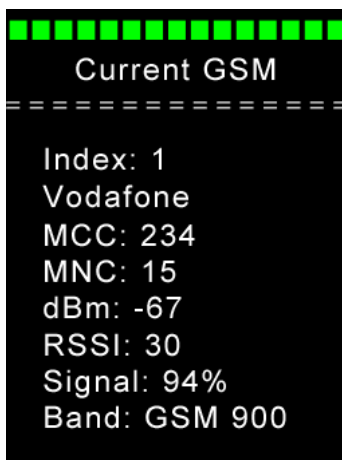
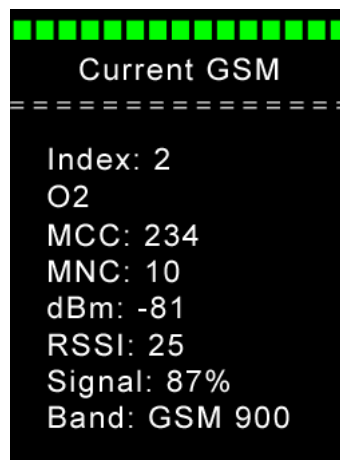

Figure 25. Next strongest signal found in the survey



Press the back button to return to the 'Current Survey' menu.

*See section 'ADV Option' on page 32 for information about the displayed results.

Performing a Survey

Step 1. Select 'Perform Survey' from the 'Survey' menu, this will automatically begin a new survey. Whilst the survey is being performed, the SNYPER will display a sequence of messages as shown below in figures 26 - 28.

Figure 26. Initialising survey

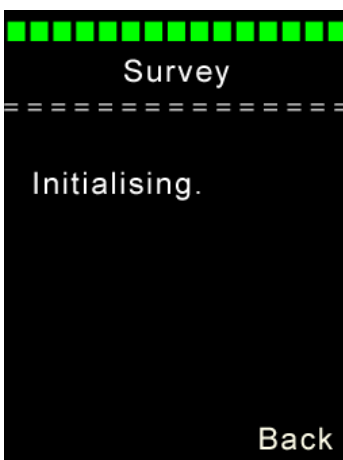

Figure 27. Performing survey

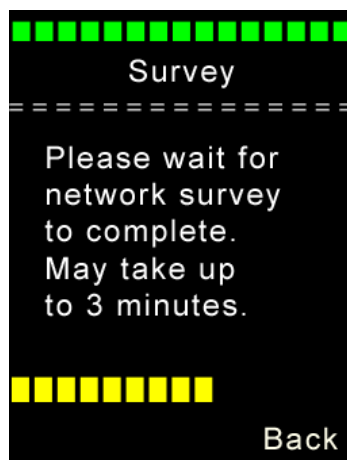
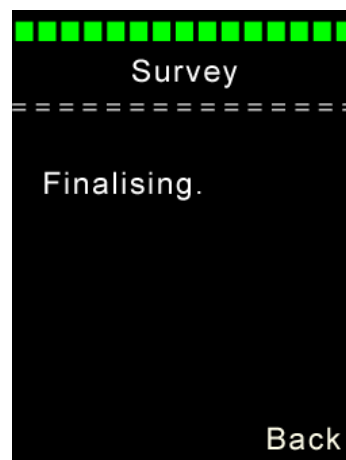
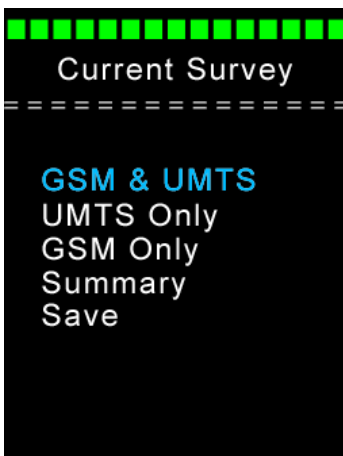

Figure 28. Finalising survey



Step 2. Once the survey is complete, the screen will display a 'Current Survey' menu as shown below in figure 29. The 'Current Survey' menu has 5 menus, these are selected using the UP/DOWN buttons. Once the chosen sub menu is highlighted, click OK.

Figure 29. 'Current Survey' screen



GSM & UMTS

GSM & UMTS: Displays GSM & UMTS survey results.

UMTS Only

UMTS Only: Displays UMTS survey results.

GSM Only

GSM Only: Displays GSM survey results.

Summary

Summary: Displays a summary of signal strengths from the survey.

Save

Save: Saves the results of the performed survey.

Viewing Survey Results

Step 1. From the 'Current Survey' menu, select the results that you require to be displayed (GSM & UMTS / GSM Only / UMTS Only).

NOTE - To switch between all signals found in the survey, use the LEFT/RIGHT buttons (LEFT displays stronger signal, RIGHT displays weaker signal).*

Figure 30. Strongest signal found in the survey

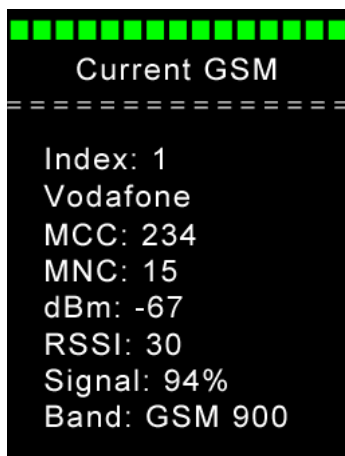
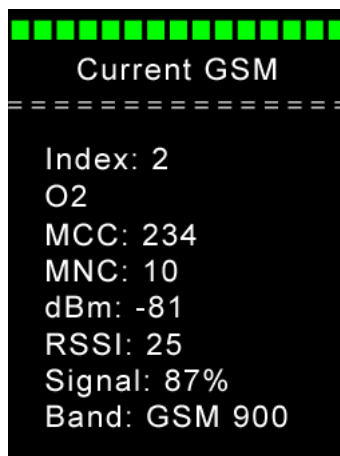

Figure 31. Next strongest signal found in the survey



Press the back button to return to the 'Current Survey' menu.

*See section 'ADV Option' on page 32 for information about the displayed results.

Summary Menu

By selecting 'Summary' from the 'Current Survey' menu, a summary of all network signals detected in the survey will be displayed. Results are displayed in order of strength within signal strength bands across different screens.

To display higher or lower signal strengths received on the SNYPER, click the LEFT/RIGHT buttons (LEFT displays higher signal strengths, RIGHT displays lower signal strength). The signal strengths are displayed in 15% steps, decreasing in signal strength from 85% to 10%.

NOTE - To display a summary of GSM or UMTS results, click the UP/DOWN buttons to scroll between GSM and UMTS network list.

The example in **table 3** below shows the following:

- » A Vodafone cell had the strongest signal sensed in the area
- » O2, T-Mobile and Orange cells were sensed at a weaker strength

Table 3. Summary of network signals

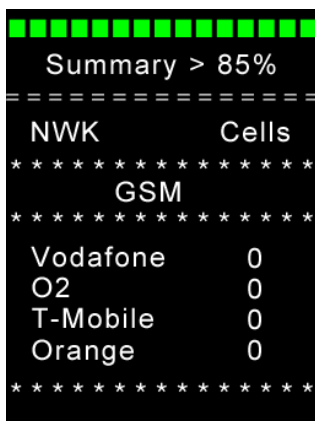

NWK	Cells
GSM	
Vodafone	0
O2	0
T-Mobile	0
Orange	0

85% Signal Strength

The SNYPER is displaying all 2G networks being received at 85%.

At this level, none of the networks have cells with this signal strength.

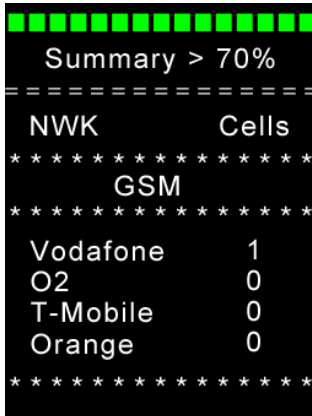

```

Summary > 70%
=====
NWK      Cells
*****
GSM
*****
Vodafone  1
O2         0
T-Mobile  0
Orange    0
*****
  
```

70% Signal Strength

The SNYPER is displaying all 2G networks being received at 70%.

At this level, Vodafone shows 1 cell being received.

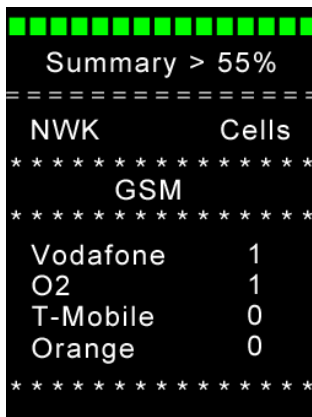

```

Summary > 55%
=====
NWK      Cells
*****
GSM
*****
Vodafone  1
O2         1
T-Mobile  0
Orange    0
*****
  
```

55% Signal Strength

The SNYPER is displaying all 2G networks being received at 55%.

At this level, O2 now shows 1 cell being received.

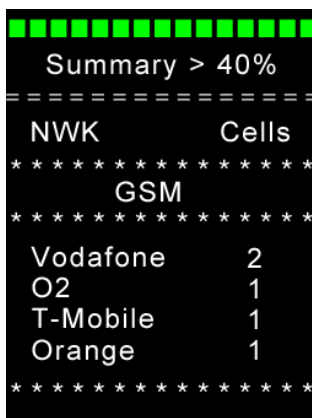

```

Summary > 40%
=====
NWK      Cells
*****
GSM
*****
Vodafone  2
O2         1
T-Mobile  1
Orange    1
*****
  
```

40% Signal Strength

The SNYPER is displaying all 2G networks being received at 40%.

At this level, there is 1 additional Vodafone cell being received at a weaker strength than the previous cell received.

There is also 1 T-Mobile cell and 1 Orange cell being received at this signal strength.

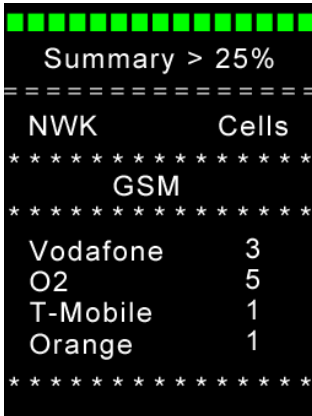

Summary > 25%	
NWK	Cells
GSM	
Vodafone	3
O2	5
T-Mobile	1
Orange	1

25% Signal Strength

The SNYPER is displaying all 2G networks being received at 25%.

At this level, there is 1 additional Vodafone cell and 4 additional O2 cells being received at a weaker strength than the previous cells received.



Summary > 10%	
NWK	Cells
GSM	
Vodafone	3
O2	5
T-Mobile	1
Orange	1

10% Signal Strength

The SNYPER is displaying all 2G networks being received at 10%.

At this level, there are no further cells being received by the SNYPER.

Press the back button to return to the 'Current Survey' menu.

Saving a Survey

Step 1. Once you have performed a survey, you can save the results by selecting 'Save' from the 'Current Survey' menu.*

Step 2. Once the 'Save' option is highlighted, you will be prompted to select 'YES' to confirm the save, or 'NO' to cancel the save. Whilst results are being saved, a message will be displayed as shown below in **figure 32**.

Figure 32. Saving survey results to the SNYPER



Once the survey has been stored, the SNYPER will return to the main menu. To review the saved survey, see section 'Saved Results Menu' on **page 16**.

NOTE - The SNYPER can only store results from 1 survey. Therefore when saving a survey, the last saved survey will be overwritten.

*The SNYPER doesn't automatically save survey results, if you wish to save results from a survey follow steps 1 and 2 above. If you do not wish to save results from a survey, return to the main menu. Results which aren't saved will be immediately lost.

SNYPER Setup Menu

By selecting 'Setup' from the main menu, the following setup changes can be made (as shown below in figure 33). To select a sub menu use the UP/DOWN button until relevant menu is highlighted, then use the LEFT/RIGHT buttons to amend preference.

Figure 33. 'Setup' screen

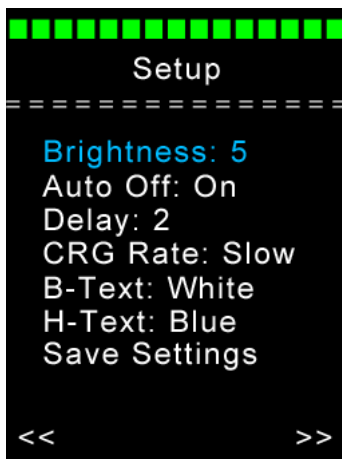

Brightness: 5

Brightness: SNYPER LCD brightness.
The screen brightness has 6 settings, 0 (lowest) - 5 (highest).

Auto Off: On

Auto Off: Automatic power off of the SNYPER.
The auto off has 2 settings, on or off.

Delay: 2

Delay: Time in minutes the SNYPER stays on after last button press.
The delay has 5 settings, 1 minute - 5 minutes.

CRG Rate: Slow

CRG Rate: Battery charging rate of the SNYPER.
The charging rate has 2 settings, slow or fast.

B-Text: White

B-Text: Colour of body text on the LCD screen.
The SNYPER has 13 body text colour settings.

H-Text: Blue

H-Text: Colour of highlighted text on the LCD screen.
The SNYPER has 13 highlighted text colour settings.

Save Settings

Save Settings: Saves setup menu changes.
Saves any changes made to the setup menu.

Saving Setup Preferences

Step 1. Once you have amended your setup preferences, you can save the new settings by selecting 'Save Settings' from the 'Setup' menu.*

Step 2. Once the 'Save Settings' option is highlighted, you will be prompted to select 'YES' to confirm the save, or 'NO' to cancel the save. Whilst the settings are being saved, a message will be displayed as shown below in **figure 34**.

Figure 34. Saving settings to the SNYPER



Once the settings have been stored, the SNYPER will return to the main menu.

*The SNYPER doesn't automatically save setup preferences, if you wish to save new setup follow steps 1 and 2 above. If you do not wish to save new setups, return to the main menu.

Software Options Menu

By selecting 'Options' from the main menu, the following options can be selected (as shown below in figure 35). To select a sub menu use the UP/DOWN button until relevant menu is highlighted, then use the LEFT/RIGHT buttons to amend preference.

Sub menus that are highlighted yellow are currently disabled and can't be changed.

Figure 35. 'Options' screen

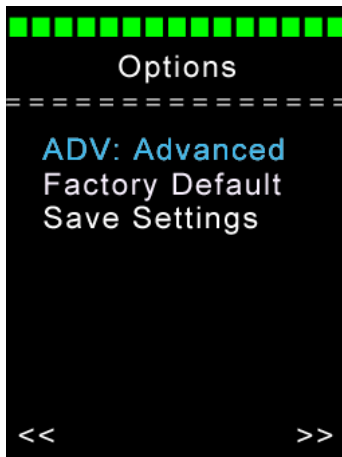

ADV: Advanced

ADV: The SNYPER mode of operation. The adv has 3 settings, standard, advanced or engineer mode.*

Factory Default

Factory Default: Defaults **all** options to factory state.

Save Settings

Save Settings: Saves option menu changes. Saves any changes made to the options menu.

*See section 'ADV Option' over page for more information about SNYPER modes of operation.

ADV Option

The ADV option determines the operation mode of the SNYPER when performing a survey. There are 3 options: Standard, Advanced or Engineer - each will display a different range of results once a survey has been performed. The results displayed will vary depending on whether the SNYPER is a 2G or 3G version, see **table 4 - 6** below for more information.

Standard Mode - Standard mode receives and displays a basic range of results and is the factory default operation mode of the SNYPER. When performing a survey in Standard mode the following results will be displayed:

Table 4. Standard mode

Operating Band	SNYPER-2G	SNYPER-3G	
	GSM	GSM	UMTS
Index - Base station number assigned by the SNYPER	✓	✓	✓
Network - Name of the network provider	✓	✓	✓
MCC - Mobile Country Code being received	✓	✓	✓
MNC - Mobile Network Code being received	✓	✓	✓
dBm - Signal strength being received (Signal strength ranges from -51 to -115dBm, the lower the number the higher the signal strength.)	✓	✓	✓
RSSI - Received Signal Strength Indicator (Values range from 0 - 31, the higher the number the higher the signal strength.)	✓	✓	✓
Signal - Percentage signal received (Values range from 0% - 100%, the higher the number the higher the signal strength.)	✓	✓	✓
Band - Frequency band being received	✓	✓	✓
BER – Bit error rate in %	✓		

Advanced Mode - Advanced mode receives and displays a more advanced range of results in addition to the results displayed in Standard mode. When performing a survey in Advanced mode the following results will be displayed:

Table 5. Advanced mode

Operating Band	SNYPER-2G	SNYPER-3G	
	GSM	GSM	UMTS
CellID - Unique ID of the network cell being received	✓	✓	✓
ARFCN - Absolute Radio Frequency Channel Number being received	✓	✓	
UARFCN - UTRA Absolute Radio Frequency Channel Number being received			✓
BSIC - Base Station Identity Code being received	✓	✓	
SCR - Basestation scrambling code			✓
LAC - Location Area Code being received	✓	✓	✓

Engineer Mode - Engineer mode receives and displays the most advanced range of results in addition to the results displayed in Advanced mode. When performing a survey in Engineer mode the following results will be displayed:

Table 6. Engineer mode

Operating Band	SNYPER-2G	SNYPER-3G	
	GSM	GSM	UMTS
DL MHz - Downlink frequency channel in MHz	✓	✓	
UL MHz - Uplink frequency channel in MHz	✓	✓	

Restoring to Factory Default

Step 1. To perform a factory reset on the SNYPER, select 'Factory Default' from the 'Options' menu.

Step 2. Once the 'Factory Default' option is highlighted, you will be prompted to select 'SET' to confirm the reset, to do this press the 'OK' button.

Figure 36. Saving factory default settings to the SNYPER



Selecting the factory default option will default **ALL** of the SNYPER values to their factory setting. Once the SNYPER has been restored, it will return to the 'Main Menu'.

Saving Option Preferences

Step 1. Once you have amended the SNYPER options, you can save the new settings by selecting 'Save Settings' from the 'Options' menu.*

Step 2. Once the 'Save Settings' option is highlighted, you will be prompted to select 'YES' to confirm the save, or 'NO' to cancel the save. Whilst the settings are being saved, a message will be displayed as shown below in **figure 37**.

Figure 37. Saving settings to the SNYPER



Once the settings have been stored, the SNYPER will return to the main menu.

*The SNYPER doesn't automatically save changed options, if you wish to save new setup follow steps 1 and 2 above. If you do not wish to save new setups, return to the main menu.

About Menu

By selecting 'About' from the main menu, information about the SNYPER will be displayed (as shown below in figure 38).

Figure 38. 'About' screen

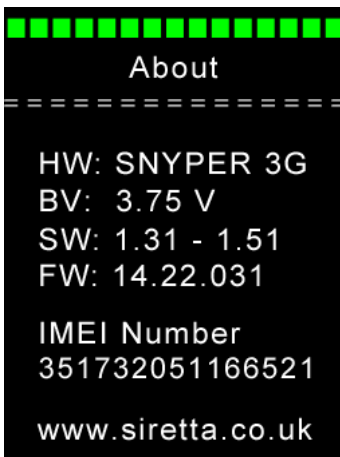

HW: SNYPER 3G

HW: SNYPER hardware version

The hardware version determines whether the SNYPER works on GSM or UMTS networks.

BV: 3.75 V

BV: SNYPER battery voltage

The battery voltage (measured in Volts) the SNYPER is running on.

SW: 1.31 - 1.51

SW: SNYPER software version

The current application and loader software versions running on the SNYPER.

FW: 14.22.031

FW: SNYPER firmware version

The current modem firmware software version running on the SNYPER.

IMEI Number

351732051166521

IMEI Number: SNYPER (IMEI) number

The unique IMEI number of the SNYPER.

SNYPER Antenna

Using Other Antennas with the SNYPER

The SNYPER can be easily used to evaluate other antennas. The evaluation of other antennas is carried out to find the strongest signal available for a particular application. The antenna with the strongest results will be used.

Evaluating other antennas:

1. Unscrew supplied antenna from the SNYPER.
2. Connect the antenna to be evaluated.
(The new antenna must have an SMA male connector to connect to the SNYPER. If the chosen antenna has a different connector, then an RF adaptor will need to be used (these are available from Siretta*).
3. With the antenna connected to the SNYPER, a survey can be performed. If evaluating multiple antennas, operator details and signal levels can be noted and compared to find the best antenna.

The SNYPER can also be easily used to evaluate directional antennas (such as Yagi). The evaluation of directional antennas is carried out to find which position of the antenna receives the strongest signal. The position with the strongest results will be used.

Evaluating directional antennas (such as Yagi):

1. Follow steps 1 and 2 as above
2. Adjust antenna's directional position towards the desired operators mast. Note the signal levels received.
3. Repeat step 3, this process should be continued until the antenna direction with the strongest signal is found.

*Please contact your Siretta representative or visit www.siretta.co.uk

Safety and Product Care

General Precautions

- » Do not exceed the environmental and electrical limits as specified.
- » Avoid exposing the SNYPER to lit cigarettes, naked flames or to extreme hot or cold temperatures.
- » Never try to dismantle the SNYPER. There are no components on the SNYPER that can be serviced by the user. If you attempt to dismantle the SNYPER, you will invalidate the warranty.
- » Do not connect any incompatible component or product to the SNYPER signal analysers.

Exposure to RF Energy

There has been some public concern about possible health effects of using GSM equipment in close proximity to a person or body. Although research on health effects from RF energy has focused for many years on the current RF technology, research has begun on new radio technologies, such as GSM and UMTS. After existing research had been reviewed, and after compliance to all applicable safety standards has been tested, it has been concluded that the SNYPER analyser is fit for use.

If you are concerned about exposure to RF energy, there are a number of things you can do to minimize exposure. Obviously, limiting the duration of time near a device will reduce your exposure to RF energy. In addition, you can reduce RF exposure by operating your SNYPER efficiently by adhering to the following guidelines:

Electronic devices: Most electronic equipment, for example in hospitals and motor vehicles is shielded from RF energy. However, RF energy may affect some malfunctioning or improperly shielded electronic equipment.

Vehicle electronic equipment: Check your vehicle manufacturer's representative to determine if any on board electronic equipment is adequately shielded from external RF energy.

Medical electronic equipment: Consult the manufacturer of any personal medical devices (such as pacemakers, hearing aids, etc.) to determine if they are adequately shielded from external RF energy.

Turn your device OFF in health care facilities when any regulations posted in the area instruct you to do so. Hospitals or health care facilities may be using RF monitoring equipment.

Aircraft: Turn your device OFF before boarding any aircraft. To prevent possible interference with aircraft systems, Federal Aviation Administration (FAA) regulations require you to have permission from a crew member to use your terminal equipment whilst the plane is on the ground. To prevent interference with cellular systems, local RF regulations prohibit using your modem whilst in the air.

Blasting areas: To avoid interfering with blasting operations, turn your device OFF when in a “blasting area” or in areas posted: “turn off two-way radio“. Construction crew often uses remote control RF devices to set off explosives.

Potentially explosive atmospheres: Turn your device OFF when in any area with a potentially explosive atmosphere. It is rare, but your SNYPER or their accessories could generate sparks. Sparks in such areas could cause an explosion or fire resulting in bodily injury or even death.

Areas with a potentially explosive atmosphere are often, but not always, clearly marked. They include fuelling areas such as petrol stations, below deck on boats, fuel or chemical transfer or storage facilities and areas where the air contains chemicals or particles, such as grain, dust or metal powders. Do not transport or store flammable gas, liquid or explosives, in the compartment of your vehicle, which contains your SNYPER or accessories. Before using your terminal in a vehicle powered by liquefied petroleum gas (such as propane or butane) ensure that the vehicle complies with the relevant fire and safety regulations of the country in which the vehicle is to be used.

Safety Recommendations

PLEASE READ CAREFULLY

Be sure the use of this product is allowed in the country intended and the environment required. The use of this product may be dangerous and has to be used with caution in the following areas:

- » Where it can interfere with other electronic devices in environments such as hospitals, airports, aircrafts, etc
- » Where there is risk of explosion such as gasoline stations, oil refineries, gas works etc

It is responsibility of the user to enforce the country regulation and the specific environment regulation.

Do not disassemble the product, any mark of tampering will compromise the warranty.

Should there be any doubt, please refer to the technical documentation and the regulations in force.

Conformity Assessment

The SNYPER range of signal analysers has been designed to conform to the R&TTE Directive for use as a stand-alone product. If the analyser is used in compliance with the user guide instructions then no further evaluation is required under Article 3.2 of the R&TTE Directive and no further involvement of an R&TTE Directive Notified Body is required for the final application.

The SNYPER range of signal analysers conform to the following European Union Directives:

- » R&TTE Directive 1999/5/EC (Radio Equipment & Telecommunications Terminal Equipment)
- » LVD (Low Voltage Directive) 73/23/EEC and product safety
- » Directive 89/336/EEC for conformity for EMC

In order to satisfy the essential requisite of the R&TTE 99/5/EC directive, the SNYPER range of signal analysers are compliant with the following standards:

- » GSM (Radio Spectrum). Standard: EN 301 511 and 3GPP 51.010-1
- » EMC (Electromagnetic Compatibility). Standards: EN 301 489-1 and EN 301 489-7
- » Include stand-alone spurious emissions to Clause 8.2 of EN 301 489-1.
- » LVD (Low Voltage Directive) Standards: EN 60 950

Disclaimer

The information contained in this document is proprietary to Siretta Ltd. Siretta has made every effort to ensure that the accuracy of the information contained within this document is accurate. Siretta does not make any warranty as to the information contained within this document and does not accept any liability for any injury, loss or damage of any kind incurred by the use of this information.

Siretta does not take responsibility for any application developed using the device characterized in this document and notes that any application of this device must comply with the safety standards of the applicable country and comply with the relevant wiring rules. Siretta reserves the right to make modifications, additions and deletions to this document due to typographical errors, inaccurate information, or improvements to equipment at any time and without notice. Such changes will be incorporated into new editions of this document.

All rights reserved.

© 2014 Siretta Ltd

Definitions

Term	Definition
2G	2nd Generation Mobile Telecommunications
3G	3rd Generation Mobile Telecommunications
ARFCN	Absolute Radio Frequency Channel Number
BSIC	Base Station Identity Code
CellID	Cell Identity
dBm	Decibels per meter
DL	Downlink
GPRS	General Packet Radio Service
GSM	Global System for Mobile Communications
IMEI	International Mobile Equipment Identity
LAC	Location Area Code
LCD	Liquid Crystal Display
LED	Light Emitting Diode
MCC	Mobile Country Code
MNC	Mobile Network Code
RSSI	Received Signal Strength Indicator
SCR	Basestation Scrambling Code
SIM	Subscriber Identity Module
SMA	Sub Miniature version A
UARFCN	UTRA Absolute Radio Frequency Channel Number
UL	Uplink
UMTS	Universal Mobile Telecommunications System (Same as 3G)
USB	Universal Serial Bus

Become A Distributor

Siretta is currently growing its worldwide distributor and reseller base. Distributors can benefit from an excellent product range, marketing and technical support, along with the widest range of Antennas, Connectors, Cable Assemblies and Wireless Terminals.



sales +44 (0)118 976 9014
fax +44 (0)118 976 9020
accounts +44 (0)118 976 9069
email sales@siretta.co.uk

www.siretta.co.uk

Siretta Ltd
Basingstoke Road
Spencers Wood
Reading
Berkshire
RG7 1PW
United Kingdom

Company No. 08405712
VAT Registration No. GB163 04 0349

A member of the Olanca Group Ltd



Rev 1.5 - August 2014

X-ON Electronics

Largest Supplier of Electrical and Electronic Components

Click to view similar products for [SIRETTA](#) manufacturer:

Other Similar products are found below :

[ALPHA4A/5M/SMAM/S/S/26](#) [DELTA5A/X/SMAM/S/S/17](#) [OSCAR17/X/TNC/S/S/19](#) [DELTA5A/X/BNCM/S/S/17](#) [SNYPER-LTE-SPECTRUM](#) [ASMA2000F058L13](#) [ASMA2000C058L13](#) [TANGO14/5M/LL/SMAM/S/S/24](#) [TANGO1/1M/FMEF/S/S/4](#) [ASME500F058L13](#) [TANGO3/0.5M/SMAM/S/S/31](#) [TANGO40/X/NTYPEF/S/S/32](#) [QUARTZ-W22-LTE\(EU\)+ACC](#) [ASMA500B174L13](#) [31557](#) [ECHO40/0.1M/UFL/S/S/32](#) [MIKE1A/5M/FMEF/S/S/20](#) [QUARTZ-W22-UMTS\(EU\)+ACC](#) [TANGO11A/2.5M/SMAM/S/S/19](#) [ASMA500F058L13](#) [ZETA-N-UMTS](#) [ECHO11/0.2M/IPEX/S/S/12](#) [ASMA300E174L13](#) [ASMA1000F058L13](#) [DELTA19/X/SMAM/S/S/35](#) [ASMA2000E058L13](#) [ASMZG300F058L13](#) [MIKE3A/5M/SMAM/S/S/17](#) [TANGO15/3M/SMAM/SMAM/S/S/24](#) [TANGO20/3M/SMAM/S/S/26](#) [ASMZG500A058L13](#) [ASMZG1500F058L13](#) [ALPHA1A/2.5M/SMAM/S/S/11](#) [OSCAR40/10M/LL/SMAM/S/S/33](#) [TANGO11A/5M/LL/SMAM/S/S/19](#) [TANGO29/1M/SMAM/RP/S/35](#) [ASME2000F058L13](#) [ASMK015X174S11](#) [LC300-N2-GPRS](#) [DELTA6A/X/SMAM/S/S/11](#) [MIKE1A/2.5M/FMEF/S/S/20](#) [ASMZG1000F058L13](#) [OSCAR41/X/NTYPEF/S/S/29](#) [TANGO22/3M/SMAM/SMAM/SMAM/26](#) [OSCAR420/0.4M/NTYPEF/S/S/19](#) [ASMK010X174S11](#) [ZETA-N2-GPRS](#) [ADAPT/SMAM/RP](#) [OSCAR18/X/NF/S/S/22](#) [TANGO14/3M/SMAM/S/S/24](#)