

No. HM-0279 (OM-7072944)		Date issued: May 31, 2010
Title of Document: HANDLING MANUAL	Revision No.	Date revised:
Title Subject: YPT-60N Hand-Operated Hydraulic Tool		Issued by: Osaka Engineering Center

C O N T E N T S

	Page
i. Preface	2
ii. Precautions for safety	2
1. Standard Accessories and Main Part Name	4
1-1 Tool main body	4
1-2 Die (1 set)	4
1-3 Portable case (1 pc.)	4
2. Crimping Operation	5
2-1 Reference table between die and wire	5
2-2 Mounting die	5
2-3 Wire insulation strip dimension (reference)	5
3. Maintenance Inspection	7
3-1 Maintenance	7
3-2 Daily inspection	7
3-3 Trouble in operation	8
Exploded View	9
Parts List	10
JST Sales Office	12



Prepared by: <i>T.Sawano</i>	Checked by: 	Reviewed by: <i>H.Inoue</i>	Approved by: <i>J.Onishi</i>
-------------------------------------	---------------------	------------------------------------	-------------------------------------

Title: HANDLING MANUAL YPT-60N Hand-Operated Hydraulic Tool	No. HM-0279 (OM-7072944)	Rev. No.
--	-----------------------------	----------

i. Preface

This handling manual describes handling method, basic crimping operation, handling precautions of YPT-60N hand-operated hydraulic tool.

It is for a person responsible and a supervisor at work place to operate correctly and safely. Before using this tool, be sure to read it through.

If points unclear or hard to understand arise, contact JST sales office.

A person responsible or a supervisor must understand sufficiently on operation method and safety operation, and then instruct them to operators.

In this manual, easy daily inspection and maintenance are shown, so please keep this manual handy with tool.

This tool is conformed to JIS (Japanese Industrial Standard), "Compression Tool for Wire Connectors of Interior Wiring".

ii. Precautions for safety

In this manual, warning relating to physical injury is captioned as

“ **WARNING,**”

and caution relating to breakage and trouble of machine or facility is captioned as

“ **CAUTION.**”



WARNING

- **Never handle this tool roughly.**

The weight is approx.3kg. If dropped on your body such as foot, you may be seriously injured more than expected. Handle it with care.

- **Do crimping operation with care.**

In crimping, the load required for handle part is maximum 235N.

Slippery handle grip part is very dangerous. Always keep the handle grip part dry out of oil or something slippery.

Cautiously watch out for crimping part, handle stopper part and fulcrum part not to put finger in.

Title: HANDLING MANUAL YPT-60N Hand-Operated Hydraulic Tool	No. HM-0279 (OM-7072944)	Rev. No.
--	-----------------------------	----------

**CAUTION**

- **Check die condition.**

- ① Before crimping operation, in order to avoid the die breakage and crimping defect, check that the crimping and bottom surfaces of the die and the die setting surface of the piston are free from any foreign substances such as dust, peeling of plating, scratches and deformation.
- ② Set die properly. The load applied to the die is heavy, so if improperly set, trouble or breakage may arise on the tool or the die.
- ③ Check the applicability between the die and the terminal. The combination of the die, terminal and wire must be proper. If improperly combined, crimping defect such as insufficient/undue crimping, the tool or die breakage or any other troubles may arise. Check the die, the terminal to be used and wire applicable size.

- **Never crimp without terminal.**

If the tool operation is necessary for the inspection or something, do it under the condition that the die is removed or head is opened.

- **Insert thrust pin fully.**

If the insertion of the thrust pin is short, in crimping, the pin, head or any other parts are likely to be broken; otherwise insufficient crimping may be caused, which leads to electrical discontinuity.

- **Do not use the tool for other than crimping terminal.**

This tool is for crimping terminal specified in JIS C 9711, so neither use it for other purposes nor modify it.

- **Do not combine other unspecified products.**

Non-genuine products (die, parts, etc.) are not compatible to this tool, so do not allow to use other than JST specified ones.

- **If you feel abnormality during crimping, stop the operation immediately and inspect the tool.**

If you cannot find the abnormal cause through the inspection, do not restart and disassemble the tool but contact JST sales office.

- **Periodically inspection is necessary.**

In order to keep the good quality and good crimping performance, periodical inspection is necessary for the tool. Contact JST sales office for the periodical inspection

Title: HANDLING MANUAL YPT-60N Hand-Operated Hydraulic Tool	No. HM-0279 (OM-7072944)	Rev. No.
--	-----------------------------	----------

1. Standard Accessories and Main Part Name

1-1 Tool main body

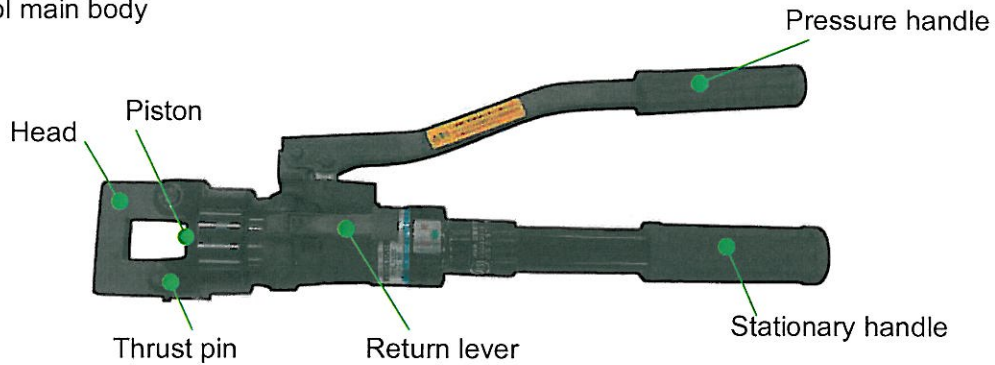

Tool model No.	YPT-60N
Applicable wire size	8 to 60 mm ²
Nominal output	69 kN (7 ton)
Stroke	10 mm
Tank capacity	Approx. 83 cm ³
Dimension	Thickness: 75 mm Width: 130 mm (Maximum height at handle part) Total length: 435 mm
Weight	3.0 kg

1-2 Die (1 set)



Female die: 5 types (1 each)



Male die: 3 types (1 each)

Nominal	Model No.		Applicable terminal
	Female die	Male die	
8	TD-121	TD-111	Non-insulated solderless terminal Non-insulated solderless splice • Parallel type • Butt type
14	TD-122		
22	TD-123	TD-112	
38	TD-124		
60	TD-125		

1-3 Portable case (1 pc.)



Title: HANDLING MANUAL YPT-60N Hand-Operated Hydraulic Tool	No. HM-0279 (OM-7072944)	Rev. No.
--	-----------------------------	----------

2. Crimping Operation

 **WARNING**

- Check that handle grip is free from oil or something slippery so as not to slip hand in operation.

2-1 Reference table between die and wire

Applicable wire for connector nominal	Female die	Male die	Stranded fire for non-insulated crimp-type terminals for copper conductor in JIS C 2805	Stranded wire for non-insulated crimp-type sleeve for copper conductor in JIS C 2806	
				Butt type (B-type) mm ²	Parallel type (P-type) mm ²
8	TD-121	TD-111	8	8 & 8	3.5 & 3.5
14	TD-122		14	14 & 14	5.5 & 5.5, 8 & 8
22	TD-123	TD-112	22	22 & 22	8 & 14
38	TD-124		38	38 & 38	14 & 14
60	TD-125	TD-113	60	60 & 60	22 & 22

2-2 Mounting die

Check the die is fitted to wire.

- Female die**
There are balls inside the head.
Mate dies each other so that the concave part fits to the balls.

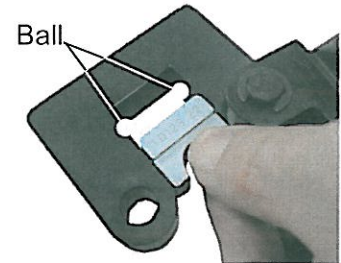

- Male die**
Insert the die shaft into piston hole and mate it with the concave part.
If the mating is insufficient, the die may be broken.

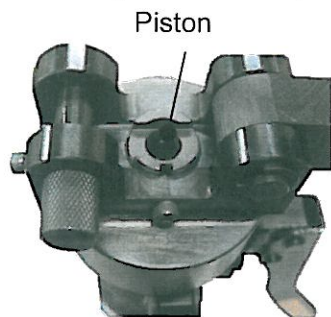

2-3 Wire insulation strip dimension (reference)

Nominal of ring tongue terminal (R-type)	L1	B	L2	Wire strip length (L=L2+B+L1)
8	0~2	8.5 ^(Note1)	1~2	9.5~12.5
14	0~2	10.5 ^(Note2)	1~2	11.5~14.5
22	0~2	12	1~2	13~16
38	0~2	14	1~2	15~18
60	0~1	18	2~3	20~22

Note₁: Dimension-B of "8-NK4/5" is 6.2.

Note₂: Dimension-B of "14-NK5" is 9.2.

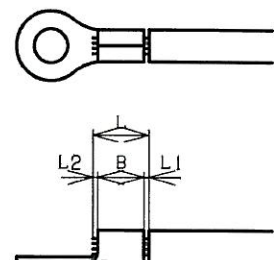

Title: HANDLING MANUAL YPT-60N Hand-Operated Hydraulic Tool	No. HM-0279 (OM-7072944)	Rev. No.
--	-----------------------------	----------

 **CAUTION**

- Female die is just held with balls. Rough handling displaces the holding position, which may cause crimping defect or die breakage. Before crimping operation, be sure to check that the female die is fitted to the proper position.

 **WARNING**

- In crimping, do not turn the head to someone. Should the broken parts fly off, someone may be injured.

- Check that the die is set properly. Insert thrust pin fully.
- Turn brazing part of terminal to male die and set the terminal to the position where the male die pushes the almost center of the tube.
- Push down the pressure handle to go up the piston and stop the handle operation at the place where the male die softly holds the terminal.
- Check the crimping position.
- Insert the stripped wire into die.
- Repeat the pressure handle operation until the handle has no load. When the crimping completes, check that the red line of the piston appears.

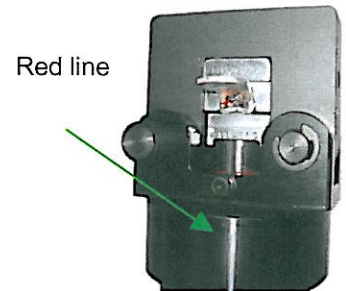
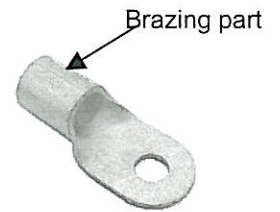

Remark: At first, operate handle largely and do it small just before crimping, you can operate relatively easy.

- Push down the return lever to come down the piston.
- As soon as the piston comes down, take out the crimped terminal.
- Check the appearance of the crimped terminal.

- Almost center of terminal barrel part is crimped.
- Wire conductor is visible between crimped terminal and its insulation.
- The end of wire conductor come out to the terminal tongue part.
- Crimping mark is clearly visible.
- No wire conductors come out without crimping.
- No abnormal deformation and scratches on the total of the crimped terminal.

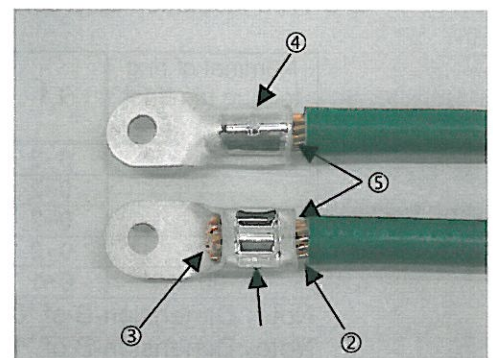

Title: HANDLING MANUAL YPT-60N Hand-Operated Hydraulic Tool	No. HM-0279 (OM-7072944)	Rev. No.
--	-----------------------------	----------

3. Maintenance Inspection

3-1 Maintenance

- ① After using, wipe softly any other parts surfaces by oil cloth except for the handle grip, and store the tool.
- ② Take care of die surface and its mounting part especially so as to keep foreign substances-free.
- ③ If you need to refill parts due to breakage and missing of pin, retaining ring, spring, etc., do not add non-genuine one for temporarily measures but contact JST sales office.

3-2 Daily inspection

At the operation startup, do daily inspection for items below.
It is preferable to inspect the die clearance dimension about once a month.

Item	Method	Criterion
Appearance	1. Check scratch, crack, deformation, rust, etc. on each part. 2. Check breakage or missing of each part such as pin retaining ring and spring	No harmful flaws on each part such as scratch, crack, deformation and breakage or no missing of the assembly parts
Die	1. Check that the piston and the head die are properly fitted. 2. Check that die each part is free from any damage such as scratch, deformation, peeling of plating. 3. Check the clearance dimension between male and female dies by a limit pin gauge under the condition that each die is fitted to the tool and touched softly.	1. Dies shall be smoothly fitted to the appropriate positions without large looseness and firmly held with ball not to drop off. 2. After crimping, the terminal shall be free from a detrimental damage, being clung with the die and deformation. 3. The limit pin gage can be inserted to GO side with even a little force, while it cannot be done to NOGO side.
Actuation	1. Check that the thrust pin can be inserted and extracted out and the head opens and closes smoothly. 2. Check that the piston moves up and down smoothly. 3. Check that oil does not leak at each part.	1. The insertion/extraction operation of the thrust pin shall be smooth without being caught. 2. The up/down move of the piston shall be smooth and the descending speed of the piston is not outstanding low. 3. Under the pressure condition, oil does not spread or leak at each part.
Full crimping	After normal crimping operation, check the top dead position of the die.	After crimping, the male and female dies touch closely.

Title: HANDLING MANUAL YPT-60N Hand-Operated Hydraulic Tool	No. HM-0279 (OM-7072944)	Rev. No.
--	-----------------------------	----------

3-3 Trouble in operation

When any trouble happens, inadequate handling or following factors are considered.
If other abnormalities than the list below happen, contact JST sales office.

Trouble	Cause	Trouble-shooting
Even if pressure control valve actuates in crimping, the piston does not go up to the top dead center (red line is invisible.)	Insufficient pressure	Contact JST sale office.
Even if pressure handle is operated, <ul style="list-style-type: none">• Piston does not go up.• Piston stops halfway.• After the piston goes up, the handle has no pressure.	A: Insufficient oil B: Malfunction of valve and its related	Contact JST sale office.
Even if the pressure handle is operated, <ul style="list-style-type: none">• The going-up speed of the piston is low.• Pressure handle has a play.	A: Air mixing in ram chamber B: Malfunction of valve and its related	Contact JST sale office.

Exploded view

MODEL YPT-60N

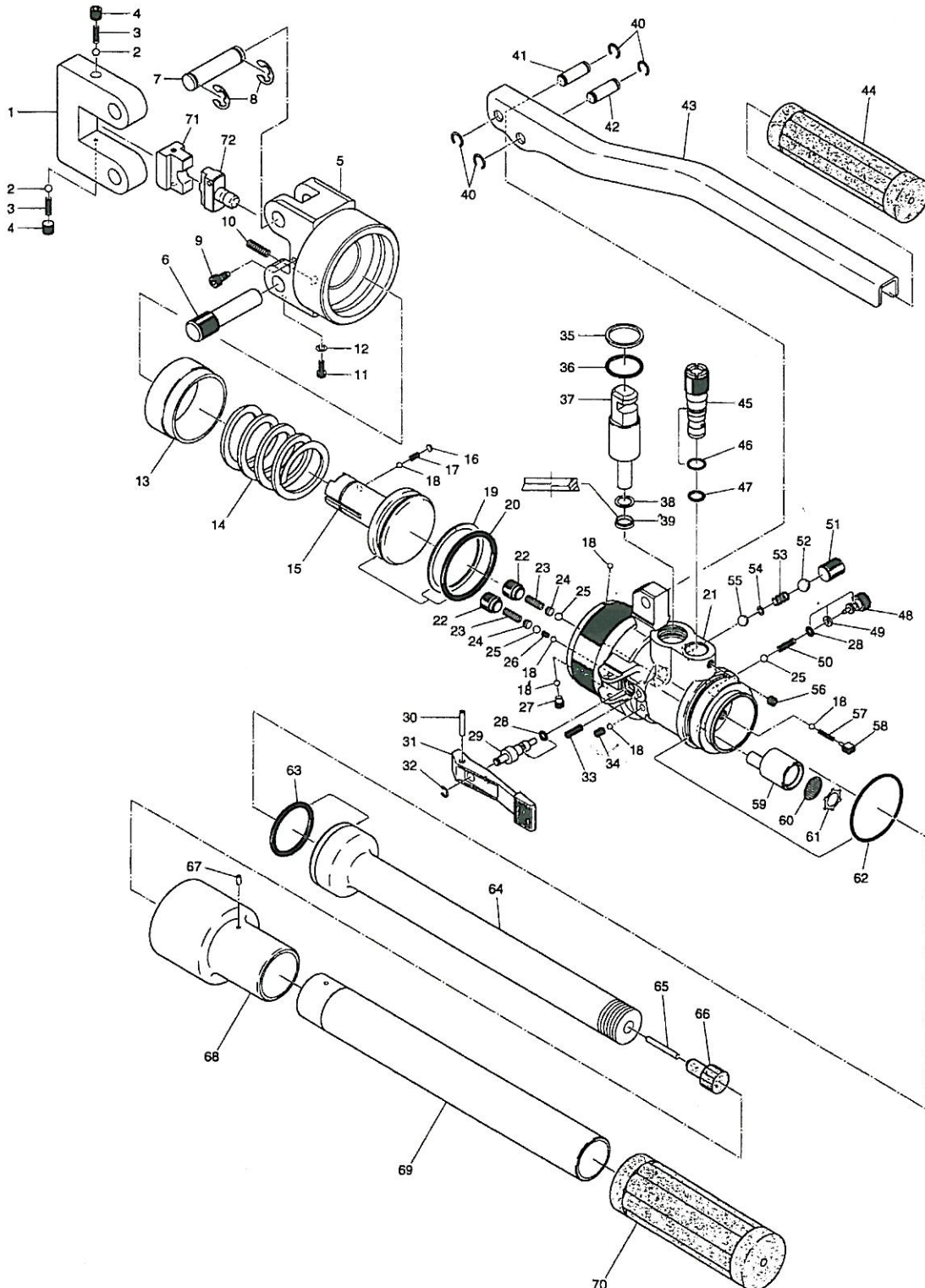

Title: HANDLING MANUAL YPT-60N Hand-Operated Hydraulic Tool	No. HM-0279 (OM-7072944)	Rev. No.
--	-----------------------------	----------

Parts List

No.	Drawing No.	Part Name	Q'ty	Remarks
1	112140491	Yoke	1	
2	112900580	Steel ball for ball bearing 5/32	2	
3	112140050	Spring (127)	2	
4	112902110	Hexagon socket set screw flat point M6 × 6	2	
5	112142040	Cylinder rod	1	
6	112140070	Slide pin	1	
7	112140080	Shaft (23)	1	
8	112140090	Retaining ring E-type E-74	2	
9	112140100	Key screw	1	
10	112140120	Spring (129)	1	
11	114901520	Hexagon head cap screw M3 × 8	1	
12	112902120	Spring washer size-2 3S	1	
13	112142060	Spacer	1	
14	119450151	Spring (439)	1	
15	112142070	Piston	1	
16	112901280	Push plate	1	
17	112902600	Spring (7)	1	
18	112900040	Steel ball for bearing 1/8	6	
19	113900750	Backup ring T2 P38	1	
20	112901970	O-ring I-A type P38	1	
21	112013050	Body	2	
22	112900180	Presser screw (1)	2	
23	112090901	Spring (227)	2	
24	112090911	Ball catch	2	
25	112900160	Steel ball for bearing 3/16	3	
26	112090600	Spring (164)	1	
27	119901060	Hexagon socket set screw dog point M5 × 6 Nylok	1	
28	112904210	Cool resistant o-ring P3	2	
29	114540110	Return shaft	1	
30	112904790	Spring pin 3 × 16 AW	1	
31	114500170	Return lever	1	
32	114900280	Retaining ring E-type E-3.2	1	
33	112360530	Spring (371)	1	
34	112160290	Hexagon socket set screw flat point M4 × 5	1	
35	112903650	X-ring I-A type P18	1	
36	112904240	Cool resistant o-ring P18	1	
37	112013060	Plunger	1	
38	112903030	Backup ring T2 P8	1	
39	112900150	PENTA-seal PS8	1	
40	111900320	Retaining ring CE-7	4	
41	112530340	Shaft (158)	1	
42	112530330	Shaft (157)	1	
43	112530320	Pressure handle	1	
44	112360341	Pressure handle grip	1	
45		Cartridge valve assembly	1 assy	
	112530100	Valve main body	1	
	112530110	Valve sheet	1	
	112530120	Valve stem	1	
	112530130	Spring (394)	1	
	112904210	Cool resistant O-ring P3	1	
	112903150	Hexagon socket set screw dog point M5 × 6 Nylok	1	
46	112903720	O-ring I-A type S9	1	
47	112530260	Cool resistant O-ring P7	1	
48	112530140	Plug	1	

Title: HANDLING MANUAL YPT-60N Hand-Operated Hydraulic Tool	No. HM-0279 (OM-7072944)	Rev. No.
--	-----------------------------	----------

No.	Drawing No.	Part Name	Q'ty	Remarks
49	112902840	Backup ring T2 P3	1	
50	112530150	Spring (395)	1	
51	112901920	Hexagon socket set screw flat point M10 × 12	1	
52	112901110	Steel ball for bearing 9/32	1	
53	114900250	Spring (76)	1	
54	114900290	Flat washer small round shape-3	1	
55	112900770	Steel ball for bearing 7/32	1	
56	112903280	Hexagon socket set screw with notched on the tip M5 × 5	1	
57	112530170	Spring (396)	1	
58	112530160	Pressure screw (20)	1	
59	112530200	Strainer	1	
60	112530210	Filter	1	
61	112900510	SI ring SI-15	1	
62	112530270	O-ring Type 1-A type P40	1	
63	112903630	O-ring Type 1-A type P28	1	
64	112530220	Oil tank (19)	1	
65	112904750	Magnet φ3 × 25	1	
66	112180640	Rubber plug	1	
67	112904530	Spring pin 2.5 × 5 AW	1	
68	112530290	Tank cover	1	
69	112530300	Handle	1	
70	112360391	Grip fitted to handle	1	
71		Female die		
	112140441	Female die-8	1	
	112140451	Female die-14	1	
	112140461	Female die-22	1	
	112140472	Female die-38	1	
	112140481	Female die-60	1	
72		Male die		
	112140413	Male die-8-14	1	
	112140423	Male die-22-38	1	
	112140433	Male die-60	1	

Title: HANDLING MANUAL YPT-60N Hand-Operated Hydraulic Tool	No. HM-0279 (OM-7072944)	Rev. No.
--	-----------------------------	----------

JST Sales Office

Country	Sales office
Japan	J. S. T. MFG. CO., LTD. 6-8, 2-Chome, Shigino-Nishi, Joto-Ku, Osaka, 536-0014 Japan. Phone: 81-6-6968-6855 Fax : 81-6-6964-2085 <G4>
Singapore	J. S. T. COMPONENTS (S) PTE., LTD. 601, Sims Drive #04-11/13, Pan-I Complex, Singapore 387382. Phone: 65-6743-0405 Fax : 65-6743-2775
CHINA	J.S.T. (H.K.) CO., LTD. Unit A, 15/F., C.D.W. Building, 382-392, Castle Peak Road, Tsuen Wan, N.T., Hong Kong, CHINA. Phone: 852-24137979 Fax: 852-24111193
U. S. A.	J. S. T. SALES AMERICA INC./J. S. T. CORPORATION 1957 South Lakeside Drive, Waukegan, IL. 60085, U. S. A. Phone: 1-847-473-1957 Fax : 1-847-473-0144 <G4>
	SAN DIEGO JST SALES INC. 891 Kuhn Drive Suite 216 Chula Vista, CA. 91914, U.S.A. Phone: 1-619-482-8447 Fax : 1-619-482-8501
U.K.	J. S. T. (U.K) LTD. Blyth Road Halesworth, Suffolk, IP19 8EW, U.K. Phone: 44-1986-874131 Fax: 44-1986-874276

X-ON Electronics

Largest Supplier of Electrical and Electronic Components

Click to view similar products for JST manufacturer:

Other Similar products are found below :

[B02B-WPJSS-1 \(LF\)\(SN\)](#) [SGVHSF-002T-02](#) [IDH-KR-12](#) [10HR-4K](#) [WC-610M](#) [FNGS12-6](#) [TWE0.5-8](#) [YC-110R](#) [FVGS4-1 \(LF\)](#) [WC-800](#)
[WC-PUD2](#) [WC-SFH2](#) [S12B-J21DK-GGXR\(LF\)\(AU\)](#) [MKDP71002](#) [PSIP-06V-LE](#) [WC-SH2832](#) [WC-700M](#) [WC-121](#) [B3B-PH-SM4-](#)
[TB\(LF\)\(SN\)](#) [FVDDF5.5-375A \(LF\)](#) [FVWS2-M4 \(LF\)](#) [FVGS10-6 \(LF\)](#) [YHT-2622](#) [YC-670R](#) [YRS-243](#) [YRS-1090](#) [VLJ-20](#) [WC-0510DIN](#)
[WC-930](#) [WC-GVH2630](#) [S7B-ZR-3.4-\(LF\)\(SN\)](#) [S04B-XASS-1N-BN-\(LF\)\(SN\)](#) [YRS-852](#) [WC-691](#) [WC-1090](#) [IDB-12](#) [GTR1.5-8](#) [YRS-241](#)
[XAP-04V-1](#) [YRS-692](#) [YRS-480](#) [YRS-1091](#) [WC-JWPF](#) [S06B-ZESK-2D\(T\)\(LF\)\(SN\)](#) [WC1091](#) [WC-260P](#) [WC-530](#) [A03WS-MWT-N](#) [IDH-](#)
[NR-12](#) [LEBRP-01V-S](#)