

MEMS Ultra-Low Power Oscillator, 32.768 kHz Quartz XTAL Replacement

IM890 Series

Features:

- MEMS Technology
- Small SMD package: 2.0 x 1.2 mm (2012)
- Fixed 32.768 kHz output frequency
- NanoDrive™ programmable output swing for lowest power
- Pb-free, RoHS and REACH compliant

Typical Applications:

- Mobile Phones
- Tablets
- Health and Wellness Monitors
- Wireless Keypads
- Ultra-Small Notebook PC

Electronic Specifications:

Fixed Output Frequency	32.768 kHz	
Frequency Tolerance^[1]	±20 ppm max	T _A = +25°C, Post Reflow, Vdd: 1.5V – 3.63V
Frequency Stability^[2]	±75 ppm max	T _A = -10°C to +70°C Vdd: +1.50V to +3.63V
	±100 ppm max	T _A = -40°C to +85°C, Vdd: +1.50V to +3.63V
	±250 ppm max	T _A = -10°C to +70°C, Vdd: +1.20V to +1.50V
Aging +25°C ±2°C	±1 ppm max	1 st Year
Operational Supply Voltage	+1.20V min, +3.63 V max +1.50V min, +3.63 V max	T _A = -10°C to +70°C T _A = -40°C to +85°C
Core Operating Current^[3]	0.90 µA typ. 1.30 µA max 1.40 µA max	T _A = +25°C, Vdd: +1.80V No load T _A = -10°C to +70°C, Vdd max, +3.63V No load T _A = -40°C to +85°C, Vdd max, +3.63V No load
Output Stage Operating Current^[3]	0.065 µA/Vpp typ. 0.125 µA/Vpp max	T _A = -40°C to +85°C, Vdd: 1.5V – 3.63V. No load
Power-Supply Ramp	100 mSec max	T _A = -40°C to +85°C, 0 to 90% Vdd
Start-up Time at Power-up^[4]	180 mSec typ., 300 ms max 450 mSec max	T _A = -40°C ≤ T _A ≤ +50°C, valid output T _A = +50°C < T _A ≤ +85°C, valid output

Notes:

1. Measured peak-to-peak. Tested with Agilent 53132A frequency counter. Due to the low operating frequency, the gate time must be ≥100 ms to ensure an accurate frequency measurement.
2. Stability is specified for two operating voltage ranges. Stability progressively degrades with supply voltage below 1.5V. Measured peak-to-peak. Inclusive of Initial Tolerance at 25°C, and variations over operating temperature, rated power supply voltage and load.
3. Core operating current does not include output driver operating current or load current. To derive total operating current (no load), add core operating current + (0.065 µA/V) * (peak-to-peak output Voltage swing).
4. Measured from the time Vdd reaches 1.5V.

LVC MOS Output Option, T_A = -40°C to +85°C, typical values are at T_A = +25°C

Output Rise / Fall Time	100 nSec typ. 200 nSec max 50 nSec max	10-90% (Vdd), 15 pF load, Vdd = 1.5V to 3.63V 10-90% (Vdd), 5 pF load, Vdd ≥ 1.62V
Symmetry	48/52% min/max	
Logic “1”	90% min	Vdd: 1.5V – 3.63V. IOH = -10 µA, 15 pF
Logic ‘0’	10% max	Vdd: 1.5V – 3.63V. IOH = -10 µA, 15 pF

NanoDrive™ Programmable, Reduced Swing Output

Output Rise / Fall Time	200 nSec max	30-70% (VOL/VOH), 10 pF Load
Symmetry	48/52% min/max	
AC-coupled Programmable Output Swing	0.20 V to 0.80 V typ.	Vdd: 1.5V – 3.63V, 10 pF Load, IOH / IOL = ±0.2 µA. IM890 does not internally AC-couple. This output description is intended for a receiver that is AC-coupled. See Table 2 for acceptable NanoDrive swing options.
DC-Biased Programmable Output Voltage High Range	0.60 V to 1.225 V typ.	Vdd: 1.5V – 3.63V. IOH = -0.2 µA, 10 pF Load. See Table 1 for acceptable VOH/VOL setting levels
DC-Biased Programmable Output Voltage High Range	0.35 V to 0.80 V typ.	Vdd: 1.5V – 3.63V. IOL = 0.2 µA, 10 pF Load. See Table 1 for acceptable VOH/VOL setting levels.
Programmable Output Voltage Swing Tolerance	±0.055 V max	T _A = -40°C to +85°C, Vdd = 1.5V to 3.63V.
Period Jitter	35 nSec _{RMS} typ.	Cycles = 10,000, T _A = 25°C, Vdd = 1.5V – 3.63V

Ordering Information:

Part number Guide					
Package	Temp Range/ Freq Stability In ppm		Coupled	DC- coupled Output V_{oh} Table 4	DC- coupled Output V_{ol} Or AC Swing Table 3
IM890	C	± 75 (-10°C to +70°C)	A = AC Coupled	6 = 600 mV	1 = 200 mV (AC-coupled only)
	I	± 100 (-40°C to +85°C)	D = DC Coupled	7 = 700 mV 8 = 800 mV 9 = 900 mV 0 = 1.00 V 1 = 1.10 V 2 = 1.225 V A = AC- coupled C = rail-to rail LVCMOS	2 = 250 mV (AC-coupled only) 3 = 350 mV 4 = 400 mV 5 = 500 mV 6 = 600 mV 7 = 700 mV 8 = 800 mV C = rail-to rail LVCMOS

Note:

- 1) Industrial temp & corresponding 100 ppm frequency stability. Note, 100 ppm is only available for the industrial temp range, and 75 ppm is only available for the commercial temp range.

Example 1:

Park Number: IM890-CDCC-32.768		
Package	IM890	ILSI Part Number
Temp Range/ Freq Stability in ppm	C	Temperature Range = -10°C to +70°C Frequency Stability = ± 75 ppm
Coupled	D	DC Coupled
DC-coupled Output (V_{oh})	C	rail-to rail LVCMOS
DC-coupled Output (V_{oh}) or AC Swing	C	rail-to rail LVCMOS
32.768k	Frequency Output	

Example 2:

Park Number: IM890-IDCC-32.768		
Package	IM890	ILSI Part Number
Temp Range/ Freq Stability in ppm	I	Temperature Range = -40°C to +85°C Frequency Stability = ± 100 ppm
Coupled	D	DC Coupled
DC-coupled Output (V_{oh})	C	rail-to rail LVCMOS
DC-coupled Output (V_{oh}) or AC Swing	C	rail-to rail LVCMOS
32.768k	Frequency Output	

Notes:

- For XTAL replacement applications that will keep the chipset oscillator enabled, configure the NanoDrive™ output for a swing similar to the XTAL, approximately 250mV
- Please consult with sales department for any other parameters or options.
- Oscillator specification subject to change without notice.

Absolute Maximum Limits		
Parameter	Test Condition	Value
Continuous Power Supply Voltage Range (Vdd)		-0.5V to +3.63 V
Short Duration Maximum Power Supply Voltage (Vdd)	≤30 minutes, over -40°C to +85°C	+4.0V
Continuous Maximum Operating Temperature Range	Vdd = 1.5V - 3.63V	105°C
Short Duration Maximum Operating Temperature Range	Vdd = 1.5V - 3.63V, ≤30 mins	125°C
Human Body Model ESD Protection	HBM, JESD22-A114	3000 V
Charge-Device Model (CDM) ESD Protection	JESD220C101	750 V
Machine Model (MM) ESD Protection	T _A = 25°C	300V
Latch-up Tolerance	JESD78 Compliant	
Mechanical Shock Resistance	Mil 883, Method 2002	10,000 g
Mechanical Vibration Resistance	Mil 883, Method 2007	70 g
2012 SMD Junction Temperature		150°C
Storage Temperature		-65°C to +150°C

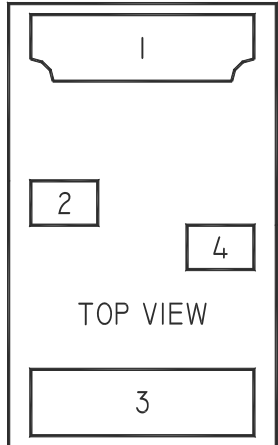
Pin Configuration				
Pin	Symbol	I/O	Functionality	SMD Package
1	N/C	No Connect	No Connect. Will not respond to any input signal. When interfacing to an MCU's XTAL input pins, this pin is typically connected to the receiving IC's X Out pin. In this case, the IM890 will not be affected by the signal on this pin. If not interfacing to an XTAL oscillator, leave pin 1 floating (no connect).	 <p>TOP VIEW</p>
2	GND	Power Supply Ground	Connect to ground. All GND pins must be connected to power supply ground.	
3	CLK Out	Output	Oscillator clock output. When interfacing to an MCU's XTAL, the CLK Out is typically connected to the receiving IC's X IN pin. The IM890 oscillator output includes an internal driver. As a result, the output swing and operation is not dependent on capacitive loading. This makes the output much more flexible, layout independent, and robust under changing environmental and manufacturing conditions.	
4	Vdd	Power Supply	Connect to power supply $1.5V \leq Vdd \leq 3.63V$ for operation over -40°C to +85°C temperature range. Under normal operating conditions, Vdd does not require external bypass/decoupling capacitor(s). Internal power supply filtering will reject more than ±150 mVpp with frequency components through 10 MHz.	

System Block Diagram

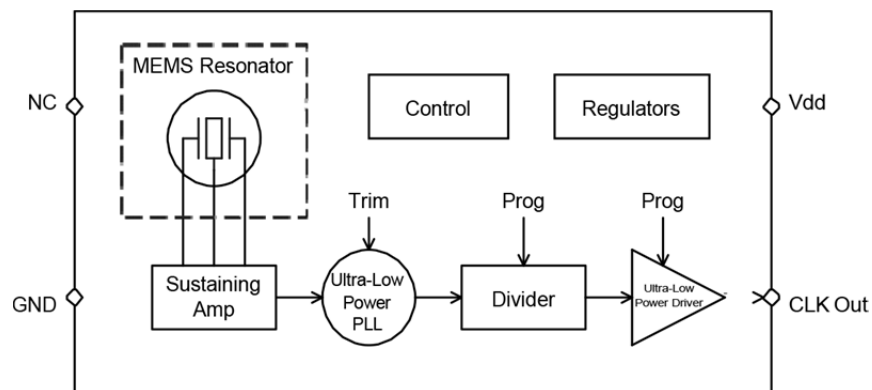

Figure 1.

Description

The 1.2V to 3.63V operating supply voltage range makes it an ideal solution for mobile applications that incorporate a low-voltage, battery-back-up source such as a coin-cell or super-cap.

XTAL Footprint Compatibility (SMD Package)

The IM890 is a replacement to the 32 kHz XTAL in the 2.0 x 1.2 mm (2012) package. Unlike XTAL resonators, The ILSI silicon MEMS oscillators require a power supply (Vdd) and ground (GND) pin. Vdd and GND pins are conveniently placed between the two large XTAL pins. When using the ILSI Solder Pad Layout (SPL), the IM890 footprint is compatible with existing 32 kHz XTALs in the 2012 SMD package. Figure 2 shows the comparison between the quartz XTAL footprint and the ILSI footprint.

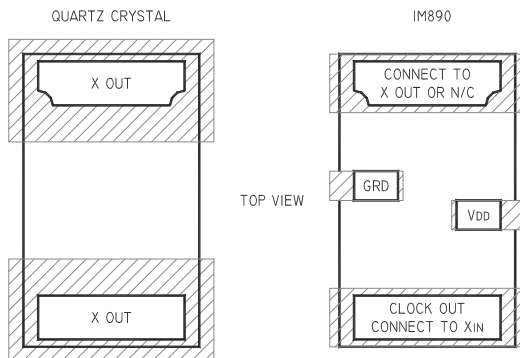

Figure 2 IM890 Footprint Compatibility with Quartz Crystal Footprint

Frequency Stability

The IM890 is factory calibrated (trimmed) to guarantee frequency stability to be less than 20 ppm at room temperature and less than 100 ppm over the full -40°C to +85°C temperature range. Unlike quartz crystals that have a classic tuning fork parabola temperature curve with a 25°C turnover point, the IM890 temperature coefficient is extremely flat across temperature. The device maintains less than 100 ppm frequency stability over the full operating temperature range when the operating voltage is between 1.5 and 3.63V.

Functionality is guaranteed over the 1.2V - 3.63V operating supply voltage range. However, frequency stability degrades below 1.5V and steadily degrades as it approaches the 1.2V minimum supply due to the internal regulator limitations. Between 1.2V and 1.5V, the frequency stability is 250 ppm max over temperature.

When measuring the IM890 output frequency with a frequency counter, it is important to make sure the counter's gate time is ≥ 100 ms. The slow frequency of a 32 kHz clock will give false readings with faster gate times.

Power Supply Noise Immunity

The IM890 is an ultra-small 32 kHz oscillator. In addition to eliminating external output load capacitors common with standard XTALs, this device includes special power supply filtering and thus, eliminates the need for an external Vdd bypass-decoupling capacitor. This feature further simplifies the design and keeps the footprint as small as possible. Internal power supply filtering is designed to reject AC-noise greater than ± 150 mVpp magnitude and beyond 10 MHz frequency component.

Output Voltage

The IM890 has two output voltage options. One option is a standard LVCMOS output swing. The second option is the NanoDrive reduced swing output. Output swing is customer specific and programmed between 200 mV and 800 mV. For DC-coupled applications, output V_{OH} and V_{OL} are individually factory programmed to the customers' requirement. V_{OH} programming range is between 600 mV and 1.225V in 100 mV increments. Similarly, V_{OL} programming range is between 350 mV and 800 mV. For example; a PMIC or MCU is internally 1.8V logic compatible, and requires a 1.2V V_{IH} and a 0.6V V_{IL} .

Simply select IM890 NanoDrive factory programming code to be "D14" and the correct output thresholds will match the downstream PMIC or MCU input requirements. Interface logic will vary by manufacturer and we recommend that you review the input voltage requirements for the input interface.

For DC-biased NanoDrive output configuration, the minimum V_{OL} is limited to 350mV and the maximum allowable swing ($V_{OH} - V_{OL}$) is 750mV. For example, 1.1V V_{OH} and 400mV V_{OL} is acceptable, but 1.2V V_{OH} and 400 mV V_{OL} is not acceptable.

When the output is interfacing to an XTAL input that is internally AC-coupled, the IM890 output can be factory programmed to match the input swing requirements. For example, if a PMIC or MCU input is internally AC-coupled and requires an 800mV swing, then simply choose the IM890 NanoDrive programming code "AA8" in the part number. It is important to note that the IM890 does not include internal AC-coupling capacitors. Please see the *Part Number Ordering* section of the datasheet for more information about the part number ordering scheme.

Power-up

The IM890 starts-up to a valid output frequency within 300 ms (150ms typ). To ensure the device starts-up within the specified limit, make sure the power-supply ramps-up in approximately 10 - 20 ms (to within 90% of Vdd). Start-up time is measured from the time Vdd reaches 1.5V. For applications that operate between 1.2V and 1.5V, the start-up time will be longer.

IM890 NanoDrive™

Figure 4 shows a typical IM890 output waveform (into a 10 pF load) when factory programmed for a 0.70V swing and DC bias (V_{OH}/V_{OL}) for 1.8V logic:

Example:

- NanoDrive™ part number coding: D14.
- Example part number: IM890-ID14-32.768
- $V_{OH} = 1.1V$, $V_{OL} = 0.4V$ ($V_{sw} = 0.70V$)

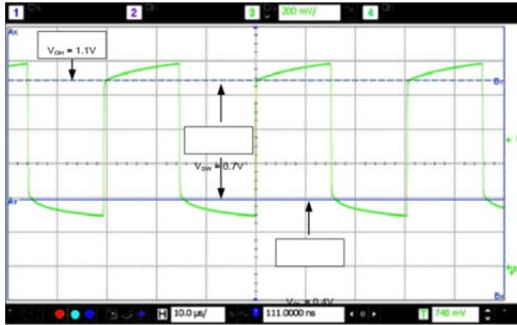

Figure 4. IM890-ID14-32.768 Output Waveform (10 pF Load)

IM890 Full Swing LVCMOS Output

The IM890 can be factory programmed to generate full-swing LVCMOS levels. Figure 5 shows the typical LVCMOS waveform ($V_{dd} = 1.8V$) at room temperature into a 15 pF load.

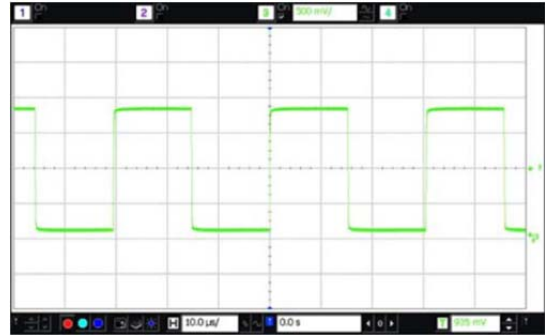

Figure 5. LVCMOS Waveform $V_{dd} = +1.8 V$ into 15pF Load

Table 1 shows the supported NanoDrive™ V_{OH} , V_{OL} factory programming options.

Table 1. Acceptable V_{OH}/V_{OL} NanoDrive™ Levels

V_{OL}/V_{OH}	1.225	1.100	1.000	0.900	0.800	0.700	0.600
0.800	D28	D18	D08				
0.700	D27	D17	D07	D97			
0.525	D26	D16	D06	D96	D86		
0.500	D25	D15	D05	D95	D85	D75	
0.400		D14	D04	D94	D84	D74	D64
0.350		D13	D03	D93	D83	D73	D63

Table 2 shows the supported AC coupled Swing levels. The “AC-coupled” terminology refers to the programming description for applications where the downstream chipset includes an internal AC-coupling capacitor, and therefore, only the output swing is important and V_{OH}/V_{OL} are not relevant.

Table 2. Acceptable AC-Coupled Swing Levels

Swing	0.800	0.700	0.600	0.500	0.400	0.300	0.250	0.200
Output Code	AA8	AA7	AA6	AA5	AA4	AA3	AA2	AA1

Example:

- NanoDrive part number coding: AA2. Example part number: IM890-4AA2-32.768
- Output voltage swing: 0.250V

The values listed in Tables 1 and -2 are nominal values at 25°C and will exhibit a tolerance of ± 55 mV across V_{dd} and -40°C to 85°C operating temperature range.

Example:

- LVCMOS output part number coding is always DCC
- Example part number: IM890-4DCC-32.768

Calculating Load Current

No Load Supply Current

When calculating no-load power for the IM890, the core and output driver components need to be added. Since the output voltage swing can be programmed for reduced swing between 250 mV and 800 mV, the output driver current is variable. Therefore, no-load operating supply current is broken into two sections; core and output driver. The equation is as follows:

$$\text{Total Supply Current (no load)} = I_{dd} \text{ Core} + (65nA/V)(V_{out_{pp}})$$

Example 1: Full-swing LVCMOS

- $V_{dd} = 1.8V$
- $I_{dd} \text{ Core} = 900nA$ (typ)
- $V_{out_{pp}} = 1.8V$ (LVCMOS)

$$\text{Supply Current} = 900nA + (65nA/V)(1.8V) = 1017nA$$

Example 2: NanoDrive™ Reduced Swing

- $V_{dd} = 1.8V$
- $I_{dd} \text{ Core} = 900nA$ (typ)
- $V_{out_{pp}} \text{ (Programmable)} = V_{OH} - V_{OL} = 1.1V - 0.6V = 500$ mV

$$\text{Supply Current} = 900nA + (65nA/V)(0.5V) = 932nA$$

Total Supply Current with Load

To calculate the total supply current, including the load, follow the equation listed below. Note the 30% reduction in power with NanoDrive™.

Total Current = I_{dd} Core + I_{dd} Output Driver (65nA/V*V_{out_pp})
+ Load Current (C*V*F)

Example 1: Full-swing LVCMOS

- V_{dd} = 1.8V
- I_{dd} Core = 900nA
- Load Capacitance = 10pF
- I_{dd} Output Driver: (65nA/V)(1.8V) = 117nA
- Load Current: (10pF)(1.8V)(32.768kHz) = 590nA
- Total Current = 900nA+117nA+590nA = 1.6μA

Example 2: NanoDrive™ Reduced Swing

- V_{dd} = 1.8V
- I_{dd} Core = 900nA
- Load Capacitance = 10pF
- V_{out_pp} (Programmable): V_{OH} - V_{OL} = 1.1V - 0.6V = 500mV
- I_{dd} Output Driver: (65nA/V)(0.5V) = 33nA
- Load Current: (10pF)(0.5V)(32.768kHz) = 164nA
- Total Current = 900nA + 33nA + 164nA = 1.1μA

Environmental Specifications:

Environmental Compliance	
Parameter	Condition/Test Method
Mechanical Shock	MIL-STD-883F, Method 2002
Mechanical Vibration	MIL-STD-883F, Method 2007
Temperature Cycle	JESD22, Method A104
Solderability	MIL-STD-883F, Method 2003
Moisture Sensitivity Level	MSL Level 1 at +260°C

Pb Free Solder Reflow Profile

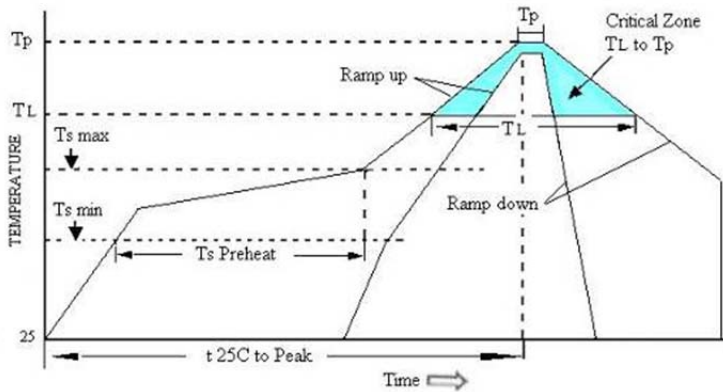

Ts max to TL (Ramp-up Rate)	3°C / second max
Preheat	
Temperature min (Ts min)	150°C
Temperature typ (Ts typ)	175°C
Temperature max (Ts max)	200°C
Time (Ts)	60 to 180 seconds
Ramp-up Rate (TL to Tp)	3°C / second max
Time Maintained Above Temperature (TL)	217°C
Time (TL)	60 to 150 seconds
Peak Temperature (Tp)	260°C max for seconds
Time within 5°C to Peak Temperature (Tp)	20 to 40 seconds
Ramp-down Rate	6°C / second max
Time 25°C to Peak Temperature	8 minute max
Moisture Sensitivity Level (MSL)	Level 1

Units are backward compatible with +240°C reflow processes

Typical Operating Curves ($T_A = 25^\circ\text{C}$, $V_{dd} = 1.8\text{V}$, unless otherwise stated)

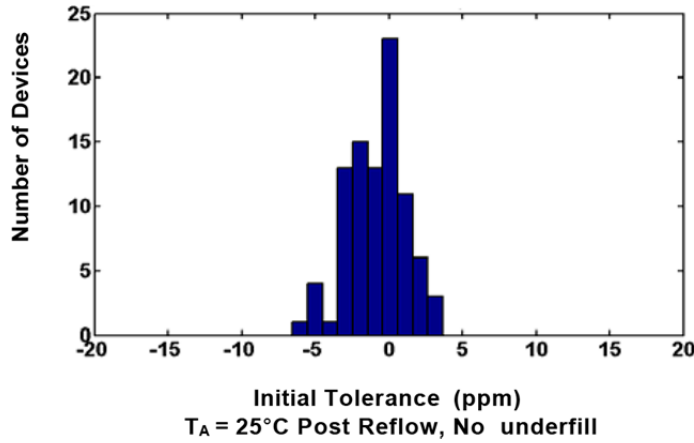

Initial Tolerance Histogram
 $T_A = 25^\circ\text{C}$ Post Reflow, No underfill

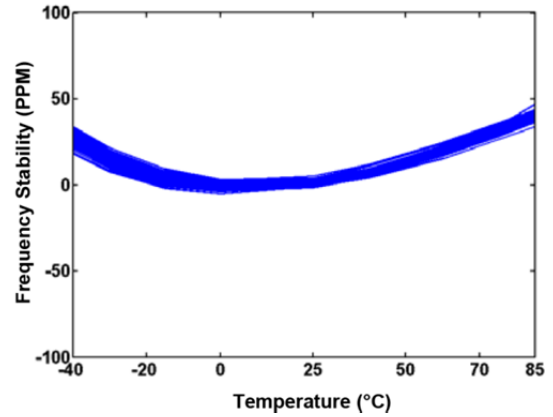

Frequency Stability Over Temperature

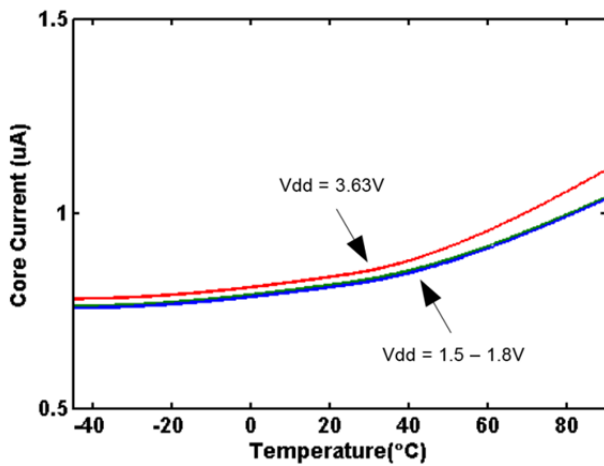

Core Current Over Temperature

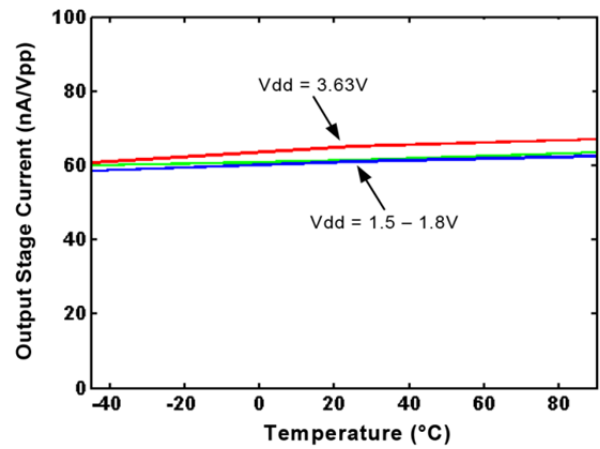

Output Stage Current Over Temperature

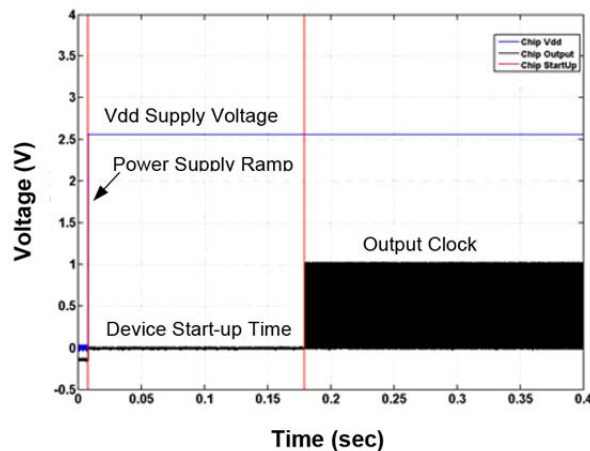

Start-up Time

Typical Operating Curves (cont.)

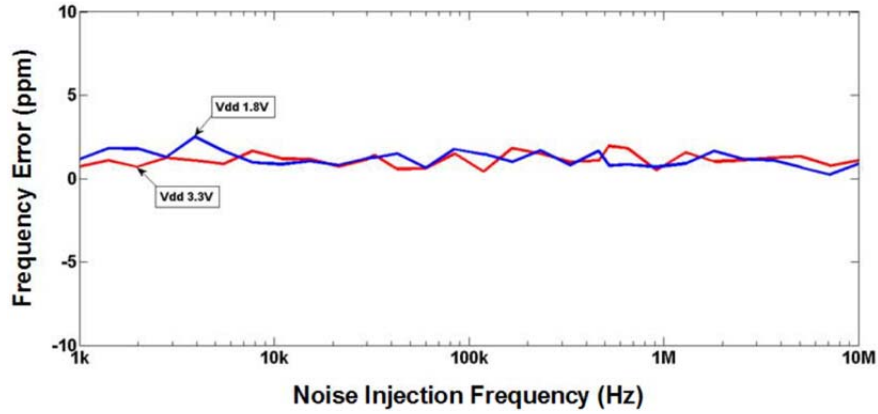

Power Supply Noise Rejection
(± 150 mV Noise)

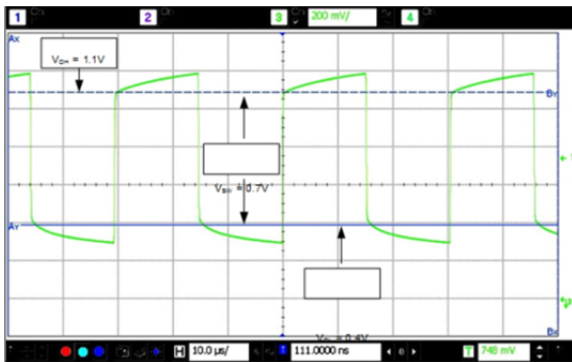

NanoDrive™ Output Waveform
V_{oh} = 1.1V, V_{ol} = 0.4V; IM890-ID14-32.768

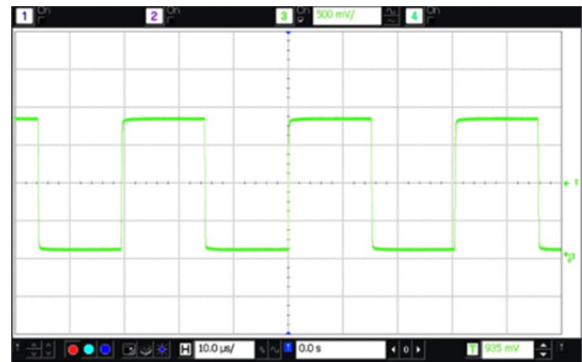

LVC MOS Output Waveform
V_{swing} = 1.8V; IM890-IDCC-32.768

Mechanical Details:

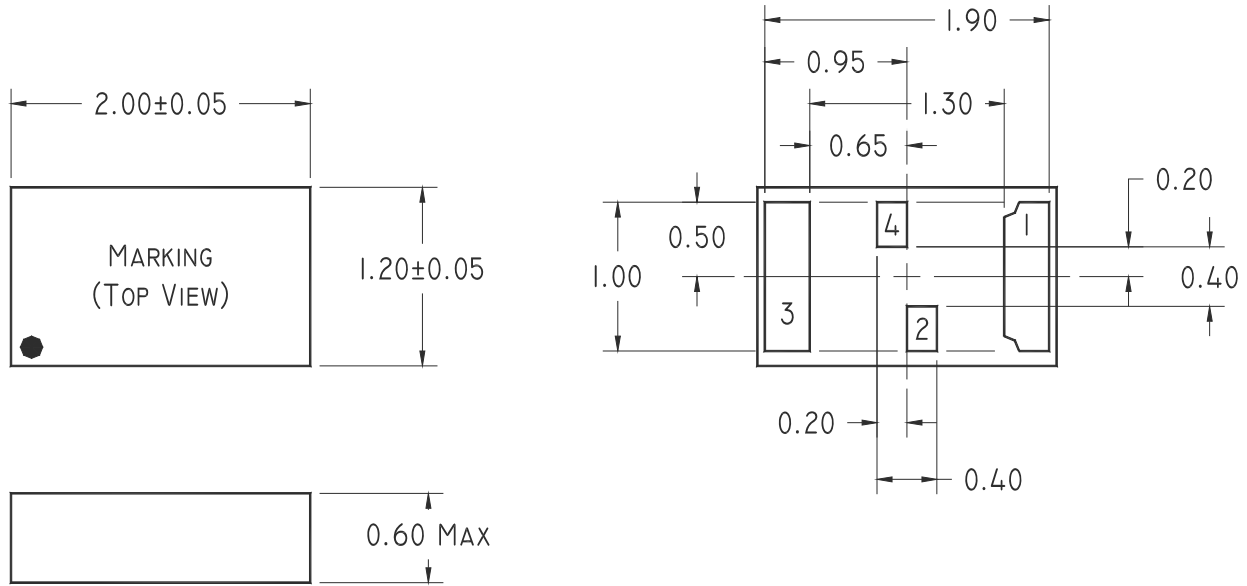

2.0 x 1.2 mm SMD Package

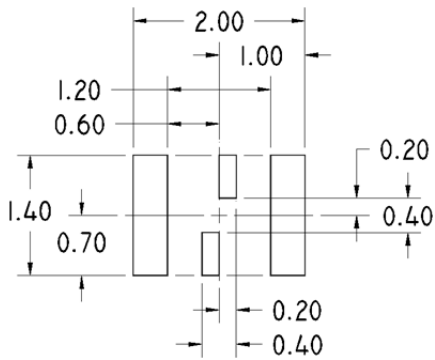

IM890 Series

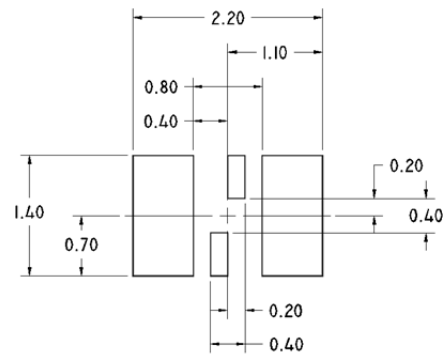

XTAL Compatible

Suggested Land Pattern

Marking

Line 1 = XXXXX (Lot code)
Dot to denote Pin 1 location

Package Information

Leadframe: C194
Plating: NiPdAu

Notes:

- All dimensions are in mm.
- Do not scale drawings.

X-ON Electronics

Largest Supplier of Electrical and Electronic Components

Click to view similar products for ILSI manufacturer:

Other Similar products are found below :

[HC49USM-FF5F18-7.3728](#) [IM801C-32-AH-27.0000](#) [ISM97-1351AH-12.0000](#) [IM801E-32-AH-20.0000](#) [I547-2P3-32.0000 MHZ](#) [IM801E-32-AH-32.0000](#) [HC49USM-FF3F18-10.0000](#) [IM801C-32-AH-14.7456](#) [HC49US-FF3F18-4.0000](#) [ISM81-3753BH-16.0000](#) [IM801D-32-AH-50.0000](#) [I733-2P3-40.0000 MHZ](#) [IM801C-32-AH-66.6660](#) [IM801C-32-AH-8.0000](#) [IM801C-32-AH-14.31818](#) [IM801D-32-AH-27.0000](#) [IM801E-32-AH-10.0000](#) [IM801C-32-AH-60.0000](#) [I537-2P3-32.0000MHZ](#) [IM801D-32-AH-30.0000](#) [IM801D-32-AH-32.0000](#) [IM801D-32-AH-64.0000](#) [IM801D-32-AH-66.6660](#) [ISM81-3753BH-20.0000](#) [IM801C-32-AH-25.0000](#) [ISM81-3753BH-24.0000](#) [HC49USM-FF5F18-8.0000](#) [IM801E-32-AH-14.31818](#) [IM801E-32-AH-48.0000](#) [ISM81-3753BH-40.0000](#) [IM801D-32-AH-33.3330](#) [IM801D-32-AH-3.6864](#) [IM801D-32-AH-60.0000](#) [IM801E-32-AH-3.6864](#) [IM801E-32-AH-64.0000](#) [IM801E-32-AH-66.6660](#) [IM801C-32-AH-33.3330](#) [IM801E-32-AH-27.0000](#) [IM801E-32-AH-30.0000](#) [IM801E-32-AH-33.3330](#) [IM801E-32-AH-60.0000](#) [IM802C-32-AH-125.0000](#) [HC49USM-FF3F18-16.0000](#) [ISM92-3351AH-33.3330](#) [ILCX04-436-28.2](#) [HC49US-FF5F18-7.3728](#) [IM801C-32-AH-24.0000](#) [ISM82-3753BH-20.0000](#) [ISM97-6351BH-50.000MHZ](#) [I733-2P3-19.2000 MHZ](#)