

# SKiiP 13AC126V1

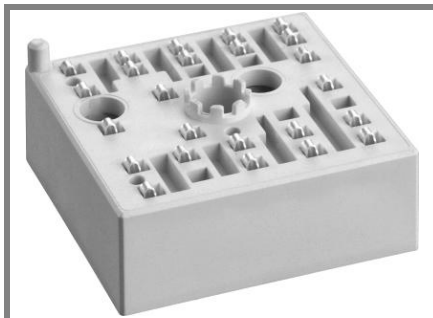

MiniSKiiP<sup>®</sup> 1

## 3-phase bridge inverter

### SKiiP 13AC126V1

#### Features

- Fast Trench IGBTs
- Robust and soft freewheeling diodes in CAL technology
- Highly reliable spring contacts for electrical connections
- UL recognised file no. E63532

#### Typical Applications\*

- Inverter up to 16 kVA
- Typical motor power 7.5 kW

#### Remarks

- $V_{CEsat}$ ,  $V_F$  = chip level value

Absolute Maximum Ratings		$T_s = 25\text{ °C}$ , unless otherwise specified	
Symbol	Conditions	Values	Units
<b>IGBT - Inverter</b>			
$V_{CES}$	$T_s = 25\text{ (70) °C}$ $t_p \leq 1\text{ ms}$	1200	V
$I_C$		41 (31)	A
$I_{CRM}$		50	A
$V_{GES}$		$\pm 20$	V
$T_j$		- 40 ... + 150	°C
<b>Diode - Inverter</b>			
$I_F$	$T_s = 25\text{ (70) °C}$ $t_p \leq 1\text{ ms}$	30 (22)	A
$I_{FRM}$		50	A
$T_j$		- 40 ... + 150	°C
$I_{tRMS}$	per power terminal (20 A / spring)	40	A
$T_{stg}$	$T_{op} \leq T_{stg}$	- 40 ... + 125	°C
$V_{isol}$	AC, 1 min.	2500	V

Characteristics		$T_s = 25\text{ °C}$ , unless otherwise specified			
Symbol	Conditions	min.	typ.	max.	Units
<b>IGBT - Inverter</b>					
$V_{CEsat}$	$I_{Cnom} = 25\text{ A}$ , $T_j = 25\text{ (125) °C}$		1,7 (2)	2,1 (2,4)	V
$V_{GE(th)}$	$V_{GE} = V_{CE}$ , $I_C = 1\text{ mA}$	5	5,8	6,5	V
$V_{CE(TO)}$	$T_j = 25\text{ (125) °C}$		1 (0,9)	1,2 (1,1)	V
$r_T$	$T_j = 25\text{ (125) °C}$		28 (44)	36 (52)	mΩ
$C_{ies}$	$V_{CE} = 25\text{ V}$ , $V_{GE} = 0\text{ V}$ , $f = 1\text{ MHz}$		1,8		nF
$C_{oes}$	$V_{CE} = 25\text{ V}$ , $V_{GE} = 0\text{ V}$ , $f = 1\text{ MHz}$		0,3		nF
$C_{res}$	$V_{CE} = 25\text{ V}$ , $V_{GE} = 0\text{ V}$ , $f = 1\text{ MHz}$		0,2		nF
$R_{th(j-s)}$	per IGBT		0,9		K/W
$t_{d(on)}$	under following conditions		95		ns
$t_r$	$V_{CC} = 600\text{ V}$ , $V_{GE} = \pm 15\text{ V}$		35		ns
$t_{d(off)}$	$I_{Cnom} = 25\text{ A}$ , $T_j = 125\text{ °C}$		455		ns
$t_f$	$R_{Gon} = R_{Goff} = 30\text{ Ω}$		85		ns
$E_{on}$	inductive load		4,1		mJ
$E_{off}$			3,1		mJ
<b>Diode - Inverter</b>					
$V_F = V_{EC}$	$I_{Fnom} = 25\text{ A}$ , $T_j = 25\text{ (125) °C}$		1,8 (1,8)	2,1 (2,2)	V
$V_{(TO)}$	$T_j = 25\text{ (125) °C}$		1 (0,8)	1,1 (0,9)	V
$r_T$	$T_j = 25\text{ (125) °C}$		32 (40)	40 (52)	mΩ
$R_{th(j-s)}$	per diode		1,7		K/W
$I_{RRM}$	under following conditions		25		A
$Q_{rr}$	$I_{Fnom} = 25\text{ A}$ , $V_R = 600\text{ V}$		5,3		μC
$E_{rr}$	$V_{GE} = 0\text{ V}$ , $T_j = 125\text{ °C}$		2,2		mJ
	$di_F/dt = 1140\text{ A/μs}$				
<b>Temperature Sensor</b>					
$R_{ts}$	3 %, $T_r = 25\text{ (100) °C}$		1000(1670)		Ω
<b>Mechanical Data</b>					
m			35		g
$M_s$	Mounting torque	2		2,5	Nm

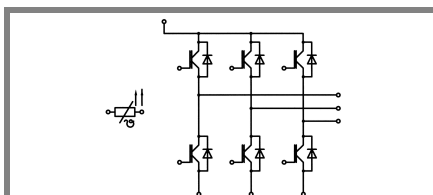

AC

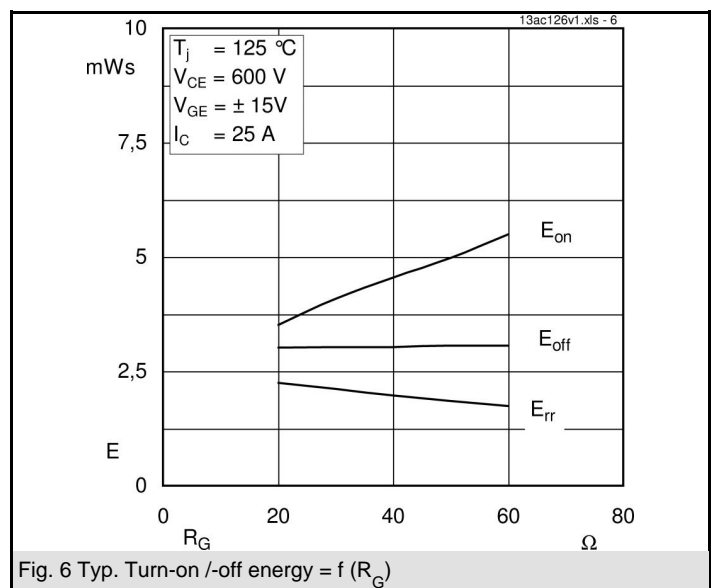
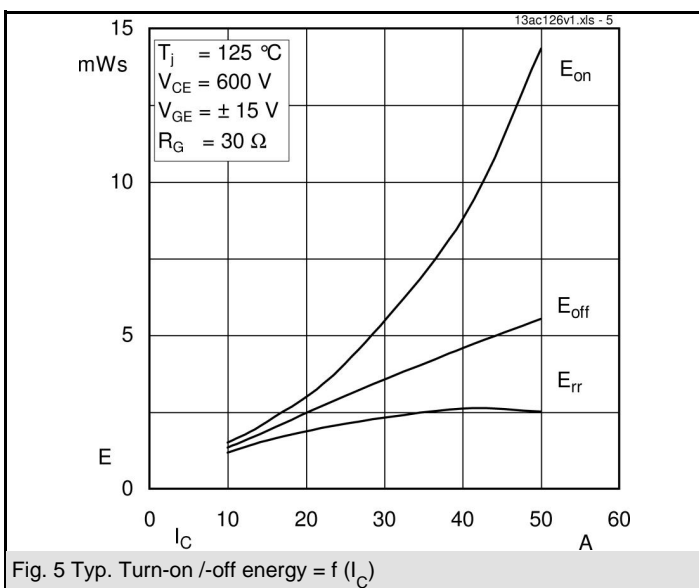
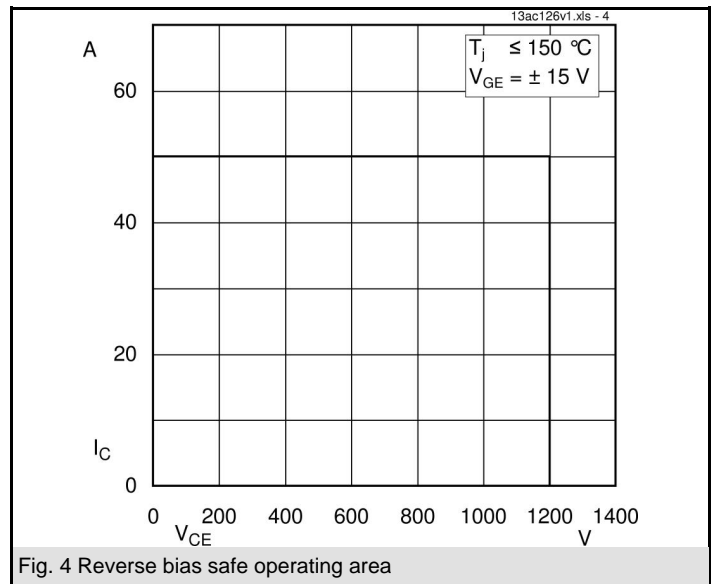
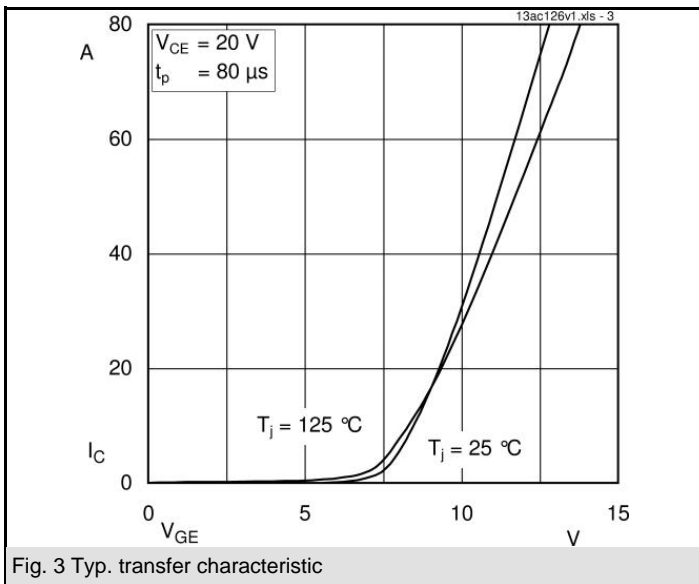
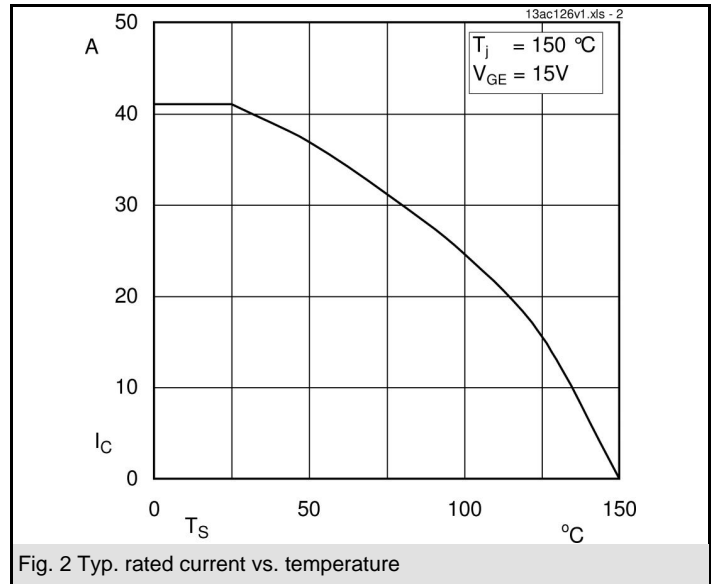
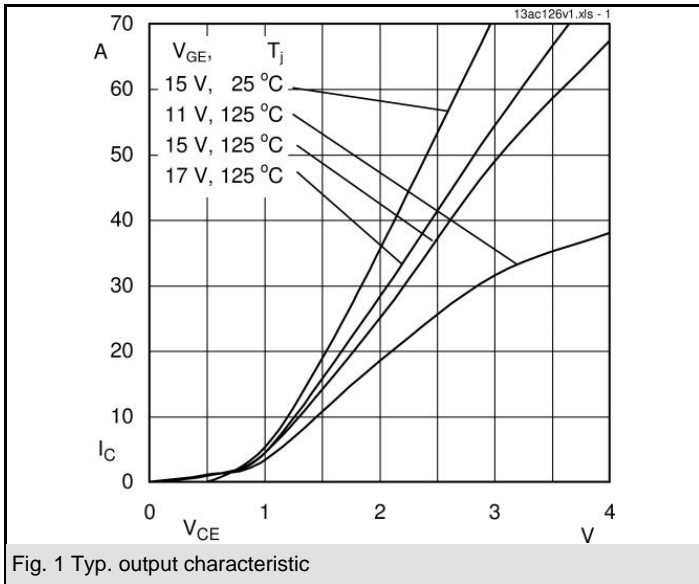

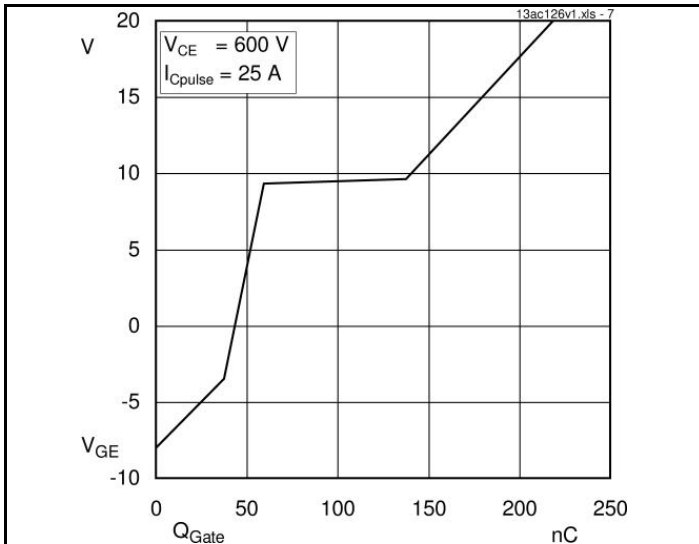

Fig. 7 Typ. gate charge characteristic

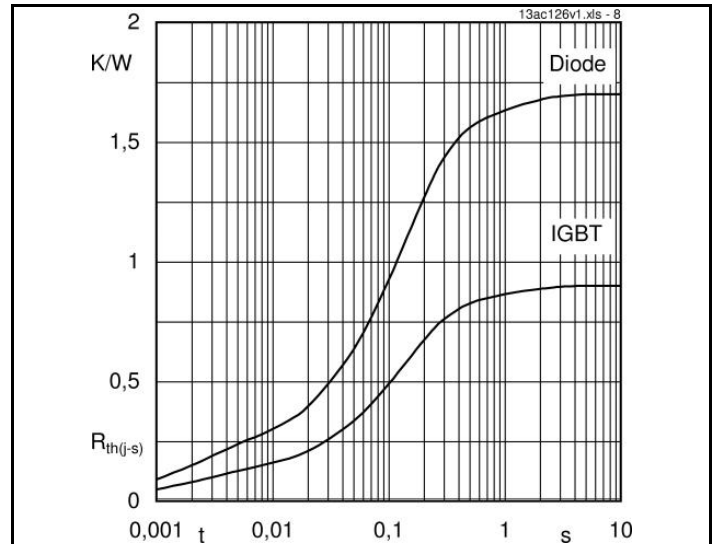

Fig. 8 Typ. thermal impedance

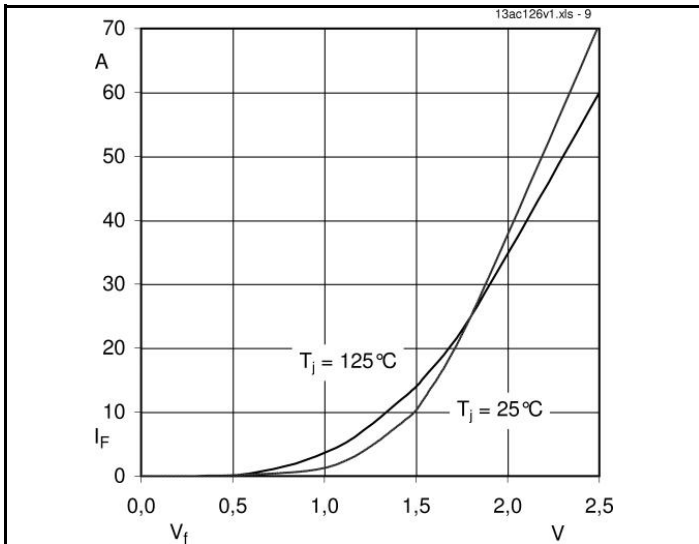
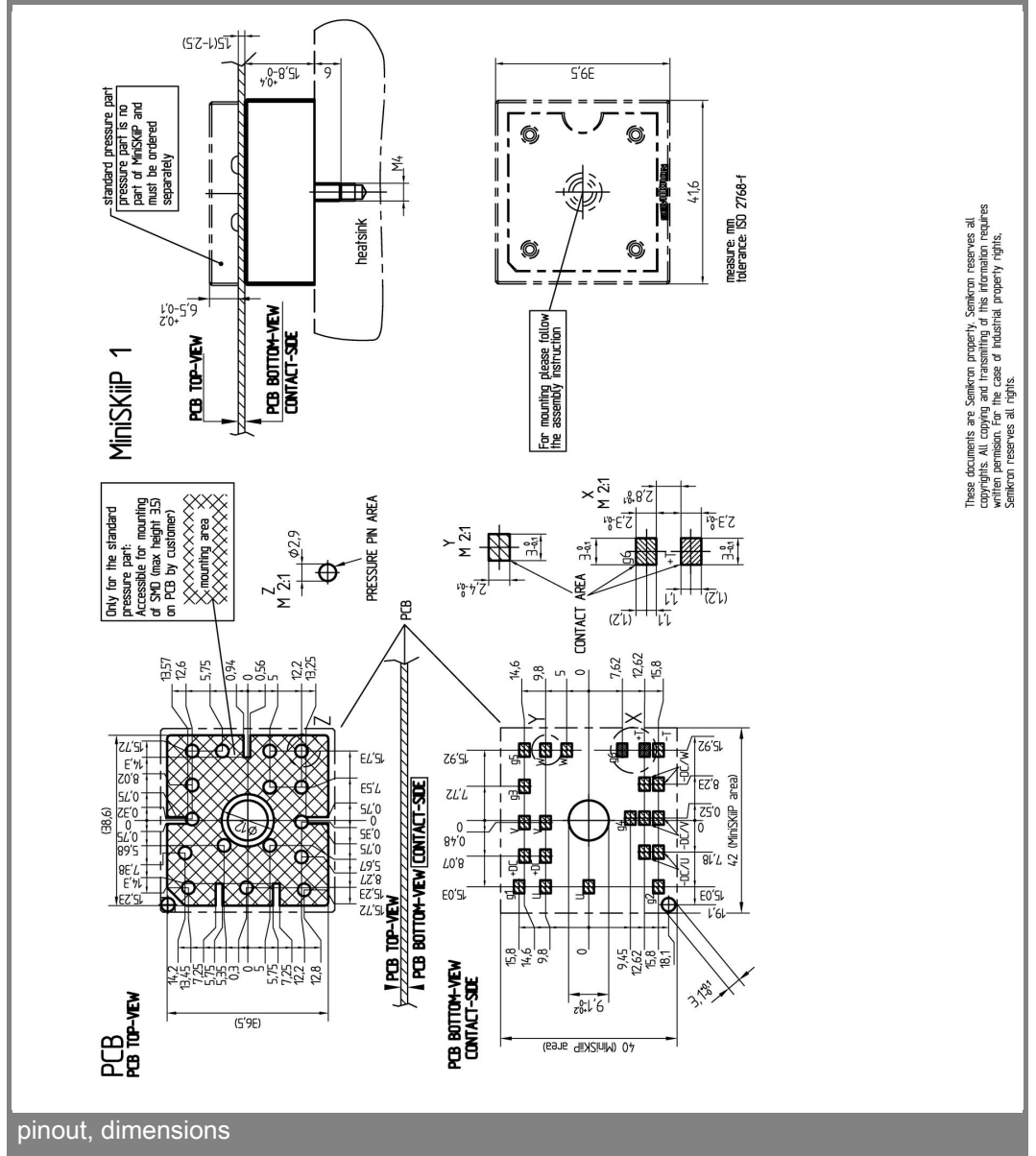
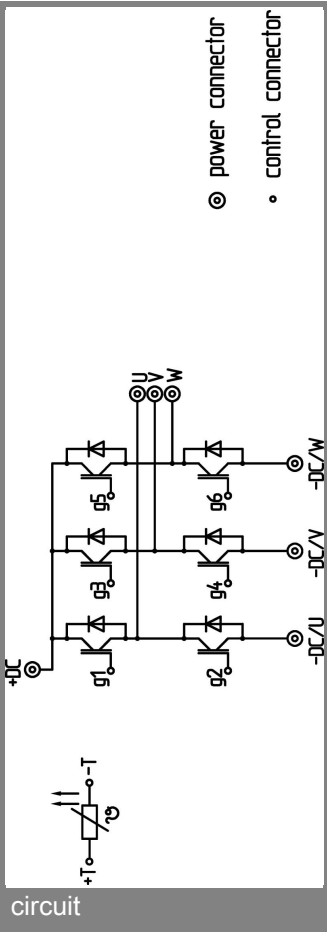

Fig. 9 Typ. freewheeling diode forward characteristic



These documents are Semikron property. Semikron reserves all copyrights. All copying and transmitting of this information requires written permission. For the case of industrial property rights, Semikron reserves all rights.

This is an electrostatic discharge sensitive device (ESDS), international standard IEC 60747-1, Chapter IX.

\* The specifications of our components may not be considered as an assurance of component characteristics. Components have to be tested for the respective application. Adjustments may be necessary. The use of SEMIKRON products in life support appliances and systems is subject to prior specification and written approval by SEMIKRON. We therefore strongly recommend prior consultation of our personal.

## X-ON Electronics

Largest Supplier of Electrical and Electronic Components

*Click to view similar products for [Semikron](#) manufacturer:*

Other Similar products are found below :

[SKD 51/16](#) [SKKT 42B12 E](#) [SKKT 57/12E](#) [SKM 200GAR125D](#) [SKR 141F15](#) [SKB 60/08](#) [SKKH 122/16E](#) [SKYPER 32 R](#) [SKKD 260/16](#)  
[SKKL 92/16E](#) [SKD 31/08](#) [SKD 62/12](#) [SKKD 380/08](#) [SKKH 162/18E](#) [SKKH 72/20E H4](#) [SKKT 250/12E](#) [SKYPER 32 R UL](#) [SKN 100/12](#)  
[SKIIP 24AC12T4V1 M20](#) [SKIIP 39AC126V2 M20](#) [SKIIP 39ANB16V1 M20](#) [SKKH 570/16E](#) [SKD 30/04A1](#) [SKM 400GAL12E4](#) [SK 25 UT](#)  
[12](#) [SKR70/04](#) [SKD 30/16A1](#) [SKKT 42/08E](#) [SKBT 40/12](#) [SKCH 40/08](#) [SKD 110/08](#) [SKD 210/18](#) [SKD 82/08](#) [SKN 60F15](#) [SKR 60F12](#)  
[SKB 30/04A1](#) [SKR 100/12](#) [SKIIP 28ANB16V2 M20](#) [SKIIP 35NAB126V10 M20](#) [SKB 60/04](#) [SKB 60/12](#) [SKD 60/16](#) [SKDT 60/12](#) [SKKT](#)  
[106/18E](#) [SKR 130/14](#) [SKB 60/16](#) [SKCH 40/16](#) [SKKH 106/14E](#) [SKKT 106B12 E](#) [SKKT 570/16E](#)