

Data sheet

Connection line M12 jack straight - RJ45 plug straight 4-pole, D-coded 0.5 m

Page 1/6

P/N
142M4D25005
EAN 4251394600765

2018-26-02

Illustrations



Dimensional drawing

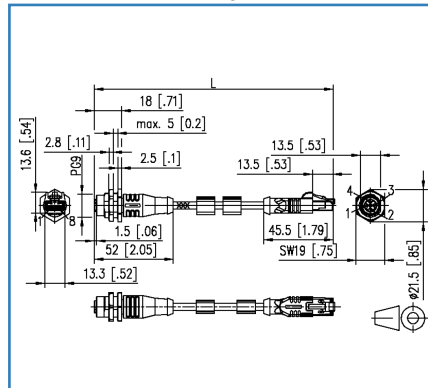

Cut-out

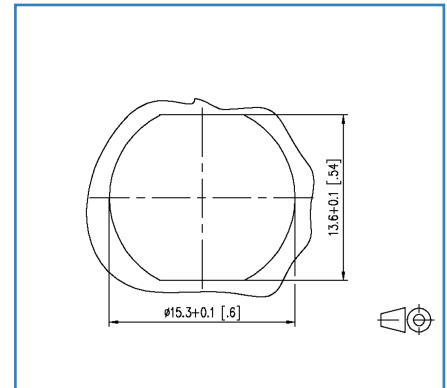

See enlarged drawings at the end of document

Product specification

- shielded M12-jack to RJ45-plug Ethernet connection line
- Cat.5, 4-pole, D-coded (IEC 61076-2-101)
- side 1: M12 jack, straight
- side 2: RJ45 plug, straight
- extrusion-coated cable on connectors
- stranded wires 1x4xAWG26/19
- overall shield tinned copper braid
- pin assignment per Profinet
- green cable, PUR
- standard variants: 1.0 m, 2.0 m, 3.0 m, 5.0 m, 10.0 m
- other cable lengths on request



Data sheet

Page 2/6

Connection line M12 jack straight - RJ45 plug straight 4-pole, D-coded 0.5 m

P/N

142M4D25005

EAN 4251394600765

2018-26-02

Technical Data

General Data

Fields of application	Industrial Ethernet
Design	Ethernet-Connection line
Shielding	shielded
Transmission technology	Copper
Cable Type	S/UTP
Number of twisting elements	4
Twisting element	single core
Wiring	Profinet
Color coding fiber/ wire(s)	white/orange, white/blue, orange, blue
Color	green
Dimensions	
Dimension - Interface 1 (L)	52.00 mm
Dimension - Interface 1 (L)	2.047 in.
Dimension - Interface 2 (L)	45.50 mm
Dimension - Interface 2 (L)	1.791 in.
Cable length (m)	0.50 m
Weight	31 kg/km
Labeling option	identification label carrier

Transmission characteristics

Category (ISO)	5
----------------	---

Connections/interfaces

Connector technology interface 1	M12-jack
Connector technology interface 2	RJ45 plug
Coding interface 1	data systems technology tool
Number of positions/contacts interface 1	4
Number of positions/contacts interface 2	8P/4C
Termination data, stranded wire (min. - max.)	
Conductor cross section, stranded wire	AWG 26/19

Data sheet

Page 3/6

Connection line M12 jack straight - RJ45 plug straight 4-pole, D-coded 0.5 m

P/N

142M4D25005

EAN 4251394600765

2018-26-02

Technical Data

Connections/interfaces

Cable sheath diameter (min. - max.)

Cable sheath diameter 4.80 mm

Cable sheath diameter 0.189 in.

Electrical characteristics

Current carrying capacity max. 4, max. 1 A

Insulation resistance min. 100 MOhm

Mechanical characteristics

Maximum operating bending radius 19 mm

Maximum operating bending radius 0.748 in.

Maximum installation load 36 mm

Maximum installation load 1.417 in.

Shielding braid coverage 85 %

Materials and material properties

Material - Conductor Cu (copper)

Material - Conductor Insulation polypropylene

Material - Cable jacket PUR

Material - Body interface 1 Plastics

Material - Body interface 2 Plastics

Material - Contact interface 1 CuSn (tin bronze)

Material - Contact interface 2 CuSn (tin bronze)

Material - Contact finish interface 1 Au (gold)

Material - Contact finish interface 2 Au (gold)

Material - Contact carriers interface 1 Plastics

Material - Contact carriers interface 2 Plastics

Material - Union nut interface 1 CuZn (brass)

Material - Union nut finish interface 1 Ni (nickel)

Material - Main shield Cu (copper) braid

Material - Main shield finish Sn (tin)

Flame retardancy yes

Halogen free yes

Silicone free yes

Oil resistance yes

Data sheet

Page 4/6

Connection line M12 jack straight - RJ45 plug straight 4-pole, D-coded 0.5 m

P/N

142M4D25005

EAN 4251394600765

2018-26-02

Technical Data

Materials and material properties

UV-resistance yes

Environmental conditions

Temperature (min. - max.)

Temperature - Operating °C -30 - 70 °C

Temperature - Operating °F -22 - 158 °F

Particulate ingress interface 1 IP6X when plugged in

Liquid ingress/immersion interface 1 IPX5, IPX7, IPX8 when plugged in

Particulate ingress interface 2 IP2X im gesteckten Zustand

Liquid ingress/immersion interface 2 IPX0 when plugged in

Pollution degree interface 1 3

Pollution degree interface 2 1

Approvals

RoHS compliant

The product meets the following standards

Profinet yes

Connectors for electronic equipment

circular connector DIN EN 61076-2-101

Test for vertical flame propagation for a single insulated wire or cable DIN EN 60332-1-2

Packing details

Type of packaging 1 pc(s) / plastic bag



Data sheet

Page 5/6

**Connection line M12 jack straight - RJ45 plug straight
4-pole, D-coded 0.5 m**

P/N

142M4D25005

EAN 4251394600765

2018-26-02

Illustrations

Dimensional drawing

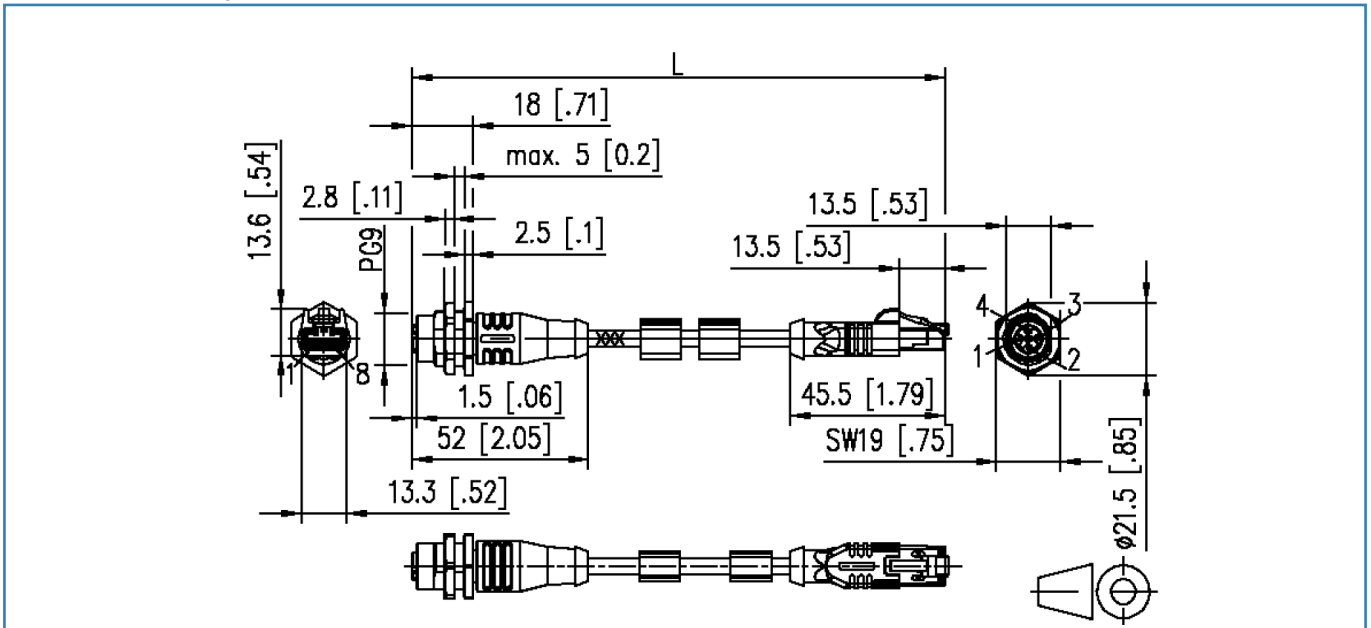

Cut-out

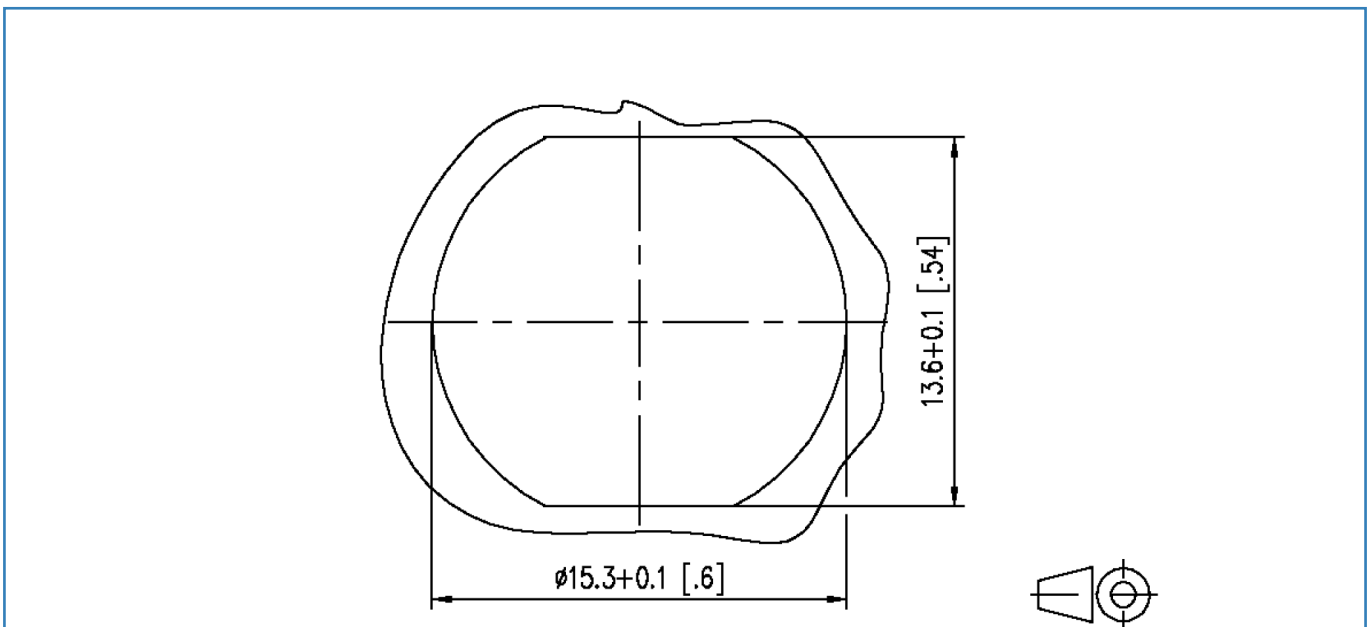

Data sheet

Page 6/6

Connection line M12 jack straight - RJ45 plug straight 4-pole, D-coded 0.5 m

P/N

142M4D25005

EAN 4251394600765

2018-26-02

Illustrations

Wiring

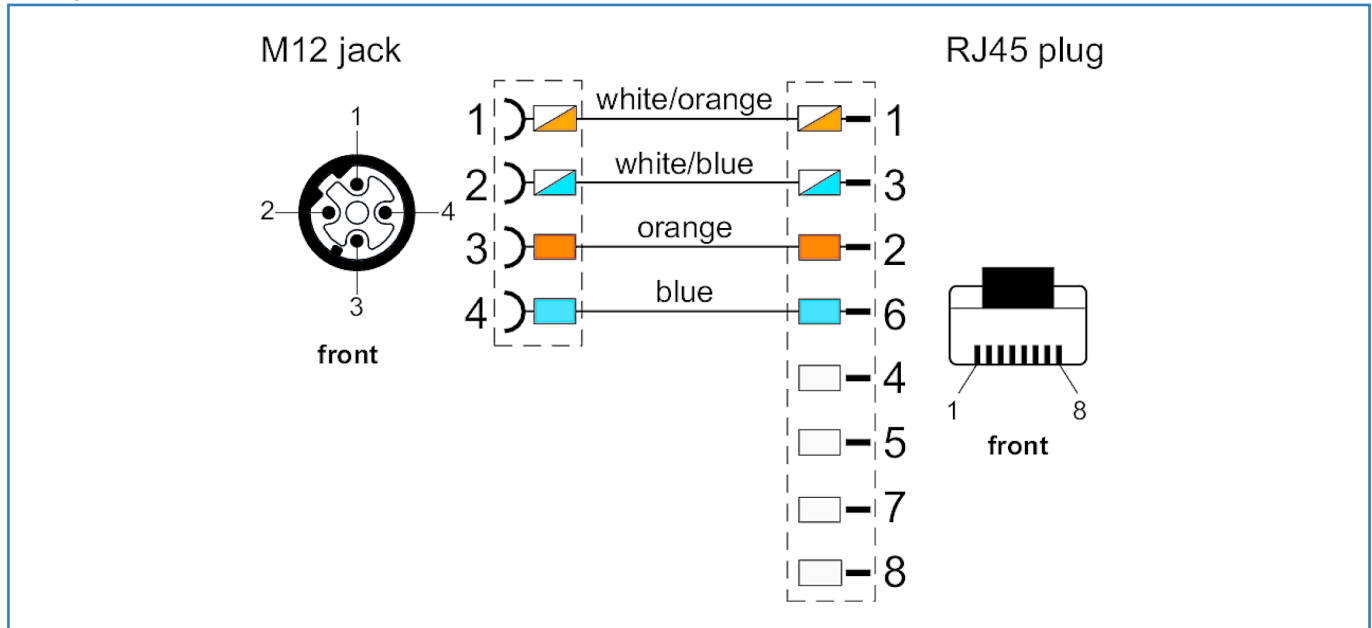

X-ON Electronics

Largest Supplier of Electrical and Electronic Components

Click to view similar products for [Metz manufacturer](#):

Other Similar products are found below :

[142M4D95050](#) [ASP0631006](#) [4898-454G](#) [4895-454G](#) [4887-454G](#) [4897-454G](#) [ASP0460622](#) [142M2X25005](#) [ASP0440222](#) [1108861321](#)
[1108311319](#) [1108501319](#) [11089313](#) [834HTC-900ML](#) [130920-E](#) [150240C30610E](#) [110304412004](#) [1108831326](#) [150240C30310S](#) [135015-](#)
[SSC-E](#) [1528SBGT19E](#) [1401110012KE](#) [142M2X15010](#) [11085813](#) [810-500](#) [810-50](#) [31336104](#) [ASP0430922](#) [SP06502VBNF](#) [31217103](#)
[142M1D19020](#) [SR99S01VBNN0001](#) [31213102](#) [31251104](#) [AST0820406](#) [1108811319](#) [142M2XB5050](#) [834B-375ML](#) [841ER-1.17L](#)
[31009105](#) [31020205](#) [31024102](#) [31027103](#) [31383106](#) [130922-03-E](#) [130924-E](#) [11027605](#) [1108841319](#) [1108341319](#) [15024AD206-E](#)