

R&S®NRP-Zxx Power Sensors Getting Started



1176.8822.02 – 03

This manual gives an introduction to the Rohde & Schwarz NRP-Z sensors.

The software contained in this product uses several valuable open source software packages. For information, see the "Open Source Acknowledgment" on the user documentation CD-ROM (included in delivery).

Rohde & Schwarz would like to thank the open source community for their valuable contribution to embedded computing.

© 2017 Rohde & Schwarz GmbH & Co. KG

Mühlhofstr. 15, 81671 München, Germany

Phone: +49 89 41 29 - 0

Fax: +49 89 41 29 12 164

Email: info@rohde-schwarz.com

Internet: www.rohde-schwarz.com

Subject to change – Data without tolerance limits is not binding.

R&S® is a registered trademark of Rohde & Schwarz GmbH & Co. KG.

Trade names are trademarks of their owners.

Throughout this manual, products from Rohde & Schwarz are indicated without the ® symbol, for example R&S®NRP2 is abbreviated as R&S NRP2.

Basic Safety Instructions

Always read through and comply with the following safety instructions!

All plants and locations of the Rohde & Schwarz group of companies make every effort to keep the safety standards of our products up to date and to offer our customers the highest possible degree of safety. Our products and the auxiliary equipment they require are designed, built and tested in accordance with the safety standards that apply in each case. Compliance with these standards is continuously monitored by our quality assurance system. The product described here has been designed, built and tested in accordance with the EC Certificate of Conformity and has left the manufacturer's plant in a condition fully complying with safety standards. To maintain this condition and to ensure safe operation, you must observe all instructions and warnings provided in this manual. If you have any questions regarding these safety instructions, the Rohde & Schwarz group of companies will be happy to answer them.







Furthermore, it is your responsibility to use the product in an appropriate manner. This product is designed for use solely in industrial and laboratory environments or, if expressly permitted, also in the field and must not be used in any way that may cause personal injury or property damage. You are responsible if the product is used for any purpose other than its designated purpose or in disregard of the manufacturer's instructions. The manufacturer shall assume no responsibility for such use of the product.

The product is used for its designated purpose if it is used in accordance with its product documentation and within its performance limits (see data sheet, documentation, the following safety instructions). Using the product requires technical skills and, in some cases, a basic knowledge of English. It is therefore essential that only skilled and specialized staff or thoroughly trained personnel with the required skills be allowed to use the product. If personal safety gear is required for using Rohde & Schwarz products, this will be indicated at the appropriate place in the product documentation. Keep the basic safety instructions and the product documentation in a safe place and pass them on to the subsequent users.











Observing the safety instructions will help prevent personal injury or damage of any kind caused by dangerous situations. Therefore, carefully read through and adhere to the following safety instructions before and when using the product. It is also absolutely essential to observe the additional safety instructions on personal safety, for example, that appear in relevant parts of the product documentation. In these safety instructions, the word "product" refers to all merchandise sold and distributed by the Rohde & Schwarz group of companies, including instruments, systems and all accessories. For product-specific information, see the data sheet and the product documentation.

Safety labels on products

The following safety labels are used on products to warn against risks and dangers.

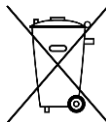
Symbol	Meaning	Symbol	Meaning
	Notice, general danger location Observe product documentation		ON/OFF Power
	Caution when handling heavy equipment		Standby indication
	Danger of electric shock		Direct current (DC)

Basic Safety Instructions

Symbol	Meaning	Symbol	Meaning
	Caution ! Hot surface		Alternating current (AC)
	Protective conductor terminal To identify any terminal which is intended for connection to an external conductor for protection against electric shock in case of a fault, or the terminal of a protective earth		Direct/alternating current (DC/AC)
	Earth (Ground)		Class II Equipment to identify equipment meeting the safety requirements specified for Class II equipment (device protected by double or reinforced insulation)
	Frame or chassis Ground terminal		EU labeling for batteries and accumulators For additional information, see section "Waste disposal/Environmental protection", item 1.
	Be careful when handling electrostatic sensitive devices		EU labeling for separate collection of electrical and electronic devices For additional information, see section "Waste disposal/Environmental protection", item 2.
	Warning! Laser radiation For additional information, see section "Operation", item 7.		

Signal words and their meaning

The following signal words are used in the product documentation in order to warn the reader about risks and dangers.



Indicates a hazardous situation which, if not avoided, will result in death or serious injury.



Indicates a hazardous situation which, if not avoided, could result in death or serious injury.



Indicates a hazardous situation which, if not avoided, could result in minor or moderate injury.



Indicates information considered important, but not hazard-related, e.g. messages relating to property damage.

In the product documentation, the word ATTENTION is used synonymously.

These signal words are in accordance with the standard definition for civil applications in the European Economic Area. Definitions that deviate from the standard definition may also exist in other economic areas or military applications. It is therefore essential to make sure that the signal words described here are always used only in connection with the related product documentation and the related product. The use of signal words in connection with unrelated products or documentation can result in misinterpretation and in personal injury or material damage.

Basic Safety Instructions

Operating states and operating positions

The product may be operated only under the operating conditions and in the positions specified by the manufacturer, without the product's ventilation being obstructed. If the manufacturer's specifications are not observed, this can result in electric shock, fire and/or serious personal injury or death. Applicable local or national safety regulations and rules for the prevention of accidents must be observed in all work performed.

1. Unless otherwise specified, the following requirements apply to Rohde & Schwarz products: predefined operating position is always with the housing floor facing down, IP protection 2X, use only indoors, max. operating altitude 2000 m above sea level, max. transport altitude 4500 m above sea level. A tolerance of $\pm 10\%$ shall apply to the nominal voltage and $\pm 5\%$ to the nominal frequency, overvoltage category 2, pollution degree 2.
2. Do not place the product on surfaces, vehicles, cabinets or tables that for reasons of weight or stability are unsuitable for this purpose. Always follow the manufacturer's installation instructions when installing the product and fastening it to objects or structures (e.g. walls and shelves). An installation that is not carried out as described in the product documentation could result in personal injury or even death.
3. Do not place the product on heat-generating devices such as radiators or fan heaters. The ambient temperature must not exceed the maximum temperature specified in the product documentation or in the data sheet. Product overheating can cause electric shock, fire and/or serious personal injury or even death.

Electrical safety

If the information on electrical safety is not observed either at all or to the extent necessary, electric shock, fire and/or serious personal injury or death may occur.

1. Prior to switching on the product, always ensure that the nominal voltage setting on the product matches the nominal voltage of the mains-supply network. If a different voltage is to be set, the power fuse of the product may have to be changed accordingly.
2. In the case of products of safety class I with movable power cord and connector, operation is permitted only on sockets with a protective conductor contact and protective conductor.
3. Intentionally breaking the protective conductor either in the feed line or in the product itself is not permitted. Doing so can result in the danger of an electric shock from the product. If extension cords or connector strips are implemented, they must be checked on a regular basis to ensure that they are safe to use.
4. If there is no power switch for disconnecting the product from the mains, or if the power switch is not suitable for this purpose, use the plug of the connecting cable to disconnect the product from the mains. In such cases, always ensure that the power plug is easily reachable and accessible at all times. For example, if the power plug is the disconnecting device, the length of the connecting cable must not exceed 3 m. Functional or electronic switches are not suitable for providing disconnection from the AC supply network. If products without power switches are integrated into racks or systems, the disconnecting device must be provided at the system level.
5. Never use the product if the power cable is damaged. Check the power cables on a regular basis to ensure that they are in proper operating condition. By taking appropriate safety measures and carefully laying the power cable, ensure that the cable cannot be damaged and that no one can be hurt by, for example, tripping over the cable or suffering an electric shock.

Basic Safety Instructions

6. The product may be operated only from TN/TT supply networks fuse-protected with max. 16 A (higher fuse only after consulting with the Rohde & Schwarz group of companies).
7. Do not insert the plug into sockets that are dusty or dirty. Insert the plug firmly and all the way into the socket provided for this purpose. Otherwise, sparks that result in fire and/or injuries may occur.
8. Do not overload any sockets, extension cords or connector strips; doing so can cause fire or electric shocks.
9. For measurements in circuits with voltages $V_{rms} > 30$ V, suitable measures (e.g. appropriate measuring equipment, fuse protection, current limiting, electrical separation, insulation) should be taken to avoid any hazards.
10. Ensure that the connections with information technology equipment, e.g. PCs or other industrial computers, comply with the IEC 60950-1 / EN 60950-1 or IEC 61010-1 / EN 61010-1 standards that apply in each case.
11. Unless expressly permitted, never remove the cover or any part of the housing while the product is in operation. Doing so will expose circuits and components and can lead to injuries, fire or damage to the product.
12. If a product is to be permanently installed, the connection between the protective conductor terminal on site and the product's protective conductor must be made first before any other connection is made. The product may be installed and connected only by a licensed electrician.
13. For permanently installed equipment without built-in fuses, circuit breakers or similar protective devices, the supply circuit must be fuse-protected in such a way that anyone who has access to the product, as well as the product itself, is adequately protected from injury or damage.
14. Use suitable overvoltage protection to ensure that no overvoltage (such as that caused by a bolt of lightning) can reach the product. Otherwise, the person operating the product will be exposed to the danger of an electric shock.
15. Any object that is not designed to be placed in the openings of the housing must not be used for this purpose. Doing so can cause short circuits inside the product and/or electric shocks, fire or injuries.
16. Unless specified otherwise, products are not liquid-proof (see also section "Operating states and operating positions", item 1). Therefore, the equipment must be protected against penetration by liquids. If the necessary precautions are not taken, the user may suffer electric shock or the product itself may be damaged, which can also lead to personal injury.
17. Never use the product under conditions in which condensation has formed or can form in or on the product, e.g. if the product has been moved from a cold to a warm environment. Penetration by water increases the risk of electric shock.
18. Prior to cleaning the product, disconnect it completely from the power supply (e.g. AC supply network or battery). Use a soft, non-linting cloth to clean the product. Never use chemical cleaning agents such as alcohol, acetone or diluents for cellulose lacquers.

Operation

1. Operating the products requires special training and intense concentration. Make sure that persons who use the products are physically, mentally and emotionally fit enough to do so; otherwise, injuries or material damage may occur. It is the responsibility of the employer/operator to select suitable personnel for operating the products.

Basic Safety Instructions

2. Before you move or transport the product, read and observe the section titled "Transport".
3. As with all industrially manufactured goods, the use of substances that induce an allergic reaction (allergens) such as nickel cannot be generally excluded. If you develop an allergic reaction (such as a skin rash, frequent sneezing, red eyes or respiratory difficulties) when using a Rohde & Schwarz product, consult a physician immediately to determine the cause and to prevent health problems or stress.
4. Before you start processing the product mechanically and/or thermally, or before you take it apart, be sure to read and pay special attention to the section titled "Waste disposal/Environmental protection", item 1.
5. Depending on the function, certain products such as RF radio equipment can produce an elevated level of electromagnetic radiation. Considering that unborn babies require increased protection, pregnant women must be protected by appropriate measures. Persons with pacemakers may also be exposed to risks from electromagnetic radiation. The employer/operator must evaluate workplaces where there is a special risk of exposure to radiation and, if necessary, take measures to avert the potential danger.
6. Should a fire occur, the product may release hazardous substances (gases, fluids, etc.) that can cause health problems. Therefore, suitable measures must be taken, e.g. protective masks and protective clothing must be worn.
7. Laser products are given warning labels that are standardized according to their laser class. Lasers can cause biological harm due to the properties of their radiation and due to their extremely concentrated electromagnetic power. If a laser product (e.g. a CD/DVD drive) is integrated into a Rohde & Schwarz product, absolutely no other settings or functions may be used as described in the product documentation. The objective is to prevent personal injury (e.g. due to laser beams).
8. EMC classes (in line with EN 55011/CISPR 11, and analogously with EN 55022/CISPR 22, EN 55032/CISPR 32)
 - Class A equipment:
Equipment suitable for use in all environments except residential environments and environments that are directly connected to a low-voltage supply network that supplies residential buildings
Note: Class A equipment is intended for use in an industrial environment. This equipment may cause radio disturbances in residential environments, due to possible conducted as well as radiated disturbances. In this case, the operator may be required to take appropriate measures to eliminate these disturbances.
 - Class B equipment:
Equipment suitable for use in residential environments and environments that are directly connected to a low-voltage supply network that supplies residential buildings

Repair and service

1. The product may be opened only by authorized, specially trained personnel. Before any work is performed on the product or before the product is opened, it must be disconnected from the AC supply network. Otherwise, personnel will be exposed to the risk of an electric shock.

Basic Safety Instructions

- Adjustments, replacement of parts, maintenance and repair may be performed only by electrical experts authorized by Rohde & Schwarz. Only original parts may be used for replacing parts relevant to safety (e.g. power switches, power transformers, fuses). A safety test must always be performed after parts relevant to safety have been replaced (visual inspection, protective conductor test, insulation resistance measurement, leakage current measurement, functional test). This helps ensure the continued safety of the product.

Batteries and rechargeable batteries/cells

If the information regarding batteries and rechargeable batteries/cells is not observed either at all or to the extent necessary, product users may be exposed to the risk of explosions, fire and/or serious personal injury, and, in some cases, death. Batteries and rechargeable batteries with alkaline electrolytes (e.g. lithium cells) must be handled in accordance with the EN 62133 standard.

- Cells must not be taken apart or crushed.
- Cells or batteries must not be exposed to heat or fire. Storage in direct sunlight must be avoided. Keep cells and batteries clean and dry. Clean soiled connectors using a dry, clean cloth.
- Cells or batteries must not be short-circuited. Cells or batteries must not be stored in a box or in a drawer where they can short-circuit each other, or where they can be short-circuited by other conductive materials. Cells and batteries must not be removed from their original packaging until they are ready to be used.
- Cells and batteries must not be exposed to any mechanical shocks that are stronger than permitted.
- If a cell develops a leak, the fluid must not be allowed to come into contact with the skin or eyes. If contact occurs, wash the affected area with plenty of water and seek medical aid.
- Improperly replacing or charging cells or batteries that contain alkaline electrolytes (e.g. lithium cells) can cause explosions. Replace cells or batteries only with the matching Rohde & Schwarz type (see parts list) in order to ensure the safety of the product.
- Cells and batteries must be recycled and kept separate from residual waste. Rechargeable batteries and normal batteries that contain lead, mercury or cadmium are hazardous waste. Observe the national regulations regarding waste disposal and recycling.
- Follow the transport stipulations of the carrier (IATA-DGR, IMDG-Code, ADR, RID) when returning lithium batteries to Rohde & Schwarz subsidiaries.

Transport

- The product may be very heavy. Therefore, the product must be handled with care. In some cases, the user may require a suitable means of lifting or moving the product (e.g. with a lift-truck) to avoid back or other physical injuries.
- Handles on the products are designed exclusively to enable personnel to transport the product. It is therefore not permissible to use handles to fasten the product to or on transport equipment such as cranes, fork lifts, wagons, etc. The user is responsible for securely fastening the products to or on the means of transport or lifting. Observe the safety regulations of the manufacturer of the means of transport or lifting. Noncompliance can result in personal injury or material damage.

Instrucciones de seguridad elementales

3. If you use the product in a vehicle, it is the sole responsibility of the driver to drive the vehicle safely and properly. The manufacturer assumes no responsibility for accidents or collisions. Never use the product in a moving vehicle if doing so could distract the driver of the vehicle. Adequately secure the product in the vehicle to prevent injuries or other damage in the event of an accident.

Waste disposal/Environmental protection

1. Specially marked equipment has a battery or accumulator that must not be disposed of with unsorted municipal waste, but must be collected separately. It may only be disposed of at a suitable collection point or via a Rohde & Schwarz customer service center.
2. Waste electrical and electronic equipment must not be disposed of with unsorted municipal waste, but must be collected separately.
Rohde & Schwarz GmbH & Co. KG has developed a disposal concept and takes full responsibility for take-back obligations and disposal obligations for manufacturers within the EU. Contact your Rohde & Schwarz customer service center for environmentally responsible disposal of the product.
3. If products or their components are mechanically and/or thermally processed in a manner that goes beyond their intended use, hazardous substances (heavy-metal dust such as lead, beryllium, nickel) may be released. For this reason, the product may only be disassembled by specially trained personnel. Improper disassembly may be hazardous to your health. National waste disposal regulations must be observed.
4. If handling the product releases hazardous substances or fuels that must be disposed of in a special way, e.g. coolants or engine oils that must be replenished regularly, the safety instructions of the manufacturer of the hazardous substances or fuels and the applicable regional waste disposal regulations must be observed. Also observe the relevant safety instructions in the product documentation. The improper disposal of hazardous substances or fuels can cause health problems and lead to environmental damage.

For additional information about environmental protection, visit the Rohde & Schwarz website.

Instrucciones de seguridad elementales

¡Es imprescindible leer y cumplir las siguientes instrucciones e informaciones de seguridad!

El principio del grupo de empresas Rohde & Schwarz consiste en tener nuestros productos siempre al día con los estándares de seguridad y de ofrecer a nuestros clientes el máximo grado de seguridad. Nuestros productos y todos los equipos adicionales son siempre fabricados y examinados según las normas de seguridad vigentes. Nuestro sistema de garantía de calidad controla constantemente que sean cumplidas estas normas. El presente producto ha sido fabricado y examinado según el certificado de conformidad de la UE y ha salido de nuestra planta en estado impecable según los estándares técnicos de seguridad. Para poder preservar este estado y garantizar un funcionamiento libre de peligros, el usuario deberá atenerse a todas las indicaciones, informaciones de seguridad y notas de alerta. El grupo de empresas Rohde & Schwarz está siempre a su disposición en caso de que tengan preguntas referentes a estas informaciones de seguridad.

Instrucciones de seguridad elementales











Además queda en la responsabilidad del usuario utilizar el producto en la forma debida. Este producto está destinado exclusivamente al uso en la industria y el laboratorio o, si ha sido expresamente autorizado, para aplicaciones de campo y de ninguna manera deberá ser utilizado de modo que alguna persona/cosa pueda sufrir daño. El uso del producto fuera de sus fines definidos o sin tener en cuenta las instrucciones del fabricante queda en la responsabilidad del usuario. El fabricante no se hace en ninguna forma responsable de consecuencias a causa del mal uso del producto.

Se parte del uso correcto del producto para los fines definidos si el producto es utilizado conforme a las indicaciones de la correspondiente documentación del producto y dentro del margen de rendimiento definido (ver hoja de datos, documentación, informaciones de seguridad que siguen). El uso del producto hace necesarios conocimientos técnicos y ciertos conocimientos del idioma inglés. Por eso se debe tener en cuenta que el producto solo pueda ser operado por personal especializado o personas instruidas en profundidad con las capacidades correspondientes. Si fuera necesaria indumentaria de seguridad para el uso de productos de Rohde & Schwarz, encontraría la información debida en la documentación del producto en el capítulo correspondiente. Guarde bien las informaciones de seguridad elementales, así como la documentación del producto, y entréguelas a usuarios posteriores.







Tener en cuenta las informaciones de seguridad sirve para evitar en lo posible lesiones o daños por peligros de toda clase. Por eso es imprescindible leer detalladamente y comprender por completo las siguientes informaciones de seguridad antes de usar el producto, y respetarlas durante el uso del producto. Deberán tenerse en cuenta todas las demás informaciones de seguridad, como p. ej. las referentes a la protección de personas, que encontrarán en el capítulo correspondiente de la documentación del producto y que también son de obligado cumplimiento. En las presentes informaciones de seguridad se recogen todos los objetos que distribuye el grupo de empresas Rohde & Schwarz bajo la denominación de "producto", entre ellos también aparatos, instalaciones así como toda clase de accesorios. Los datos específicos del producto figuran en la hoja de datos y en la documentación del producto.

Señalización de seguridad de los productos

Las siguientes señales de seguridad se utilizan en los productos para advertir sobre riesgos y peligros.

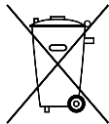
Símbolo	Significado	Símbolo	Significado
	Aviso: punto de peligro general Observar la documentación del producto		Tensión de alimentación de PUESTA EN MARCHA / PARADA
	Atención en el manejo de dispositivos de peso elevado		Indicación de estado de espera (standby)
	Peligro de choque eléctrico		Corriente continua (DC)
	Advertencia: superficie caliente		Corriente alterna (AC)
	Conexión a conductor de protección		Corriente continua / Corriente alterna (DC/AC)

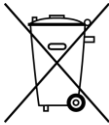
Instrucciones de seguridad elementales

Símbolo	Significado	Símbolo	Significado
	Conexión a tierra		El aparato está protegido en su totalidad por un aislamiento doble (reforzado)
	Conexión a masa		Distintivo de la UE para baterías y acumuladores Más información en la sección "Eliminación/protección del medio ambiente", punto 1.
	Aviso: Cuidado en el manejo de dispositivos sensibles a la electrostática (ESD)		Distintivo de la UE para la eliminación por separado de dispositivos eléctricos y electrónicos Más información en la sección "Eliminación/protección del medio ambiente", punto 2.
	Advertencia: rayo láser Más información en la sección "Funcionamiento", punto 7.		

Palabras de señal y su significado

En la documentación del producto se utilizan las siguientes palabras de señal con el fin de advertir contra riesgos y peligros.



Indica una situación de peligro que, si no se evita, causa lesiones graves o incluso la muerte.



Indica una situación de peligro que, si no se evita, puede causar lesiones graves o incluso la muerte.



Indica una situación de peligro que, si no se evita, puede causar lesiones leves o moderadas.



Indica información que se considera importante, pero no en relación con situaciones de peligro; p. ej., avisos sobre posibles daños materiales.

En la documentación del producto se emplea de forma sinónima el término CUIDADO.

Las palabras de señal corresponden a la definición habitual para aplicaciones civiles en el área económica europea. Pueden existir definiciones diferentes a esta definición en otras áreas económicas o en aplicaciones militares. Por eso se deberá tener en cuenta que las palabras de señal aquí descritas sean utilizadas siempre solamente en combinación con la correspondiente documentación del producto y solamente en combinación con el producto correspondiente. La utilización de las palabras de señal en combinación con productos o documentaciones que no les correspondan puede llevar a interpretaciones equivocadas y tener por consecuencia daños en personas u objetos.

Instrucciones de seguridad elementales

Estados operativos y posiciones de funcionamiento

El producto solamente debe ser utilizado según lo indicado por el fabricante respecto a los estados operativos y posiciones de funcionamiento sin que se obstruya la ventilación. Si no se siguen las indicaciones del fabricante, pueden producirse choques eléctricos, incendios y/o lesiones graves con posible consecuencia de muerte. En todos los trabajos deberán ser tenidas en cuenta las normas nacionales y locales de seguridad del trabajo y de prevención de accidentes.

1. Si no se convino de otra manera, es para los productos Rohde & Schwarz válido lo que sigue: como posición de funcionamiento se define por principio la posición con el suelo de la caja para abajo, modo de protección IP 2X, uso solamente en estancias interiores, utilización hasta 2000 m sobre el nivel del mar, transporte hasta 4500 m sobre el nivel del mar. Se aplicará una tolerancia de $\pm 10\%$ sobre el voltaje nominal y de $\pm 5\%$ sobre la frecuencia nominal. Categoría de sobrecarga eléctrica 2, índice de suciedad 2.
2. No sitúe el producto encima de superficies, vehículos, estantes o mesas, que por sus características de peso o de estabilidad no sean aptos para él. Siga siempre las instrucciones de instalación del fabricante cuando instale y asegure el producto en objetos o estructuras (p. ej. paredes y estantes). Si se realiza la instalación de modo distinto al indicado en la documentación del producto, se pueden causar lesiones o, en determinadas circunstancias, incluso la muerte.
3. No ponga el producto sobre aparatos que generen calor (p. ej. radiadores o calefactores). La temperatura ambiente no debe superar la temperatura máxima especificada en la documentación del producto o en la hoja de datos. En caso de sobrecalentamiento del producto, pueden producirse choques eléctricos, incendios y/o lesiones graves con posible consecuencia de muerte.

Seguridad eléctrica

Si no se siguen (o se siguen de modo insuficiente) las indicaciones del fabricante en cuanto a seguridad eléctrica, pueden producirse choques eléctricos, incendios y/o lesiones graves con posible consecuencia de muerte.

1. Antes de la puesta en marcha del producto se deberá comprobar siempre que la tensión preseleccionada en el producto coincida con la de la red de alimentación eléctrica. Si es necesario modificar el ajuste de tensión, también se deberán cambiar en caso dado los fusibles correspondientes del producto.
2. Los productos de la clase de protección I con alimentación móvil y enchufe individual solamente podrán enchufarse a tomas de corriente con contacto de seguridad y con conductor de protección conectado.
3. Queda prohibida la interrupción intencionada del conductor de protección, tanto en la toma de corriente como en el mismo producto. La interrupción puede tener como consecuencia el riesgo de que el producto sea fuente de choques eléctricos. Si se utilizan cables alargadores o regletas de enchufe, deberá garantizarse la realización de un examen regular de los mismos en cuanto a su estado técnico de seguridad.
4. Si el producto no está equipado con un interruptor para desconectarlo de la red, o bien si el interruptor existente no resulta apropiado para la desconexión de la red, el enchufe del cable de conexión se deberá considerar como un dispositivo de desconexión. El dispositivo de desconexión se debe poder alcanzar fácilmente y debe estar siempre bien accesible. Si, p. ej., el enchufe de conexión a la red es el dispositivo de desconexión, la longitud del cable de conexión no debe superar 3 m).
Los interruptores selectores o electrónicos no son aptos para el corte de la red eléctrica. Si se

Instrucciones de seguridad elementales

integran productos sin interruptor en bastidores o instalaciones, se deberá colocar el interruptor en el nivel de la instalación.

5. No utilice nunca el producto si está dañado el cable de conexión a red. Compruebe regularmente el correcto estado de los cables de conexión a red. Asegúrese, mediante las medidas de protección y de instalación adecuadas, de que el cable de conexión a red no pueda ser dañado o de que nadie pueda ser dañado por él, p. ej. al tropezar o por un choque eléctrico.
6. Solamente está permitido el funcionamiento en redes de alimentación TN/TT aseguradas con fusibles de 16 A como máximo (utilización de fusibles de mayor amperaje solo previa consulta con el grupo de empresas Rohde & Schwarz).
7. Nunca conecte el enchufe en tomas de corriente sucias o llenas de polvo. Introduzca el enchufe por completo y fuertemente en la toma de corriente. La no observación de estas medidas puede provocar chispas, fuego y/o lesiones.
8. No sobrecargue las tomas de corriente, los cables alargadores o las regletas de enchufe ya que esto podría causar fuego o choques eléctricos.
9. En las mediciones en circuitos de corriente con una tensión $U_{\text{eff}} > 30 \text{ V}$ se deberán tomar las medidas apropiadas para impedir cualquier peligro (p. ej. medios de medición adecuados, seguros, limitación de tensión, corte protector, aislamiento etc.).
10. Para la conexión con dispositivos informáticos como un PC o un ordenador industrial, debe comprobarse que éstos cumplan los estándares IEC60950-1/EN60950-1 o IEC61010-1/EN 61010-1 válidos en cada caso.
11. A menos que esté permitido expresamente, no retire nunca la tapa ni componentes de la carcasa mientras el producto esté en servicio. Esto pone a descubierto los cables y componentes eléctricos y puede causar lesiones, fuego o daños en el producto.
12. Si un producto se instala en un lugar fijo, se deberá primero conectar el conductor de protección fijo con el conductor de protección del producto antes de hacer cualquier otra conexión. La instalación y la conexión deberán ser efectuadas por un electricista especializado.
13. En el caso de dispositivos fijos que no estén provistos de fusibles, interruptor automático ni otros mecanismos de seguridad similares, el circuito de alimentación debe estar protegido de modo que todas las personas que puedan acceder al producto, así como el producto mismo, estén a salvo de posibles daños.
14. Todo producto debe estar protegido contra sobretensión (debida p. ej. a una caída del rayo) mediante los correspondientes sistemas de protección. Si no, el personal que lo utilice quedará expuesto al peligro de choque eléctrico.
15. No debe introducirse en los orificios de la caja del aparato ningún objeto que no esté destinado a ello. Esto puede producir cortocircuitos en el producto y/o puede causar choques eléctricos, fuego o lesiones.
16. Salvo indicación contraria, los productos no están impermeabilizados (ver también el capítulo "Estados operativos y posiciones de funcionamiento", punto 1). Por eso es necesario tomar las medidas necesarias para evitar la entrada de líquidos. En caso contrario, existe peligro de choque eléctrico para el usuario o de daños en el producto, que también pueden redundar en peligro para las personas.

Instrucciones de seguridad elementales

17. No utilice el producto en condiciones en las que pueda producirse o ya se hayan producido condensaciones sobre el producto o en el interior de éste, como p. ej. al desplazarlo de un lugar frío a otro caliente. La entrada de agua aumenta el riesgo de choque eléctrico.
18. Antes de la limpieza, desconecte por completo el producto de la alimentación de tensión (p. ej. red de alimentación o batería). Realice la limpieza de los aparatos con un paño suave, que no se deshilache. No utilice bajo ningún concepto productos de limpieza químicos como alcohol, acetona o diluyentes para lacas nitrocelulósicas.

Funcionamiento

1. El uso del producto requiere instrucciones especiales y una alta concentración durante el manejo. Debe asegurarse que las personas que manejen el producto estén a la altura de los requerimientos necesarios en cuanto a aptitudes físicas, psíquicas y emocionales, ya que de otra manera no se pueden excluir lesiones o daños de objetos. El empresario u operador es responsable de seleccionar el personal usuario apto para el manejo del producto.
2. Antes de desplazar o transportar el producto, lea y tenga en cuenta el capítulo "Transporte".
3. Como con todo producto de fabricación industrial no puede quedar excluida en general la posibilidad de que se produzcan alergias provocadas por algunos materiales empleados —los llamados alérgenos (p. ej. el níquel)—. Si durante el manejo de productos Rohde & Schwarz se producen reacciones alérgicas, como p. ej. irritaciones cutáneas, estornudos continuos, enrojecimiento de la conjuntiva o dificultades respiratorias, debe avisarse inmediatamente a un médico para investigar las causas y evitar cualquier molestia o daño a la salud.
4. Antes de la manipulación mecánica y/o térmica o el desmontaje del producto, debe tenerse en cuenta imprescindiblemente el capítulo "Eliminación/protección del medio ambiente", punto 1.
5. Ciertos productos, como p. ej. las instalaciones de radiocomunicación RF, pueden a causa de su función natural, emitir una radiación electromagnética aumentada. Deben tomarse todas las medidas necesarias para la protección de las mujeres embarazadas. También las personas con marcapasos pueden correr peligro a causa de la radiación electromagnética. El empresario/operador tiene la obligación de evaluar y señalar las áreas de trabajo en las que exista un riesgo elevado de exposición a radiaciones.
6. Tenga en cuenta que en caso de incendio pueden desprenderse del producto sustancias tóxicas (gases, líquidos etc.) que pueden generar daños a la salud. Por eso, en caso de incendio deben usarse medidas adecuadas, como p. ej. máscaras antigás e indumentaria de protección.
7. Los productos con láser están provistos de indicaciones de advertencia normalizadas en función de la clase de láser del que se trate. Los rayos láser pueden provocar daños de tipo biológico a causa de las propiedades de su radiación y debido a su concentración extrema de potencia electromagnética. En caso de que un producto Rohde & Schwarz contenga un producto láser (p. ej. un lector de CD/DVD), no debe usarse ninguna otra configuración o función aparte de las descritas en la documentación del producto, a fin de evitar lesiones (p. ej. debidas a irradiación láser).
8. Clases de compatibilidad electromagnética (conforme a EN 55011 / CISPR 11; y en analogía con EN 55022 / CISPR 22, EN 55032 / CISPR 32)
 - Aparato de clase A:
Aparato adecuado para su uso en todos los entornos excepto en los residenciales y en aquellos conectados directamente a una red de distribución de baja tensión que suministra corriente a edificios residenciales.
Nota: Los aparatos de clase A están destinados al uso en entornos industriales. Estos aparatos

Instrucciones de seguridad elementales

pueden causar perturbaciones radioeléctricas en entornos residenciales debido a posibles perturbaciones guiadas o radiadas. En este caso, se le podrá solicitar al operador que tome las medidas adecuadas para eliminar estas perturbaciones.

- Aparato de clase B:
Aparato adecuado para su uso en entornos residenciales, así como en aquellos conectados directamente a una red de distribución de baja tensión que suministra corriente a edificios residenciales.

Reparación y mantenimiento

1. El producto solamente debe ser abierto por personal especializado con autorización para ello. Antes de manipular el producto o abrirlo, es obligatorio desconectarlo de la tensión de alimentación, para evitar toda posibilidad de choque eléctrico.
2. El ajuste, el cambio de partes, el mantenimiento y la reparación deberán ser efectuadas solamente por electricistas autorizados por Rohde & Schwarz. Si se reponen partes con importancia para los aspectos de seguridad (p. ej. el enchufe, los transformadores o los fusibles), solamente podrán ser sustituidos por partes originales. Después de cada cambio de partes relevantes para la seguridad deberá realizarse un control de seguridad (control a primera vista, control del conductor de protección, medición de resistencia de aislamiento, medición de la corriente de fuga, control de funcionamiento). Con esto queda garantizada la seguridad del producto.

Baterías y acumuladores o celdas

Si no se siguen (o se siguen de modo insuficiente) las indicaciones en cuanto a las baterías y acumuladores o celdas, pueden producirse explosiones, incendios y/o lesiones graves con posible consecuencia de muerte. El manejo de baterías y acumuladores con electrolitos alcalinos (p. ej. celdas de litio) debe seguir el estándar EN 62133.

1. No deben desmontarse, abrirse ni triturarse las celdas.
2. Las celdas o baterías no deben someterse a calor ni fuego. Debe evitarse el almacenamiento a la luz directa del sol. Las celdas y baterías deben mantenerse limpias y secas. Limpiar las conexiones sucias con un paño seco y limpio.
3. Las celdas o baterías no deben cortocircuitarse. Es peligroso almacenar las celdas o baterías en estuches o cajones en cuyo interior puedan cortocircuitarse por contacto recíproco o por contacto con otros materiales conductores. No deben extraerse las celdas o baterías de sus embalajes originales hasta el momento en que vayan a utilizarse.
4. Las celdas o baterías no deben someterse a impactos mecánicos fuertes indebidos.
5. En caso de falta de estanqueidad de una celda, el líquido vertido no debe entrar en contacto con la piel ni los ojos. Si se produce contacto, lavar con agua abundante la zona afectada y avisar a un médico.
6. En caso de cambio o recarga inadecuados, las celdas o baterías que contienen electrolitos alcalinos (p. ej. las celdas de litio) pueden explotar. Para garantizar la seguridad del producto, las celdas o baterías solo deben ser sustituidas por el tipo Rohde & Schwarz correspondiente (ver lista de recambios).
7. Las baterías y celdas deben reciclarse y no deben tirarse a la basura doméstica. Las baterías o acumuladores que contienen plomo, mercurio o cadmio deben tratarse como residuos especiales. Respete en esta relación las normas nacionales de eliminación y reciclaje.

Instrucciones de seguridad elementales

8. En caso de devolver baterías de litio a las filiales de Rohde & Schwarz, debe cumplirse las normativas sobre los modos de transporte (IATA-DGR, código IMDG, ADR, RID).

Transporte

1. El producto puede tener un peso elevado. Por eso es necesario desplazarlo o transportarlo con precaución y, si es necesario, usando un sistema de elevación adecuado (p. ej. una carretilla elevadora), a fin de evitar lesiones en la espalda u otros daños personales.
2. Las asas instaladas en los productos sirven solamente de ayuda para el transporte del producto por personas. Por eso no está permitido utilizar las asas para la sujeción en o sobre medios de transporte como p. ej. grúas, carretillas elevadoras de horquilla, carros etc. Es responsabilidad suya fijar los productos de manera segura a los medios de transporte o elevación. Para evitar daños personales o daños en el producto, siga las instrucciones de seguridad del fabricante del medio de transporte o elevación utilizado.
3. Si se utiliza el producto dentro de un vehículo, recae de manera exclusiva en el conductor la responsabilidad de conducir el vehículo de manera segura y adecuada. El fabricante no asumirá ninguna responsabilidad por accidentes o colisiones. No utilice nunca el producto dentro de un vehículo en movimiento si esto pudiera distraer al conductor. Asegure el producto dentro del vehículo debidamente para evitar, en caso de un accidente, lesiones u otra clase de daños.

Eliminación/protección del medio ambiente

1. Los dispositivos marcados contienen una batería o un acumulador que no se debe desechar con los residuos domésticos sin clasificar, sino que debe ser recogido por separado. La eliminación se debe efectuar exclusivamente a través de un punto de recogida apropiado o del servicio de atención al cliente de Rohde & Schwarz.
2. Los dispositivos eléctricos usados no se deben desechar con los residuos domésticos sin clasificar, sino que deben ser recogidos por separado.
Rohde & Schwarz GmbH & Co.KG ha elaborado un concepto de eliminación de residuos y asume plenamente los deberes de recogida y eliminación para los fabricantes dentro de la UE. Para desechar el producto de manera respetuosa con el medio ambiente, diríjase a su servicio de atención al cliente de Rohde & Schwarz.
3. Si se trabaja de manera mecánica y/o térmica cualquier producto o componente más allá del funcionamiento previsto, pueden liberarse sustancias peligrosas (polvos con contenido de metales pesados como p. ej. plomo, berilio o níquel). Por eso el producto solo debe ser desmontado por personal especializado con formación adecuada. Un desmontaje inadecuado puede ocasionar daños para la salud. Se deben tener en cuenta las directivas nacionales referentes a la eliminación de residuos.
4. En caso de que durante el trato del producto se formen sustancias peligrosas o combustibles que deban tratarse como residuos especiales (p. ej. refrigerantes o aceites de motor con intervalos de cambio definidos), deben tenerse en cuenta las indicaciones de seguridad del fabricante de dichas sustancias y las normas regionales de eliminación de residuos. Tenga en cuenta también en caso necesario las indicaciones de seguridad especiales contenidas en la documentación del producto. La eliminación incorrecta de sustancias peligrosas o combustibles puede causar daños a la salud o daños al medio ambiente.

Se puede encontrar más información sobre la protección del medio ambiente en la página web de Rohde & Schwarz.

Customer Support

Technical support – where and when you need it

For quick, expert help with any Rohde & Schwarz equipment, contact one of our Customer Support Centers. A team of highly qualified engineers provides telephone support and will work with you to find a solution to your query on any aspect of the operation, programming or applications of Rohde & Schwarz equipment.

Up-to-date information and upgrades

To keep your instrument up-to-date and to be informed about new application notes related to your instrument, please send an e-mail to the Customer Support Center stating your instrument and your wish. We will take care that you will get the right information.

Europe, Africa, Middle East

Phone +49 89 4129 12345
customersupport@rohde-schwarz.com

North America

Phone 1-888-TEST-RSA (1-888-837-8772)
customer.support@rsa.rohde-schwarz.com

Latin America

Phone +1-410-910-7988
customersupport.la@rohde-schwarz.com

Asia/Pacific

Phone +65 65 13 04 88
customersupport.asia@rohde-schwarz.com

China

Phone +86-800-810-8228 /
+86-400-650-5896
customersupport.china@rohde-schwarz.com



Contents

1	Documentation Overview.....	5
1.1	Getting Started Manual.....	5
1.2	User Manuals.....	5
1.3	Tutorials.....	5
1.4	Instrument Security Procedures.....	5
1.5	Basic Safety Instructions.....	5
1.6	Data Sheets and Brochures.....	6
1.7	Release Notes and Open Source Acknowledgment (OSA).....	6
1.8	Application Notes, Application Cards, White Papers, etc.....	6
2	For Your Safety.....	7
3	Key Features.....	8
4	Preparing for Use.....	10
4.1	EMI Suppression.....	10
4.2	Unpacking and Checking the Power Sensor.....	11
4.3	Connectors of the R&S NRP-Z Power Sensors.....	11
4.4	Connecting the R&S NRP-Z Power Sensors.....	12
4.5	Disconnecting the R&S NRP-Z Power Sensors.....	14
4.6	Powering the R&S NRP-Z Power Sensors.....	15
5	Connecting to a PC.....	16
5.1	Using a Passive USB Adapter.....	16
5.2	Using an Active USB Adapter.....	17
5.3	Using an R&S NRP-Z5 Sensor Hub.....	18
6	Operating Concepts.....	21
6.1	R&S NRP Toolkit.....	21
6.2	R&S NRPV.....	26
6.3	R&S Power Viewer Plus.....	28
6.4	Android Device.....	28
6.5	R&S NRP2.....	30

6.6	Compatible Instrument.....	32
7	Remote Control.....	34
	Index.....	35

1 Documentation Overview

This section provides an overview of the R&S NRP-Z power sensor user documentation. Unless specified otherwise, you find the documents on the R&S NRP-Z power sensor product page at:

www.rohde-schwarz.com/product/nrpz

1.1 Getting Started Manual

Introduces the R&S NRP-Z power sensor and describes how to set up and start working with the product. Includes basic operations and general information, e.g. safety instructions, etc. A printed version is delivered with the power sensor.

1.2 User Manuals

Contains the description of all instrument modes and functions. It also provides an introduction to remote control, a complete description of the remote control commands with programming examples, and information on maintenance and interfaces. Includes the contents of the getting started manual.

1.3 Tutorials

Tutorials offer guided examples and demonstrations on operating the R&S NRP-Z power sensor. They are provided on the product page of the internet.

1.4 Instrument Security Procedures

Deals with security issues when working with the R&S NRP-Z power sensor in secure areas. It is available for download on the Internet.

1.5 Basic Safety Instructions

Contains safety instructions, operating conditions and further important information. The printed document is delivered with the instrument.

1.6 Data Sheets and Brochures

The data sheet contains the technical specifications of the R&S NRP-Z power sensor. It also lists the firmware applications and their order numbers, and optional accessories.

The brochure provides an overview of the instrument and deals with the specific characteristics.

See www.rohde-schwarz.com/brochure-datasheet/nrpz

1.7 Release Notes and Open Source Acknowledgment (OSA)

The release notes list new features, improvements and known issues of the current firmware version, and describe the firmware installation.

The open source acknowledgment document provides verbatim license texts of the used open source software.

See www.rohde-schwarz.com/firmware/nrpz

1.8 Application Notes, Application Cards, White Papers, etc.

These documents deal with special applications or background information on particular topics.

See www.rohde-schwarz.com/application/nrpz

2 For Your Safety

The R&S NRP-Z power sensor is designated for use in industrial, administrative, and laboratory environments. Use the R&S NRP-Z power sensor only for its designated purpose. Observe the safety and usage instructions documented in the user manual, as well as operating conditions and performance limits stated in the data sheet.

The product documentation helps you to use the R&S NRP-Z power sensor safely and efficiently. Keep the product documentation in a safe place and pass it on to the subsequent users.

Safety information is part of the product documentation. It warns you about the potential dangers and gives instructions how to prevent personal injury or damage caused by dangerous situations. Safety information is provided as follows:

- In the "Basic Safety Instructions", safety issues are grouped according to subjects. For example, one subject is electrical safety. The "Basic Safety Instructions" are delivered with the R&S NRP-Z power sensor in different languages in print.
- Throughout the documentation, safety instructions are provided when you need to take care during setup or operation. Always read the safety instructions carefully. Make sure to comply fully with them. Do not take risks and do not underestimate the potential danger of small details such as a damaged power cable.

3 Key Features

Power measurements performed with the R&S NRP-Z power sensors can be evaluated in various ways. This manual gives a short introduction to the solutions offered by Rohde & Schwarz for viewing your power measurement results. Also, you find a description of how to set up and measure power with your power sensor.

You can view the results of your measurement on the following devices:

- PC/laptop
- Android 4.x device
- R&S NRP2 base unit
- Supported Rohde & Schwarz instrument

Using the R&S NRP-Z power sensors with a PC/laptop

Install the R&S NRP Toolkit on the PC/laptop. The R&S NRP Toolkit is a free software kit that provides drivers and tools. For details, see [Chapter 6.1, "R&S NRP Toolkit"](#), on page 21:

For optional use, different software solutions are offered:

- R&S Power Viewer Plus
Free software that supports all measurement modes and can perform mathematical calculations during measurements. It can be used with one power sensor at a time.
For details, see [Chapter 6.3, "R&S Power Viewer Plus"](#), on page 28.
- R&S NRPV virtual power meter
Cost-effective measurement solution that can be used as a replacement for the R&S NRP2 base unit. It supports all measurement modes and can perform different mathematical calculations during measurements. It can be used with up to four power sensors simultaneously.
For details, see [Chapter 6.2, "R&S NRPV"](#), on page 26.

Using the R&S NRP-Z power sensors with an Android device

Also, you can connect the power sensors to an Android device and view the results with the free of charge R&S Power Viewer Mobile app.

For details, see [Chapter 6.4, "Android Device"](#), on page 28.

Using the R&S NRP-Z power sensors with an R&S NRP2 or a compatible Rohde & Schwarz instrument

A short overview of the usage of the power sensors with the R&S NRP2 base unit or a compatible Rohde & Schwarz instrument is given in this manual:

- [Chapter 6.5, "R&S NRP2"](#), on page 30
- [Chapter 6.6, "Compatible Instrument"](#), on page 32

For more information on this usage, refer to the operating manual of the corresponding Rohde & Schwarz instrument.

Overview of the R&S NRP-Z power sensor types

The R&S NRP-Z power sensors are highly accurate standalone measuring instruments that offer all the functionality of conventional power meters, and more, within the small housing of a power sensor. With a high dynamic range, the different types of R&S NRP-Z power sensors are suitable for nearly every measurement task:

- **Three-path power sensors**
With patented three-path technology. Suitable for many applications, thanks to their wide dynamic and frequency range. The sensors feature high measurement accuracy independent of the modulation type and speed and offer a wide range of functions.
- **Two-path power sensors**
With slightly modified dynamic range and performance. A cost-effective solution ideal for production applications.
- **Wideband power sensors**
With high video bandwidth that permits accurate time-domain analysis of the envelope power. Analysis is fast and easy thanks to also integrated measurement functions such as automatic pulse analysis.
- **Thermal power sensors**
With outstanding measurement accuracy. They are the first choice for power measurements in the frequency range from DC to 110 GHz as performed in calibration labs, where measurement accuracy is the key requirement.
- **Average power sensors**
Specially developed for EMC applications and cover the required frequency range from 9 kHz to 6 GHz.
- **Level control sensors**
With an integrated splitter that can split the signal into two parts of equal power. This feature allows you to feed power to a device under test (DUT) and monitor the power at the same time.
- **Power sensor modules**
Developed for level calibration using the R&S FSMR measuring receiver.

You can find an overview of the available sensors and filter according to your requirements at:

www.rohde-schwarz.com/product/nrpz

4 Preparing for Use

This section describes the basic steps to be taken when setting up the R&S NRP-Z power sensors for the first time.

⚠ WARNING

Risk of injury due to disregarding safety information

Observe the information on appropriate operating conditions provided in the data sheet to prevent personal injury or damage to the power sensor. Read and observe the basic safety instructions provided with the power sensor, in addition to the safety instructions in the following sections. In particular, do not open the casing of the power sensor.

NOTICE

Risk of electrostatic discharge

Protect the work area against electrostatic discharge to avoid damage to electronic components in the modules. For details, refer to the general safety instructions.

NOTICE

Risk of instrument damage due to inappropriate operating conditions

An unsuitable operating site or test setup can damage the power sensor and to connected devices. Before switching on the power sensor, observe the information on appropriate operating conditions provided in the data sheet. In particular, ensure the following:

- The power sensor is dry and shows no sign of condensation.
- The power sensor is connected as described in the following sections.
- The ambient temperature does not exceed the range specified in the data sheet.
- Signal levels at the input connectors are all within the specified ranges.
- Signal outputs are correctly connected and are not overloaded.

4.1 EMI Suppression

Electromagnetic interference (EMI) can affect the measurement results.

To suppress generated electromagnetic interference:

- Use suitable shielded cables of high quality. For example, use double-shielded RF cables.
- Always terminate open cable ends.
- Note the EMC classification in the data sheet.

4.2 Unpacking and Checking the Power Sensor

Check the equipment for completeness using the delivery note and the accessory lists for the various items. Check the power sensor for any damage. If there is damage, immediately contact the carrier who delivered the instrument. Make sure not to discard the box and packing material.



Packing material and transportation

Always make sure that sufficient mechanical and electrostatic protection is provided when transporting the power sensors.

4.3 Connectors of the R&S NRP-Z Power Sensors

An R&S NRP-Z power sensor has two connectors, as shown in [Figure 4-1](#).



Figure 4-1: Connectors of an R&S NRP-Z power sensor

- 1 = Host connector
- 2 = RF connector

Host connector

See (1) in [Figure 4-1](#).

Lemo type host connector. You can plug it:

- Directly to a compatible Rohde & Schwarz instrument
- To a R&S NRP2 power meter base unit
- Using an R&S NRP-Z3 or R&S NRP-Z4 USB adapter to a controlling device (PC or other)
- Using an R&S NRP-Z5 USB hub to a controlling device (PC or other)

RF connector

See (2) in [Figure 4-1](#).

Used to connect the power sensor to a device under test (DUT) or a signal generator.

Caused by their different frequency ranges, the R&S NRP-Z power sensors have different RF connectors. Also, for maximal measurement accuracy, the RF connector must be tightened using a torque wrench with a specific nominal torque.

Refer to the operating manual of your R&S NRP-Z power sensor for information on your connector and the allowed nominal torque.

4.4 Connecting the R&S NRP-Z Power Sensors



When connecting the R&S NRP-Z27/-Z28/-Z37/-Z98 sensors, there are additional requirements to fulfill. Refer to the operating manual of the corresponding sensor for a description on how to connect it.

4.4.1 Connecting the RF Connector of the R&S NRP-Z Power Sensors

NOTICE**Risk of damage to the center pin of the RF connector**

When connecting the power sensor, always rotate only the union nut of the RF connector. Do not rotate the sensor itself to avoid damage the center pin of the connector.

1. Refer to the operating manual of your R&S NRP-Z power sensor to find out what kind of RF connector your sensor has and the recommended nominal torque.
2. Insert the RF connector of the attenuator straight into the RF output of your DUT. Do not tilt it.

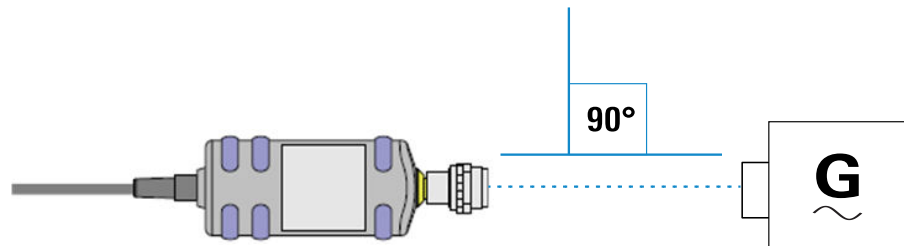

3. To ensure a maximal measurement accuracy, tighten the RF connector using a torque wrench with the recommended nominal torque (see the operating manual of your power sensor).

4.4.2 Connecting the Host Connector of the R&S NRP-Z Power Sensors

To connect to an adapter

You can use an R&S NRP-Z3 or R&S NRP-Z4 adapter.

1. Rotate both cables, so that the red markings on the sleeves of both of them are at the same position.
2. Insert the host connector of your sensor into the connector of your USB adapter.

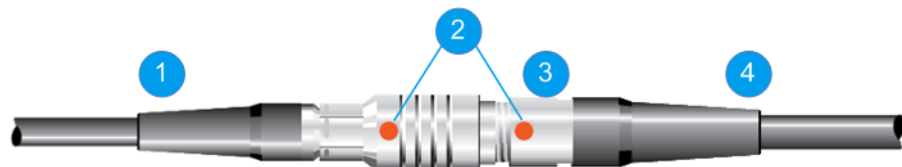

Figure 4-2: Connecting the host connector

- 1 = R&S NRP-Z4 in this example
- 2 = Red marking
- 3 = Host connector
- 4 = R&S NRP-Z power sensor

To connect to an R&S NRP-Z5 sensor hub

- ▶ Insert the host connector, red marking upwards, into the SENSOR connector of your sensor hub.

To connect to an Rohde & Schwarz instrument

- ▶ Insert the host connector, red marking upwards, into the SENSOR connector of your instrument.

4.5 Disconnecting the R&S NRP-Z Power Sensors



Additional requirements must be fulfilled when disconnecting the R&S NRP-Z27/-Z28/-Z37/-Z98 sensors. Refer to the operating manual of the corresponding sensor for a description on how to disconnect it.

4.5.1 Disconnecting the RF Connector of the R&S NRP-Z Power Sensors

NOTICE

Risk of damage to the center pin of the RF connector

When disconnecting the power sensor, always rotate only the union nut of the RF connector. Do not rotate the sensor itself to avoid damage the center pin of the connector.

- ▶ Carefully loosen the screw at the front of the sensor's RF connector and remove the sensor.

4.5.2 Disconnecting the Host Connector of the R&S NRP-Z Power Sensors

To disconnect from an R&S NRP-Z3 or R&S NRP-Z4 adapter

- ▶ Pull at the host connector (Figure 4-2 (3)) until it disconnects from the connector of the USB adapter.

To disconnect from an Rohde & Schwarz instrument or an R&S NRP-Z5 sensor hub

- ▶ At the same time, press down the ring of the built-in plug (1) and pull off the cable sleeve (2).

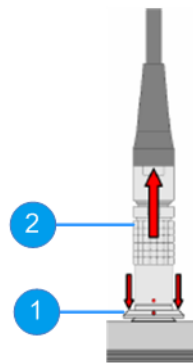

Figure 4-3: Disconnecting from a SENSOR connector

- 1 = Ring of the built-in plug
- 2 = Cable sleeve

4.6 Powering the R&S NRP-Z Power Sensors

The R&S NRP-Z power sensors can be powered in two ways:

- Self-powered from a separate power supply using the R&S NRP-Z3 active USB adapter or the R&S NRP-Z5 sensor hub.
- Bus-powered from the PC or a USB hub with its own power supply (self-powered hub) using the R&S NRP-Z3 active USB adapter or the R&S NRP-Z4 passive USB adapter.

Requirements for the usage in the bus-powered mode:

- Laptop/PC with a self-powered USB hub
- Total available current per USB port of 500 mA

5 Connecting to a PC

There are different possibilities for connecting a power sensor to a PC, which can differ depending on the type of power sensor and available accessories.

The following chapter gives an overview of the possible setups and what equipment is needed for each of them.

For details on powering the R&S NRP-Z power sensor, see [Chapter 4.6, "Powering the R&S NRP-Z Power Sensors"](#), on page 15.

5.1 Using a Passive USB Adapter

The R&S NRP-Z power sensors can be used with the R&S NRP-Z4 for power measurements where no external triggering is required.

Required equipment

- R&S NRP-Z power sensor
- R&S NRP-Z4 passive USB adapter
- PC with installed R&S NRP Toolkit, see [Chapter 6.1, "R&S NRP Toolkit"](#), on page 21

Setup

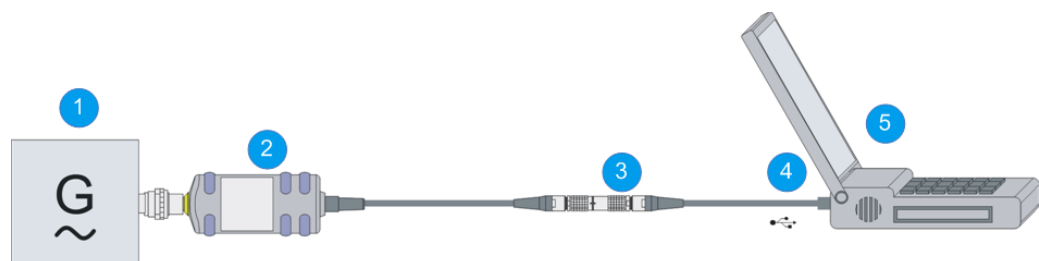

Figure 5-1: Setup with a passive USB adapter

- 1 = Signal source
- 2 = R&S NRP-Z power sensor
- 3 = R&S NRP-Z4
- 4 = USB connector
- 5 = PC with a USB interface



Incorrectly connecting/disconnecting the R&S NRP-Z power sensors may damage the power sensors or lead to erroneous results.

Ensure that you connect/disconnect your power sensors as described in [Chapter 4.4, "Connecting the R&S NRP-Z Power Sensors"](#), on page 12 and [Chapter 4.5, "Disconnecting the R&S NRP-Z Power Sensors"](#), on page 14.

1. Connect the cables as shown in [Figure 5-1](#):

- a) Connect the R&S NRP-Z4 passive USB adapter to the power sensor.
 - b) Connect the power sensor passive USB adapter to the computer.
 - c) Connect the power sensor to the signal source.
2. On the PC, start a software application to view the measurement results. See [Chapter 6, "Operating Concepts"](#), on page 21.

5.2 Using an Active USB Adapter

The R&S NRP-Z power sensors can be used with the R&S NRP-Z3 for power measurements where an external power supply and/or external triggering is required.

Required equipment

- R&S NRP-Z power sensor
- R&S NRP-Z3
- PC with installed R&S NRP Toolkit, see [Chapter 6.1, "R&S NRP Toolkit"](#), on page 21

Setup

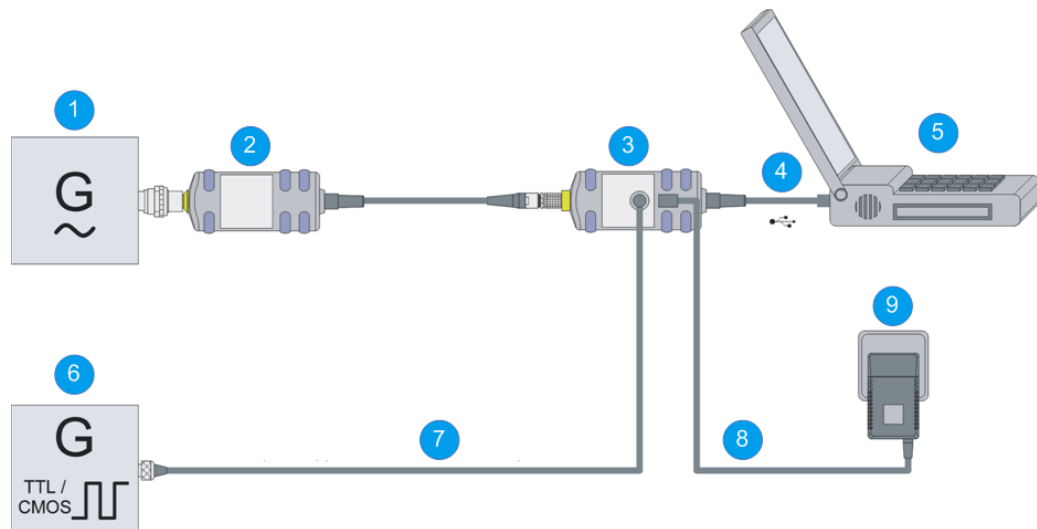

Figure 5-2: Setup with an active USB adapter

- 1 = Signal source
- 2 = R&S NRP-Z power sensor
- 3 = R&S NRP-Z3
- 4 = USB connector
- 5 = PC with a USB interface
- 6 = Trigger source (optional)
- 7 = BNC cable (optional, not supplied)
- 8 = Plug-in power supply (optional, supplied)
- 9 = AC supply connector (optional)



Incorrectly connecting/disconnecting the R&S NRP-Z power sensors may damage the power sensors or lead to erroneous results.

Ensure that you connect/disconnect your power sensors as described in [Chapter 4.4, "Connecting the R&S NRP-Z Power Sensors"](#), on page 12 and [Chapter 4.5, "Disconnecting the R&S NRP-Z Power Sensors"](#), on page 14.

1. Connect the cables as shown in [Figure 5-2](#):
 - a) Connect the R&S NRP-Z3 active USB adapter to the power sensor.
 - b) Connect the power sensor passive USB adapter to the computer.
 - c) Connect the power sensor to the signal source.
 - d) Connect the R&S NRP-Z3 with a BNC cable to the trigger source (optional).
 - e) Connect the delivered plug-in power supply to the R&S NRP-Z3 and to an AC supply connector (optional).
2. On the PC, start a software application to view the measurement results. See [Chapter 6, "Operating Concepts"](#), on page 21.

5.3 Using an R&S NRP-Z5 Sensor Hub

The R&S NRP-Z5 sensor hub (high-speed USB 2.0) can host up to four R&S NRP-Z power sensors and provides simultaneous internal and external triggering of all connected sensors.

Required equipment

- R&S NRP-Z power sensor
- R&S NRP-Z5 sensor hub that provides:
 - Power supply
 - Through-wired trigger bus
 - Trigger input and trigger output via BNC sockets
- PC with installed R&S NRP Toolkit, see [Chapter 6.1, "R&S NRP Toolkit"](#), on page 21

Using an R&S NRP-Z5 Sensor Hub

Setup

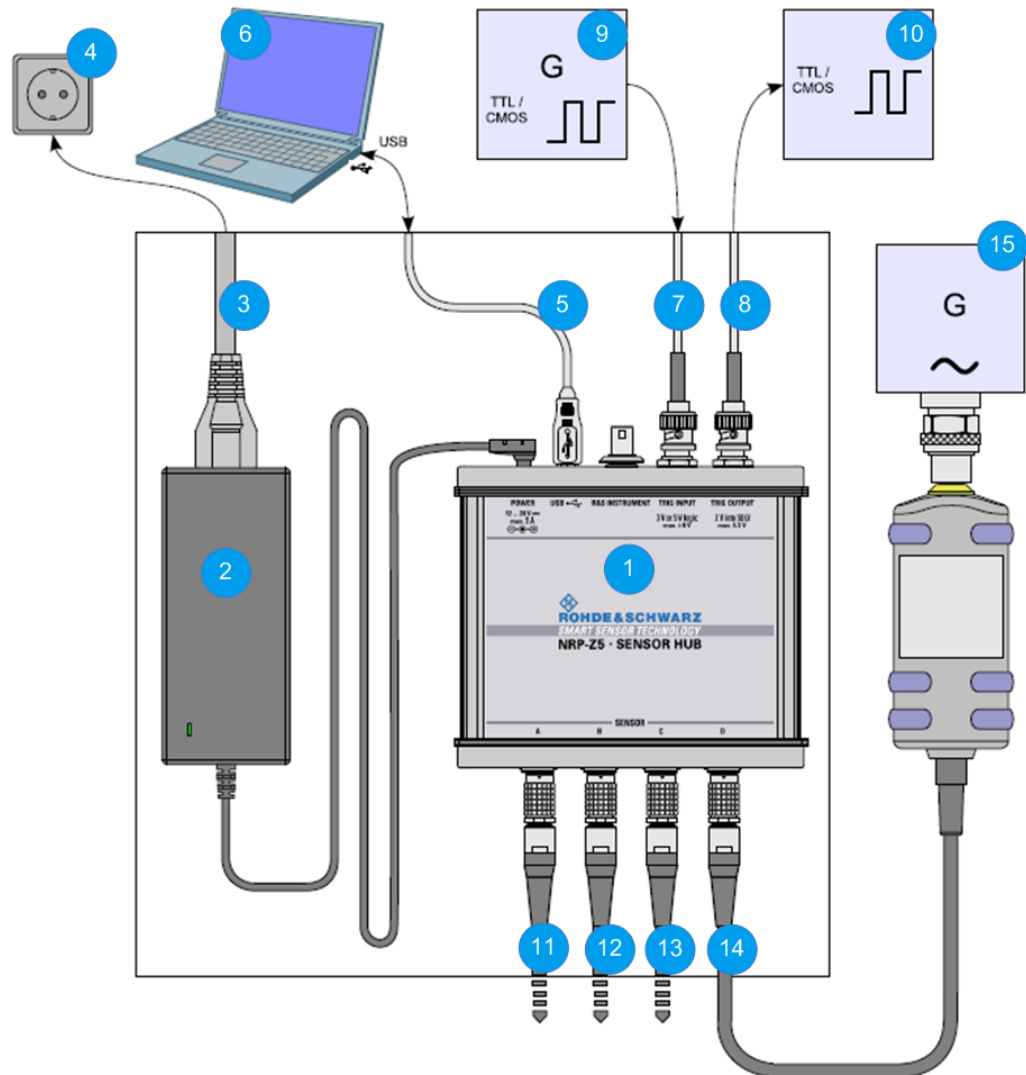

Figure 5-3: Setup with an R&S NRP-Z5 sensor hub

- 1 = R&S NRP-Z5 sensor hub
- 2 = External power supply unit (supplied)
- 3 = Power cable (supplied)
- 4 = AC power supply
- 5 = USB cable (supplied)
- 6 = PC with USB host interface
- 7, 8 = BNC cable (optional, not supplied)
- 9 = Trigger source (optional)
- 10 = Triggered device (optional)
- 11-14 = R&S NRP-Z power sensor
- 15 = Signal source



Incorrectly connecting/disconnecting the R&S NRP-Z power sensors may damage the power sensors or lead to erroneous results.

Ensure that you connect/disconnect your power sensors as described in [Chapter 4.4, "Connecting the R&S NRP-Z Power Sensors"](#), on page 12 and [Chapter 4.5, "Disconnecting the R&S NRP-Z Power Sensors"](#), on page 14.

1. Connect the cables as shown in [Figure 5-3](#):
 - a) Connect the power sensors to the R&S NRP-Z5 sensor hub. You can connect up to four sensors.
 - b) Connect the R&S NRP-Z5 to the computer.
 - c) Connect the power sensors to the signal source.
 - d) Connect the delivered external power supply unit to the R&S NRP-Z5 and to an AC supply connector.
 - e) Connect the R&S NRP-Z5 with a BNC cable to the trigger source (optional).
 - f) Connect the R&S NRP-Z5 with a BNC cable to the trigger device (optional).
2. On the PC, start a software application to view the measurement results. See [Chapter 6, "Operating Concepts"](#), on page 21.

6 Operating Concepts

For operating the power sensor, you can choose from various possibilities.

Alternative to the methods of access described in this chapter, you can use remote control. For details, see:

- [Chapter 7, "Remote Control"](#), on page 34
- Operating manual of the R&S NRP-Z power sensor
- [R&S NRP Toolkit](#).....21
- [R&S NRPV](#).....26
- [R&S Power Viewer Plus](#).....28
- [Android Device](#).....28
- [R&S NRP2](#).....30
- [Compatible Instrument](#).....32

6.1 R&S NRP Toolkit



Before you start using the power sensors with a software solution, you have to install the R&S NRP Toolkit.

The R&S NRP Toolkit is the basic software package that supplies low-level drivers and tools for all power sensors. It is provided on your documentation CD-ROM and on the Rohde & Schwarz website. The content of the toolkit depends on your operating system.



To ensure that your power sensor is recognized properly by your system, first install the R&S NRP Toolkit on your laptop/PC and then connect your power sensor for the first time.

6.1.1 System Requirements

Hardware requirements:

- Desktop PC or laptop, or an Intel-based Apple Mac
- Keyboard and optionally mouse
- USB interface
- R&S NRP-Z3 or R&S NRP-Z4 USB adapter or R&S NRP-Z5 sensor hub

Supported operating systems:

- Microsoft Windows Vista 32/64-bit
- Microsoft Windows 7 32/64-bit
- Microsoft Windows 8 32/64-bit

- Microsoft Windows 10 32/64-bit
- Microsoft Windows XP 32-bit is available on request only.

R&S NRP Toolkit versions for Linux distributions and MacOSX are also available on request. To obtain an R&S NRP Toolkit for an operating system other than Microsoft Windows, contact the Rohde & Schwarz customer support:

customersupport@rohde-schwarz.com

6.1.2 Installing the R&S NRP Toolkit on a Windows PC

The R&S NRP Toolkit installer version for Windows-based systems contains the following components. Obligatory components are indicated.

- USB driver (obligatory)
- `NrpControl2.dll` dynamic link library (obligatory)
- R&S NRP Toolkit (obligatory)
- R&S NRP Toolkit SDK
- S-Parameter tool
Program modules for loading an S-parameter table into the power sensor
- R&S NRP-Z uncertainty calculator and its PDF manual
- Vxl plug&play with programming examples
For installation, enable "NRP-Toolkit-SDK" during the installation of the R&S NRP Toolkit.
- Terminal (`nrpTerm`): low-level communication program for sending commands to the power sensor
- Firmware update (PureFW)
- Nrp Version Collector
Tool for displaying version information of all installed, power measurement-relevant software packages.

To install the R&S NRP Toolkit on a Windows PC

1. Start the R&S NRP Toolkit installer.
2. In the "Choose Components" dialog, select the components you want to install and accept the license terms to continue with the installation

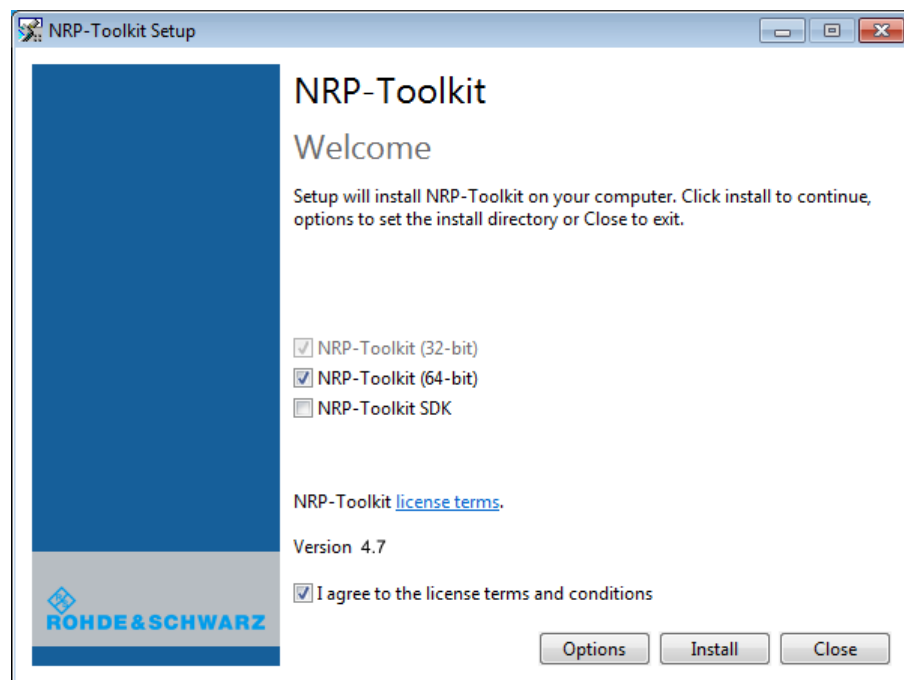

3. Click "Next" and complete the installation process.

6.1.3 Installing the R&S NRP Toolkit on a Linux-Based System

The R&S NRP Toolkit for a certain Linux distribution comes as a series of Debian (*.deb) or RPM (*.rpm) files. These files become installed through the standard installation process of the individual Linux distribution. See the `ReadMe` file that accompanies the R&S NRP Toolkit for further instructions.

6.1.4 Installing the R&S NRP Toolkit on a Mac OS X

The R&S NRP Toolkit installer version for Mac OS X contains the following components:

- Low-level driver: `RsNrpLib.framework`
- VXI PnP driver: `RsNrpz.framework`
- HTML help files for the VXI PnP driver
- Power Viewer Plus and its PDF manual
- Example programs for use with VXI PnP driver

To install the R&S NRP Toolkit on a Mac OS X

1. In the Mac OS X Finder, double-click the provided .dmg disk image to mount it.
2. Double-click the `NrpToolkit.mpkg` installer to start the installation.

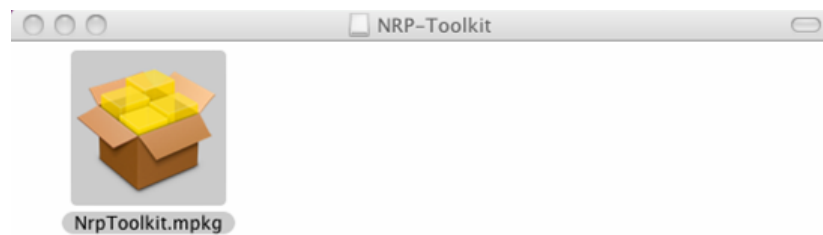

The R&S NRP Toolkit installer opens. The welcome message gives an overview of the packages that are part of the installer and indicates their default installation location.

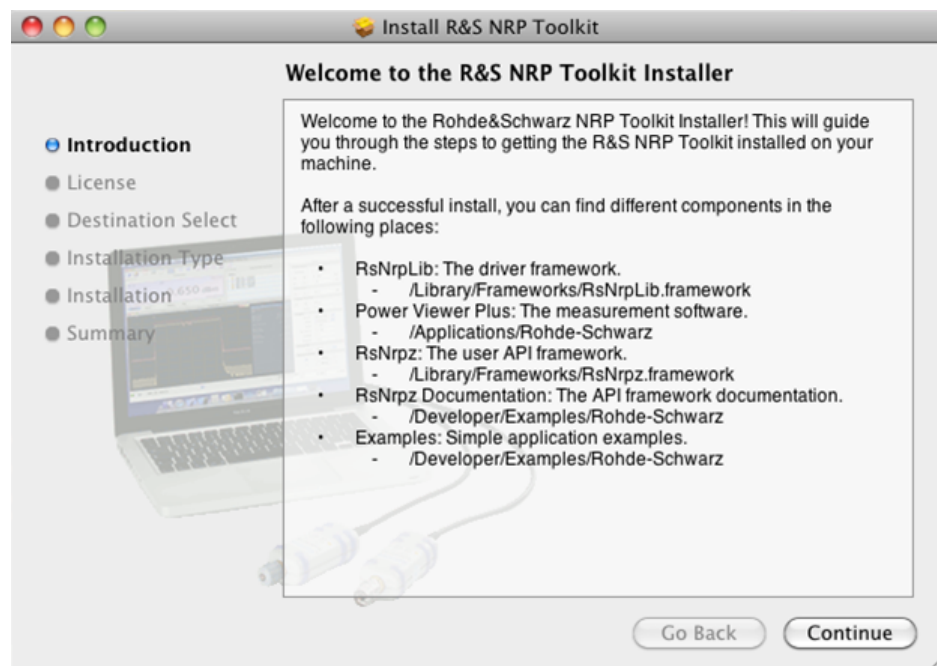

3. Accept the license terms to continue with the installation.
4. Select the components you want to install and click "Continue" to complete the installation process.

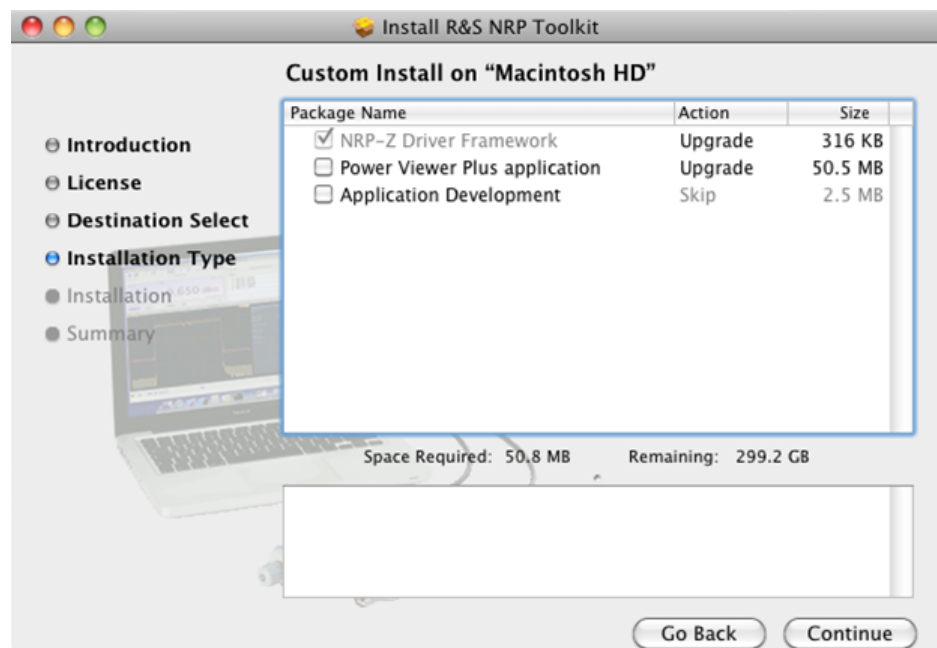

- a) R&S NRP-Z Driver Framework (obligatory).
 - b) Enable the "Power Viewer Plus application" (optional).
 - c) Enable "Application Development" (optional). You can use these examples as starting points for your own implementations.
5. Click "Continue" and complete the installation process.

After a successful installation, you can start the applications provided with the R&S NRP Toolkit from the Rohde-Schwarz folder that was created in the Mac OS X application directory.



6.1.5 Performing a Firmware Update

Use the firmware update program (PureFW) to load new firmware for the power sensors. It is part of the R&S NRP Toolkit that is supplied on a CD-ROM together with the power sensors. For further details, refer to the operating manual.

6.2 R&S NRPV

The R&S NRPV enables you to measure power in all available measurement modes. Also, you can use up to four power sensors simultaneously.

The R&S NRPV software can be installed on any Windows PC. To make full use of its functionalities, you must activate your R&S NRP-Z power sensor with a license key.

Required equipment

- R&S NRP-Z power sensor
- R&S NRP-Z3, R&S NRP-Z4 or R&S NRP-Z5
- Windows PC with installed:
 - R&S NRP Toolkit
 - R&S NRPV (refer to the operating manual of the R&S NRPV for a description of the installation process)
- License key (R&S NRPZ-K1 option) for activating the power measurements for your R&S NRP-Z power sensor

Setup

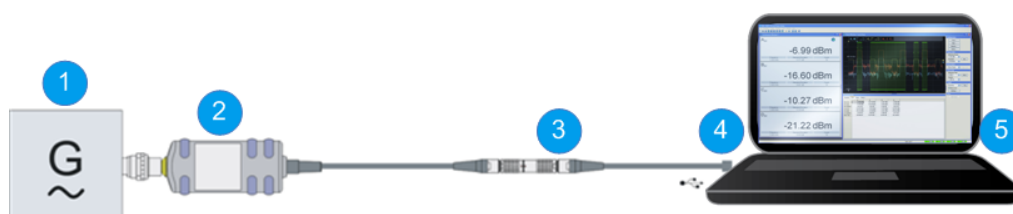

Figure 6-1: Setup with an R&S NRP-Z4 and an R&S NRPV

- 1 = Signal source
- 2 = R&S NRP-Z power sensor
- 3 = R&S NRP-Z4
- 4 = USB connector
- 5 = PC with installed R&S NRPV



Incorrectly connecting/disconnecting the R&S NRP-Z power sensors may damage the power sensors or lead to erroneous results.

Ensure that you connect/disconnect your power sensors as described in [Chapter 4.4, "Connecting the R&S NRP-Z Power Sensors"](#), on page 12 and [Chapter 4.5, "Disconnecting the R&S NRP-Z Power Sensors"](#), on page 14.

Starting a measurement

1. Connect the power sensor to the PC as shown in [Figure 6-1](#).
2. On the PC, start the R&S NRPV software.
3. Connect the power sensor to the PC. For a detailed description, see [Chapter 5, "Connecting to a PC"](#), on page 16.
4. If you use the power sensor for the first time with the R&S NRPV software, activate the sensor using a license key:
 - a) In the "File" menu, select "File" > "Licensing".
The "Licensing NRP-Z Power Sensors for NRPV" dialog opens.

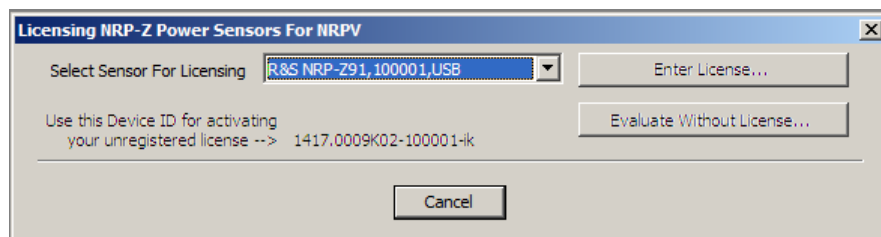

- b) Select your power sensor.
- c) Select "Enter License".
The "License Activation" dialog opens.

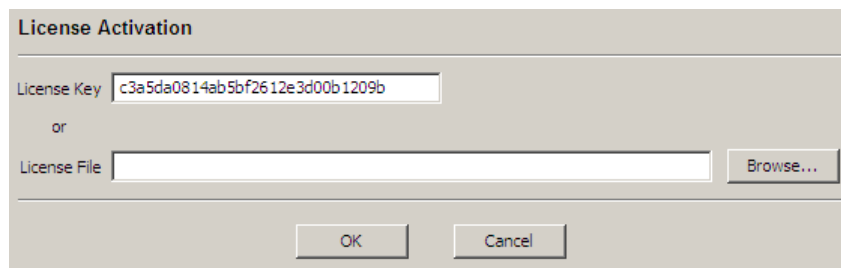

- d) Enter the license key either manually or with the key code file.
- e) Confirm with "OK" to return to the "Licensing NRP-Z Power Sensors for NRPV" dialog. The dialog indicates all currently connected sensors.

Note: If you want to evaluate the R&S NRPV before buying a license for your power sensor, you can activate a sensor for temporary use. To do so, select "Evaluate Without License" in the "Licensing NRP-Z Power Sensors for NRPV" dialog. For a detailed description, refer to the operating manual of the R&S NRPV.

5. Switch on the test signal of the signal source.
6. To start a continuous measurement, select "Measure" > "Continuous".
The "Continuous" measurement window appears. It shows the measurement results numerically, and the control panel for accessing further dialogs with parameters for measurement, evaluation and display.

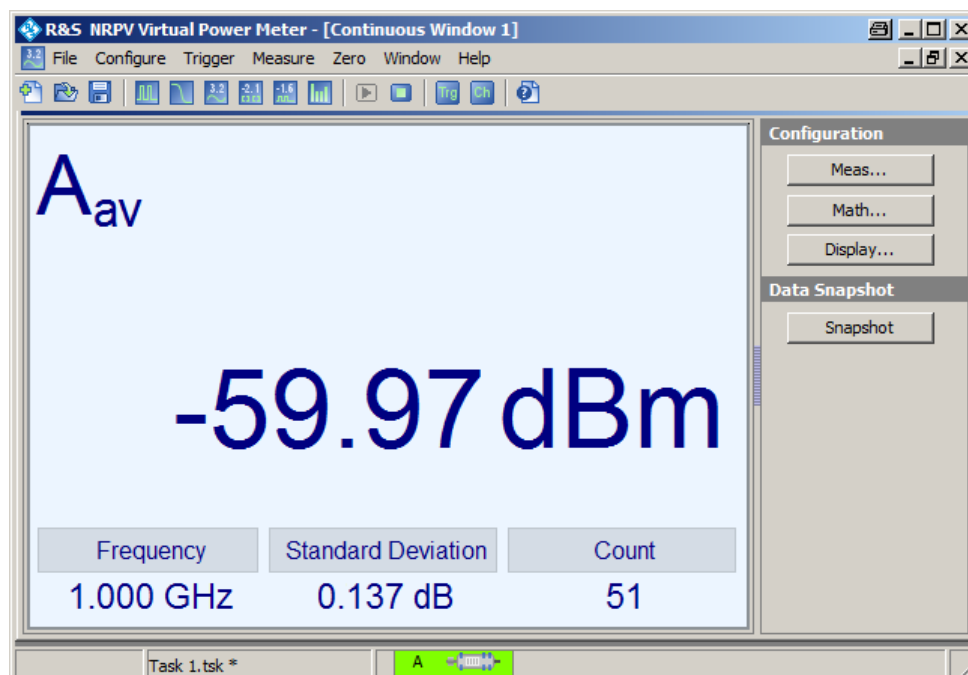

For a detailed description of how to measure in this setup, refer to the operating manual of the R&S NRPV.

6.3 R&S Power Viewer Plus

The R&S Power Viewer Plus is software that simplifies many measurement tasks. It is provided on your documentation CD-ROM and on the Rohde & Schwarz website as a separate standalone installation package.

For details on installing and operating the R&S Power Viewer Plus, refer to its operating manual. The manual is provided on the documentation CD-ROM and is installed automatically during the installation of the R&S Power Viewer Plus.

6.4 Android Device

With an R&S NRP-Z power sensors and an android device, you can measure continuous power that requires high level of mobility.

Required equipment

- R&S NRP-Z power sensor
- R&S NRP-Z3 or R&S NRP-Z4 USB adapter
- Android device that fulfills the following requirements:
 - Android version 4.0 or higher
 - USB host controller - USB On The Go (USB-OTG)

- Compatible driver for the USB-OTG hardware. Make sure that this driver is already integrated in the device's kernel. Usually it cannot be installed separately.
- Installed R&S Power Viewer Mobile app
- USB-OTG adapter

NOTICE**Risk of impossible critical communication due to battery drain**

Always disconnect the sensor from the host device when the sensor is not in use. Leaving the sensor connected to the device drains the device battery, potentially making critical communications, such as an emergency call, impossible.

Setup

Figure 6-2: Setup with an Android device

- 1 = Signal source
- 2 = R&S NRP-Z power sensor
- 3 = R&S NRP-Z4
- 4 = USB-OTG cable
- 5 = USB socket
- 6 = Android device

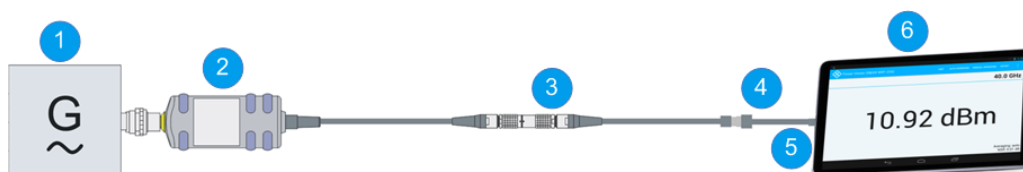

Incorrectly connecting/disconnecting the R&S NRP-Z power sensors may damage the power sensors or lead to erroneous results.

Ensure that you connect/disconnect your power sensors as described in [Chapter 4.4, "Connecting the R&S NRP-Z Power Sensors"](#), on page 12 and [Chapter 4.5, "Disconnecting the R&S NRP-Z Power Sensors"](#), on page 14.

Starting a measurement

1. Connect the cables as shown in [Figure 6-2](#):
 - a) Connect the power sensor to the R&S NRP-Z3 or R&S NRP-Z4 USB adapter. See ["To connect to an adapter"](#) on page 13.
 - b) Connect the USB-OTG adapter to the R&S NRP-Z3 or R&S NRP-Z4.
 - c) Plug the USB-OTG adapter into the Android device. The R&S Power Viewer Mobile app starts automatically.
2. The first time you start the app, you need to accept the Rohde & Schwarz end-user license agreement.
3. Explicitly authorize the R&S Power Viewer Mobile app to access the connected power sensor.

- To skip this authorization for future uses, enable "Use by default for this USB device" before clicking OK.
If this dialog box appears multiple times, click "OK" each time to grant access.

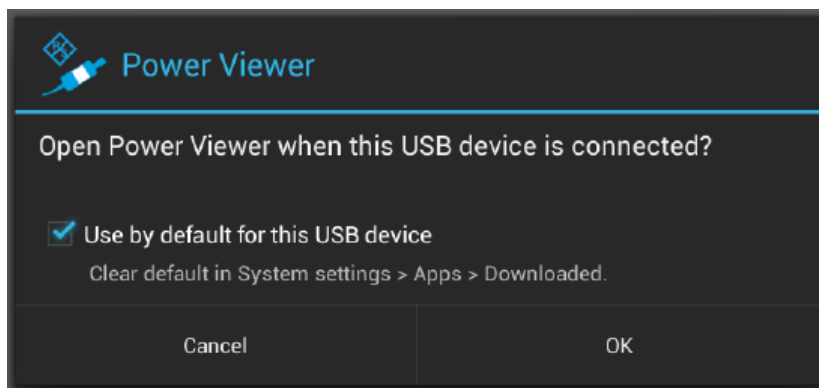

- After the app has detected the connected sensor, the result of the measurement appears on the screen.



For a detailed description of how to measure in this setup, refer to the application note "1MA215: Using R&S®NRP-Z Power Sensors with Android Handheld Devices" provided on the documentation CD-ROM and on the Rohde & Schwarz website.

6.5 R&S NRP2

With the R&S NRP-Z power sensors and an R&S NRP2, you can measure power with up to four power sensors simultaneously, depending on the base unit configuration. All sensor-dependent measurement functions can be used and the results can be displayed in parallel.

Required equipment

- R&S NRP-Z power sensor
- R&S NRP2 base unit

Setup

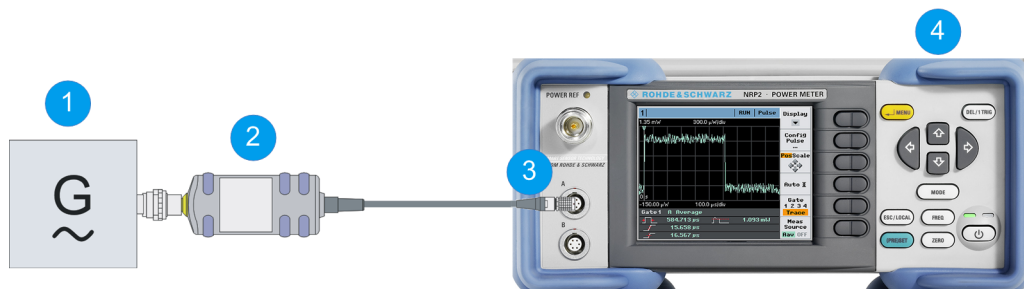

Figure 6-3: Setup with an R&S NRP2 base unit

- 1 = Signal source
- 2 = R&S NRP-Z power sensor
- 3 = SENSOR connector of the R&S NRP2
- 4 = R&S NRP2 base unit



Incorrectly connecting/disconnecting the R&S NRP-Z power sensors may damage the power sensors or lead to erroneous results.

Ensure that you connect/disconnect your power sensors as described in [Chapter 4.4, "Connecting the R&S NRP-Z Power Sensors"](#), on page 12 and [Chapter 4.5, "Disconnecting the R&S NRP-Z Power Sensors"](#), on page 14.

Starting a measurement

1. Connect the power sensor to the SENSOR connector of the R&S NRP2 as shown in [Figure 6-3](#).
2. Preset the R&S NRP2.
3. Execute zeroing.

Note: Turn off all test signals before zeroing. An active test signal during zeroing causes an error.
4. Connect the power sensor to the signal source.

The result window indicates the result (in dBm) obtained with sensor A.

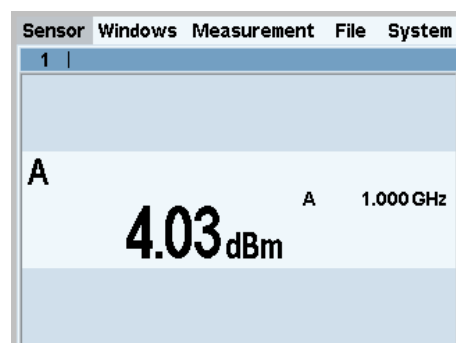

5. If necessary, perform further settings.

For a detailed description of how to measure in this setup, refer to the operating manual of your R&S NRP2.

6.6 Compatible Instrument

Many Rohde & Schwarz instruments allow power measurements using the R&S NRP-Z power sensors. For example, the power sensors can be used with a signal generator to achieve stable and accurate RF power, which can be further supplied to your DUT.

You can connect the power sensors to the following instrument connectors:

- Directly to the SENSOR connector
- To the USB port of the instrument, using an R&S NRP-Z3 or R&S NRP-Z4 USB adapter
- To the USB port of the instrument, using an R&S NRP-Z5 USB hub

Refer to the operating manual of your Rohde & Schwarz instrument to find out if it supports power measurements with the R&S NRP-Z power sensors.

Required equipment

- R&S NRP-Z power sensor
- Compatible Rohde & Schwarz instrument
- R&S NRP-Z3 or R&S NRP-Z4 USB adapter or an R&S NRP-Z5 sensor hub (optional)

Setup



Figure 6-4: Setup with an R&S SMF

- 1 = R&S SMF
- 2 = Device under test (DUT)
- 3 = R&S NRP-Z icon
- 4 = SENSOR connector
- 5 = R&S NRP-Z Power Sensors
- 6 = RF output of the DUT
- 7 = RF OUT connector of the R&S SMF
- 8 = RF input of the DUT



Incorrectly connecting/disconnecting the R&S NRP-Z power sensors may damage the power sensors or lead to erroneous results.

Ensure that you connect/disconnect your power sensors as described in [Chapter 4.4, "Connecting the R&S NRP-Z Power Sensors"](#), on page 12 and [Chapter 4.5, "Disconnecting the R&S NRP-Z Power Sensors"](#), on page 14.

Starting a measurement

1. Connect the cables as shown in [Figure 6-4](#):
 - a) Connect the DUT to the RF OUT connector of the R&S SMF.
 - b) Connect the DUT to the RF connector of the power sensor.
 - c) Connect the power sensor to the SENSOR connector of the R&S SMF.
2. On the R&S SMF, open the "NRP-Z Power Viewer" dialog.

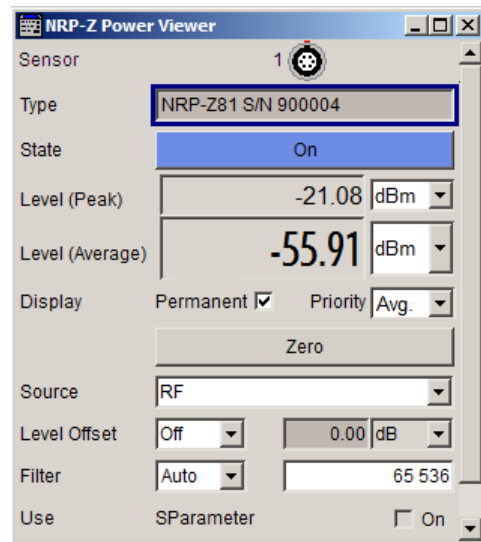

The dialog shows the result (in dBm) and some additional parameters.

3. If necessary, perform further settings.

For a detailed description of how to measure in this setup, refer to the operating manual your compatible Rohde & Schwarz instrument.

7 Remote Control

Use remote control to integrate the R&S NRP-Z power sensors into custom automatic test equipment (ATE) systems. The latest version of the available instrument drivers is part of the R&S NRP Toolkit SDK under Windows.

For a detailed description on how to perform different remote measurements, refer to various sample programs installed with the R&S NRP Toolkit SDK, or the application note "1GP69: R&S®NRP-Z Power Sensor Programming Guide".

Index

A

Android device	28
Application cards	6
Application notes	6

B

Brochures	6
-----------------	---

C

Checking the delivery	11
Connecting	
Host connector	13
RF	12
To a PC	16
Connector	
Host	12
Overview	11
RF	12

D

Data sheets	6
Disconnecting	
Host connector	14
RF	14
Documentation overview	5

E

EMI suppression	10
-----------------------	----

F

Firmware update	26
-----------------------	----

G

Getting started	5
-----------------------	---

H

Host connector	12
----------------------	----

I

Instrument	
Supporting power measurement	32
Instrument security procedures	5
Interface	
Overview	11
Introduction	8

O

Open source acknowledgment (OSA)	6
Operating concepts	21
Android device	28
Compatible instrument	32
R&S NRP Toolkit	21
R&S NRP2	30
R&S NRPV	26
R&S Power Viewer Plus	28

P

PC	
Active USB adapter	17
Connection types	16
Passive USB adapter	16
USB sensor hub	18
Powering the R&S NRP-Z power sensor	15
Preparing for use	10

R

R&S NRP Toolkit	21
Components for Windows-based systems	22
Installation under Linux	23
Installation under Mac OS X	23
Installation under Windows	22
System requirements	21
R&S NRP-Z5	18
R&S NRP2	30
R&S NRPV	26
R&S Power Viewer Plus	28
Release notes	6
Remote control	34
RF connector	12

S

Safety information	7
Safety instructions	5
Security procedures	5

T

Tutorials	5
-----------------	---

U

Unpacking the delivery	11
USB connection	16, 17
USB sensor hub	18
User manual	5

W

White papers	6
--------------------	---

X-ON Electronics

Largest Supplier of Electrical and Electronic Components

Click to view similar products for Rohde & Schwarz manufacturer:

Other Similar products are found below :

[HMC8042](#) [HZ10R](#) [HMP2020](#) [HMP2030](#) [HMP4040](#) [RT-ZP03](#) [HV512](#) [R&S HMF2525](#) [RTB2K-102](#) [RTC1K-102](#) [RTC1K-202](#)
[SMC100A/B103/B1](#) [HA-Z211](#) [RTB2002 \(RTB2K-72\)](#) [RTB2004 + RTB-B242 \(RTB2K-204\)](#) [RTB2004 + RTB-B242 + RTB-B1 \(RTB2K-204M\)](#) [RTB2004 + RTB-B243 + RTB-B1 \(RTB2K-304M\)](#) [RTM3004 + RTM-B222 \(RTM3K-24\)](#) [RTM3002 + RTM-B223 \(RTM3K-32\)](#)
[RTM-B222](#) [RTM-B223](#) [RTM-B225](#) [RTM-B2210](#) [RTM-B243](#) [RTM-B2410](#) [RTM-B1](#) [R&S® FPH-B8](#) [NGE102B](#) [NGE103B](#) [NGL-K103](#)
[FPC-COM1](#) [RTB2K-202](#) [RTB2K-204](#) [HMC8012](#) [HZ42](#) [R&S HMC8012G](#) [RTB2K-104](#) [SMC100A/B103](#) [HA-Z302](#) [RT-ZA21](#) [RTB2002 +](#)
[RTB-B221 \(RTB2K-102\)](#) [RTB-PK1](#) [RTC1002 \(RTC1K-52\)](#) [RTC1002 + RTC-B221 \(RTC1K-102\)](#) [RTM-K1](#) [RTM-B242](#) [R&S NRX](#) [R&S](#)
[RTM-K36](#) [R&S HM7042-5](#) [RTB2K-74](#)