

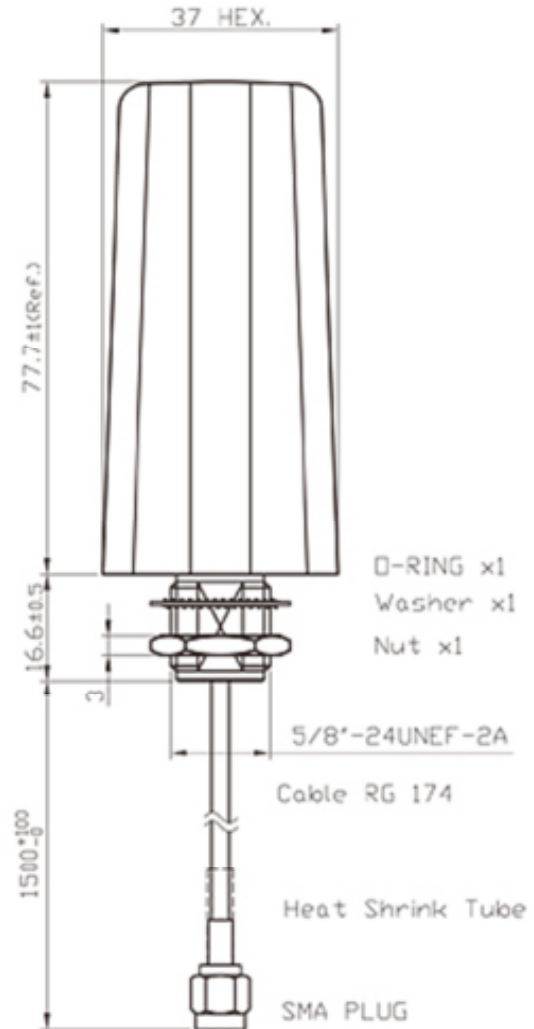

## Key Specifications - Electrical

Operating temperature:	-20 to +65°C
Storage temperature:	-30 to +70°C
Impedance:	50 ohm
Gain:	1 / 3 / 5dBi
VSWR:	≤3.0
Frequency range:	698 - 960MHz
	1710 - 2170MHz
	2300 - 2700MHz
Radiation:	Omni-directional
Polarization:	Vertical
HBPW ± 3dB@EPlane:	120° @ 698-960MHz @ EPlane
	50° @ 1710-2170MHz @ EPlane
	30° @ 2300-2700MHz @ EPlane
HBPW ± 3dB@HPlane:	360° @ 698-960MHz @ HPlane
	360° @ 1710-2170MHz @ HPlane
	360° @ 2300-2700MHz @ HPlane



## Key Specifications - Mechanical

Weight:	140g
Cable:	RG174
Connector:	SMA Plug
Waterproof:	IP65

## Test Reports

### Return Loss / VSWR

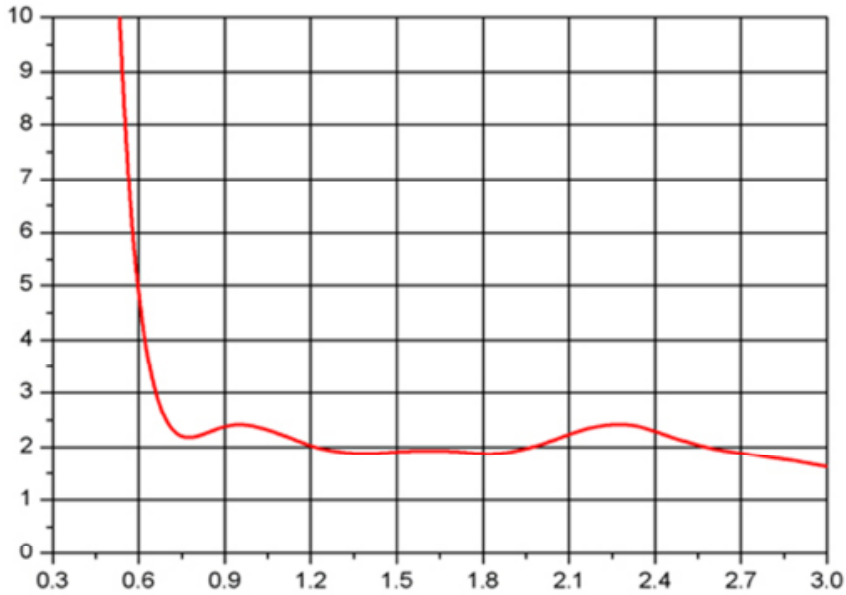

### Pattern

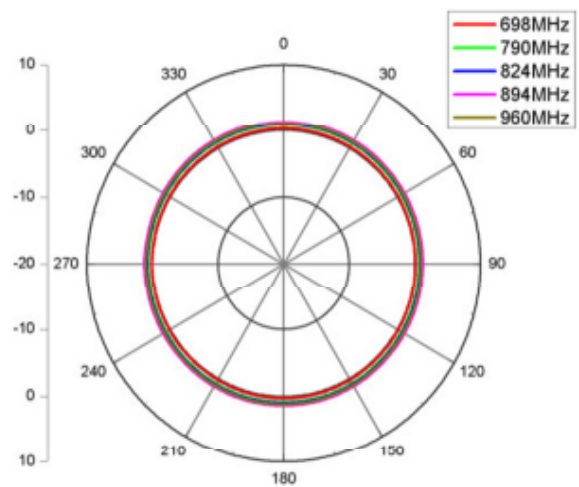
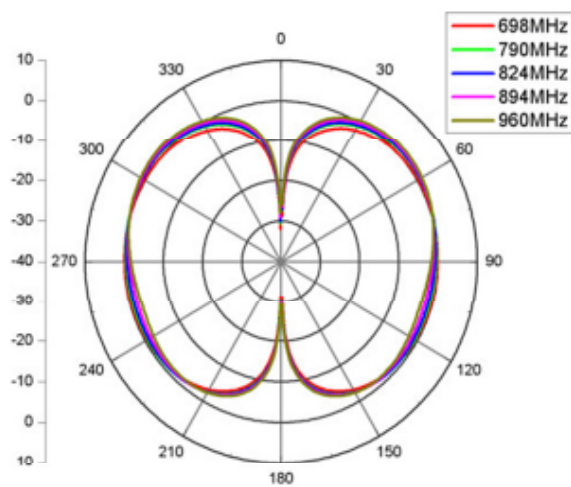

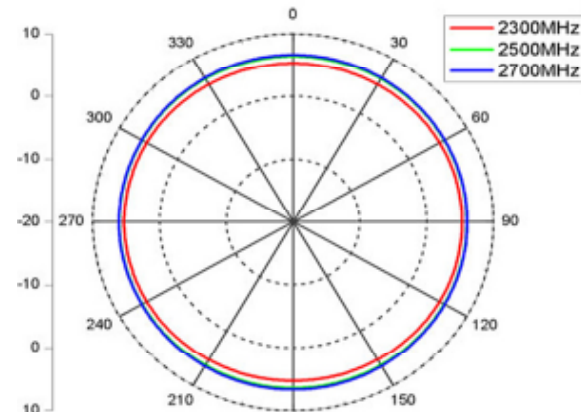
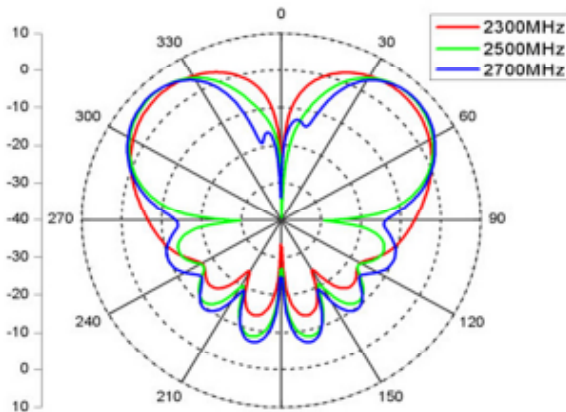
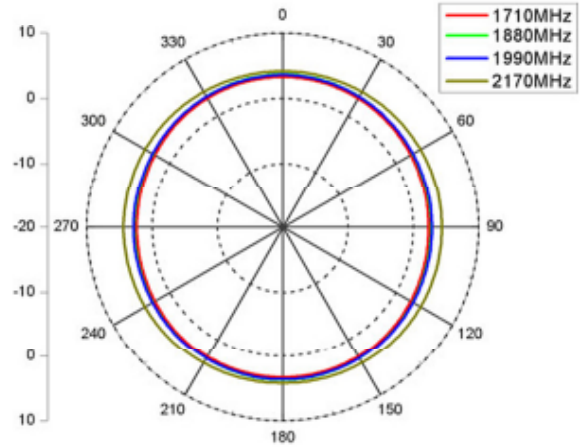
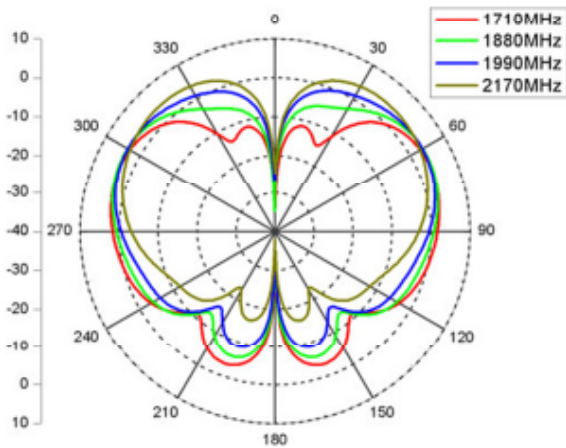

### Return Loss - 2.5M cable

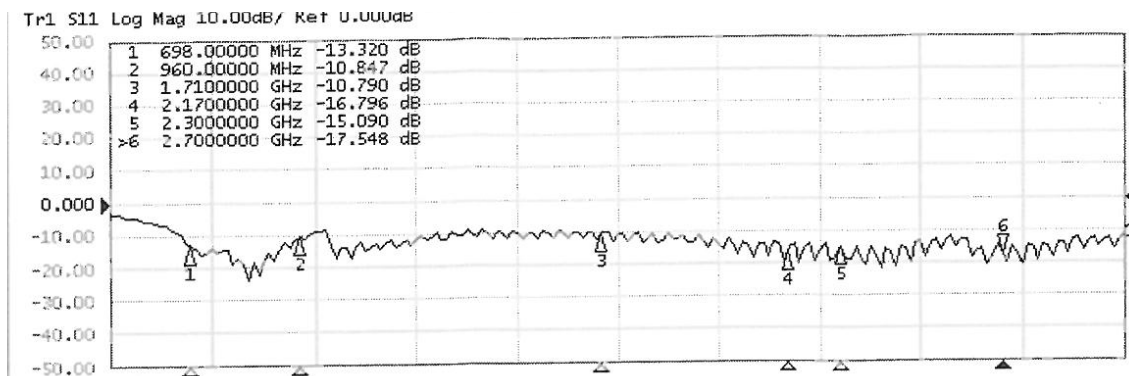

### VSWR - 2.5M cable

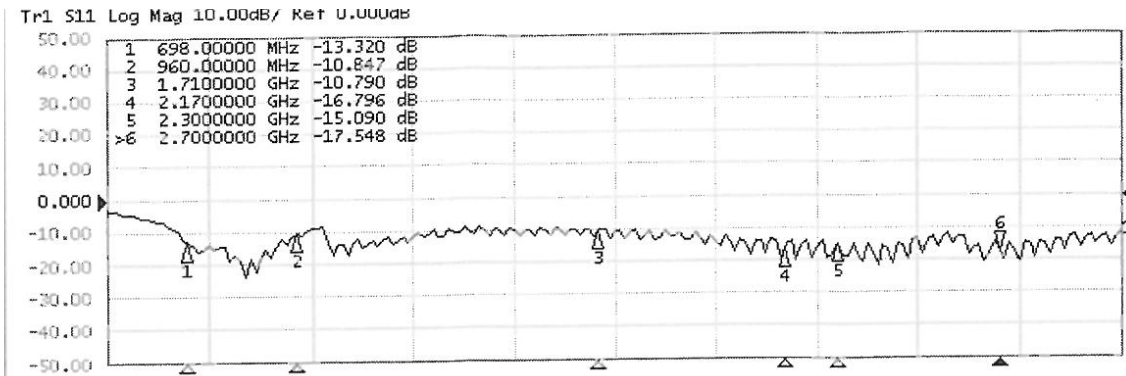

### Return Loss - 5M cable

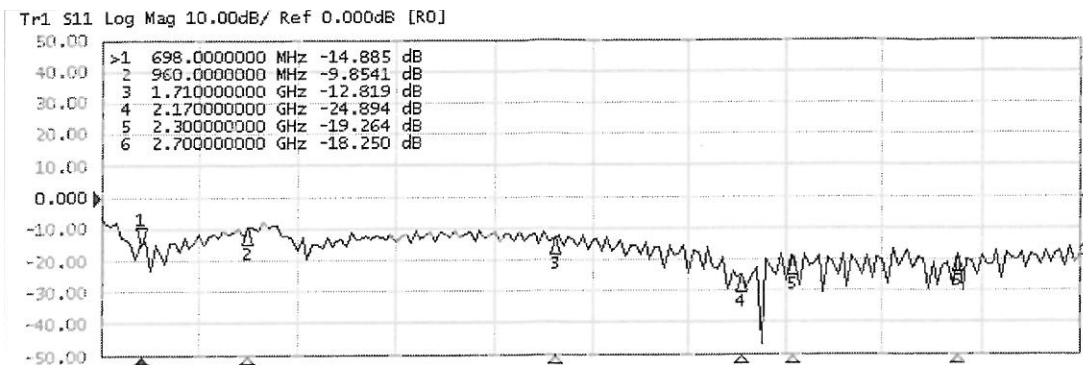

### Return Loss - 5M cable

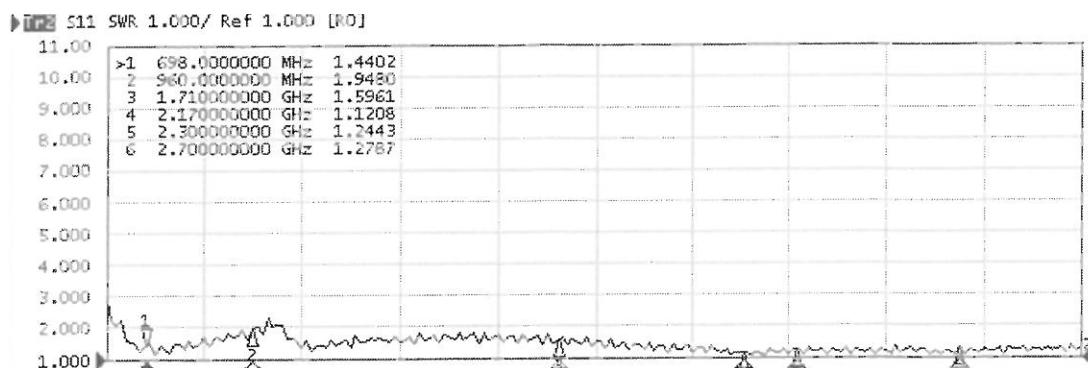

## X-ON Electronics

Largest Supplier of Electrical and Electronic Components

*Click to view similar products for [SIRETTA](#) manufacturer:*

Other Similar products are found below :

[ALPHA4A/5M/SMAM/S/S/26](#) [DELTA5A/X/SMAM/S/S/17](#) [OSCAR17/X/TNC/S/S/19](#) [DELTA5A/X/BNCM/S/S/17](#) [SNYPER-LTE-SPECTRUM](#) [ASMA2000F058L13](#) [ASMA2000C058L13](#) [TANGO14/5M/LL/SMAM/S/S/24](#) [TANGO1/1M/FMEF/S/S/4](#) [ASME500F058L13](#) [TANGO3/0.5M/SMAM/S/S/31](#) [TANGO40/X/NTYPEF/S/S/32](#) [QUARTZ-W22-LTE\(EU\)+ACC](#) [ASMA500B174L13](#) [31557](#) [ECHO40/0.1M/UFL/S/S/32](#) [MIKE1A/5M/FMEF/S/S/20](#) [QUARTZ-W22-UMTS\(EU\)+ACC](#) [TANGO11A/2.5M/SMAM/S/S/19](#) [ASMA500F058L13](#) [ZETA-N-UMTS](#) [ECHO11/0.2M/IPEX/S/S/12](#) [ASMA300E174L13](#) [ASMA1000F058L13](#) [DELTA19/X/SMAM/S/S/35](#) [ASMA2000E058L13](#) [ASMZG300F058L13](#) [MIKE3A/5M/SMAM/S/S/17](#) [TANGO15/3M/SMAM/SMAM/S/S/24](#) [TANGO20/3M/SMAM/S/S/26](#) [ASMZG500A058L13](#) [ASMZG1500F058L13](#) [ALPHA1A/2.5M/SMAM/S/S/11](#) [OSCAR40/10M/LL/SMAM/S/S/33](#) [TANGO11A/5M/LL/SMAM/S/S/19](#) [TANGO29/1M/SMAM/RP/S/35](#) [ASME2000F058L13](#) [ASMK015X174S11](#) [LC300-N2-GPRS](#) [DELTA6A/X/SMAM/S/S/11](#) [MIKE1A/2.5M/FMEF/S/S/20](#) [ASMZG1000F058L13](#) [OSCAR41/X/NTYPEF/S/S/29](#) [TANGO22/3M/SMAM/SMAM/SMAM/26](#) [OSCAR420/0.4M/NTYPEF/S/S/19](#) [ASMK010X174S11](#) [ZETA-N2-GPRS](#) [ADAPT/SMAM/RP](#) [OSCAR18/X/NF/S/S/22](#) [TANGO14/3M/SMAM/S/S/24](#)