

Eaton is dedicated to ensuring that reliable, efficient and safe power is available when it's needed most. With unparalleled knowledge of electrical power management across industries, experts at Eaton deliver customized, integrated solutions to solve our customers' most critical challenges.

Our focus is on delivering the right solution for the application. But, decision makers demand more than just innovative products. They turn to Eaton for an unwavering commitment to personal support that makes customer success a top priority. For more information, visit [www.eaton.eu](http://www.eaton.eu).

To contact an Eaton salesperson or local distributor/agent, please visit [www.eaton.eu/electrical/customersupport](http://www.eaton.eu/electrical/customersupport)

Changes to the products, to the information contained in this document, and to prices are reserved; so are errors and omissions. Only order confirmations and technical documentation by Eaton is binding. Photos and pictures also do not warrant a specific layout or functionality. Their use in whatever form is subject to prior approval by Eaton. The same applies to Trademarks (especially Eaton, Moeller, Cutler-Hammer). The Terms and Conditions of Eaton apply, as referenced on Eaton internet pages and Eaton order confirmations.

Eaton Industries GmbH  
Hein-Moeller-Str. 7-11  
D-53115 Bonn/Germany

© 2013 by Eaton Corporation  
All rights reserved  
Printed in Germany 02/13  
Publication No.: CA05303\_EN-INT  
ip February 2013  
Article No.: 171796



Eaton is a registered trademark of Eaton Corporation  
All other trademarks are property of their respective owners.



Product range catalog for sensors

Inductive sensors  
Optical sensors  
Capacitive sensors



# Product range catalog

## Sensors – products, basic information, applications





# The power of fusion

1874 1886 1893 1899 1906 1908 1911 1962 1963 1983 1990 1998 1999

1874: R&G  
1886: W  
1893: G  
1899: Klockner MOELLER  
1906: BILL  
1908: MEM  
1911: Klöckner MOELLER  
1962: POWERWARE  
1963: HOLEC  
1983: MGE Office Protection Systems  
1990: SANTAK  
1998: CHANGSEN  
1999: MOELLER

**EATON**  
Powering Business Worldwide

There's a certain energy at Eaton. An energy produced by the combination of globally established engineering companies into one brand. One brand that cleverly and efficiently meets all your requirements in the field of power management and industrial automation. Energy for our customers worldwide – That's what we mean by 'Powering Business Worldwide'. From power distribution and control to industrial automation right through to uninterruptible power supply.

Eaton helps you to manage your entire power system proactively and efficiently. For this we offer you electrical solutions that make your applications safer, more reliable and highly efficient. Visit us at [www.eaton.com/electrical](http://www.eaton.com/electrical).

All the above are trademarks of Eaton Corporation or its affiliates. The Westinghouse brand name is used by temporary license in Asia Pacific. ©2009 Eaton Corporation.

## Service and consulting for UPS systems and hydraulic solutions.

Further developing relations with our customers is particularly important to us. Your requirements and suggestions will be passed on promptly to the relevant specialists. After all, we take up the challenges you give us as if they were our own.



### Are your questions about uninterruptible power supplies (UPSs)?

#### Technical support

If you have any questions about our products and for technical advice send an email to our support team:

[supportgermany@eaton.com](mailto:supportgermany@eaton.com)

or contact our telephone hotline at

Tel.: +49 (0)7841 604 - 334

#### Service

If you have a problem or a fault on one of our products contact us by email:

[servicegermany@eaton.com](mailto:servicegermany@eaton.com)

or contact us by phone at:

Tel.: +49 (0)7841 604 - 334

We can be contacted here between  
Monday – Thursday from 08.00 – 17.00 CET  
and Friday from 08.00 – 16.00 CET.

### Are your questions about hydraulic solutions?

Please contact the help desk of our Customer Service in Baden-Baden. This service will put you in touch with a customer contact in your locality.

#### Our customer service:

Eaton Hydraulics Group  
Dr.-Reckeweg-Straße 1  
D-76532 Baden-Baden  
Tel.: +49 (0)7221 682 - 0  
Fax: +49 (0)7221 682 - 788  
Email: [customersupportmea@eaton.com](mailto:customersupportmea@eaton.com)

## Eaton's After Sales Service

This is the new name of Moeller's tried and trusted Field Service. Only the name has changed. The reliable and first-class service has stayed the same. Further information and general terms and conditions can be found at [www.moeller.net/en/support/fieldservice/index.jsp](http://www.moeller.net/en/support/fieldservice/index.jsp).

#### Service specialists

Use our service personnel. Extensive know-how, combined with many years of experience and state-of-the-art equipment to help you find a solution for your tasks.

#### Material

Components, assemblies and spare parts for the Eaton product range are available for your applications.

#### Service products

Eaton's After Sales Service offers the right service packages for your products.

#### Hotline

Free hotline for round-the-clock support.  
+49 (0)180 522 3822 (24/7)  
0.12 euros per minute for calls from within the German Telecom network

#### Onsite service

Repair and replacement service for Eaton devices.

#### Repairs

Onsite service, analysis, conversions, expansions and maintenance.

#### Online services

Downloads, FAQs and interactive troubleshooting

Inductive Sensors	
<b>E52-Serie</b>	
Description	8
Ordering/Engineering/Dimensions	9
Technical data	10
<b>E55-Serie</b>	
Description	11
Ordering	12
Technical data	13
Engineering/Dimensions	14
<b>E56-Serie</b>	
Description	15
Ordering/Engineering/Dimensions	16
Technical data	17
<b>E57 Global series</b>	
Description	18
Ordering	19
Engineering	23
Technical data	24
Dimensions	26
<b>E57-Premium-Plus-Short</b>	
Description	28
Ordering	29
Engineering	35
Technical data	36
Dimensions	37
<b>Miniature series E57</b>	
Description	39
Ordering/Technical data	40
Engineering/Dimensions	41
<b>iProx series</b>	
Description	42
Ordering	43
Technical data/Engineering/Dimensions	44
<b>E59 AccuProx series</b>	
Description	45
Ordering	47
Engineering	48
Technical data	49
Dimensions	49

Optical sensors	
<b>Comet-Serie</b>	
Description Comet-Serie	50
Ordering Comet-Serie	51
Description FO cable	56
Ordering FO cable	57
Engineering	59
Technical data	61
Dimensions	62
<b>E58-Serie</b>	
Description	66
Ordering	67
Engineering	68
Dimensions/Technical data	69
<b>E65-SM-Serie</b>	
Description	70
Ordering	71
Technical data	72
Engineering/Dimensions	73
<b>E67-Serie</b>	
Description	74
Ordering/Dimensions	75
Engineering/Technical data	76
<b>E71 series NanoView</b>	
Description	77
Ordering	78
Engineering	79
Technical data/Dimensions	80
<b>E75/E76 series IntelliView</b>	
Description	81
Ordering	84
Engineering	85
Technical data	87
Dimensions	88
<b>Capacitive sensors</b>	
<b>E53-Serie</b>	
Description	89
Ordering	90
Engineering	93
Technical data	93
Dimensions	94
<b>Accessories</b>	
Ordering	95
Dimensions	100
<b>Basic information</b>	<b>103</b>
<b>Applications</b>	<b>113</b>
<b>Appendix</b>	<b>116</b>





Aerospace



Truck



# Powering Business Worldwide

## Discover Eaton – a leader in the power management field

Since 1911, when our company began trading as a small truck parts supplier, Eaton® Corporation has come a long way. Today, as a diversified power management company, Eaton has sales of \$16 billion USD (FY 2011), employs 73,000 people and has customers in more than 150 countries. Everyday, we help companies across the world to manage power, and do more, while consuming less energy.

Eaton's innovative products, solutions and technologies are designed to help customers to manage power and conserve resources while working more productively, safely and sustainably. Our integrated and diversified business strategy ensures that we remain at the forefront of our industry, decade after decade.

### Aerospace

A leading global supplier to commercial and military aviation and aerospace industries. An extensive technology portfolio includes hydraulic systems, fuel systems, motion control systems, propulsion sub-systems, cockpit controls and displays and fluid health monitoring systems. Our products improve fuel economy, aircraft performance, reliability and safety.

### Truck

A leader in the design, manufacture and marketing of complete line of drivetrain systems and components for medium- and heavy-duty commercial vehicles. Under the "Roadranger" brand, Eaton also markets lubricants, safety products and service tools. Eaton's hybrid power systems have earned the company recognition as a global leader in alternative power for commercial vehicles.

### Electrical

A global leader in electrical control, power distribution, uninterruptible power supply and industrial automation products and services. Our products provide customer-driven PowerChain Management® solutions to serve the power system needs of the industrial, institutional, government, utility, commercial, residential, IT, mission critical and OEM markets worldwide.







## Powering business more sustainably

### Sustainability – smaller footprint in the world

The principle of sustainability means meeting the current needs of our own society without compromising the needs or options of future generations. It is a principle, which forms the very core of our design and production philosophy and guides all our activities across the world. Our commitment to reducing our own ecological footprint covers a wide range of green technologies, products and services that help our customers utilise electrical power more efficiently, while improving environmental performance.



Eaton has been recognised throughout the world for its uncompromising business ethics. For example, it was listed as one of the 'World's Most Ethical Companies' on the Ethisphere Institute's annual list for six consecutive years (2007, 2008, 2009, 2010, 2011 and 2012).

### Automotive

A supplier of critical components that reduce emissions and fuel consumption and improve stability and performance of cars, light trucks and commercial vehicles. Principal products include engine valves and valve train components, transmission and engine controls, supercharger, locking and limited slip differentials, cylinder heads, fluid conveyance components, body mouldings and spoilers.

### Hydraulics

A worldwide leader in reliable, high-efficiency hydraulic systems and components for use in mobile and industrial applications. Markets include agriculture, construction, mining, forestry, utility, material handling, earth moving, truck and bus, machine tools, moulding, primary metals, automotive, power generation, port machinery and entertainment.



An Eaton Green Solution

Learn more about Eaton Green Solutions at [www.eaton.com/greensolutions](http://www.eaton.com/greensolutions)

When you see this symbol, you know the solution represents an Eaton benchmark for environmental performance.



# Powering electrical systems worldwide

## Buildings

- Residential
- Healthcare
- Education
- Commercial offices
- Retail
- Public sector
- Airports
  
- Electrical distribution solutions for safe and efficient power delivery
- Power quality systems for uptime and reliability
- Power metering and monitoring to add intelligence and save costs
- Industrial control products for HVAC applications

## Information Technology

- Data centers
- Telecommunication
- Networks
- Computer rooms
  
- World's most efficient line of UPSs to reduce footprint and save energy
- Reliable power systems with inherent redundancy to improve availability
- Power metering and monitoring to diagnose problems and lower costs
- Local service and support for quick response





#### Public and private sectors

Buildings, Information Technology, Industrial & Machinery, Energy & Utilities  
We provide reliable, efficient and safe power management.

### Industrial & Machinery

- Machine building:
  - Food and packaging machines
  - Woodworking and processing machines
- Agriculture
- Construction
- Mining and metals
- Paper industry
- Chemical and pharmaceutical industry
- Automotive industry
- Logistics centers
- Electrical distribution equipment to deliver power throughout the enterprise
- Control & automation and power quality equipment for process control
- Power metering and monitoring to manage energy costs and uptime
- Power and motion control products to optimize productivity, reliability, safety and operator comfort

### Energy & Utilities

- Renewable energy:
  - Solar
  - Wind
  - Hydropower
- Traditional energy:
  - Oil
  - Gas
- Smart grid
- Water and waste water
- Electrical balance of system and turnkey services for residential, utility and commercial solar installations
- Power distribution equipment, control components and system installations services
- Network power grid technology for intelligent data, lower costs and crew/public safety

# Sensors optimized for OEM applications

Machine builders need robust, reliable, and cost-effective sensors for a variety of challenging applications.

To meet those Eaton is your global partner.

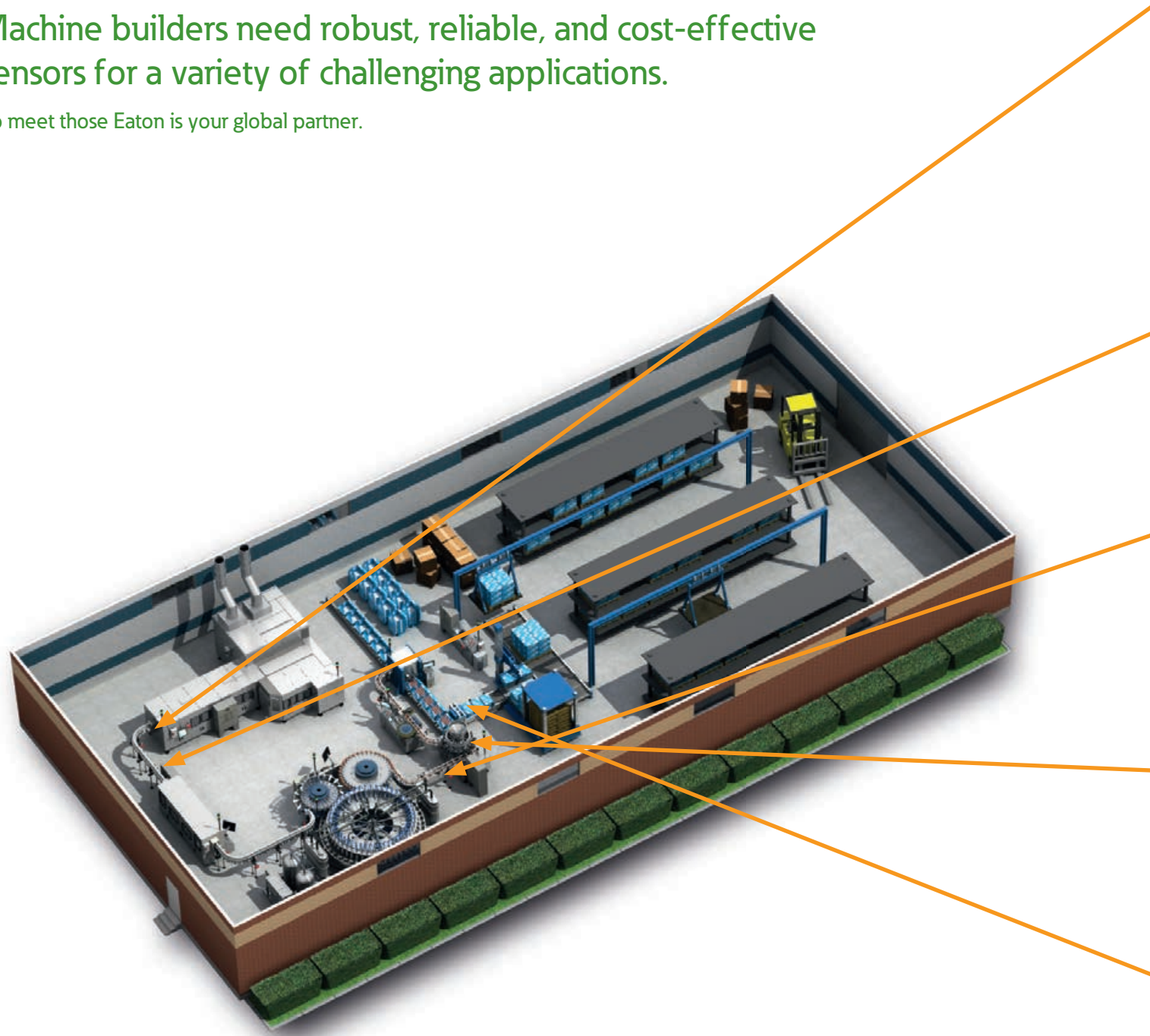





## Molding

Injection blow molding machines transform raw plastic into molded bottles. These machines heat the plastic, inject it into a cavity, and expand the plastic to its final shape. Capacitive sensors and photoelectric sensors can be used to detect the level of plastic pellets in the input hopper; to verify tooling positions and count parts coming out of the molds; and can be used after the operation to verify correct bottle volume and dimensions at much lower cost and complexity than vision-based systems.



## Transporting

Air transport moves product from one station to the next at incredible speed, all while a vacuum seal on open containers keeps bottles contaminant-free. Along the line, specialized photoelectric sensors with an ability to detect clear objects can be used to count bottles as they fly by, also looking for unusual gaps between adjacent products that might indicate a missing or dropped product.



## Filling

Photoelectric sensors can be used to detect both bottle and filler positions and capacitive sensors or specialized photoelectric sensors can be used to confirm correct fluid fill levels.



## Capping

As the filled bottles are moved to the capping machine, photoelectric sensors detect bottle position, and capacitive sensors can be used to confirm correct fluid fill levels. Depending on the type of cap, photoelectric and/or inductive sensors can be used to inspect for correct cap placement and tightening. Once capped, the bottles are wrapped in a plastic seal that contains special UV dyes. As the bottles leave the machine, specialized UV-sensitive photoelectric sensors can be used to confirm the presence of the safety seal around the cap.



## Packing

Bottles are batched into groupings of twelve, and moved over a cardboard box blank. The side of the cardboard is then folded up, around the product, to form the final product box. Photoelectric sensors can be used at this stage to count bottles during the batching process, to ensure that the cardboard box blank is present, and to verify the position of the batch as it is moved into place for the packing step. Sensors can also be used to verify that box sides have been folded up to the correct height, and to count finished packages moving on to a palletizer or a finished goods station.

## Description

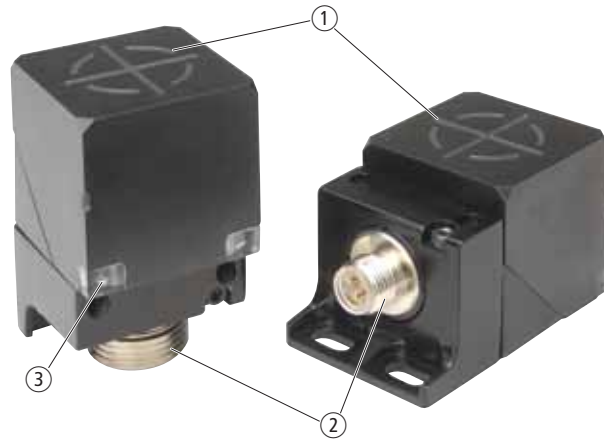

- ① Adjustable Sensing Head for Top- and Side-Sensing.
- ② Plug connector M12.
- ③ Two LED status indications.

## Short Description

Sensor E52 Cube from Eaton is a powerful inductive proximity sensor. It provides a long sensing range in a compact, standard-conformant enclosure. The outputs of this series are self-configuring as PNP or NPN, without user interaction. The E52 features additional outputs for various connection types to cover many applications with just a few models. Separate indicator lights for voltage and output signal simplify installation and fault retrieval. Five different mounting methods make these sensors exceptionally versatile. The E52 Cube has been developed specially for demanding applications, for example in car production, in bulk material plants and in metal-processing industries.

## Product Features

- Large measuring range up to 40 mm.
- Four-wire models feature additional outputs (1 × N/C, 1 × N/O).
- Four-wire DC models feature an automatic configuration function for independent NPN/PNP selection.
- Robust design featuring vibration and impact-absorbing potting compound
- Ideal for extreme temperatures or high pressure washdown environments.

## Approvals





Ordering

	Rated operational voltage $U_e$	Rated switching distance $S_n$ mm	Type of mounting	Switching type	For connection of:	Contact configuration N/O = normally open contact N/C = normally closed contact	Material	Part no. Article no.	Price see price list	Std. pack
<b>E52-Serie</b>										
4-wire 40 x 40 x 40 mm										
	10 – 48 V DC	15	Flush	NPN PNP	Plug-in connection M12 x 1	1 NC/1 N/O	Zinc/Insulated material	<b>E52Q-DL15SAD01</b> 135804		1 off
		15	Non-flush					<b>E52Q-DL15UAD01</b> 135805		
		20	Flush					<b>E52Q-DL20SAD01</b> 135806		
		20	Non-flush					<b>E52Q-DL20UAD01</b> 135807		
		25	Non-flush					<b>E52Q-DL25UAD01</b> 135808		
		30	Non-flush					<b>E52Q-DL30UAD01</b> 135809		
		35	Non-flush					<b>E52Q-DL35UAD01</b> 135810		
		40	Non-flush					<b>E52Q-DL40UAD01</b> 135811		

Information relevant for export to North America

	Product Standards	UL 508; CSA-C22.2 No. 14; IEC60947-5-2; CE marking
	UL File No.	E166051
	UL CCN	NRKH, NRKH7
	CSA File No.	UL report applies to both Canada and US
	CSA Class No.	-
	NA Certification	UL listed, certified by UL for use in Canada
	Max. Voltage Rating	48 V DC
	Degree of Protection	IEC: IP68; UL Type 4, 4X, 6, 6P, 12, 13

Engineering

Circuit diagrams

E52...

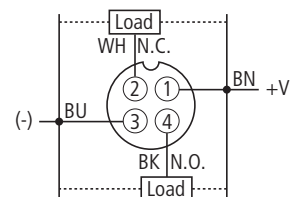

Through autoconfiguration connectable to both +V or (-).

Dimensions

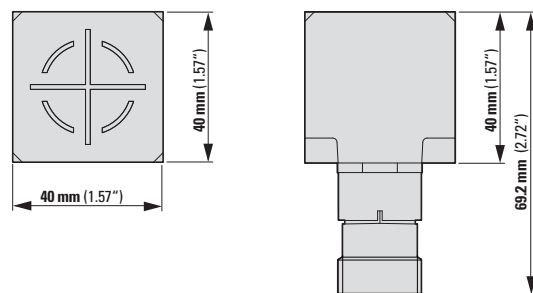

## Technical data

			E52-Serie
<b>General</b>			
Standards			IEC/EN 60947-5-2
Ambient temperature		°C	- 40 - + 70
Protection type			IP67
Mechanical shock resistance		g	30 Shock duration 11 ms
<b>Characteristics</b>			
Repetition accuracy of $S_n$		%	2
Temperature drift of $S_n$		%	10
Switching hysteresis of $S_n$		%	15
Rated operational voltage		$U_e$	10 – 48 V DC
Operating current in the switched state at 24 V DC	$I_b$	mA	25
Maximum load current	$I_o$	mA	300
Voltage drop at $I_o$	$U_d$	V	2.5
Switching Frequency		Hz	100
Residual current through the load in the blocked state at 230 V AC and 24 V DC	$I_r$	mA	0.15
Switching state display		LED	Red
Operating voltage display		LED	Green
Protective functions			Short-circuit protective device Protection against polarity reversal Protection against wire breakage
Connection			4-wire
Design (outer dimensions)		mm	40 x 40 x 40
For connection of:			Plug-in connection M12 x 1
Material			Zinc/Insulated material
Surface			Zinc alloy

## Notes

Further technical data can be found in the Online Catalog at <http://de.ecat.moeller.net>



**Description**

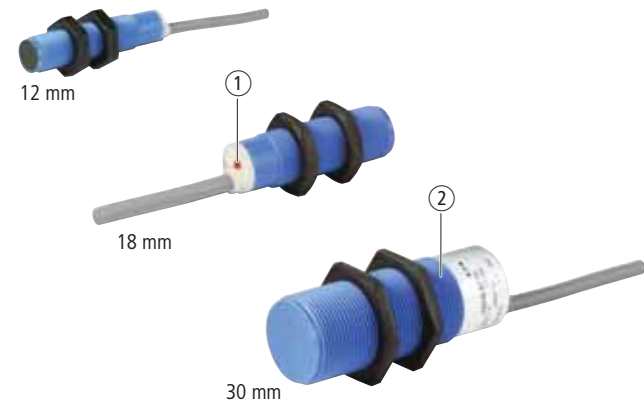

① LED for output status.  
② Corrosion-resistant PBT Housing

**Short Description**

**Cylinder design**  
Tubular Inductive Proximity Sensors by Eaton's electrical business are constructed of corrosion-resistant PBT insulated material. They are ideally suited for wash down applications such as those found in food processing plants. They are available in 12 mm, 18 mm and 30 mm diameters. Screened sensors can be embedded in metallic surfaces.

**Product Features**

- Versions for 2-conductor AC voltage or 3-conductor DC voltage.
- Threaded tubular housings in three diameters allow easy integration into new and existing applications
- Nonmetallic construction offers excellent resistance to corrosion
- All models feature an output signal indicator light.

**Approvals**



① Sensor head fitted for lateral detection. Can be rotated 90°.  
② Non-metal housing is corrosion-resistant.

**Short Description**





**Rectangular design**  
These sensors from Eaton's electrical business feature PBT resin housings for high resistance to corrosion. The housing is sized to offer a direct replacement for standard limit switches. The unique sensing head is factory assembled for top sensing, but can be easily converted in the field to any one of four side sensing positions. Models are available with sensing ranges from 15 mm to 40 mm. The sensors can be wired for N/O or N/C operation.

**Product Features**

- Nonmetallic housing offers excellent resistance to corrosion.
- Same form factor and design as standard limit switches for easy retrofit.
- Sensor head features five sensing positions (top and all four sides) that can be easily changed in the field.
- Long sensing ranges up to 40 mm.

**Approvals**

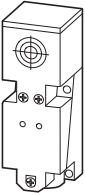

	Design (outer dimensions) mm	Rated operational voltage U <sub>e</sub>	Rated switching distance S <sub>n</sub> mm	Type of mounting	Switching type	Contact configuration N/O = normally open contact N/C = normally closed contact	Part no.	Article no.	Price see price list	Std. pack						
<b>E55-Serie</b>																
<b>2-wire</b> 2 m connection cable Insulated material																
	M12 x 1	20 - 250 V AC	2	Flush	-	1 N/O	<b>E55CAL12A2</b>	135816		1 off						
					-	1 NC	<b>E55CBL12A2</b>	135834								
			4	Non-flush	-	1 N/O	<b>E55CAL12A2E</b>	135817								
					-	1 NC	<b>E55CBL12A2E</b>	135835								
	M18 x 1	20 - 250 V AC	5	Flush	-	1 N/O	<b>E55CAL18A2</b>	135822								
					-	1 NC	<b>E55CBL18A2</b>	135839								
			8	Non-flush	-	1 N/O	<b>E55CAL18A2E</b>	135823								
					-	1 NC	<b>E55CBL18A2E</b>	135840								
	M30 x 1.5	20 - 250 V AC	10	Flush	-	1 N/O	<b>E55CAL30A2</b>	135828								
					-	1 NC	<b>E55CBL30A2</b>	135844								
			15	Non-flush	-	1 N/O	<b>E55CAL30A2E</b>	135829								
					-	1 NC	<b>E55CBL30A2E</b>	135845								
<b>3-wire</b> 2 m connection cable Insulated material																
	M12 x 1	10 - 30 V DC	2	Flush	NPN	1 N/O	<b>E55CAL12T110</b>	135818		1 off						
					PNP	1 N/O	<b>E55CAL12T111</b>	135820								
					PNP	1 NC	<b>E55CBL12T111</b>	135837								
				4	Non-flush	NPN	1 N/O	<b>E55CAL12T110E</b>	135819							
						PNP	1 N/O	<b>E55CAL12T111E</b>	135821							
						NPN	1 NC	<b>E55CBL12T110E</b>	135836							
			5	Flush	NPN	1 N/O	<b>E55CAL12T111E</b>	135838								
					PNP	1 NC	<b>E55CBL12T111E</b>	135838								
					5	Flush	NPN	1 N/O	<b>E55CAL18T110</b>		135824					
							PNP	1 N/O	<b>E55CAL18T111</b>		135826					
							NPN	1 NC	<b>E55CBL18T110</b>		135841					
					8	Non-flush	NPN	1 N/O	<b>E55CAL18T110E</b>		135825					
PNP	1 N/O	<b>E55CAL18T111E</b>	135827													
NPN	1 NC	<b>E55CBL18T110E</b>	135842													
PNP	1 NC	<b>E55CBL18T111E</b>	135843													
<b>3-wire</b> 2 m connection cable Insulated material																
	M30 x 1.5	10 - 30 V DC	10	Flush			NPN	1 N/O	<b>E55CAL30T110</b>	135830		1 off				
					PNP	1 N/O	<b>E55CAL30T111</b>	135832								
					NPN	1 NC	<b>E55CBL30T110</b>	135846								
				15	Non-flush	NPN	1 NC	<b>E55CBL30T111</b>	135848							
						NPN	1 N/O	<b>E55CAL30T110E</b>	135831							
						PNP	1 N/O	<b>E55CAL30T111E</b>	135833							
			40	Flush	NPN	1 NC	<b>E55CBL30T110E</b>	135847								
					PNP	1 NC	<b>E55CBL30T111E</b>	135849								
					<b>2-wire</b> Screw terminal Insulated material											
						40 x 40 x 118	35 - 250 V AC	15	Flush	-	1 P		<b>E55BLT1C</b>	135812		1 off
									Non-flush	-	1 P		<b>E55BLT1D</b>	135813		
								30	-	1 P	<b>E55BLT1E</b>		135814			
40	-	1 P	<b>E55BLT1F</b>	135815												



Technical data

		E55C...L12A	E55C...L18A	E55C...L30A	E55C...L12T E55C...L12T...E
<b>General</b>					
Standards		IEC/EN 60947-5-2			
Ambient temperature	°C	- 25 - + 70	- 25 - + 70	- 25 - + 70	- 25 - + 70
Protection type		IP66	IP66	IP66	IP66
Mechanical shock resistance	g	30 Shock duration 11 ms			
<b>Characteristics</b>					
Repetition accuracy of S <sub>n</sub>	%	10	10	10	10
Temperature drift of S <sub>n</sub>	%	10	10	10	10
Switching hysteresis of S <sub>n</sub>	%	20	20	20	20
Rated operational voltage	U <sub>e</sub>	20 - 250 V AC	20 - 250 V AC	20 - 250 V AC	10 - 30 V DC
Residual ripple of U <sub>e</sub>	%	10	10	10	10
Maximum load current	I <sub>e</sub> mA	150	150	150	200
Voltage drop at I <sub>e</sub>	U <sub>d</sub> V	10	10	10	8
Switching Frequency	Hz	25	25	25	2000 1000
Switching state display	LED	Red	Red	Red	Red
Protective functions					Short-circuit protective device Protection against polarity reversal
Connection		2-wire	2-wire	2-wire	3-wire
Style					
Design (outer dimensions)	mm	M12 x 1	M18 x 1	M30 x 1.5	M12 x 1
For connection of:		2 m connection cable			
Material		Insulated material			

		E55C...L18T E55C...L18T...E	E55C...L30T E55C...L30T...E	E55BLT...
<b>General</b>				
Standards		IEC/EN 60947-5-2		
Ambient temperature	°C	- 25 - + 70	- 25 - + 70	- 25 - + 70
Protection type		IP66	IP66	IP67
Mechanical shock resistance	g	30 Shock duration 11 ms		
<b>Characteristics</b>				
Repetition accuracy of S <sub>n</sub>	%	10	10	10
Temperature drift of S <sub>n</sub>	%	10	10	10
Switching hysteresis of S <sub>n</sub>	%	20	20	20
Rated operational voltage	U <sub>e</sub>	10 - 30 V DC	10 - 30 V DC	35 - 250 V AC
Residual ripple of U <sub>e</sub>	%	10	10	10
Maximum load current	I <sub>e</sub> mA	200	200	400
Voltage drop at I <sub>e</sub>	U <sub>d</sub> V	8	8	8
Switching Frequency	Hz	1000 500	300 150	25
Switching state display	LED	Red	Red	Red
Protective functions		Short-circuit protective device Protection against polarity reversal	Short-circuit protective device Protection against polarity reversal	Short-circuit protective device
Connection		3-wire	3-wire	2-wire
Style				
Design (outer dimensions)	mm	M18 x 1	M30 x 1.5	40 x 40 x 118
For connection of:		2 m connection cable	2 m connection cable	Screw terminal
Material		Insulated material	Insulated material	Insulated material

**Notes** Further technical data can be found in the Online Catalog at <http://de.ecat.moeller.net>

Engineering

E55CAL...A2, E55CBL...A2  
E55CAL...A2E, E55CBL...A2E

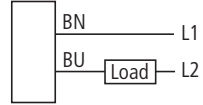

E55BL...

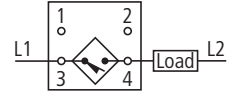

E55CAL...110, E55CBL...110  
E55CAL...110E, E55CBL...110E

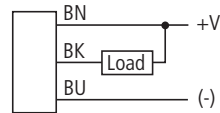

E55BL...

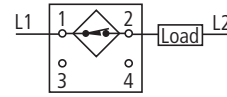

E55CAL...111, E55CBL...111E  
E55CAL...111, E55CBL...111E

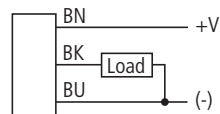

**Note:**  
Switches are supplied configured as N/O. Can be built-in changed over to NC.

Dimensions

E55CAL12...  
E55CBL12...

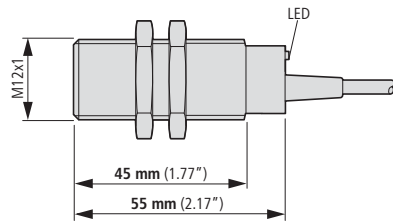

E55BL...

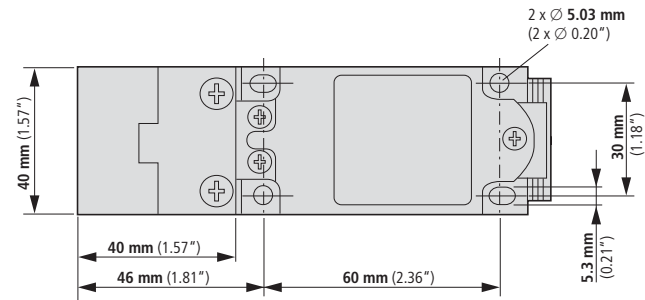

E55CAL18...  
E55CBL18...

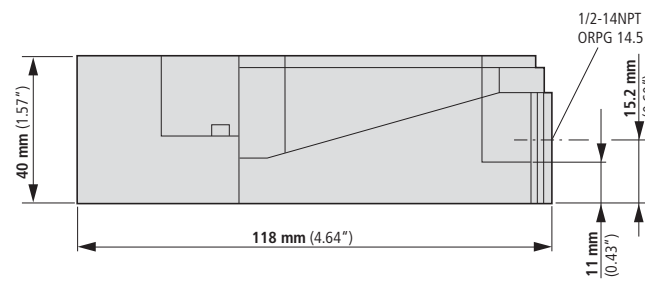
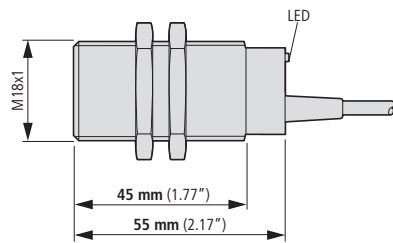

E55CAL30...  
E55CBL30...

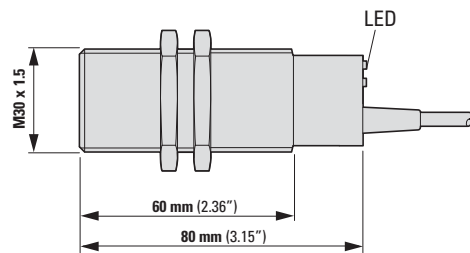

**Description**



① Indicator lights for current and output status.

**Short Description**

Eaton's E56 sensors are powerful inductive proximity sensors. The E56 Pancake provides greater sensing ranges than other inductive sensor package types. They are easy to wire and feature self-configuring complementary outputs, which automatically detect an NPN or PNP connection and configure the sensor accordingly without user interaction. Indicator lights for power and output state simplify troubleshooting compared to sensors with only an output indicator. These convenience features and their high performance make the E56 Pancake sensors ideal for applications in which a rugged design and a long range are required.

**Product Features**

- Large measuring with range up to 100 mm.
- Three sizes for all application scenarios; max. range 50, 70 or 100 mm.
- Complementary outputs (1 × N/C, 1 × N/O) on models with four-wire connection.
- Models with DC voltage four-wire connection feature an automatic configuration function for independent switchover between NPN and PNP.
- Robust design featuring vibration and impact-absorbing potting compound
- Ideal for extreme temperatures or high pressure washdown environments.

**Approvals**



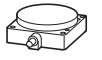
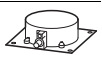

Ordering

	Con- nection	Design (outer dimensions)  mm	Rated operational voltage  U <sub>e</sub>	Rated switching distance  S <sub>n</sub> mm	Type of moun- -ting	Switch- -ing type	For connection of:	Contact configuration N/O = normally open contact N/C = normally closed contact	Part no. Article no.	Price see price list	Std. pack
<b>E56-Serie</b>											
Insulated material											
	4-wire	79 x 79 x 39	10 – 42 V DC	40	Flush	NPN	Plug-in connection M12 x 1	1 NC/1 N/O	<b>E56ADL40SAD01</b> 136234		1 off
		79 x 79 x 39		40	Non- flush	NPN		1 NC/1 N/O			
		109 x 110 x 41		70	Non- flush	NPN		1 NC/1 N/O	<b>E56BDL70UAD01</b> 136236		
		171.5 x 171.5 x 67.4		100	Non- flush	NPN		1 NC/1 N/O			

Information relevant for export to North America

	Product Standards	UL 508; CSA-C22.2 No. 14; IEC60947-5-2; CE marking
	UL File No.	E166051
	UL CCN	NRKH, NRKH7
	CSA File No.	UL report applies to both Canada and US
	CSA Class No.	-
	NA Certification	UL listed, certified by UL for use in Canada
	Max. Voltage Rating	48 V DC
	Degree of Protection	IEC: IP67, IP69K; UL/CSA Type: 4, 4x, 6, 6P, 12, 13

Engineering

Circuit diagrams

E56...

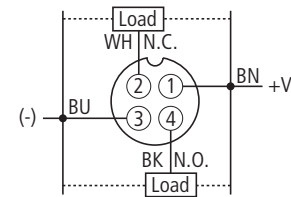

Through autoconfiguration connectable to both +V or (-).

Dimensions

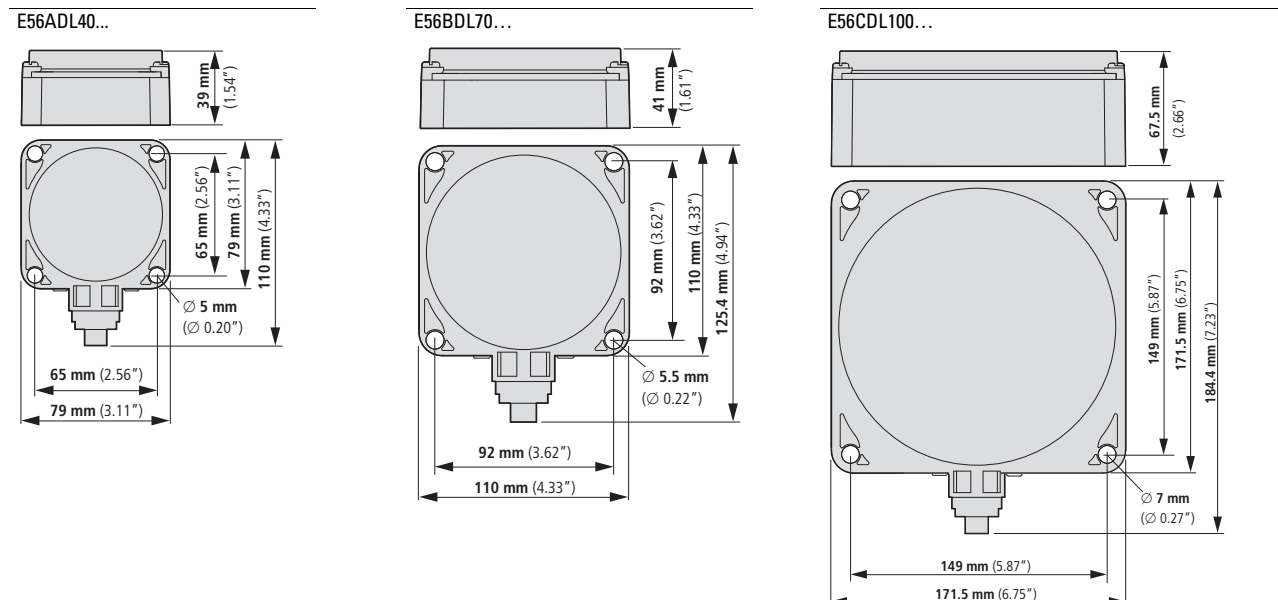

Technical data

			E56ADL40S	E56ADL40U	E56BDL70U	E56CDL100U
<b>General</b>						
Standards			IEC/EN 60947-5-2			
Ambient temperature	°C		- 25 - + 70	- 25 - + 70	- 25 - + 70	- 25 - + 70
Protection type			IP67	IP67	IP67	IP67
<b>Characteristics</b>						
Repetition accuracy of $S_n$	%		2	2	2	2
Temperature drift of $S_n$	%		10	10	10	10
Switching hysteresis of $S_n$	%		15	15	15	15
Rated operational voltage	$U_e$		10 – 42 V DC	10 – 42 V DC	10 – 42 V DC	10 – 42 V DC
Operating current in the switched state at 24 V DC	$I_b$	mA	25	25	25	25
Maximum load current	$I_e$	mA	300	300	300	300
Voltage drop at $I_e$	$U_d$	V	2.5	2.5	2.5	2.5
Switching Frequency		Hz	100	100	20	20
Min. load current	$I_e$	mA	1	1	1	1
Residual current through the load in the blocked state at 230 V AC and 24 V DC	$I_r$	mA	0.15	0.15	0.15	0.15
Switching state display	LED		Red	Red	Red	Red
Operating voltage display	LED		Green	Green	Green	Green
Protective functions			Short-circuit protective device Protection against polarity reversal			
Connection			4-wire	4-wire	4-wire	4-wire
Style						
Design (outer dimensions)	mm		79 x 79 x 39	79 x 79 x 39	109 x 110 x 41	171.5 x 171.5 x 67.4
For connection of:			Plug-in connection M12 x 1			
Material			Insulated material	Insulated material	Insulated material	Insulated material
Surface			PPS	PPS	PPS	PPS

**Notes** Further technical data can be found in the Online Catalog at <http://de.ecat.moeller.net>

## Description



- ① Outputs with function display on all models.  
 ② All models with M12 plug connector or cable (2 m).  
 ③ Versions for flush or non-flush mounting available.

## Short Description

Eaton's proximity sensors of the Global series have been developed specially for OEM series production. The sensors feature only the functions required for reliable operation. This means that you do not pay for additional, unnecessary functions but get the performance and features you expect from a sensor. Our DC versions feature a short-circuit protective device and a rating of up to 2000 measuring cycles per second. The outputs of all models are equipped with a function display. The Global model series includes models with various diameters from 8 to 30 mm, making it truly versatile in installation. Versions with various ranges are also available. The proximity sensors Global are DC or AC units with 2- or 3-wire, NPN or PNP configuration. Versions for hard-wiring or with M12 plug connector are available. The DC versions have a rated load current of 100 mA, the AC versions of 200 mA.

## Product Features

- The Global Proximity Line features solid performance and a basic feature set for reliable, cost-effective sensing.
- Available in a variety of sizes to fit in all of your applications: 8 mm, 12 mm, 18 mm and 30 mm diameters.
- The input voltage of the DC versions is 10 – 30 V DC in 2- and 3-wire configuration (PNP and NPN).
- The input voltage of the AC voltage variants is 2-AC 20...250 V.
- The operating frequency of the DC versions is 2 kHz.
- Versions for flush or non-flush installation available.
- Connection through cable (2 meters) or M12 plug connector
- The DC versions feature a short-circuit protective device.







## Approvals



cCSAus



Ordering







	Rated operational voltage U <sub>e</sub>	Rated switching distance S <sub>n</sub> mm	Type of mounting	Switching type	For connection of:	Contact configuration N/O = normally open contact N/C = normally closed contact	Part no. Article no.	Price see price list	Std. pack
<b>E57 Global series</b>									
2-wire Metal									
M12 x 1									
	10 - 30 V DC	2	Flush	-	2 m connection cable	1 N/O	<b>E57-12GS02-D</b> 135883		1 off  
					Plug-in connection M12 x 1	1 N/O	<b>E57-12GS02-DOB</b> 135884		
		4	Non-flush	2 m connection cable	1 N/O	<b>E57-12GU04-D</b> 135891			
				2 m connection cable	1 NC	<b>E57-12GU04-D1</b> 135892			
			Plug-in connection M12 x 1	1 N/O	<b>E57-12GU04-DOB</b> 135893				
				1 NC	<b>E57-12GE08-D1</b> 135872				
	20 - 250 V AC	2	Flush	-	2 m connection cable	1 N/O	<b>E57-12GS02-A</b> 135879		
					Plug-in connection M12 x 1	1 N/O	<b>E57-12GS02-AAB</b> 135880		
		4	Non-flush	2 m connection cable	1 N/O	<b>E57-12GU04-A</b> 135887			
				Plug-in connection M12 x 1	1 N/O	<b>E57-12GU04-AAB</b> 135888			
			2 m connection cable	1 N/O	<b>E57-12GE08-D</b> 135871				
				1 NC	<b>E57-12GE08-D1DB</b> 135873				
	10 - 30 V DC	5	Flush	-	2 m connection cable	1 N/O	<b>E57-18GS05-D</b> 135929	1 off  	
					Plug-in connection M12 x 1	1 N/O	<b>E57-18GS05-DOB</b> 135930		
		8	Non-flush	2 m connection cable	1 N/O	<b>E57-18GU08-D</b> 135937			
				Plug-in connection M12 x 1	1 N/O	<b>E57-18GU08-DOB</b> 135938			
			16	Non-flush	2 m connection cable	1 N/O	<b>E57-18GE16-D</b> 135917		
					2 m connection cable	1 NC	<b>E57-18GE16-D1</b> 135918		
	20 - 250 V AC	5	Flush	-	2 m connection cable	1 N/O	<b>E57-18GS05-A</b> 135925		
					Plug-in connection M12 x 1	1 N/O	<b>E57-18GS05-AAB</b> 135926		
		8	Non-flush	2 m connection cable	1 N/O	<b>E57-18GU08-A</b> 135933			
				Plug-in connection M12 x 1	1 N/O	<b>E57-18GU08-AAB</b> 135934			
			16	Non-flush	2 m connection cable	1 N/O	<b>E57-18GE16-A</b> 135916		
					Plug-in connection M12 x 1	1 N/O	<b>E57-18GE16-AAB</b> 135916		

Information relevant for export to North America



Product Standards  
UL File No.  
UL CCN  
CSA File No.  
CSA Class No.  
NA Certification  
Max. Voltage Rating  
Degree of Protection

UL 508; CSA-C22.2 No. 14; IEC60947-5-2; CE marking  
CSA report applies to both Canada and US  
-  
224447  
4652-04 / 4652-84  
CSA certified  
250 V AC, 30 V DC  
IEC: IP67, IP69K; UL/CSA Type: -









Rated operational voltage $U_e$	Rated switching distance $S_n$ mm	Type of mounting	Switching type	For connection of:	Contact configuration N/O = normally open contact N/C = normally closed contact	Part no. Article no.	Price see price list	Std. pack
<b>E57 Global series</b>								
<b>2-wire Metal</b>								
<b>M30 x 1.5</b>								
	10 - 30 V DC	10	Flush	-	2 m connection cable	1 N/O	<b>E57-30GS10-D</b> 135973	1 off  
					2 m connection cable	1 NC	<b>E57-30GS10-D1</b> 135974	
					Plug-in connection M12 x 1	1 N/C	<b>E57-30GS10-D1DB</b> 135975	
		Plug-in connection M12 x 1	1 N/O	<b>E57-30GS10-DDB</b> 135976				
		15	Non-flush	2 m connection cable	1 N/O	<b>E57-30GU15-D</b> 135983		
		Plug-in connection M12 x 1		1 N/O	<b>E57-30GU15-DDB</b> 135984			
	20 - 250 V AC	10	Flush	-	2 m connection cable	1 N/O	<b>E57-30GS10-A</b> 135969	
					Plug-in connection M12 x 1	1 N/O	<b>E57-30GS10-AAB</b> 135970	
					15	Non-flush	2 m connection cable	
		2 m connection cable	1 N/C	<b>E57-30GE25-D</b> 135961				
		Plug-in connection M12 x 1	1 N/C	<b>E57-30GE25-D1</b> 135962				
		Plug-in connection M12 x 1	1 N/O	<b>E57-30GE25-DDB</b> 135963				
Plug-in connection M12 x 1	1 N/O	<b>E57-30GE25-DDB</b> 135964						
<b>3-wire Stainless steel</b>								
<b>M8 x 1</b>								
	10 - 30 V DC	1	Flush	NPN	2 m connection cable	1 N/O	<b>E57-08GS01-C</b> 135859	1 off  
					Plug-in connection M12 x 1	1 N/O	<b>E57-08GS01-CDB</b> 135860	
					2 m connection cable	1 N/O	<b>E57-08GS01-G</b> 135861	
		Plug-in connection M12 x 1	1 N/O	<b>E57-08GS01-GDB</b> 135862				
		2	Non-flush	NPN	2 m connection cable	1 N/O	<b>E57-08GU02-C</b> 135863	
					Plug-in connection M12 x 1	1 N/O	<b>E57-08GU02-CDB</b> 135864	
	2 m connection cable				1 N/O	<b>E57-08GU02-G</b> 135865		
	Plug-in connection M12 x 1	1 N/O	<b>E57-08GU02-GDB</b> 135866					
	3	Flush	NPN	2 m connection cable	1 NC	<b>E57-08GBE03-C</b> 135850		
				2 m connection cable	1 N/O	<b>E57-08GE03-C</b> 135851		
				Plug-in connection M12 x 1	1 N/O	<b>E57-08GE03-CDB</b> 135852		
				PNP	2 m connection cable	1 N/O	<b>E57-08GE03-G</b> 135853	
Plug-in connection M12 x 1					1 N/O	<b>E57-08GE03-GDB</b> 135854		

Information relevant for export to North America



Product Standards  
UL File No.  
UL CCN  
CSA File No.  
CSA Class No.  
NA Certification  
Max. Voltage Rating  
Degree of Protection

UL 508; CSA-C22.2 No. 14; IEC60947-5-2; CE marking  
CSA report applies to both Canada and US  
-  
224447  
4652-04 / 4652-84  
CSA certified  
250 V AC, 30 V DC  
IEC: IP67, IP69K; UL/CSA Type: -

	Rated operational voltage $U_e$	Rated switching distance $S_n$ mm	Type of mounting	Switching type	For connection of:	Contact configuration N/O = normally open contact N/C = normally closed contact	Part no. Article no.	Price see price list	Std. pack	
<b>E57 Global series</b>										
<b>3-wire</b>										
<b>M8 x 1, Stainless steel</b>										
	10 - 30 V DC	6	Non-flush	NPN	2 m connection cable	1 N/O	<b>E57-08GE06-C</b> 135855		1 off  	
					Plug-in connection M12 x 1	1 N/O	<b>E57-08GE06-CDB</b> 135856			
				PNP	2 m connection cable	1 N/O	<b>E57-08GE06-G</b> 135857			
					Plug-in connection M12 x 1	1 N/O	<b>E57-08GE06-GDB</b> 135858			
<b>M12 x 1, Metal</b>										
	10 - 30 V DC	2	Flush	NPN	2 m connection cable	1 N/O	<b>E57-12GS02-C</b> 135881		1 off  	
					Plug-in connection M12 x 1	1 N/O	<b>E57-12GS02-CDB</b> 135882			
				PNP	2 m connection cable	1 N/O	<b>E57-12GS02-G</b> 135885			
					Plug-in connection M12 x 1	1 N/O	<b>E57-12GS02-GDB</b> 135886			
				4	NPN	2 m connection cable	1 N/O			<b>E57-12GU04-C</b> 135889
						Plug-in connection M12 x 1	1 N/O			<b>E57-12GU04-CDB</b> 135890
					PNP	2 m connection cable	1 N/O			<b>E57-12GU04-G</b> 135894
						Plug-in connection M12 x 1	1 N/O			<b>E57-12GU04-GDB</b> 135895
		5	NPN	2 m connection cable	1 N/O	<b>E57-12GE05-C</b> 135867				
				Plug-in connection M12 x 1	1 N/O	<b>E57-12GE05-CDB</b> 135868				
			PNP	2 m connection cable	1 N/O	<b>E57-12GE05-G</b> 135869				
				Plug-in connection M12 x 1	1 N/O	<b>E57-12GE05-GDB</b> 135870				
		10	NPN	2 m connection cable	1 N/O	<b>E57-12GE10-C</b> 135875				
				Plug-in connection M12 x 1	1 N/O	<b>E57-12GE10-CDB</b> 135876				
			PNP	2 m connection cable	1 N/O	<b>E57-12GE10-G</b> 135877				
				Plug-in connection M12 x 1	1 N/O	<b>E57-12GE10-GDB</b> 135878				
<b>M18 x 1, Metal</b>										
	10 - 30 V DC	5	Flush	NPN	2 m connection cable	1 N/O	<b>E57-18GS05-C</b> 135927		1 off  	
					Plug-in connection M12 x 1	1 N/O	<b>E57-18GS05-CDB</b> 135928			
				PNP	2 m connection cable	1 N/O	<b>E57-18GS05-G</b> 135931			
					Plug-in connection M12 x 1	1 N/O	<b>E57-18GS05-GDB</b> 135932			
		8	NPN	2 m connection cable	1 N/O	<b>E57-18GE08-C</b> 135912				
				Plug-in connection M12 x 1	1 N/O	<b>E57-18GE08-CDB</b> 135913				
			PNP	2 m connection cable	1 N/O	<b>E57-18GE08-G</b> 135914				
				Plug-in connection M12 x 1	1 N/O	<b>E57-18GE08-GDB</b> 135915				















Information relevant for export to North America



Product Standards  
UL File No.  
UL CCN  
CSA File No.  
CSA Class No.  
NA Certification  
Max. Voltage Rating  
Degree of Protection

UL 508; CSA-C22.2 No. 14; IEC60947-5-2; CE marking  
CSA report applies to both Canada and US  
224447  
4652-04 / 4652-84  
CSA certified  
250 V AC, 30 V DC  
IEC: IP67, IP69K; UL/CSA Type: -



Rated operational voltage $U_e$	Rated switching distance $S_n$ mm	Type of mounting	Switching type	For connection of:	Contact configuration N/O = normally open contact N/C = normally closed contact	Part no. Article no.	Price see price list	Std. pack		
<b>E57 Global series</b>										
<b>3-wire</b>										
<b>M18 x 1 Metal</b>										
	10 - 30 V DC	8	Non-flush	NPN	2 m connection cable	1 N/O	<b>E57-18GU08-C</b> 135935	1 off  		
					Plug-in connection M12 x 1	1 N/O	<b>E57-18GU08-CDB</b> 135936			
				PNP	2 m connection cable	1 N/O	<b>E57-18GU08-G</b> 135939			
					Plug-in connection M12 x 1	1 N/O	<b>E57-18GU08-GDB</b> 135940			
	18	Non-flush	NPN	2 m connection cable	1 N/O	<b>E57-18GE18-C</b> 135921	1 off  			
				Plug-in connection M12 x 1	1 N/O	<b>E57-18GE18-CDB</b> 135922				
			PNP	2 m connection cable	1 N/O	<b>E57-18GE18-G</b> 135923				
				Plug-in connection M12 x 1	1 N/O	<b>E57-18GE18-GDB</b> 135924				
<b>3-wire</b>										
<b>M30 x 1.5 Metal</b>										
	10 - 30 V DC	10	Flush	NPN	2 m connection cable	1 N/O		<b>E57-30GS10-C</b> 135971	1 off  	
					Plug-in connection M12 x 1	1 N/O		<b>E57-30GS10-CDB</b> 135972		
				PNP	2 m connection cable	1 N/O	<b>E57-30GS10-G</b> 135977			
					Plug-in connection M12 x 1	1 N/O	<b>E57-30GS10-GDB</b> 135978			
		15	Flush	NPN	2 m connection cable	1 N/O	<b>E57-30GE15-C</b> 135957	1 off  		
					Plug-in connection M12 x 1	1 N/O	<b>E57-30GE15-CDB</b> 135958			
				PNP	2 m connection cable	1 N/O	<b>E57-30GE15-G</b> 135959			
					Plug-in connection M12 x 1	1 N/O	<b>E57-30GE15-GDB</b> 135960			
	29	Non-flush	NPN	2 m connection cable	1 N/O	<b>E57-30GU15-C</b> 135981	1 off  			
				Plug-in connection M12 x 1	1 N/O	<b>E57-30GU15-CDB</b> 135982				
			PNP	2 m connection cable	1 N/O	<b>E57-30GU15-G</b> 135985				
				Plug-in connection M12 x 1	1 N/O	<b>E57-30GU15-GDB</b> 135986				
	29	Non-flush	NPN	2 m connection cable	1 N/O	<b>E57-30GE29-C</b> 135965				1 off  
				Plug-in connection M12 x 1	1 N/O	<b>E57-30GE29-CDB</b> 135966				
			PNP	2 m connection cable	1 N/O	<b>E57-30GE29-G</b> 135967				
				Plug-in connection M12 x 1	1 N/O	<b>E57-30GE29-GDB</b> 135968				

Information relevant for export to North America



Product Standards	UL 508; CSA-C22.2 No. 14; IEC60947-5-2; CE marking
UL File No.	CSA report applies to both Canada and US
UL CCN	-
CSA File No.	224447
CSA Class No.	4652-04 / 4652-84
NA Certification	CSA certified
Max. Voltage Rating	250 V AC, 30 V DC
Degree of Protection	IEC: IP67, IP69K; UL/CSA Type: -

Engineering

Circuit diagram

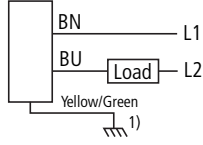
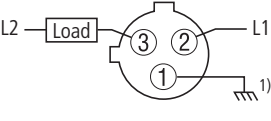
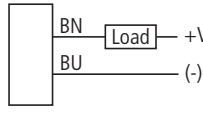
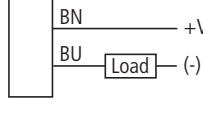
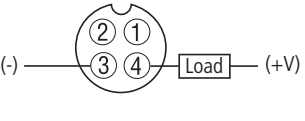
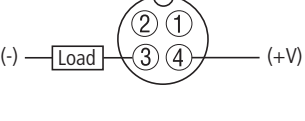
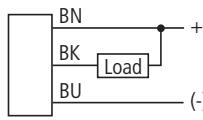
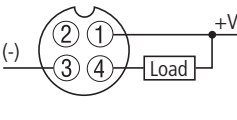
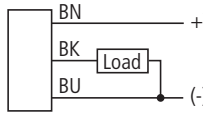
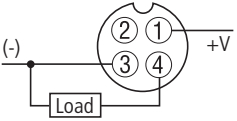
	2 m connection cable	Plug-in connection M12
<b>AC, 2-wire</b>	<p>E57...-A</p>  <p><sup>1)</sup>Built-in connected to enclosure (wiring optional)</p>	<p>E57...-AAB</p>  <p><sup>1)</sup>Built-in connected to enclosure (wiring optional)</p>
<b>DC, 2-wire</b>	<p>E57...-D E57...-D1</p>  	<p>E57...-DDB E57...-D1DB</p>  
<b>DC, 3-wire, NPN</b>	<p>E57...-C</p> 	<p>E57...-CDB</p> 
<b>DC, 3-wire, PNP</b>	<p>E57...-G</p> 	<p>E57...-GDB</p> 

## Technical data

2-wire AC				E57-12...	E57-18...	E57-30...
<b>General</b>						
Standards				IEC/EN 60947-5-2		
Ambient temperature		°C		- 25 - + 70	- 25 - + 70	- 25 - + 70
Protection type				IP67, IP69K	IP67, IP69K	IP67, IP69K
Mechanical shock resistance		g		30 Shock duration 11 ms		
<b>Characteristics</b>						
Repetition accuracy of $S_n$						
	...GS...	%		1	1	1
	...GU...	%		3	3	3
Temperature drift of $S_n$		%		10	10	10
Switching hysteresis of $S_n$		%		15	15	15
Rated operational voltage		$U_e$		20 - 250 V AC	20 - 250 V AC	20 - 250 V AC
Operating current in the switched state at 24 V DC		$I_b$	mA	1.8	1.8	1.8
Maximum load current		$I_e$	mA	< 200	< 200	< 200
Voltage drop at $I_e$		$U_d$	V	8	8	8
Switching Frequency			Hz	25	25	25
Min. load current		$I_e$	mA	5	-	5
Residual current through the load in the blocked state at 230 V AC and 24 V DC		$I_r$	mA	0.01	0.01	0.01
Switching state display			LED	Red	Red	Red
Connection				2-wire	2-wire	2-wire
Design (outer dimensions)			mm	M12 x 1	M18 x 1	M30 x 1.5
Material				Metal	Metal	Metal

2-wire DC				E57-12...	E57-18...	E57-30...
<b>General</b>						
Standards				IEC/EN 60947-5-2		
Ambient temperature						
	...GS...	°C		- 25 - + 70	- 25 - + 70	- 25 - + 70
	...GU...	°C		- 25 - + 70	- 25 - + 70	- 25 - + 70
	...GE...	°C		- 0 - + 60	- 0 - + 60	- 0 - + 60
Protection type				IP67, IP69K	IP67, IP69K	IP67, IP69K
Mechanical shock resistance		g		30 Shock duration 11 ms		
<b>Characteristics</b>						
Repetition accuracy of $S_n$			%	2	2	2
Temperature drift of $S_n$			%	10	10	10
Switching hysteresis of $S_n$			%	15	15	15
Rated operational voltage		$U_e$		10 - 30 V DC	10 - 30 V DC	10 - 30 V DC
Operating current in the switched state at 24 V DC						
	...GS...	$I_b$	mA	10	10	10
	...GU...	$I_b$	mA	20	20	20
	...GE...	$I_b$	mA	10	10	10
Maximum load current		$I_e$	mA	< 100	< 100	< 100
Voltage drop at $I_e$		$U_d$	V	6	6	6
Switching Frequency			Hz			
	Flush		Hz	1000	1000	500
	Non-flush		Hz	1000	500	200
Min. load current		$I_e$	mA	5	5	5
Residual current through the load in the blocked state at 230 V AC and 24 V DC		$I_r$	mA	0.01	0.01	0.01
Switching state display			LED	Red	Red	Red
Connection				2-wire	2-wire	2-wire
Design (outer dimensions)			mm	M12 x 1	M18 x 1	M30 x 1.5
Material				Metal	Metal	Metal

## Notes

Further technical data can be found in the Online Catalog at <http://de.ecat.moeller.net>



3-wire DC				E57-08...	E57-12...	E57-18...	E57-30...
<b>General</b>							
Standards				IEC/EN 60947-5-2			
Ambient temperature							
	...GS...	°C		- 25 - + 70	- 25 - + 70	- 25 - + 70	- 25 - + 70
	...GU...	°C		- 25 - + 70	- 25 - + 70	- 25 - + 70	- 25 - + 70
	...GB...	°C		- 25 - + 70	-	-	-
	...GE...	°C		- 0 - + 60	- 0 - + 60	- 0 - + 60	- 0 - + 60
Protection type				IP67, IP69K	IP67, IP69K	IP67, IP69K	IP67, IP69K
Mechanical shock resistance				30 Shock duration 11 ms			
<b>Characteristics</b>							
Repetition accuracy of $S_n$				1	1	1	1
Temperature drift of $S_n$				10	10	10	10
Switching hysteresis of $S_n$				15	15	15	15
Rated operational voltage				10 - 30 V DC	10 - 30 V DC	10 - 30 V DC	10 - 30 V DC
Residual ripple of $U_e$				10	10	10	10
Operating current in the switched state at 24 V DC							
	...GS...	$I_b$	mA	10	10	10	10
	...GU...	$I_b$	mA	10	20	20	20
	...GE...	$I_b$	mA	10	10	10	10
Maximum load current				$I_e$	mA	< 100	< 100
Voltage drop at $I_e$				$U_d$	V	1.5	1.5
Switching Frequency							
	<b>Flush</b>		Hz	2000	2000	1000	500
	<b>Non-flush</b>		Hz	2000	1000	500	200
Residual current through the load in the blocked state at 230 V AC and 24 V DC				$I_r$	mA	0.01	0.01
Switching state display				LED			
Protective functions				Short-circuit protective device Protection against polarity reversal Protection against wire breakage			
Connection				3-wire			
Design (outer dimensions)				mm			
				M8 x 1	M12 x 1	M18 x 1	M30 x 1.5
Material				Stainless steel			
				Metal	Metal	Metal	Metal

Dimensions

2 m connection cable

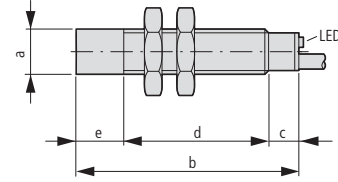

2	Typ	a	b mm (inch)	c mm (inch)	d mm (inch)	e mm (inch)
20 - 250 V AC	E57-12GS02-A	M12 x 1	65 (2.56)	15 (0.59)	50 (1.97)	-
	E57-12GU04-A	M12 x 1	60 (2.36)	15 (0.59)	42 (1.66)	8 (0.31)
	E57-18GS05-A	M18 x 1	80 (3.15)	20 (0.79)	60 (2.36)	-
	E57-18GU08-A	M18 x 1	80 (3.15)	20 (0.79)	48 (1.89)	12 (0.47)
	E57-30GS10-A	M30	80 (3.15)	20 (0.79)	60 (2.36)	-
	E57-30GU15-A	M30	80 (3.15)	20 (0.79)	45 (1.77)	15 (0.59)
10 - 30 V DC	E57-12GS02-D	M12 x 1	50 (1.97)	-	50 (1.97)	-
	E57-12GU04-D	M12 x 1	50 (1.97)	-	42 (1.66)	8 (0.31)
	E57-12GU04-D1	M12 x 1	50 (1.97)	-	42 (1.66)	8 (0.31)
	E57-12GE08-D	M12 x 1	50 (1.97)	-	42 (1.66)	8 (0.31)
	E57-12GE08-D1	M12 x 1	50 (1.97)	-	42 (1.66)	8 (0.31)
	E57-18GS05-D	M18 x 1	55 (2.17)	5 (0.20)	50 (1.97)	-
	E57-18GU08-D	M18 x 1	55 (2.17)	5 (0.20)	38 (1.50)	12 (0.47)
	E57-18GE16-D	M18 x 1	55 (2.17)	5 (0.20)	38 (1.50)	12 (0.47)
	E57-18GE16-D1	M18 x 1	55 (2.17)	5 (0.20)	38 (1.50)	12 (0.47)
	E57-30GS10-D	M30	55 (2.17)	5 (0.20)	50 (1.97)	-
	E57-30GU15-D	M30	55 (2.17)	5 (0.20)	35 (1.38)	15 (0.59)
	E57-30GE25-D	M30	55 (2.17)	5 (0.20)	35 (1.38)	15 (0.59)
	E57-30GE25-D1	M30	55 (2.17)	5 (0.20)	35 (1.38)	15 (0.59)

3	Typ	a	b mm (inch)	c mm (inch)	d mm (inch)	e mm (inch)
10 - 30 V DC	E57-08GE03-C	M8 x 1	46 (1.81)	6 (0.24)	40 (1.57)	-
	E57-08GE06-C	M8 x 1	46 (1.81)	1 (0.04)	41 (1.61)	4 (0.16)
	E57-08GE03-G	M8 x 1	46 (1.81)	6 (0.24)	40 (1.57)	-
	E57-08GE06-G	M8 x 1	46 (1.81)	1 (0.04)	41 (1.61)	4 (0.16)
	E57-08GS01-C	M8 x 1	45 (1.77)	-	45 (1.77)	-
	E57-08GS01-G	M8 x 1	45 (1.77)	-	45 (1.77)	-
	E57-08GU02-C	M8 x 1	45 (1.77)	-	41 (1.61)	4 (0.16)
	E57-08GU02-G	M8 x 1	45 (1.77)	-	41 (1.61)	4 (0.16)
	E57-12GE05-C	M12 x 1	51 (2.00)	2 (0.08)	49 (1.93)	-
	E57-12GE05-G	M12 x 1	51 (2.00)	2 (0.08)	49 (1.93)	-
	E57-12GE10-C	M12 x 1	50.5 (1.99)	1.7 (0.07)	41 (1.61)	7.8 (0.31)
	E57-12GE10-G	M12 x 1	50.5 (1.99)	1.7 (0.07)	41 (1.61)	7.8 (0.31)
	E57-12GS02-C	M12 x 1	50 (1.97)	-	50 (1.97)	-
	E57-12GS02-G	M12 x 1	50 (1.97)	-	50 (1.97)	-
	E57-12GU04-C	M12 x 1	50 (1.97)	-	42 (1.66)	8 (0.31)
	E57-12GU04-G	M12 x 1	50 (1.97)	-	42 (1.66)	8 (0.31)
	E57-18GE08-C	M18 x 1	67.5 (2.66)	2.5 (0.10)	65 (2.56)	-
	E57-18GE08-G	M18 x 1	65.5 (2.58)	2.5 (0.10)	65 (2.56)	-
	E57-18GE18-C	M18 x 1	66 (2.60)	2.5 (0.10)	52 (2.05)	11.5 (0.45)
	E57-18GE18-G	M18 x 1	66 (2.60)	2.5 (0.10)	52 (2.05)	11.5 (0.45)
	E57-18GS05-C	M18 x 1	55 (2.17)	5 (0.20)	50 (1.97)	-
	E57-18GS05-G	M18 x 1	55 (2.17)	5 (0.20)	50 (1.97)	-
	E57-18GU08-C	M18 x 1	55 (2.17)	5 (0.20)	38 (1.50)	12 (0.47)
	E57-18GU08-G	M18 x 1	55 (2.17)	5 (0.20)	38 (1.50)	12 (0.47)
	E57-30GE15-C	M30	69 (2.72)	5 (0.20)	64 (2.52)	-
	E57-30GE15-G	M30	69 (2.72)	5 (0.20)	64 (2.52)	-
	E57-30GE29-C	M30	83 (3.27)	5 (0.20)	64 (2.52)	15 (0.59)
	E57-30GE29-G	M30	83 (3.27)	5 (0.20)	64 (2.52)	15 (0.59)
	E57-30GS10-C	M30	55 (2.17)	5 (0.20)	50 (1.97)	-
	E57-30GS10-G	M30	55 (2.17)	5 (0.20)	50 (1.97)	-
E57-30GU15-C	M30	55 (2.17)	5 (0.20)	35 (1.38)	15 (0.59)	
E57-30GU15-G	M30	55 (2.17)	5 (0.20)	35 (1.38)	15 (0.59)	

Plug-in connection M12 x 1

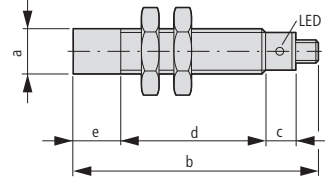

2	Typ	a	b	c	d	e
			mm (inch)	mm (inch)	mm (inch)	mm (inch)
20 - 250 V AC	E57-12GS02-AAB	M12 x 1	68 (2.68)	16 (0.63)	42 (1.66)	-
	E57-12GU04-AAB	M12 x 1	68 (2.68)	16 (0.63)	34 (1.34)	8 (0.31)
	E57-18GE16-AAB	M18 x 1	94 (3.70)	20 (0.79)	48 (1.89)	12 (0.47)
	E57-18GS05-AAB	M18 x 1	91 (3.58)	20 (0.79)	60 (2.36)	-
	E57-18GU08-AAB	M18 x 1	91 (3.58)	20 (0.79)	48 (1.89)	12 (0.47)
	E57-30GS10-AAB	M30	80 (3.15)	20 (0.79)	60 (2.36)	-
10 - 30 V DC	E57-30GU15-AAB	M30	91 (3.58)	20 (0.79)	45 (1.77)	15 (0.59)
	E57-12GS02-DDB	M12 x 1	69 (2.72)	16 (0.63)	42 (1.66)	-
	E57-12GU04-DDB	M12 x 1	68 (2.68)	16 (0.63)	34 (1.34)	8 (0.31)
	E57-12GE08-DDB	M12 x 1	68 (2.68)	16 (0.63)	34 (1.34)	8 (0.31)
	E57-12GE08-D1DB	M12 x 1	68 (2.68)	10 (0.39)	50 (1.97)	8 (0.31)
	E57-18GS05-DDB	M18 x 1	76 (2.99)	15 (0.59)	61 (2.40)	-
	E57-18GU08-DDB	M18 x 1	80 (3.15)	15 (0.59)	49 (1.93)	12 (0.47)
	E57-18GE16-DDB	M18 x 1	79 (3.11)	15 (0.59)	52 (2.05)	12 (0.47)
	E57-18GE16-D1DB	M18 x 1	79 (3.11)	15 (0.59)	52 (2.05)	12 (0.47)
	E57-30GS10-DDB	M30	75 (2.95)	15 (0.59)	60 (2.36)	-
	E57-30GU15-DDB	M30	79 (3.11)	15 (0.59)	45 (1.77)	15 (0.59)
	E57-30GE25-DDB	M30	78 (3.07)	15 (0.59)	48 (1.89)	15 (0.59)
	E57-30GE25-D1DB	M30	78 (3.07)	15 (0.59)	48 (1.89)	15 (0.59)

3	Typ	a	b	c	d	e
			mm (inch)	mm (inch)	mm (inch)	mm (inch)
10 - 30 V DC	E57-08GE03-CDB	M8 x 1	71 (2.80)	26 (1.02)	36 (1.42)	-
	E57-08GE03-CNB	M8 x 1	61 (2.40)	19 (0.75)	42 (1.66)	-
	E57-08GE03-GDB	M8 x 1	71 (2.80)	26 (1.02)	35 (1.38)	-
	E57-08GE03-GNB	M8 x 1	61 (2.40)	19 (0.75)	42 (1.66)	-
	E57-08GE06-CDB	M8 x 1	71 (2.80)	25 (0.98)	31 (1.22)	4 (0.16)
	E57-08GE06-GDB	M8 x 1	71 (2.80)	25 (0.98)	31 (1.22)	4 (0.16)
	E57-08GS01-CDB	M8 x 1	70 (2.76)	21 (0.83)	49 (1.93)	-
	E57-08GS01-GDB	M8 x 1	70 (2.76)	21 (0.83)	49 (1.93)	-
	E57-08GU02-CDB	M8 x 1	70 (2.76)	21 (0.83)	45 (1.77)	4 (0.16)
	E57-08GU02-GDB	M8 x 1	70 (2.76)	21 (0.83)	45 (1.77)	4 (0.16)
	E57-12GE05-CDB	M12 x 1	69 (2.72)	24 (0.94)	45 (1.77)	-
	E57-12GE05-GDB	M12 x 1	69 (2.72)	24 (0.94)	45 (1.77)	-
	E57-12GE10-CDB	M12 x 1	68.5 (2.70)	10.3 (0.41)	36 (1.42)	7.8 (0.31)
	E57-12GE10-GDB	M12 x 1	68.5 (2.70)	10.3 (0.41)	36 (1.42)	7.8 (0.31)
	E57-12GS02-CDB	M12 x 1	68 (2.68)	16 (0.63)	52 (2.05)	-
	E57-12GS02-GDB	M12 x 1	68 (2.68)	16 (0.63)	52 (2.05)	-
	E57-12GU04-CDB	M12 x 1	68 (2.68)	20 (0.79)	31 (1.22)	8 (0.31)
	E57-12GU04-GDB	M12 x 1	68 (2.68)	20 (0.79)	31 (1.22)	8 (0.31)
	E57-18GE08-CDB	M18 x 1	80 (3.15)	6 (0.24)	49 (1.93)	-
	E57-18GE08-GDB	M18 x 1	80 (3.15)	16 (0.63)	49 (1.93)	-
	E57-18GE18-CDB	M18 x 1	79 (3.11)	6 (0.24)	37 (1.46)	12 (0.47)
	E57-18GE18-GDB	M18 x 1	79 (3.11)	6 (0.24)	37 (1.46)	12 (0.47)
	E57-18GS05-CDB	M18 x 1	76 (2.99)	15 (0.59)	61 (2.40)	-
	E57-18GS05-GDB	M18 x 1	76 (2.99)	15 (0.59)	61 (2.40)	-
	E57-18GU08-CDB	M18 x 1	76 (2.99)	15 (0.59)	49 (1.93)	12 (0.47)
	E57-18GU08-GDB	M18 x 1	80 (3.15)	15 (0.59)	49 (1.93)	12 (0.47)
	E57-30GS10-CDB	M30	79 (3.11)	15 (0.59)	60 (2.36)	-
	E57-30GS10-GDB	M30	75 (2.95)	15 (0.59)	60 (2.36)	-
	E57-30GE15-CDB	M30	80 (3.15)	16 (0.63)	49 (1.93)	-
	E57-30GE15-GDB	M30	80 (3.15)	16 (0.63)	49 (1.93)	-
E57-30GE29-CDB	M30	95 (3.74)	16 (0.63)	49 (1.93)	15 (0.59)	
E57-30GE29-GDB	M30	95 (3.74)	16 (0.63)	49 (1.93)	15 (0.59)	
E57-30GU15-CDB	M30	75 (2.95)	15 (0.59)	45 (1.77)	15 (0.59)	
E57-30GU15-GDB	M30	75 (2.95)	15 (0.59)	45 (1.77)	15 (0.59)	

## Description



① Measuring head angled 90° for difficult measuring tasks



## Short Description

Eaton's inductive proximity sensors of the Premium+ series feature an enhanced measuring performance, durability and selection. Unlike the standard sensors, the Premium+ models feature a rugged stainless steel enclosure, impact-resistant front caps and an impact-absorbing sealant. The sensors are now available in versions for AC, AC/DC and DC-only operation, with enclosure diameters of 12, 18 and 30 mm. Their interference immunity is unsurpassed at more than 20 volts/meter. The Premium+ series includes sensors with a specially short, cylindrical enclosure. Despite their small size, they feature the same measuring range as the longer standard sizes. This allows the sensors to be used in applications where mounting space is limited. All sensors are equipped with a LED with 360° visibility.

## Product Features







- New, wider product range – models with two-wire, three-wire, AC, DC and AC/DC connection.
- Resistant against mechanical and environmental strain.
- Designed with stainless steel barrel and new potting compound for robust, high temperature, high pressure washdown, as well as intense shock and vibration applications.
- Unmatched high noise immunity eliminates problems associated with electrical noise (all models > 20 Volt/Meter).
- Output status lamp is visible through 360° from any direction and at all light conditions.
- AC/DC and DC models have resettable short-circuit and polarity reversal protection.
- Models with 90° measuring head offer unique problem-solving capabilities.
- Large temperature range (-25 to 70 °C).
- Small sizes for space-saving installation available.
- Versions with cable for hard wiring or M12 plug connector for fast installation and simple replacement.

## Approvals







Ordering

Rated switching distance $S_n$ mm	Type of mounting	Switching type	For connection of:	Contact configuration N/O = normally open contact N/C = normally closed contact	Part no.	Article no.	Price see price list	Std. pack	
<b>E57 Premium Plus</b>									
2-wire, Stainless steel Rated operational voltage $U_o$ 20 - 250 V AC									
<b>M12 x 1</b>									
	2	Flush	-	2 m connection cable	1 N/O	<b>E57LAL12A2</b> <sup>1)</sup>	135995	1 off  	
			-	Plug-in connection M12 x 1	1 N/O	<b>E57LAL12A2SA</b> <sup>1)</sup>	135998		
			-	2 m connection cable	1 NC	<b>E57LBL12A2</b> <sup>1)</sup>	136030		
			-	Plug-in connection M12 x 1	1 NC	<b>E57LBL12A2SA</b> <sup>1)</sup>	136033		
	4	Non-flush	-	2 m connection cable	1 N/O	<b>E57LAL12A2E</b> <sup>1)</sup>	135996		
			-	Plug-in connection M12 x 1	1 N/O	<b>E57LAL12A2EA</b> <sup>1)</sup>	135997		
			-	2 m connection cable	1 NC	<b>E57LBL12A2E</b> <sup>1)</sup>	136031		
			-	Plug-in connection M12 x 1	1 NC	<b>E57LBL12A2EA</b> <sup>1)</sup>	136032		
<b>M18 x 1</b>									
	5	Flush	-	2 m connection cable	1 N/O	<b>E57LAL18A2</b> <sup>1)</sup>	136007		
			-	2 m connection cable	1 NC	<b>E57LBL18A2</b> <sup>1)</sup>	136042		
			-	Plug-in connection M12 x 1	1 NC	<b>E57LBL18A2SA</b> <sup>1)</sup>	136045		
			-	2 m connection cable	1 N/O	<b>E57RAL18A2</b> <sup>2)</sup>	136066		
		8	Non-flush	-	2 m connection cable	1 N/O	<b>E57LAL18A2E</b> <sup>1)</sup>		136008
				-	Plug-in connection M12 x 1	1 N/O	<b>E57LAL18A2EA</b> <sup>1)</sup>		136009
				-	2 m connection cable	1 NC	<b>E57LBL18A2E</b> <sup>1)</sup>		136043
				-	Plug-in connection M12 x 1	1 NC	<b>E57LBL18A2EA</b> <sup>1)</sup>		136044
	8	Non-flush	-	Plug-in connection M12 x 1	1 N/O	<b>E57RAL18A2EA</b> <sup>2)</sup>	136068		
			-	Plug-in connection M12 x 1	1 NC	<b>E57RBL18A2EA</b> <sup>2)</sup>	136080		
			-	2 m connection cable	1 N/O	<b>E57RAL18A2E</b> <sup>2)</sup>	136067		
			-	2 m connection cable	1 NC	<b>E57RBL18A2E</b> <sup>2)</sup>	136079		
<b>M30 x 1.5</b>									
	10	Flush	-	2 m connection cable	1 N/O	<b>E57LAL30A2</b> <sup>1)</sup>	136018		
			-	Plug-in connection M12 x 1	1 N/O	<b>E57LAL30A2SA</b> <sup>1)</sup>	136021		
			-	2 m connection cable	1 NC	<b>E57LBL30A2</b> <sup>1)</sup>	136054		
			-	Plug-in connection M12 x 1	1 NC	<b>E57LBL30A2SA</b> <sup>1)</sup>	136057		
	15	Non-flush	-	2 m connection cable	1 N/O	<b>E57LAL30A2E</b> <sup>1)</sup>	136019		
			-	Plug-in connection M12 x 1	1 N/O	<b>E57LAL30A2EA</b> <sup>1)</sup>	136020		
			-	2 m connection cable	1 NC	<b>E57LBL30A2E</b> <sup>1)</sup>	136055		
			-	Plug-in connection M12 x 1	1 NC	<b>E57LBL30A2EA</b> <sup>1)</sup>	136056		

Information relevant for export to North America









- |    |                      |   |
|----|----------------------|---|
| 1) | Product Standards    | UL 508; CSA-C22.2 No. 14; IEC60947-5-2; CE marking  |
|    | UL File No.          | E166051   |
|    | UL CCN               | NRKH, NRKH7   |
|    | CSA File No.         | 50513   |
|    | CSA Class No.        | 3211-03   |
|    | NA Certification     | UL listed, CSA certified                            |
|    | Max. Voltage Rating  | 250 V AC  |
|    | Degree of Protection | IEC: IP67, IP69K; UL/CSA Type: 4, 4x, 6, 6P, 12, 13 |
| 2) | Product Standards    | UL 508; IEC60947-5-2; CE marking                    |
|    | UL File No.          | E166051   |
|    | UL CCN               | NRKH, NRKH7   |
|    | NA Certification     | UL listed   |
|    | Max. Voltage Rating  | 250 V AC  |
|    | Degree of Protection | IEC: IP67, IP69K; UL/CSA Type: 4, 4x, 6, 6P, 12, 13 |

Rated switching distance $S_n$ mm	Type of mounting	Switching type	For connection of:	Contact configuration N/O = normally open contact N/C = normally closed contact	Part no.	Article no.	Price see price list	Std. pack
<b>E57 Premium Plus</b>								
3-wire, Stainless steel Rated operational voltage $U_o$ 6 - 48 V DC								
 M12 x 1	2	Flush	NPN	2 m connection cable	1 N/O	<b>E57LAL12T110</b> <sup>2)</sup>	135999	1 off  
				Plug-in connection M12 x 1	1 N/O	<b>E57LAL12T110SD</b> <sup>2)</sup>	136002	
			2 m connection cable	1 NC	<b>E57LBL12T110</b> <sup>2)</sup>	136034		
			Plug-in connection M12 x 1	1 NC	<b>E57LBL12T110SD</b> <sup>2)</sup>	136037		
		PNP	2 m connection cable	1 N/O	<b>E57LAL12T111</b> <sup>2)</sup>	136003		
			Plug-in connection M12 x 1	1 N/O	<b>E57LAL12T111SD</b> <sup>2)</sup>	136006		
			2 m connection cable	1 NC	<b>E57LBL12T111</b> <sup>2)</sup>	136038		
			Plug-in connection M12 x 1	1 NC	<b>E57LBL12T111SD</b> <sup>2)</sup>	136041		
	4	Non-flush	NPN	2 m connection cable	1 N/O	<b>E57LAL12T110E</b> <sup>2)</sup>	136000	1 off
				Plug-in connection M12 x 1	1 N/O	<b>E57LAL12T110ED</b> <sup>2)</sup>	136001	
			2 m connection cable	1 NC	<b>E57LBL12T110E</b> <sup>2)</sup>	136035		
			Plug-in connection M12 x 1	1 NC	<b>E57LBL12T110ED</b> <sup>2)</sup>	136036		
		PNP	2 m connection cable	1 N/O	<b>E57LAL12T111E</b> <sup>2)</sup>	136004		
			Plug-in connection M12 x 1	1 N/O	<b>E57LAL12T111ED</b> <sup>2)</sup>	136005		
			2 m connection cable	1 NC	<b>E57LBL12T111E</b> <sup>2)</sup>	136039		
			Plug-in connection M12 x 1	1 NC	<b>E57LBL12T111ED</b> <sup>2)</sup>	136040		
	6	Semi-flush	PNP	2 m connection cable	1 N/O	<b>E57-12LE06-B</b>	135896	1 off
				2 m connection cable	1 NC	<b>E57-12LE06-B1</b>	135897	
			Plug-in connection M12 x 1	1 NC	<b>E57-12LE06-B1D</b>	135898		
			Plug-in connection M12 x 1	1 N/O	<b>E57-12LE06-BD</b>	135899		
NPN		2 m connection cable	1 N/O	<b>E57-12LE06-C</b>	135900			
		2 m connection cable	1 NC	<b>E57-12LE06-C1</b>	135901			
		Plug-in connection M12 x 1	1 NC	<b>E57-12LE06-C1D</b>	135902			
		Plug-in connection M12 x 1	1 N/O	<b>E57-12LE06-CD</b>	135903			
10	Semi-flush	PNP	2 m connection cable	1 N/O	<b>E57-12LE10-B</b>	135904	1 off	
			2 m connection cable	1 NC	<b>E57-12LE10-B1</b>	135905		
		Plug-in connection M12 x 1	1 NC	<b>E57-12LE10-B1D</b>	135906			
		Plug-in connection M12 x 1	1 N/O	<b>E57-12LE10-BD</b>	135907			
	NPN	2 m connection cable	1 N/O	<b>E57-12LE10-C</b>	135908			
		2 m connection cable	1 NC	<b>E57-12LE10-C1</b>	135909			
		Plug-in connection M12 x 1	1 NC	<b>E57-12LE10-C1D</b>	135910			
		Plug-in connection M12 x 1	1 N/O	<b>E57-12LE10-CD</b>	135911			

Information relevant for export to North America





<sup>2)</sup> Product Standards	UL 508; CSA-C22.2 No. 14; IEC60947-5-2; CE marking
UL File No.	E166051
UL CCN	NRKH, NRKH7
CSA File No.	50513
CSA Class No.	3211-03
NA Certification	UL listed, CSA certified
Max. Voltage Rating	48 V DC
Degree of Protection	IEC: IP67, IP69K; UL/CSA Type: 4, 4x, 6, 6P, 12, 13

Rated switching distance $S_n$ mm	Type of mounting	Switching type	For connection of:	Contact configuration N/O = normally open contact N/C = normally closed contact	Part no.	Article no.	Price see price list	Std. pack
<b>E57 Premium Plus</b>								
3-wire, Stainless steel Rated operational voltage $U_o$ 6 - 48 V DC								
M18 x 1								
	5	Flush	NPN	2 m connection cable	1 N/O	<b>E57LAL18T110</b> <sup>2)</sup>	136010	1 off  
				Plug-in connection M12 x 1	1 N/O	<b>E57LAL18T110SD</b> <sup>2)</sup>	136013	
				2 m connection cable	1 NC	<b>E57LBL18T110</b> <sup>2)</sup>	136046	
				Plug-in connection M12 x 1	1 NC	<b>E57LBL18T110SD</b> <sup>2)</sup>	136049	
			PNP	2 m connection cable	1 N/O	<b>E57LAL18T111</b> <sup>2)</sup>	136014	
				Plug-in connection M12 x 1	1 N/O	<b>E57LAL18T111SD</b> <sup>2)</sup>	136017	
				2 m connection cable	1 NC	<b>E57LBL18T111</b> <sup>2)</sup>	136050	
				Plug-in connection M12 x 1	1 NC	<b>E57LBL18T111SD</b> <sup>2)</sup>	136053	
	5	Flush	NPN	2 m connection cable	1 N/O	<b>E57RAL18T110</b> <sup>1)</sup>	136070	
				Plug-in connection M12 x 1	1 N/O	<b>E57RAL18T110SD</b> <sup>1)</sup>	136073	
				2 m connection cable	1 NC	<b>E57RBL18T110</b> <sup>1)</sup>	136082	
				Plug-in connection M12 x 1	1 NC	<b>E57RBL18T110SD</b> <sup>1)</sup>	136085	
			PNP	2 m connection cable	1 N/O	<b>E57RAL18T111</b> <sup>1)</sup>	136074	
				Plug-in connection M12 x 1	1 N/O	<b>E57RAL18T111SD</b> <sup>1)</sup>	136077	
				2 m connection cable	1 NC	<b>E57RBL18T111</b> <sup>1)</sup>	136086	
				Plug-in connection M12 x 1	1 NC	<b>E57RBL18T111SD</b> <sup>1)</sup>	136089	
	8	Non-flush	NPN	2 m connection cable	1 N/O	<b>E57LAL18T110E</b> <sup>2)</sup>	136011	
				Plug-in connection M12 x 1	1 N/O	<b>E57LAL18T110ED</b> <sup>2)</sup>	136012	
				2 m connection cable	1 NC	<b>E57LBL18T110E</b> <sup>2)</sup>	136047	
				Plug-in connection M12 x 1	1 NC	<b>E57LBL18T110ED</b> <sup>2)</sup>	136048	
			PNP	2 m connection cable	1 N/O	<b>E57LAL18T111E</b> <sup>2)</sup>	136015	
				Plug-in connection M12 x 1	1 N/O	<b>E57LAL18T111ED</b> <sup>2)</sup>	136016	
				2 m connection cable	1 NC	<b>E57LBL18T111E</b> <sup>2)</sup>	136051	
				Plug-in connection M12 x 1	1 NC	<b>E57LBL18T111ED</b> <sup>2)</sup>	136052	
	8	Non-flush	NPN	2 m connection cable	1 N/O	<b>E57RAL18T110E</b> <sup>1)</sup>	136071	
				Plug-in connection M12 x 1	1 N/O	<b>E57RAL18T110ED</b> <sup>1)</sup>	136072	
				2 m connection cable	1 NC	<b>E57RBL18T110E</b> <sup>1)</sup>	136083	
				Plug-in connection M12 x 1	1 NC	<b>E57RBL18T110ED</b> <sup>1)</sup>	136084	
			PNP	2 m connection cable	1 N/O	<b>E57RAL18T111E</b> <sup>1)</sup>	136075	
				Plug-in connection M12 x 1	1 N/O	<b>E57RAL18T111ED</b> <sup>1)</sup>	136076	
				2 m connection cable	1 NC	<b>E57RBL18T111E</b> <sup>1)</sup>	136087	
				Plug-in connection M12 x 1	1 NC	<b>E57RBL18T111ED</b> <sup>1)</sup>	136088	

Information relevant for export to North America



- 1) Product Standards  
UL File No. UL 508; IEC60947-5-2; CE marking  
UL CCN E166051  
NA Certification NRKH, NRKH7  
Max. Voltage Rating UL listed  
Degree of Protection 48 V DC  
IEC: IP67, IP69K; UL/CSA Type: 4, 4x, 6, 6P, 12, 13
- 2) Product Standards  
UL File No. UL 508; CSA-C22.2 No. 14; IEC60947-5-2; CE marking  
UL CCN E166051  
CSA File No. NRKH, NRKH7  
CSA Class No. 50513  
NA Certification 3211-03  
Max. Voltage Rating UL listed, CSA certified  
Degree of Protection 48 V DC  
IEC: IP67, IP69K; UL/CSA Type: 4, 4x, 6, 6P, 12, 13

Rated switching distance $S_n$ mm	Type of mounting	Switching type	For connection of:	Contact configuration N/O = normally open contact N/C = normally closed contact	Part no.	Article no.	Price see price list	Std. pack
<b>E57 Premium Plus</b>								
3-wire, Stainless steel Rated operational voltage $U_o$ 6 - 48 V DC								
M18 x 1								
	12	Semi-flush	PNP	2 m connection cable	1 N/O	<b>E57-18LE12-B</b>	135941	1 off
				2 m connection cable	1 NC	<b>E57-18LE12-B1</b>	135942	
			Plug-in connection M12 x 1	1 NC	<b>E57-18LE12-B1D</b>	135943		
			Plug-in connection M12 x 1	1 N/O	<b>E57-18LE12-BD</b>	135944		
		NPN	2 m connection cable	1 N/O	<b>E57-18LE12-C</b>	135945		
			2 m connection cable	1 NC	<b>E57-18LE12-C1</b>	135946		
			Plug-in connection M12 x 1	1 NC	<b>E57-18LE12-C1D</b>	135947		
			Plug-in connection M12 x 1	1 N/O	<b>E57-18LE12-CD</b>	135948		
	20	Semi-flush	PNP	2 m connection cable	1 N/O	<b>E57-18LE20-B</b>	135949	
				2 m connection cable	1 NC	<b>E57-18LE20-B1</b>	135950	
			Plug-in connection M12 x 1	1 NC	<b>E57-18LE20-B1D</b>	135951		
			Plug-in connection M12 x 1	1 N/O	<b>E57-18LE20-BD</b>	135952		
NPN		2 m connection cable	1 N/O	<b>E57-18LE20-C</b>	135953			
		2 m connection cable	1 NC	<b>E57-18LE20-C1</b>	135954			
		Plug-in connection M12 x 1	1 NC	<b>E57-18LE20-C1D</b>	135955			
		Plug-in connection M12 x 1	1 N/O	<b>E57-18LE20-CD</b>	135956			
M30 x 1.5								
	15	Flush	NPN	2 m connection cable	1 N/O	<b>E57LAL30T110</b> <sup>2)</sup>	136022	1 off 
				Plug-in connection M12 x 1	1 N/O	<b>E57LAL30T110SD</b> <sup>2)</sup>	136025	
				2 m connection cable	1 NC	<b>E57LBL30T110</b> <sup>2)</sup>	136058	
				Plug-in connection M12 x 1	1 NC	<b>E57LBL30T110SD</b> <sup>2)</sup>	136061	
			PNP	2 m connection cable	1 N/O	<b>E57LAL30T111</b> <sup>2)</sup>	136026	
				Plug-in connection M12 x 1	1 N/O	<b>E57LAL30T111SD</b> <sup>2)</sup>	136029	
				2 m connection cable	1 NC	<b>E57LBL30T111</b> <sup>2)</sup>	136062	
				Plug-in connection M12 x 1	1 NC	<b>E57LBL30T111SD</b> <sup>2)</sup>	136065	
		Non-flush	NPN	2 m connection cable	1 N/O	<b>E57LAL30T110E</b> <sup>2)</sup>	136023	
				Plug-in connection M12 x 1	1 N/O	<b>E57LAL30T110ED</b> <sup>2)</sup>	136024	
				2 m connection cable	1 NC	<b>E57LBL30T110E</b> <sup>2)</sup>	136059	
				Plug-in connection M12 x 1	1 NC	<b>E57LBL30T110ED</b> <sup>2)</sup>	136060	
			PNP	2 m connection cable	1 N/O	<b>E57LAL30T111E</b> <sup>2)</sup>	136027	
				Plug-in connection M12 x 1	1 N/O	<b>E57LAL30T111ED</b> <sup>2)</sup>	136028	
				2 m connection cable	1 NC	<b>E57LBL30T111E</b> <sup>2)</sup>	136063	
				Plug-in connection M12 x 1	1 NC	<b>E57LBL30T111ED</b> <sup>2)</sup>	136064	
	22	Semi-flush	PNP	2 m connection cable	1 N/O	<b>E57-30LE22-B</b>	135987	1 off
				2 m connection cable	1 NC	<b>E57-30LE22-B1</b>	135988	
				Plug-in connection M12 x 1	1 NC	<b>E57-30LE22-B1D</b>	135989	
				Plug-in connection M12 x 1	1 N/O	<b>E57-30LE22-BD</b>	135990	
			NPN	2 m connection cable	1 N/O	<b>E57-30LE22-C</b>	135991	
				2 m connection cable	1 NC	<b>E57-30LE22-C1</b>	135992	
				Plug-in connection M12 x 1	1 NC	<b>E57-30LE22-C1D</b>	135993	
				Plug-in connection M12 x 1	1 N/O	<b>E57-30LE22-CD</b>	135994	









Information relevant for export to North America







<sup>2)</sup> Product Standards	UL 508; CSA-C22.2 No. 14; IEC60947-5-2; CE marking
UL File No.	E166051
UL CCN	NRKH, NRKH7
CSA File No.	50513
CSA Class No.	3211-03
NA Certification	UL listed, CSA certified
Max. Voltage Rating	48 V DC
Degree of Protection	IEC: IP67, IP69K; UL/CSA Type: 4, 4x, 6, 6P, 12, 13



Premium Plus Short series E57

Rated switching distance $S_n$ mm	Type of mounting	Switching type	For connection of:	Contact configuration N/O = normally open contact N/C = normally closed contact	Part no.	Article no.	Price see price list	Std. pack
<b>E57-Premium-Plus-Short</b>								
2-wire, Stainless steel								
Rated operational voltage $U_o$ 40 - 250 V AC, 20 - 250 V DC								
<b>M12 x 1</b>								
	2	Flush	-	2 m connection cable	1 N/O	<b>E57SAL12A2</b>	136090	1 off  
			-	Plug-in connection M12 x 1	1 N/O	<b>E57SAL12A2SA</b>	136093	
			-	2 m connection cable	1 NC	<b>E57SBL12A2</b>	136138	
			-	Plug-in connection M12 x 1	1 NC	<b>E57SBL12A2SA</b>	136141	
	4	Non-flush	-	2 m connection cable	1 N/O	<b>E57SAL12A2E</b>	136091	
			-	Plug-in connection M12 x 1	1 N/O	<b>E57SAL12A2EA</b>	136092	
			-	2 m connection cable	1 NC	<b>E57SBL12A2E</b>	136139	
			-	Plug-in connection M12 x 1	1 NC	<b>E57SBL12A2EA</b>	136140	
<b>M18 x 1</b>								
	5	Flush	-	2 m connection cable	1 N/O	<b>E57SAL18A2</b>	136106	
			-	Plug-in connection M12 x 1	1 N/O	<b>E57SAL18A2SA</b>	136109	
			-	2 m connection cable	1 NC	<b>E57SBL18A2</b>	136152	
			-	Plug-in connection M12 x 1	1 NC	<b>E57SBL18A2SA</b>	136155	
	8	Non-flush	-	2 m connection cable	1 N/O	<b>E57SAL18A2E</b>	136107	
			-	Plug-in connection M12 x 1	1 N/O	<b>E57SAL18A2EA</b>	136108	
			-	2 m connection cable	1 NC	<b>E57SBL18A2E</b>	136153	
			-	Plug-in connection M12 x 1	1 NC	<b>E57SBL18A2EA</b>	136154	
<b>M30 x 1.5</b>								
	10	Flush	-	2 m connection cable	1 N/O	<b>E57SAL30A2</b>	136122	
			-	Plug-in connection M12 x 1	1 N/O	<b>E57SAL30A2SA</b>	136125	
			-	2 m connection cable	1 NC	<b>E57SBL30A2</b>	136168	
			-	Plug-in connection M12 x 1	1 NC	<b>E57SBL30A2SA</b>	136171	
	15	Non-flush	-	2 m connection cable	1 N/O	<b>E57SAL30A2E</b>	136123	
			-	Plug-in connection M12 x 1	1 N/O	<b>E57SAL30A2EA</b>	136124	
			-	2 m connection cable	1 NC	<b>E57SBL30A2E</b>	136169	
			-	Plug-in connection M12 x 1	1 NC	<b>E57SBL30A2EA</b>	136170	
Rated operational voltage $U_o$ 40 - 250 V AC								
<b>M12 x 1</b>								
	2	Flush	-	2 m connection cable	1 N/O	<b>E57SAL12A4</b>	136094	
			-	Plug-in connection M12 x 1	1 N/O	<b>E57SAL12A4SA</b>	136097	
			-	2 m connection cable	1 NC	<b>E57SBL12A4</b>	136142	
			-	Plug-in connection M12 x 1	1 NC	<b>E57SBL12A4SA</b>	136145	
	4	Non-flush	-	2 m connection cable	1 N/O	<b>E57SAL12A4E</b>	136095	
			-	Plug-in connection M12 x 1	1 N/O	<b>E57SAL12A4EA</b>	136096	
			-	2 m connection cable	1 NC	<b>E57SBL12A4E</b>	136143	
			-	Plug-in connection M12 x 1	1 NC	<b>E57SBL12A4EA</b>	136144	
<b>M18 x 1</b>								
	5	Flush	-	2 m connection cable	1 N/O	<b>E57SAL18A4</b>	136110	
			-	Plug-in connection M12 x 1	1 N/O	<b>E57SAL18A4SA</b>	136113	
			-	2 m connection cable	1 NC	<b>E57SBL18A4</b>	136156	
			-	Plug-in connection M12 x 1	1 NC	<b>E57SBL18A4SA</b>	136159	
	8	Non-flush	-	2 m connection cable	1 N/O	<b>E57SAL18A4E</b>	136111	
			-	Plug-in connection M12 x 1	1 N/O	<b>E57SAL18A4EA</b>	136112	
			-	2 m connection cable	1 NC	<b>E57SBL18A4E</b>	136157	
			-	Plug-in connection M12 x 1	1 NC	<b>E57SBL18A4EA</b>	136158	
<b>M30 x 1.5</b>								
	10	Flush	-	2 m connection cable	1 N/O	<b>E57SAL30A4</b>	136126	
			-	Plug-in connection M12 x 1	1 N/O	<b>E57SAL30A4SA</b>	136129	
			-	2 m connection cable	1 NC	<b>E57SBL30A4</b>	136172	
			-	Plug-in connection M12 x 1	1 NC	<b>E57SBL30A4SA</b>	136175	
	15	Non-flush	-	2 m connection cable	1 N/O	<b>E57SAL30A4E</b>	136127	
			-	Plug-in connection M12 x 1	1 N/O	<b>E57SAL30A4EA</b>	136128	
			-	2 m connection cable	1 NC	<b>E57SBL30A4E</b>	136173	
			-	Plug-in connection M12 x 1	1 NC	<b>E57SBL30A4EA</b>	136174	

Rated switching distance $S_n$ mm	Type of mounting	Switching type	For connection of:	Contact configuration N/O = normally open contact N/C = normally closed contact	Part no.	Article no.	Price see price list	Std. pack			
<b>E57-Premium-Plus-Short</b>											
3-wire, Stainless steel											
Rated operational voltage $U_o$ , 6 - 48 V DC											
M12 x 1											
	2	Flush	NPN	2 m connection cable	1 N/O	<b>E57SAL12T110</b>	136098	1 off  			
			NPN	Plug-in connection M12 x 1	1 N/O	<b>E57SAL12T110SD</b>	136101				
			PNP	2 m connection cable	1 N/O	<b>E57SAL12T111</b>	136102				
			PNP	Plug-in connection M12 x 1	1 N/O	<b>E57SAL12T111SD</b>	136105				
			PNP	2 m connection cable	1 NC	<b>E57SBL12T111</b>	136148				
			PNP	Plug-in connection M12 x 1	1 NC	<b>E57SBL12T111SD</b>	136151				
	4	Non-flush	NPN	2 m connection cable	1 N/O	<b>E57SAL12T110E</b>	136099				
			NPN	Plug-in connection M12 x 1	1 N/O	<b>E57SAL12T110ED</b>	136100				
			PNP	2 m connection cable	1 N/O	<b>E57SAL12T111E</b>	136103				
			PNP	Plug-in connection M12 x 1	1 N/O	<b>E57SAL12T111ED</b>	136104				
			NPN	2 m connection cable	1 NC	<b>E57SBL12T110E</b>	136146				
			NPN	Plug-in connection M12 x 1	1 NC	<b>E57SBL12T110ED</b>	136147				
			PNP	2 m connection cable	1 NC	<b>E57SBL12T111E</b>	136149				
			PNP	Plug-in connection M12 x 1	1 NC	<b>E57SBL12T111ED</b>	136150				
			M18 x 1								
				5	Flush	NPN	2 m connection cable	1 N/O	<b>E57SAL18T110</b>	136114	
						NPN	Plug-in connection M12 x 1	1 N/O	<b>E57SAL18T110SD</b>	136117	
						PNP	2 m connection cable	1 N/O	<b>E57SAL18T111</b>	136118	
PNP	Plug-in connection M12 x 1	1 N/O				<b>E57SAL18T111SD</b>	136121				
NPN	2 m connection cable	1 NC				<b>E57SBL18T110</b>	136160				
NPN	Plug-in connection M12 x 1	1 NC				<b>E57SBL18T110SD</b>	136163				
5	Non-flush	PNP		2 m connection cable	1 NC	<b>E57SBL18T111</b>	136164				
		PNP		Plug-in connection M12 x 1	1 NC	<b>E57SBL18T111SD</b>	136167				
		NPN		2 m connection cable	1 N/O	<b>E57SAL18T110E</b>	136115				
		NPN		2 m connection cable	1 NC	<b>E57SBL18T110E</b>	136161				
		NPN		Plug-in connection M12 x 1	1 N/O	<b>E57SAL18T110ED</b>	136116				
		PNP		2 m connection cable	1 N/O	<b>E57SAL18T111E</b>	136119				
			PNP	Plug-in connection M12 x 1	1 N/O	<b>E57SAL18T111ED</b>	136120				
			NPN	Plug-in connection M12 x 1	1 NC	<b>E57SBL18T110ED</b>	136162				
			PNP	2 m connection cable	1 NC	<b>E57SBL18T111E</b>	136165				
			PNP	Plug-in connection M12 x 1	1 NC	<b>E57SBL18T111ED</b>	136166				
			M30 x 1.5								
				15	Flush	NPN	2 m connection cable	1 N/O	<b>E57SAL30T110</b>	136130	
NPN	Plug-in connection M12 x 1	1 N/O				<b>E57SAL30T110SD</b>	136133				
PNP	2 m connection cable	1 N/O				<b>E57SAL30T111</b>	136134				
PNP	Plug-in connection M12 x 1	1 N/O				<b>E57SAL30T111SD</b>	136137				
NPN	2 m connection cable	1 NC				<b>E57SBL30T110</b>	136176				
NPN	Plug-in connection M12 x 1	1 NC				<b>E57SBL30T110SD</b>	136179				
PNP	2 m connection cable	1 NC				<b>E57SBL30T111</b>	136180				
PNP	Plug-in connection M12 x 1	1 NC				<b>E57SBL30T111SD</b>	136183				
15	Non-flush	NPN				2 m connection cable	1 N/O	<b>E57SAL30T110E</b>	136131		
		NPN		2 m connection cable	1 NC	<b>E57SBL30T110E</b>	136177				
		NPN		Plug-in connection M12 x 1	1 N/O	<b>E57SAL30T110ED</b>	136132				
		PNP		2 m connection cable	1 N/O	<b>E57SAL30T111E</b>	136135				
		PNP		Plug-in connection M12 x 1	1 N/O	<b>E57SAL30T111ED</b>	136136				
		NPN		Plug-in connection M12 x 1	1 NC	<b>E57SBL30T110ED</b>	136178				
		PNP		2 m connection cable	1 NC	<b>E57SBL30T111E</b>	136181				
		PNP		Plug-in connection M12 x 1	1 NC	<b>E57SBL30T111ED</b>	136182				

Information relevant for export to North America



Product Standards	UL 508; CSA-C22.2 No. 14; IEC60947-5-2; CE marking
UL File No.	E166051
UL CCN	NRKH, NRKH7
CSA File No.	50513
CSA Class No.	3211-03
NA Certification	UL listed, CSA certified
Max. Voltage Rating	250 V AC, 250 V DC
Degree of Protection	IEC: IP67; UL/CSA Type: 4, 4x, 6, 6P, 12, 13

Engineering

Circuit diagram

Rated operational voltage

2-Wire Sensors

AC/DC and AC sensors  
Example AC connection

Contact

N/O and NC

2 m connection cable

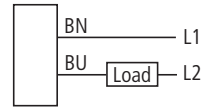

Plug-in connection M12 (front view plug)

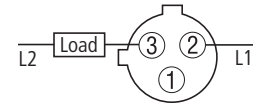

AC/DC sensor  
Example DC current connection

N/O and NC (NPN)

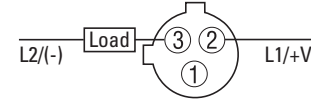
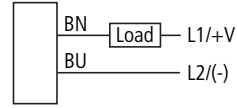

N/O and NC (PNP)

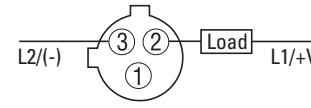
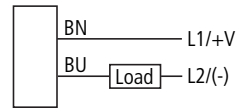

3-Wire Sensors  
6-48 V DC\_x

N/O (NPN)

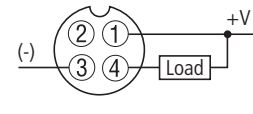
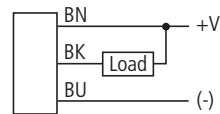

N/O (PNP)

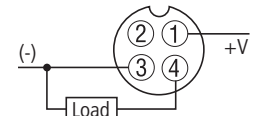
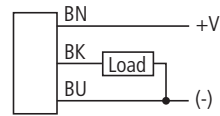

NC (NPN)

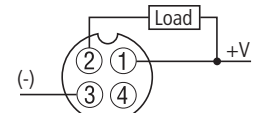
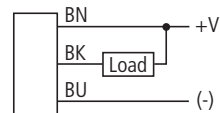

NC (PNP)

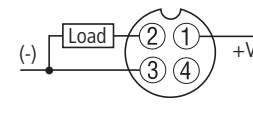
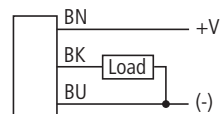

## Technical data

		E57L...L12A... E57L...L18A... E57R...L18A... E57L...L30A...	E57L...L12T... E57L...L18T... E57R...L18T... E57L...L30T...	E57-12LE... E57-18LE... E57-30LE...
<b>General</b>				
Standards		IEC/EN 60947-5-2	IEC/EN 60947-5-2	IEC/EN 60947-5-2
Ambient temperature	°C	- 25 - + 70	- 25 - + 70	- 25 - + 70
Protection type		IP67	IP67	IP67
Mechanical shock resistance	g	30 Shock duration 11 ms	30 Shock duration 11 ms	30 Shock duration 11 ms
<b>Characteristics</b>				
Temperature drift of $S_n$	%	10	10	10
Switching hysteresis of $S_n$	%	20	15	15
Rated operational voltage	$U_e$	20 - 250 V AC	6 - 48 V DC	6 - 48 V DC
Maximum load current	$I_e$	< 500 (25 °C) / 250 (70 °C)	< 500 (6 - 30 V DC)	< 500 (6 - 30 V DC)
Switching Frequency				
	... L12A...	Hz	20	800
	... L18A...	Hz	20	500
	... L30A...	Hz	20	300
Switching state display	LED	Red	Red	Red
Connection		2-wire	3-wire	3-wire
Design (outer dimensions)				
	... L12A...	mm	M12 x 1	M12 x 1
	... L18A...	mm	M18 x 1	M18 x 1
	... L30A...	mm	M30 x 1.5	M30 x 1
Material		Stainless steel	Stainless steel	Stainless steel

		E57S...L12A2 E57S...L18A2 E57S...L30A2	E57S...L12A4 E57S...L18A4 E57S...L30A4	E57S...L12T... E57S...L18T... E57S...L30T...
<b>General</b>				
Standards		IEC/EN 60947-5-2	IEC/EN 60947-5-2	IEC/EN 60947-5-2
Ambient temperature	°C	- 25 - + 70	- 25 - + 70	- 25 - + 70
Protection type		IP67	IP67	IP67
Mechanical shock resistance	g	30 Shock duration 11 ms	30 Shock duration 11 ms	30 Shock duration 11 ms
<b>Characteristics</b>				
Temperature drift of $S_n$	%	10	10	10
Switching hysteresis of $S_n$	%	20	20	15
Rated operational voltage	$U_e$	40 - 250 V AC 20 - 250 V DC	40 - 250 V AC	6 - 48 V DC
Maximum load current	$I_e$	< 250 (25 °C) / 200 (70 °C)	< 500 (25 °C) / 250 (70 °C)	< 500 (6 - 32 V DC) / 250 (32 - 48 V DC)
Switching Frequency				
	... L12A...	Hz	60	800
	... L18A...	Hz	60	500
	... L30A...	Hz	60	300
Switching state display	LED	Red	Red	Red
Connection		2-wire	2-wire	3-wire
Design (outer dimensions)				
	... L12A...	mm	M12 x 1	M12 x 1
	... L18A...	mm	M18 x 1	M18 x 1
	... L30A...	mm	M30 x 1.5	M30 x 1.5
Material		Stainless steel	Stainless steel	Stainless steel

**Notes** Further technical data can be found in the Online Catalog at <http://de.ecat.moeller.net>



Dimensions

2 m connection cable

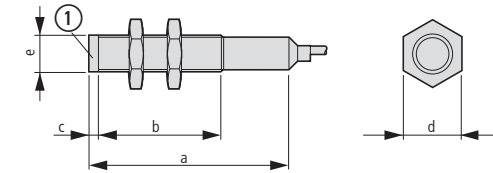

① Sensor surface

2	a	b	c	d	e
	mm (inch)	mm (inch)	mm (inch)	mm (inch)	mm

AC, 2 m connection cable

∅ 12	①	62.4 (2.46)	50.3 (1.98)	-	16.8 (0.67)	M12 x 1
	③	72.7 (2.87)	50.3 (1.98)	9.14 (0.36)	16.8 (0.67)	M12 x 1
∅ 18	①	64.5 (2.54)	50.9 (2.00)	-	23.8 (0.94)	M18 x 1
	③	66.0 (2.60)	37.2 (1.47)	14.1 (0.56)	23.8 (0.94)	M18 x 1
∅ 30	①	69.3 (2.73)	50.3 (1.98)	-	35.9 (1.41)	M30 x 1.5
	③	69.3 (2.73)	37.8 (1.49)	13.26 (0.52)	35.9 (1.41)	M30 x 1.5

AC, plug-in connection M12

∅ 12	①	68.4 (2.69)	50.3 (1.98)	-	16.8 (0.67)	M12 x 1
	③	77.7 (3.06)	50.3 (1.98)	9.14 (0.36)	9.14 (0.36)	M12 x 1
∅ 18	①	69.06 (2.72)	50.9 (2.00)	-	23.8 (0.94)	M18 x 1
	③	69.4 (2.74)	37.2 (1.47)	14.1 (0.56)	23.8 (0.94)	M18 x 1
∅ 30	①	73.8 (2.91)	50.3 (1.98)	-	35.9 (1.41)	M30 x 1.5
	③	73.8 (2.91)	37.8 (1.49)	13.26 (0.52)	35.9 (1.41)	M30 x 1.5

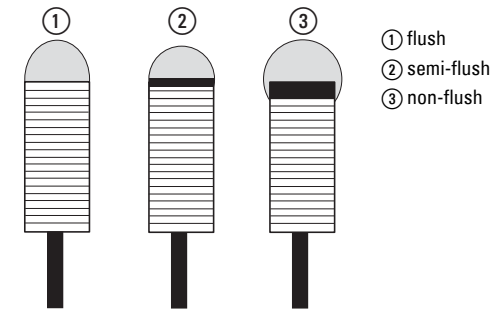

Plug-in connection M12 x 1

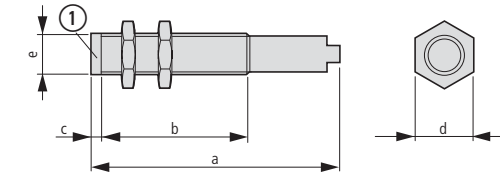

3	a_x	b_x	c_x	d_x	e_x
	mm (inch)_x	mm (inch)_x	mm (inch)_x	mm (inch)_x	MM_x

DC, 2 m connection cable

∅ 12	①	62.4 (2.46)	50.3 (1.98)	-	16.8 (0.67)	_xM12 x 1
	②	72.8 (2.87)	57.9 (2.28)	1.62 (0.06)	16.8 (0.67)	_xM12 x 1
	③	72.7 (2.87)	50.3 (1.98)	9.14 (0.36)	16.8 (0.67)	_xM12 x 1
∅ 18	①	64.5 (2.54)	50.9 (2.00)	-	23.8 (0.94)	_xM18 x 1
	②	66.1 (2.60)	48.2 (1.90)	2.54 (0.10)	23.8 (0.94)	_xM18 x 1
	③	66.0 (2.60)	37.2 (1.47)	14.1 (0.56)	23.8 (0.94)	_xM18 x 1
∅ 30	①	69.3 (2.73)	50.3 (1.98)	-	35.9 (1.41)	M30 x 1.5
	②	67.8 (2.67)	48.2 (1.90)	3.30 (0.13)	35.9 (1.41)	M30 x 1.5
	③	69.3 (2.73)	37.8 (1.49)	13.26 (0.52)	35.9 (1.41)	M30 x 1.5

DC, plug-in connection M12

∅ 12	①	68.7 (2.71)	50.3 (1.98)	-	16.8 (0.67)	_xM12 x 1
	②	77.2 (3.04)	57.9 (2.28)	1.62 (0.06)	16.8 (0.67)	_xM12 x 1
	③	77.7 (3.06)	50.9 (1.98)	9.14 (0.36)	16.8 (0.67)	_xM12 x 1
∅ 18	①	69.3 (2.73)	50.9 (2.00)	-	23.8 (0.94)	_xM18 x 1
	②	69.1 (2.72)	48.2 (1.90)	2.54 (0.10)	23.8 (0.94)	_xM18 x 1
	③	69.4 (2.74)	37.2 (1.47)	14.1 (0.56)	23.8 (0.94)	_xM18 x 1
∅ 30	①	74.1 (2.92)	50.3 (1.98)	-	35.9 (1.41)	M30 x 1.5
	②	70.6 (2.78)	48.2 (1.90)	3.30 (0.13)	35.9 (1.41)	M30 x 1.5
	③	74.1 (2.92)	37.8 (1.49)	13.26 (0.52)	35.9 (1.41)	M30 x 1.5

E57R...A2...  
E57R...110...  
E57R...111...

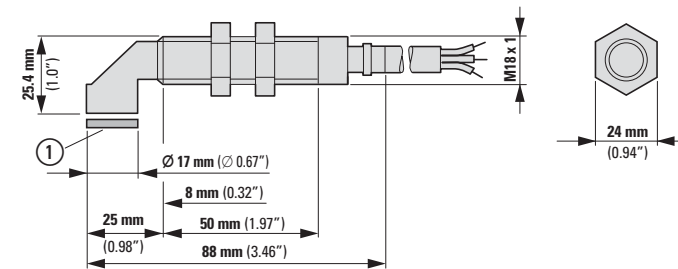

① Sensor surface

E57R...SA  
E57R...EA  
E57R...SD  
E57R...ED

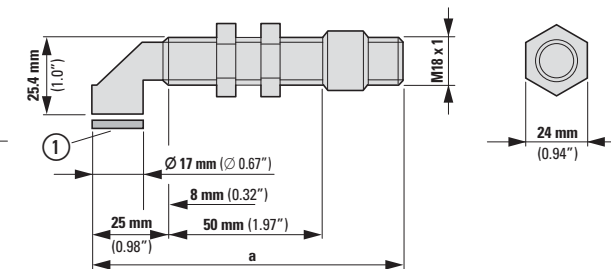

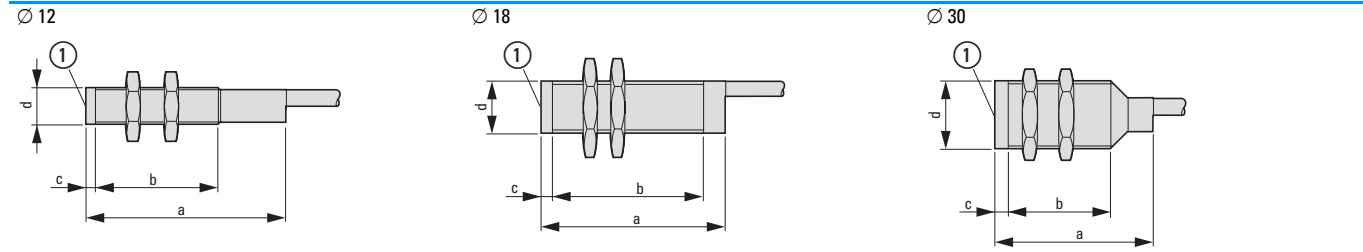

① Sensor surface

	a_x mm (inch)_x	b_x mm (inch)_x	c_x mm (inch)_x	d_x MM_x
---	--------------------	--------------------	--------------------	-------------

AC, 2 m connection cable					
Ø 12	①	51.7 (2.04)	39.6 (1.56)	0.5 (0.02)	_xM12 x 1
	③	51.7 (2.04)	35.1 (1.38)	5 (0.20)	_xM12 x 1
Ø 18	①	35.3 (1.39)	0.86 (21.82)	0.5 (0.02)	_xM18 x 1
	③	35.3 (1.39)	15.32 (0.60)	7 (0.28)	_xM18 x 1
Ø 30	①	40.2 (1.58)	25.15 (0.99)	0.8 (0.03)	M30 x 1.5
	③	44.9 (1.77)	17.27 (0.68)	13.26 (0.52)	M30 x 1.5

	a_x mm (inch)_x	b_x mm (inch)_x	c_x mm (inch)_x	d_x MM_x
---	--------------------	--------------------	--------------------	-------------

DC, 2 m connection cable					
Ø 12	①	35.3 (1.39)	23.09 (0.91)	0.5 (0.02)	_xM12 x 1
	③	35.3 (1.39)	18.59 (0.73)	5 (0.20)	_xM12 x 1
Ø 18	①	35.3 (1.39)	21.82 (0.86)	0.5 (0.02)	_xM18 x 1
	③	35.3 (1.39)	15.32 (0.60)	7 (0.28)	_xM18 x 1
Ø 30	①	40.2 (1.58)	21.26 (0.84)	0.8 (0.03)	M30 x 1.5
	③	44.9 (1.77)	13.46 (0.53)	13.26 (0.52)	M30 x 1.5

AC/DC, 2 m connection cable					
Ø 12	①	62.4 (2.46)	50.27 (1.98)	-	_xM12 x 1
	③	62.4 (2.46)	45.77 (1.80)	5 (0.20)	_xM12 x 1
Ø 18	①	64.5 (2.54)	50.9 (2.00)	-	_xM18 x 1
	③	64.5 (2.54)	44.4 (1.75)	7 (0.28)	_xM18 x 1
Ø 30	①	69.3 (2.72)	53.8 (2.12)	-	M30 x 1.5
	③	69.3 (2.72)	41.4 (1.63)	13.26 (0.52)	M30 x 1.5

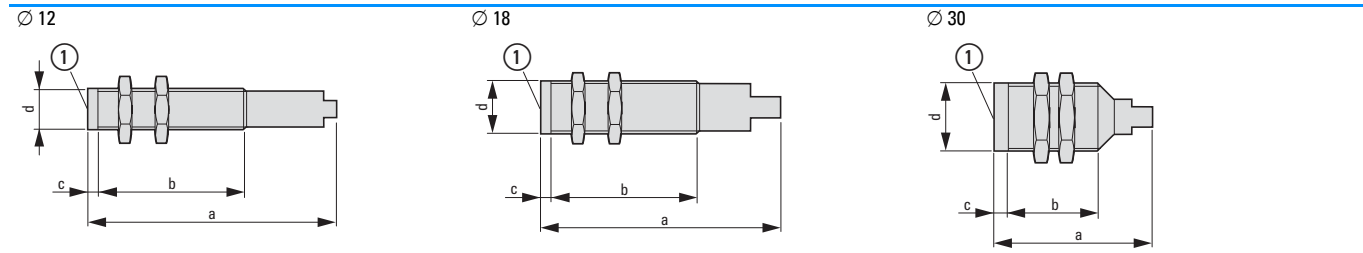
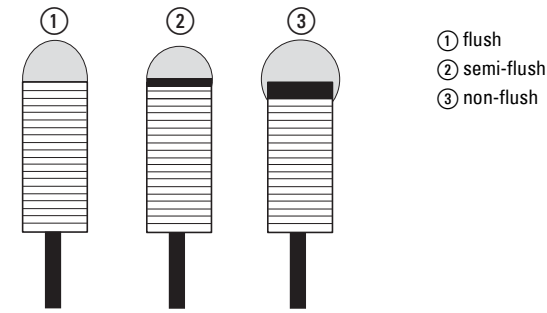

① Sensor surface

	a_x mm (inch)_x	b_x mm (inch)_x	c_x mm (inch)_x	d_x MM_x
---	--------------------	--------------------	--------------------	-------------

AC, plug-in connection M12					
Ø 12	①	57.8 (2.27)	39.6 (1.56)	0.5 (0.02)	_xM12 x 1
	③	57.8 (2.27)	35.1 (1.38)	5 (0.20)	_xM12 x 1
Ø 18	①	40.0 (1.57)	21.82 (0.86)	0.5 (0.02)	_xM18 x 1
	③	40.0 (1.57)	15.32 (0.60)	7 (0.28)	_xM18 x 1
Ø 30	①	44.8 (1.76)	25.15 (0.99)	0.8 (0.03)	M30 x 1.5
	③	49.5 (1.95)	17.27 (0.68)	13.26 (0.52)	M30 x 1.5

	a_x mm (inch)_x	b_x mm (inch)_x	c_x mm (inch)_x	d_x MM_x
---	--------------------	--------------------	--------------------	-------------

DC, plug-in connection M12					
Ø 12	①	41.5 (1.64)	23.09 (0.91)	0.5 (0.02)	_xM12 x 1
	③	41.5 (1.64)	18.59 (0.73)	5 (0.20)	_xM12 x 1
Ø 18	①	40.3 (1.59)	21.82 (0.86)	0.5 (0.02)	_xM18 x 1
	③	40.3 (1.59)	15.32 (0.60)	7 (0.28)	_xM18 x 1
Ø 30	①	45.0 (1.77)	21.26 (0.84)	0.8 (0.03)	M30 x 1.5
	③	49.7 (1.96)	13.46 (0.53)	13.26 (0.52)	M30 x 1.5

AC/DC, plug-in connection M12					
Ø 12	①	68.4 (2.69)	50.27 (1.98)	-	_xM12 x 1
	③	68.4 (2.69)	45.77 (1.80)	5 (0.20)	_xM12 x 1
Ø 18	①	69.06 (2.72)	50.9 (2.00)	-	_xM18 x 1
	③	69.06 (2.72)	44.4 (1.75)	7 (0.28)	_xM18 x 1
Ø 30	①	73.8 (2.91)	53.8 (2.12)	-	M30 x 1.5
	③	73.8 (2.91)	41.4 (1.63)	13.26 (0.52)	M30 x 1.5

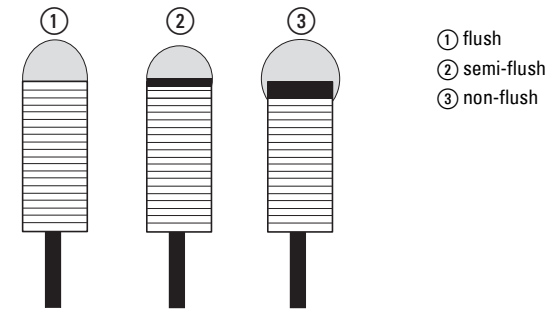

**Description**



- ① High Quality Stainless Steel Housings.
- ② M12 plug connector available for sizes 6.5 and 8 mm.
- ③ Sizes 5 mm and 8 mm with thread; 4 mm and 6.5 mm without thread.
- ④ Size 6.5 mm supplied complete with mounting bracket.

**Short description**

Eaton's unique inductive proximity have been developed specially for use in extremely small spaces. The wide range of available models with housing diameters from 8 mm down to 4 mm covers a multitude of application scenarios. The sensors feature three-wire connections with an input voltage of 10 to 30 V DC. Both shielded and unshielded versions are available.





**Product features**

- Small 4, 5, 6.5 and 8 mm diameters for use in applications with limited space for mounting sensors.
- Stainless steel enclosure.
- All models have an output status display.
- Short-circuit and reverse polarity protection.
- High degree of protection IP67.

**Approvals**



## Ordering

mm	Rated switching distance $S_n$ mm	Type of mounting	Switching type	For connection of:	Contact configuration N/O = normally open contact N/C = normally closed contact	Part no.	Article no.	Price see price list	Std. pack
<b>E57-Miniatur</b>									
Stainless steel, 3-wire, Rated operational voltage $U_e$ 10 - 30 V DC									
Ø 4									
	0.8	Flush	NPN	2 m connection cable	1 N/O	<b>E57EAL4T110SP</b>	136238		1 off
			PNP			<b>E57EAL4T111SP</b>	136239		
M5 x 1									
	0.8	Flush	NPN	2 m connection cable	1 N/O	<b>E57EAL5T110SP</b>	136240		1 off
			PNP			<b>E57EAL5T111SP</b>	136241		
Ø 6,5									
	1	Flush	NPN	2 m connection cable	1 N/O	<b>E57EAL6T110SP</b>	136243		1 off
			PNP			<b>E57EAL6T111SP</b>	136245		
	2	Non-flush	NPN	2 m connection cable	1 N/O	<b>E57EAL6T110EP</b>	136242		
			PNP			<b>E57EAL6T111EP</b>	136244		
M8 x 1									
	1	Flush	NPN	2 m connection cable	1 N/O	<b>E57EAL8T110SP</b>	136249		1 off
				1 NC	<b>E57EBL8T110SP</b>	136257			
				Plug-in connection M12 x 1	1 N/O	<b>E57EAL8T110SD</b>	136248		
			1 NC	<b>E57EBL8T110SD</b>	136256				
			PNP	2 m connection cable	1 N/O	<b>E57EAL8T111SP</b>	136253		
				1 NC	<b>E57EBL8T111SP</b>	136261			
	Plug-in connection M12 x 1	1 N/O		<b>E57EAL8T111SD</b>	136252				
	2	Non-flush	NPN	2 m connection cable	1 N/O	<b>E57EAL8T110EP</b>	136247		
				1 NC	<b>E57EBL8T110EP</b>	136255			
				Plug-in connection M12 x 1	1 N/O	<b>E57EAL8T110ED</b>	136246		
			1 NC	<b>E57EBL8T110ED</b>	136254				
			PNP	2 m connection cable	1 N/O	<b>E57EAL8T111EP</b>	136251		
1 NC				<b>E57EBL8T111EP</b>	136259				
Plug-in connection M12 x 1	1 N/O	<b>E57EAL8T111ED</b>		136250					
			1 NC	<b>E57EBL8T111ED</b>	136258				

Technical data		Miniature series E-57	
<b>General</b>			
Standards			IEC/EN 60947-5
Ambient temperature		°C	- 25 - + 70
Protection type			IP67
Mechanical shock resistance		g	30 Shock duration 11 ms
<b>Characteristics</b>			
Repetition accuracy of $S_n$		%	1
Temperature drift of $S_n$		%	10
Switching hysteresis of $S_n$		%	15
Rated operational voltage		$U_e$	10 - 30 V DC
Operating current in the switched state at 24 V DC	$I_b$	mA	10
Maximum load current	$I_e$	mA	200
Voltage drop at $I_e$	$U_d$	V	1.5
Switching Frequency		Hz	2000
Residual current through the load in the blocked state at 230 V AC and 24 V DC	$I_r$	mA	0.01
Switching state display		LED	Red
Protective functions			Short-circuit protective device
Connection			3-wire
Material			Stainless steel

**Notes** Further technical data can be found in the Online Catalog at <http://de.ecat.moeller.net>

Engineering

Circuit diagram

Rated operational voltage  
3-Wire Sensors  
10 – 30 V DC

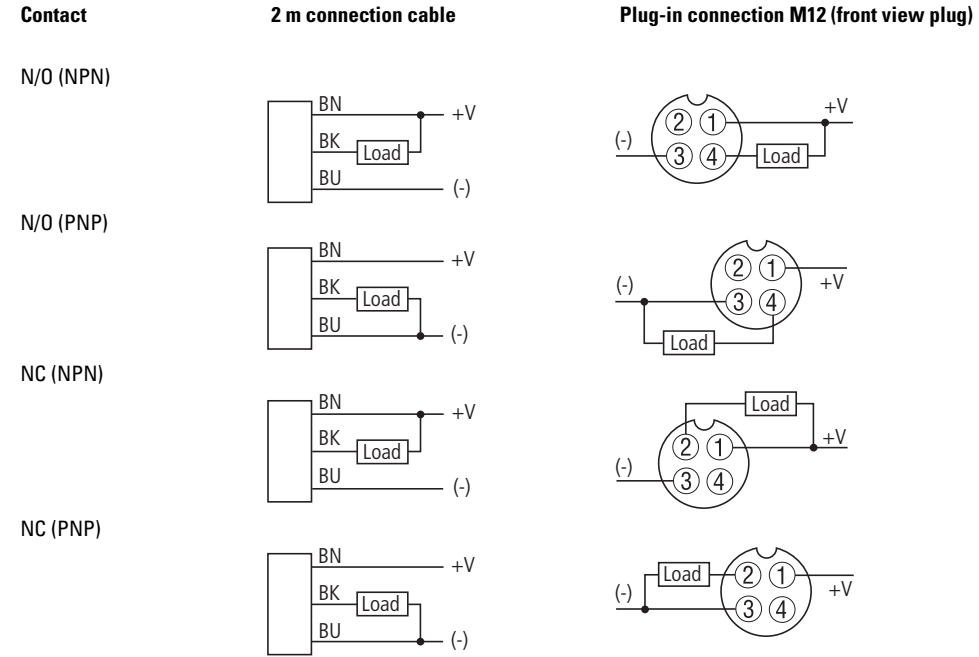

Dimensions

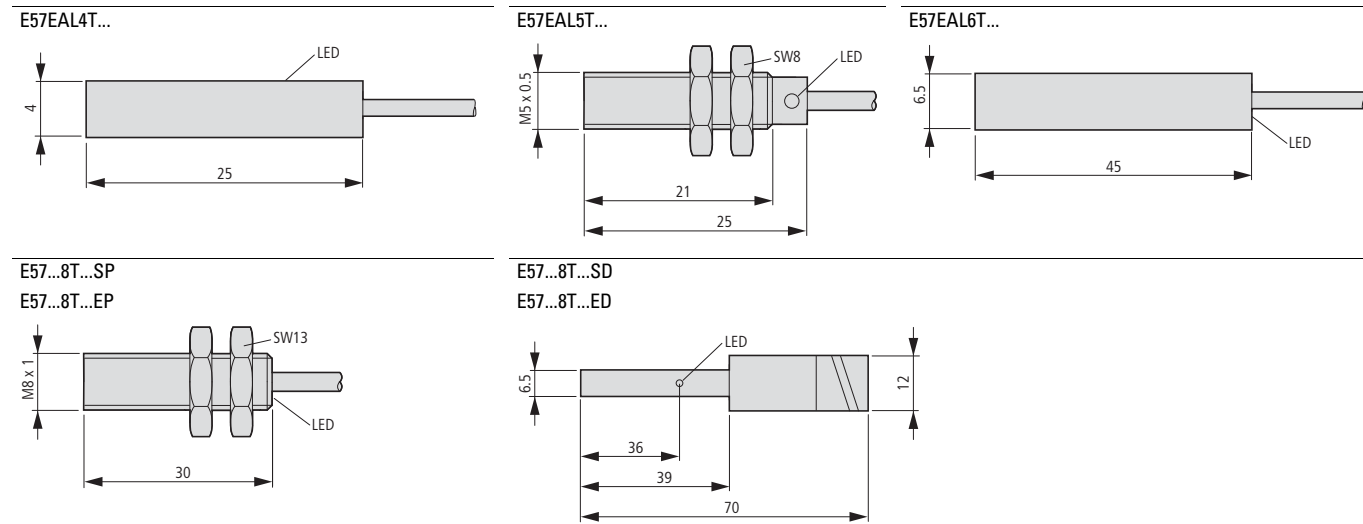



## Description

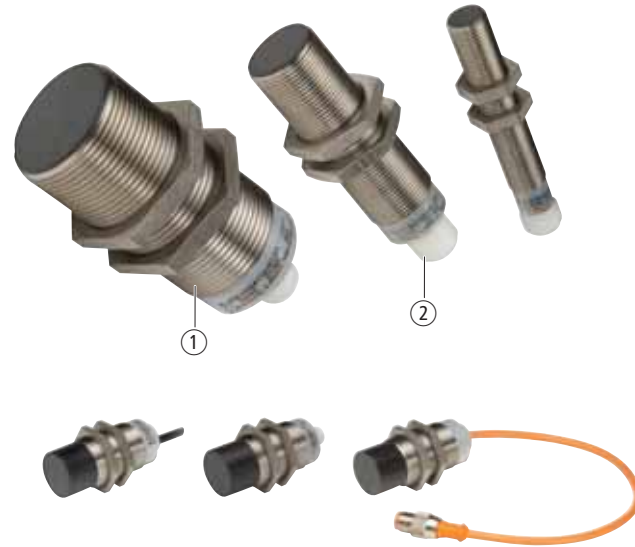

- ① Two-color 360° output signal lamp  
② Shock Absorbing Ryton Face Cap Material®

## Short Description

The iProx is Eaton's highest-performance and most versatile inductive, cylindrical sensor. With its built-in microprocessor and unique Smart-Sense™ technology this sensor has three times the range of other sensors in its class and offers unique configurability. Both screened and unscreened versions of the sensor have an extended range so that the sensor can be positioned further away from the target object. This reduces the risk of a collision with the target object and increases operational reliability. The iProx also has many extended functions, which can be activated through the optionally available programming tools. With Windows software ProxView the sensor can be programmed for any application. Sensor characteristics such as range can be set to the nearest tenth of a millimeter. The outputs can be configured as N/O or NC. Even interference immunity and response time can be adjusted. In addition the iProx features a built-in logic for deceleration and speed detection – without complex PLC programming. With its large range, high quality, sophisticated design, and adaptability to its environment, iProx is the ideal choice for demanding applications.









## Product Features

- Available as DC 3-wire version.
- Reliably detect metal targets at up to three times the range of conventional screened or unscreened tubular inductive sensors
- Quality construction using a stainless steel barrel, 360°-degree dual-color LED indicator, Ryton impact-resistant cap® and vibration-absorbing potting compound.
- The automatic configuration automatically detects NPN and PNP connections and switches the sensor accordingly and without user interaction.
- Configurable range, band detection, background (metal) object detection, deceleration and speed detection thanks to the microprocessor-based Smart-Sense™ technology.
- Optional computer programming cable and Windows-based ProxView configuration software makes it easy to customize sensors.
- Resistant to high interference levels (up to 20 V/m).
- Resistant to extreme temperatures (-40 °C).

## Approvals



Ordering

	Rated operational voltage $U_e$	Rated switching distance $S_n$ mm	Type of mounting	Switch-ing type	For connection of:	Contact configuration N/O = normally open contact N/C = normally closed contact	Material	Part no. Article no.	Price see price list	Std. pack
<b>iProx</b>										
<b>3-wire</b>										
<b>M12 x 1</b>										
	6 - 48 V DC	4	Flush	NPN PNP	2 m connection cable	1 N/O	Stainless steel	<b>E59-M12A105C02-D1</b> 136205		1 off  
						1 NC		<b>E59-M12A105C02-D2</b> 136206		
			Plug-in connection M12 x 1	1 N/O	<b>E59-M12A105D01-D1</b> 136207					
				1 NC	<b>E59-M12A105D01-D2</b> 136208					
		10	Non-flush	NPN PNP	2 m connection cable	1 N/O	<b>E59-M12C110C02-D1</b> 136209			
						1 NC	<b>E59-M12C110C02-D2</b> 136210			
Plug-in connection M12 x 1	1 N/O	<b>E59-M12C110D01-D1</b> 136211								
	1 NC	<b>E59-M12C110D01-D2</b> 136212								
<b>M18 x 1</b>										
	6 - 48 V DC	8	Flush	NPN PNP	2 m connection cable	1 N/O	Stainless steel	<b>E59-M18A108C02-D1</b> 136213		1 off  
						1 NC		<b>E59-M18A108C02-D2</b> 136214		
			Plug-in connection M12 x 1	1 N/O	<b>E59-M18A108D01-D1</b> 136215					
				1 NC	<b>E59-M18A108D01-D2</b> 136216					
		18	Non-flush	NPN PNP	2 m connection cable	1 N/O	<b>E59-M18C116C02-D1</b> 136217			
						1 NC	<b>E59-M18C116C02-D2</b> 136218			
Plug-in connection M12 x 1	1 N/O	<b>E59-M18C116D01-D1</b> 136219								
	1 NC	<b>E59-M18C116D01-D2</b> 136220								
<b>M30 x 1.5</b>										
	6 - 48 V DC	15	Flush	NPN PNP	2 m connection cable	1 N/O	Stainless steel	<b>E59-M30A115C02-D1</b> 136221		1 off  
						1 NC		<b>E59-M30A115C02-D2</b> 136222		
			Plug-in connection M12 x 1	1 N/O	<b>E59-M30A115D01-D1</b> 136223					
				1 NC	<b>E59-M30A115D01-D2</b> 136224					
		29	Non-flush	NPN PNP	2 m connection cable	1 N/O	<b>E59-M30C129C02-D1</b> 136225			
						1 NC	<b>E59-M30C129C02-D2</b> 136226			
Plug-in connection M12 x 1	1 N/O	<b>E59-M30C129D01-D1</b> 136227								
	1 NC	<b>E59-M30C129D01-D2</b> 136228								
Programming cable	-	-	-	-	Plug-in connection M12 x 1	-	<b>E59RP1</b> 136229		1 off	
Programming software	-	-	-	-	Plug-in connection M12 x 1	-	<b>E59SW1</b> 136230		1 off	

Information relevant for export to North America



Product Standards  
UL File No.  
UL CCN  
CSA File No.

UL 508; CSA-C22.2 No. 14; IEC60947-5-2; CE marking  
E166051  
NRKH, NRKH7  
UL report applies to both Canada and US

CSA Class No.  
NA Certification  
Max. Voltage Rating  
Degree of Protection

-  
UL listed, certified by UL for use in Canada  
48 V DC  
IEC: IP67, IP69K; UL/CSA Type: 4, 4x, 6, 6P, 12, 13

Technical data

	E59-M12A105	E59-M18A108	E59-M12C110	E59-M30A115	E59-M18C116	E59-M30C129		
<b>General</b>								
Standards	IEC/EN 60947-5-2							
Ambient temperature	°C - 40 - + 70							
Protection type	IP67	IP69K	IP67	IP69K	IP69K	IP69K		
Mechanical shock resistance	g 30 Shock duration 11 ms							
<b>Characteristics</b>								
Rated switching distance								
Rated switching distance	S <sub>n</sub>	mm	4	8	10	15	18	29
Repetition accuracy of S <sub>n</sub>		%	1	1	3	1	3	3
Temperature drift of S <sub>n</sub>		%	10	10	10	10	10	10
Switching hysteresis of S <sub>n</sub>		%	15	15	15	15	15	15
Range		mm	-	-	-	-	-	-
Rated operational voltage	U <sub>e</sub>	V DC	6 - 48 V DC	6 - 48 V DC	6 - 48 V DC	6 - 48 V DC	6 - 48 V DC	6 - 48 V DC
Supply frequency								
Residual ripple of U <sub>e</sub>		%	-	-	-	-	-	-
Operating current in the switched state at 24 V DC	I <sub>b</sub>	mA	15	15	15	15	15	15
Maximum load current	I <sub>e</sub>	mA	300	300	300	300	300	300
Voltage drop at I <sub>e</sub>	U <sub>d</sub>	V	2.5	2.5	2.5	2.5	2.5	2.5
Switching Frequency		Hz	580	390	300	240	150	145
Min. load current	I <sub>e</sub>	mA	1	1	1	1	1	1
Short-time current (10 ms, 5 Hz)		A	-	-	-	-	-	-
Residual current through the load in the blocked state at 230 V AC and 24 V DC	I <sub>r</sub>	mA	0.15	0.15	0.15	0.15	0.15	0.15
Switching state display	LED		Red	Red	Red	Red	Red	Red
Operating voltage display	LED		Green	Green	Green	Green	Green	Green
Boundary gain			-	-	-	-	-	-
Protective functions	Short-circuit protective device							
Connection			3-wire	3-wire	3-wire	3-wire	3-wire	3-wire
Design (outer dimensions)		mm	M12 x 1	M18 x 1	M12 x 1	M30 x 1.5	M18 x 1	M30 x 1.5
Material			Stainless steel	Stainless steel	Stainless steel	Stainless steel	Stainless steel	Stainless steel

**Notes** Further technical data can be found in the Online Catalog at <http://de.ecat.moeller.net>

Engineering

Circuit diagram

E59...C02-D1  
E59...C02-D2

E59...D01-D1  
E59...D01-D2

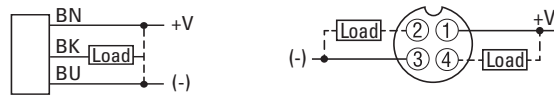

Pins 2 and 4 internally interconnected.

Dimensions

2 m connection cable

E59-M...C02...

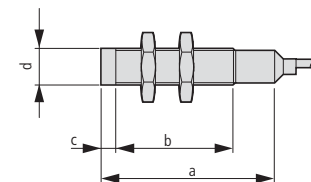

Type	a_x	b_x	c_x	d_x
	mm (inch)_x	mm (inch)_x	mm (inch)_x	mm (inch)_x
E59-M12A...	62.4 (2.46)	50.3 (1.98)	0.5 (0.02)	_xM12 x 1
E59-M12C...	62.4 (2.46)	41.6 (1.64)	9 (0.35)	_xM12 x 1
E59-M18A...	64.5 (2.54)	50.9 (2.0)	0.5 (0.02)	_xM18 x 1
E59-M18C...	64.5 (2.54)	37.4 (1.47)	14 (0.55)	_xM18 x 1
E59-M30A...	69.6 (2.74)	54.1 (2.13)	0.75 (0.03)	M30 x 1.5
E59-M30CA...	69.6 (2.74)	35.8 (1.41)	19 (0.75)	M30 x 1.5

Plug-in connection M12 x 1

E59-M...D01...

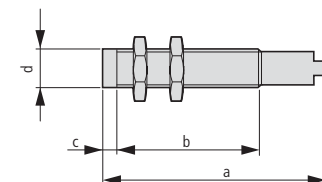

Type	a_x	b_x	c_x	d_x
	mm (inch)_x	mm (inch)_x	mm (inch)_x	mm (inch)_x
E59-M12A...	68.7 (2.7)	50.3 (1.98)	0.5 (0.02)	_xM12 x 1
E59-M12C...	68.7 (2.7)	41.6 (1.64)	9 (0.35)	_xM12 x 1
E59-M18A...	69.3 (2.73)	50.9 (2.0)	0.5 (0.02)	_xM18 x 1
E59-M18C...	69.3 (2.73)	37.4 (1.47)	14 (0.55)	_xM18 x 1
E59-M30A...	74.1 (2.92)	54.1 (2.13)	0.75 (0.03)	M30 x 1.5
E59-M30CA...	74.1 (2.92)	35.8 (1.41)	19 (0.75)	M30 x 1.5

**Description****Short Description**

The AccuProx is a high performance analog inductive proximity sensor. The AccuProx family of analog sensors provide unmatched sensing range, linearity and resolution in an affordable and compact tubular enclosure.

Unlike standard inductive sensors, which send an open or close signal upon target presence or absence, AccuProx analog sensors provide an electrical signal that varies in proportion to the position of the metal target within its sensing range.

This makes AccuProx ideal for applications requiring precise position sensing and measurement.

The sensing performance of AccuProx sets it apart from traditional analog inductive designs. Utilizing components from the cutting-edge iProx family, AccuProx provides sensing ranges of three to four times that of typical tubular analog inductive sensors — all without compromising accuracy.

AccuProx has the range and precision to solve your most difficult measurement applications.

**Typical Applications**

- Part positioning.
- Distance, size and thickness measurement.
- General inspection and error proofing, such as material imperfection or blemish detection.
- Eccentricity or Absolute Angle Detection.
- Identification of different metals.
- Two mounting options for maximum flexibility

**Product Features**

- Extended linear sensing range of up to 25 millimeters—three times longer than standard tubular analog inductive sensors.
- Current outputs (4-20 or 0-20 mA) and voltage outputs (0-10 V) available.
- High output resolution and repeatability for applications requiring precision sensing performance.
- Robust stainless steel barrel, shock-resistant front cap, polycarbonate end bell and impact-absorbing potting compound.
- Resistant to elevated temperatures and high-pressure sprays - ideal for environments with extreme temperatures and wet areas.
- High noise immunity of 20V/m prevents many problems associated with electrical noise.

**Approvals**

#### AccuProx - Powerful analog range in a tried-and-true enclosure

Historically, the range of applications for analog sensors has been severely limited due to short sensing ranges, which rarely exceed one or two millimeters. This, however, has changed with the use of a perfected technology that enables AccuProx sensors to sense objects at distances of up to 25 millimeters, all while maintaining excellent output accuracy levels.

AccuProx utilizes many of the proven materials found in other tubular sensor families. The threaded barrel and included mounting nuts are made of stainless steel, which exhibits superior corrosion and abrasion resistance versus nickel-plated brass. AccuProx also features a proprietary internal potting compound that absorbs impacts and vibration while sealing out moisture. The materials used in the construction of AccuProx are time-tested and proven to work.

#### High Output Accuracy

Analog inductive sensors are often used in applications that require a higher level of precision than a standard digital sensor. For example, applications such as part inspection require a sensor that can detect very small variances. AccuProx has been designed with these applications in mind.

Output accuracy is determined by the repetition accuracy, resolution, linearity and response time of the sensor.

The **Repetition accuracy** refers to the variations in sensing distance between successive sensor operations due to component tolerances, where all operating conditions are kept the same. The repetition accuracy of an 18 millimeter, unshielded AccuProx sensor is less than 20 micrometers.

**Resolution** refers to the number of "steps" in the sensor output. A higher resolution is ideal because it will allow the sensor to detect smaller changes in target position.

An 18 millimeter, unshielded AccuProx features more than 350 output steps, ensuring consistent performance.

The **Linearity** refers to the shape of the output curve. Many analog sensors exhibit a wavy or "S-shaped" output curve. This means that a change in target distance may not always translate into an equivalent change in output, particularly at the innermost and outermost ranges of a non-linear analog sensor. AccuProx features a linear output. See the diagram below for an example of AccuProx versus a non-linear sensor.

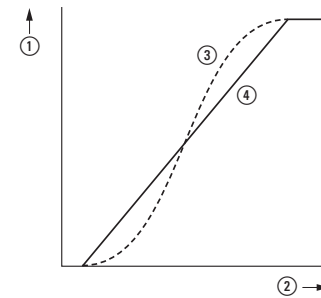

- ① Output
- ② Distance
- ③ Non-linear sensor
- ④ AccuProx Sensor

## Inductive Sensors

#### Typical Analog Applications

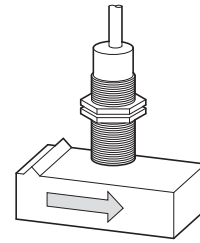

Material Imperfection or Blemish Detection

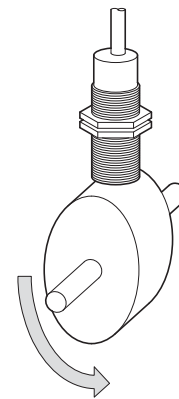



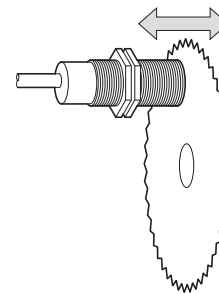





Eccentricity or Absolute Angle Detection



Saw Blade Deflection

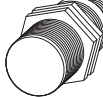

	Design (outer dimensions) mm	Rated switching distance S <sub>n</sub> mm	Type of mounting	For connection of:	Description	Part no. Article no.	Price see price list	Std. pack
<b>E59 AccuProx</b>								
3-wire/4-wire Rated operational voltage U <sub>o</sub> 15 - 30 V DC Analog Stainless steel								
	M12 x 1	0.5 - 4	Flush	Plug-in connection M12 x 1	Current output (0 - 20 mA) and voltage output (0 - 10 V)	<b>E59-A12A104D01-CV</b> 166834		1 off  
				2 m connection cable		<b>E59-A12A104C02-CV</b> 166832		
				Plug-in connection M12 x 1	Current output (4 - 20 mA)	<b>E59-A12A104D01-C1</b> 166833		
				2 m connection cable		<b>E59-A12A104C02-C1</b> 166831		
	1 - 8	Non-flush	Plug-in connection M12 x 1	Current output (0 - 20 mA) and voltage output (0 - 10 V)	<b>E59-A12C108D01-CV</b> 166838			
			2 m connection cable		<b>E59-A12C108C02-CV</b> 166836			
			Plug-in connection M12 x 1	Current output (4 - 20 mA)	<b>E59-A12C108D01-C1</b> 166837			
			2 m connection cable		<b>E59-A12C108C02-C1</b> 166835			
	M18 x 1	1 - 7	Flush	Plug-in connection M12 x 1	Current output (0 - 20 mA) and voltage output (0 - 10 V)	<b>E59-A18A107D01-CV</b> 166806		1 off  
				2 m connection cable		<b>E59-A18A107C02-CV</b> 166804		
				Plug-in connection M12 x 1	Current output (4 - 20 mA)	<b>E59-A18A107D01-C1</b> 166805		
				2 m connection cable		<b>E59-A18A107C02-C1</b> 166839		
	1 - 15	Non-flush	Plug-in connection M12 x 1	Current output (0 - 20 mA) and voltage output (0 - 10 V)	<b>E59-A18C115D01-CV</b> 166994			
			2 m connection cable		<b>E59-A18C115C02-CV</b> 166807			
			Plug-in connection M12 x 1	Current output (4 - 20 mA)	<b>E59-A18C115D01-C1</b> 166808			
			2 m connection cable		<b>E59-A18C115C02-C1</b> 138201			
	M30 x 1.5	1 - 12	Flush	Plug-in connection M12 x 1	Current output (0 - 20 mA) and voltage output (0 - 10 V)	<b>E59-A30A112D01-CV</b> 166685		1 off  
				2 m connection cable		<b>E59-A30A112C02-CV</b> 166719		
				Plug-in connection M12 x 1	Current output (4 - 20 mA)	<b>E59-A30A112D01-C1</b> 166684		
				2 m connection cable		<b>E59-A30A112C02-C1</b> 166809		
	1 - 25	Non-flush	Plug-in connection M12 x 1	Current output (0 - 20 mA) and voltage output (0 - 10 V)	<b>E59-A30C125D01-CV</b> 166689			
			2 m connection cable		<b>E59-A30C125C02-CV</b> 166687			
			Plug-in connection M12 x 1	Current output (4 - 20 mA)	<b>E59-A30C125D01-C1</b> 166688			
			2 m connection cable		<b>E59-A30C125C02-C1</b> 166686			

Engineering

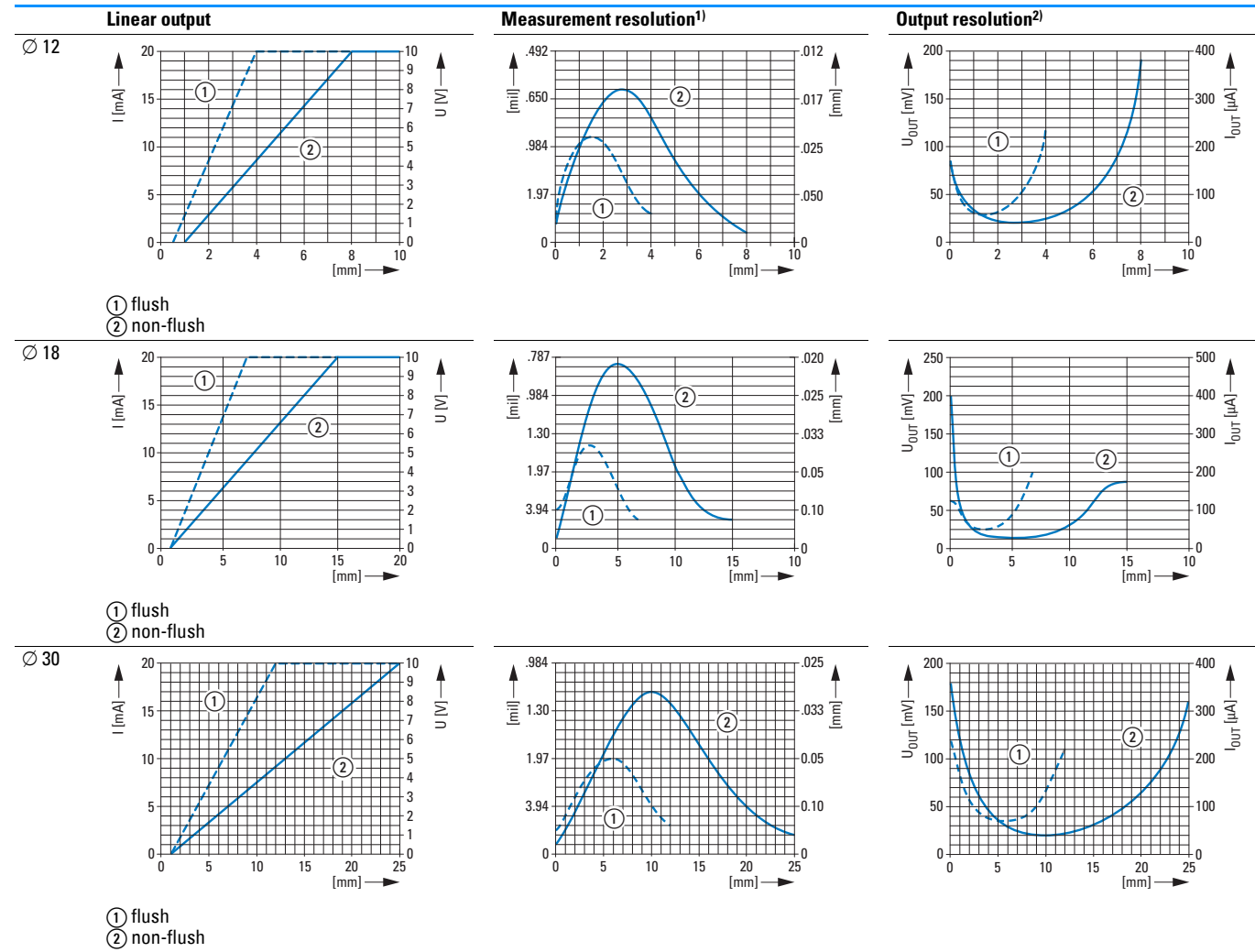

<sup>1)</sup>Measurement resolution is the sensor's ability to detect a change in target position. The measurement resolution is the finest at the highest point in the curve.  
<sup>2)</sup>Output resolution is the change in output signal relative to target position. The minimum change in output resolution is defined by the lowest point in the curve.

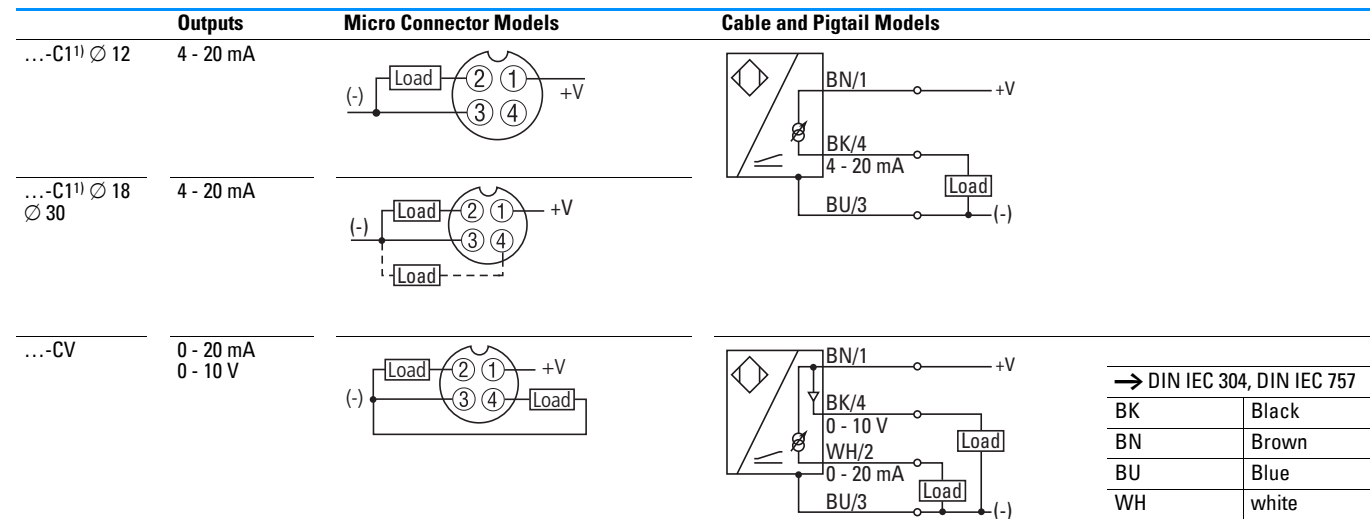

<sup>1)</sup> Pins 2 and 4 are internally connected in all models ending in -C1 (models with current output only).  
 → Do not connect the outputs of C1 models to different loads—these sensors should only be connected to one single output load!

Technical data

	E59-A12A...	E59-A12C...	E59-A18A...	E59-A18C...	E59-A30A...	E59-A30C...
<b>General</b>						
Standards	IEC/EN 60947-5-2	IEC/EN 60947-5-2	IEC/EN 60947-5-2	IEC/EN 60947-5-2	IEC/EN 60947-5-2	IEC/EN 60947-5-2
Ambient temperature	- 40 - + 70	- 40 - + 70	- 40 - + 70	- 40 - + 70	- 40 - + 70	- 40 - + 70
Protection type	IP67	IP67	IP67	IP67	IP67	IP67
Mechanical shock resistance	30 g Shock duration 11 ms					
<b>Characteristics</b>						
Rated switching distance	S <sub>n</sub> mm	0.5 - 4	1 - 8	1 - 7	1 - 15	1 - 12
Repetition accuracy of S <sub>n</sub>	%	3	1	2	1	1
Temperature drift of S <sub>n</sub>	%	10	10	10	10	10
Rated operational voltage	U <sub>a</sub>	15 - 30 V DC	15 - 30 V DC	15 - 30 V DC	15 - 30 V DC	15 - 30 V DC
Switching state display	LED	Red	Red	Red	Red	Red
Operating voltage display	LED	Green	Green	Green	Green	Green
Connection		3-wire/4-wire	3-wire/4-wire	3-wire/4-wire	3-wire/4-wire	3-wire/4-wire
Design (outer dimensions)	mm	M12 x 1	M12 x 1	M18 x 1	M18 x 1	M30 x 1.5
For connection of:						
...D01...		Plug-in connection M12 x 1				
...C02...		2 m connection cable				
Material		Stainless steel	Stainless steel	Stainless steel	Stainless steel	Stainless steel

Dimensions

Plug-in connection M12 x 1

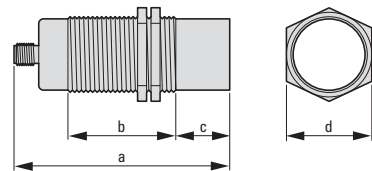

2 m connection cable

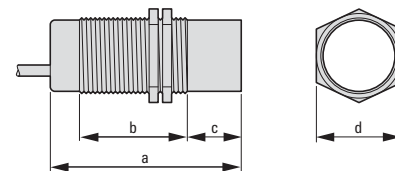

mm		a mm (inch)	b mm (inch)	c mm (inch)	d mm (inch)
∅ 12	①	77.5 (3.05)	50.3 (1.98)	0.5 (0.02)	17 (0.67)
	③	77.5 (3.05)	41.6 (1.64)	9 (0.36)	17 (0.67)
∅ 18	①	69.3 (2.73)	50.9 (2)	0.5 (0.02)	24 (0.94)
	③	69.3 (2.73)	37.4 (1.47)	14 (0.55)	24 (0.94)
∅ 30	①	74.1 (2.92)	54.1 (2.13)	0.75 (0.03)	36 (1.41)
	③	74.1 (2.92)	35.8 (1.41)	19 (0.75)	36 (1.41)

mm		a mm (inch)	b mm (inch)	c mm (inch)	d mm (inch)
∅ 12	①	62.4 (2.46)	50.3 (1.98)	0.5 (0.02)	17 (0.67)
	③	62.4 (2.46)	41.6 (1.64)	9 (0.36)	17 (0.67)
∅ 18	①	64.5 (2.54)	50.9 (2)	0.5 (0.02)	24 (0.94)
	③	64.5 (2.54)	37.4 (1.47)	14 (0.55)	24 (0.94)
∅ 30	①	69.6 (2.74)	54.1 (2.13)	0.75 (0.03)	36 (1.41)
	③	64.5 (2.54)	35.8 (1.41)	19 (0.75)	36 (1.41)

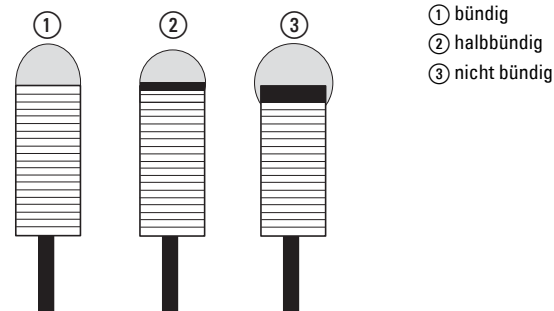

## Description

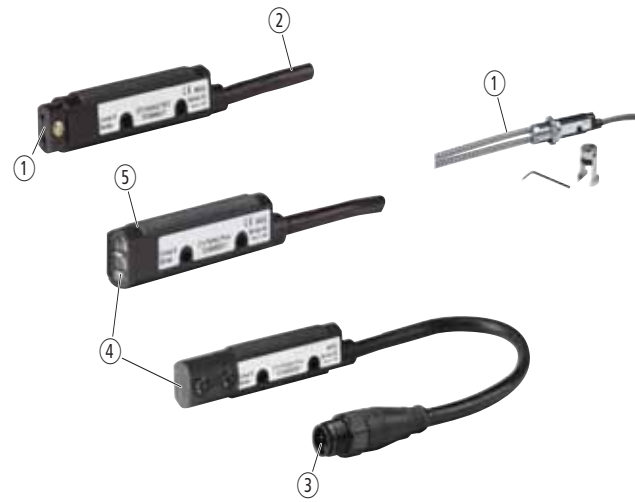

- ① F0 cable versions possible.
- ② Bright/dark selector switch on all models.
- ③ Models with M12 plug connector.
- ④ Sensing beam 0° or 90°.
- ⑤ Solid Polyurethane Body for Rugged Use.

## Short Description

Eaton's high-performance light barriers feature a tubular enclosure with a diameter of 18 mm and are available in a range of versions to solve virtually any sensing problem. The sensors are available in thru-beam, reflex, polarized reflex, diffuse reflective, focused diffuse reflective, wide-angle diffuse reflective, Perfect Prox<sup>®</sup>, Fine Spot Perfect Prox<sup>®</sup>, and fiber optic sensing versions. Perfect Prox<sup>®</sup> light barriers are among the most powerful on the market. These sensors can reliably detect targets of different color, reflectance, contrast or surface shape at the same range, while ignoring background objects just a fraction of an inch away. The Comet model series includes AC/DC and DC-only models with 2-, 3- and 4-wire circuitry, and with cable or M 12 micro-connector. Each light barrier features a Light/ Dark changeover switch and a gain control to provide for quick adjustment to peak optical performance. The unique threaded housing with flat sides allows quick mounting in a 3/4 mm hole or against any flat surface. Internal components are rigidly sealed in a solid encapsulated package for excellent performance in high vibration and high-shock applications.















## Product Features

- Industry standard 18 mm diameter threaded body has flat sides allowing it to be mounted like a tubular sensor or against any flat surface.
- Models with a 90° measurement direction can be installed in holes with a depth of only 152 mm.
- Perfect Prox<sup>®</sup> technology provides exceptional background rejection and application problem-solving.
- Visible sensing beams let you see where the light barrier is aimed for quick flush mounting and alignment.
- Solid polyurethane housing completely encapsulates internal circuits for high resistance to shock and vibration
- Adaptable modulation circuit provides immunity to crosstalk from other closely mounted sensors
- Models available with both AC and DC operation in a single unit – up to 264 volts AC.
- 4-wire DC sensors offer both NPN and PNP outputs.
- Output status indicator visible from a wide 270° angle.



## Approvals







Ordering

	Rated operational voltage $U_e$	Switching type	Rated switching distance $S_n$ mm	For connection of:	Description	Type of light	Part no. Article no.	Price see price list	Std. pack	
<b>Comet series</b>										
M18 x 1, Light/dark switching adjustable, Insulated material										
3-wire										
Thru-beam photoelectric sensor, Beam: straight										
	20 - 264 V AC 15 - 30 V DC	NPN	6000	2 m connection cable	Detector (for combination with source)	Visible red	12100A6513 135566		1 off  	
				Plug-in connection M12 x 1			12100AQD03 135568			
				24000			2 m connection cable			12102A6513 135574
				Plug-in connection M12 x 1			12102AQD03 135576			
			6000	2 m connection cable	Source (for combination with detector)	Visible red	11100A6513 135554			
				Plug-in connection M12 x 1			11100AQD03 135556			
				24000			2 m connection cable			11102A6513 135562
				Plug-in connection M12 x 1			11102AQD03 135564			
Thru-beam photoelectric sensor, Beam: right-angled										
	20 - 264 V AC 15 - 30 V DC	NPN	6000	2 m connection cable	Detector (for combination with source)	Visible red	12100R6513 135570		1 off  	
				Plug-in connection M12 x 1			12100RQD03 135572			
				2 m connection cable	Source (for combination with detector)	Visible red	11100R6513 135558			
				Plug-in connection M12 x 1			11100RQD03 135560			
Reflex photoelectric sensor, Beam: straight										
	20 - 264 V AC 15 - 30 V DC	NPN	4500	2 m connection cable	Polarized light for combination with reflector	Visible red	14101A6513 135646		1 off  	
				Plug-in connection M12 x 1			14101AQD03 135648			
				7600			2 m connection cable			for combination with reflector
			Plug-in connection M12 x 1	14100AQD03 135644						
			2 m connection cable	Visible red	14102A6513 135654					
			Plug-in connection M12 x 1		14102AQD03 135656					
Reflex photoelectric sensor, Beam: right-angled										
	20 - 264 V AC 15 - 30 V DC	NPN	3000	2 m connection cable	Polarized light for combination with reflector	Visible red	14101R6513 135650		1 off  	
				Plug-in connection M12 x 1			14101RQD03 135652			
			4500	2 m connection cable	for combination with reflector	Visible red	14102R6513 135658			
				Plug-in connection M12 x 1			14102RQD03 135660			
Reflected-light beam, Beam: focused, forward viewing										
	20 - 264 V AC 15 - 30 V DC	NPN	40	2 m connection cable		Visible red	13102A6513 135590		1 off  	
			40	Plug-in connection M12 x 1			13102AQD03 135592			

Information relevant for export to North America













 	Product Standards	UL 508; CSA-C22.2 No. 14; IEC60947-5-2; CE marking
	UL File No.	E117028
	UL CCN	NRKH, NRKH7
	CSA File No.	50513
	CSA Class No.	3211-07
	NA Certification	UL listed, CSA certified
	Max. Voltage Rating	264 V AC, 30 V DC
	Degree of Protection	IEC: IP68, IP69K; UL/CSA Type: 1, 4, 6



	Rated operational voltage $U_e$	Switching type	Rated switching distance $S_n$ mm	For connection of:	Description	Type of light	Part no. Article no.	Price see price list	Std. pack				
Reflected-light beam, Beam: straight													
	20 - 264 V AC 15 - 30 V DC	NPN	50	2 m connection cable	with background suppression (Perfect Prox)	Visible red	13104A6513 135602		1 off 				
				Plug-in connection M12 x 1			13104AQD03 135604						
			100	2 m connection cable	with background suppression (Perfect Prox) Fine Spot Sensors	Infra-red	13105A6513 135614						
				Plug-in connection M12 x 1			13105AQD03 135616						
			150	2 m connection cable	with background suppression (Perfect Prox)	Infra-red	13101A6513 135586						
				Plug-in connection M12 x 1			13101AQD03 135588						
			200	2 m connection cable	Expandable with fiber optic cable → Accessories	Infra-red	13107AS6513 135626						
				Plug-in connection M12 x 1			13107ASQD03 135628						
			225	2 m connection cable	with background suppression (Perfect Prox)	Infra-red	13108A6513 135634						
				Plug-in connection M12 x 1			13108AQD03 135636						
			610	2 m connection cable	Expandable with fiber optic cable → Accessories	Infra-red	13106A6513 135618						
				Plug-in connection M12 x 1			13106AQD03 135620						
			Reflected-light beam, Beam: right-angled										
				20 - 264 V AC 15 - 30 V DC	NPN	50	2 m connection cable	with background suppression (Perfect Prox)		Visible red	13104R6513 135606		1 off 
Plug-in connection M12 x 1	13104RQD03 135608												
100	Plug-in connection M12 x 1					Visible red	13104RS5003 135610						
	2 m connection cable						13104RS5013 135612						
150	2 m connection cable	with background suppression (Perfect Prox)				Infra-red	13107RS6513 135630						
	Plug-in connection M12 x 1						13107RSQD03 135632						
200	2 m connection cable	with background suppression (Perfect Prox)				Infra-red	13108R6513 135638						
	Plug-in connection M12 x 1						13108RQD03 135640						
225	2 m connection cable	with background suppression (Perfect Prox)				Infra-red	13106R6513 135622						
	Plug-in connection M12 x 1						13106RQD03 135624						
610	2 m connection cable	with background suppression (Perfect Prox)				Infra-red	13103R6513 135598						
	Plug-in connection M12 x 1						13103RQD03 135600						
610	2 m connection cable	with background suppression (Perfect Prox)				Infra-red	13100R6513 135582						
	Plug-in connection M12 x 1						13100RQD03 135584						

Information relevant for export to North America



	Product Standards	UL 508; CSA-C22.2 No. 14; IEC60947-5-2; CE marking
	UL File No.	E117028
	UL CCN	NRKH, NRKH7
	CSA File No.	50513
	CSA Class No.	3211-07
	NA Certification	UL listed, CSA certified
	Max. Voltage Rating	264 V AC, 30 V DC
	Degree of Protection	IEC: IP68, IP69K; UL/CSA Type: 1, 4, 6

	Rated operational voltage $U_e$	Switching type	Rated switching distance $S_n$ mm	For connection of:	Description	Type of light	Part no. Article no.	Price see price list	Std. pack	
<b>Comet series</b>										
M18 x 1, Light/dark switching adjustable, Insulated material										
4-wire										
	10 - 30 V DC	NPN PNP	6000	2 m connection cable	Detector (for combination with source)	Visible red	<b>12100A6517</b> 135567		1 off  	
				Plug-in connection M12 x 1			<b>12100AQD07</b> 135569			
				24000			2 m connection cable			<b>12102A6517</b> 135575
				Plug-in connection M12 x 1			<b>12102AQD07</b> 135577			
			6000	2 m connection cable	Source (for combination with detector)	Visible red	<b>11100A6517</b> 135555			
				Plug-in connection M12 x 1			<b>11100AQD07</b> 135557			
				24000			2 m connection cable			<b>11102A6517</b> 135563
				Plug-in connection M12 x 1			<b>11102AQD07</b> 135565			
	10 - 30 V DC	NPN PNP	6000	2 m connection cable	Detector (for combination with source)	Visible red	<b>12100R6517</b> 135571		1 off  	
				Plug-in connection M12 x 1			<b>12100RQD07</b> 135573			
			2 m connection cable	Source (for combination with detector)	Visible red	<b>11100R6517</b> 135559				
						Plug-in connection M12 x 1	<b>11100RQD07</b> 135561			
	10 - 30 V DC	NPN PNP	3000	2 m connection cable	Polarized light for combination with reflector	Visible red	<b>14101R6517</b> 135651		1 off  	
				Plug-in connection M12 x 1			<b>14101RQD07</b> 135653			
			4500	for combination with reflector	Visible red	<b>14102R6517</b> 135659				
						Plug-in connection M12 x 1	<b>14102RQD07</b> 135661			
	10 - 30 V DC	NPN PNP	4500	2 m connection cable	Polarized light for combination with reflector	Visible red	<b>14101A6517</b> 135647		1 off  	
				Plug-in connection M12 x 1			<b>14101AQD07</b> 135649			
			7600	for combination with reflector	Infra-red	<b>14100A6517</b> 135643				
						Plug-in connection M12 x 1	<b>14100AQD07</b> 135645			
			2 m connection cable	Visible red	<b>14102A6517</b> 135655					
					Plug-in connection M12 x 1	<b>14102AQD07</b> 135657				



Information relevant for export to North America



Product Standards	UL 508; CSA-C22.2 No. 14; IEC60947-5-2; CE marking
UL File No.	E117028
UL CCN	NRKH, NRKH7
CSA File No.	50513
CSA Class No.	3211-07
NA Certification	UL listed, CSA certified
Max. Voltage Rating	30 V DC
Degree of Protection	IEC: IP68, IP69K; UL/CSA Type: 1, 4, 6

Rated operational voltage $U_e$	Switching type	Rated switching distance $S_n$ mm	For connection of:	Description	Type of light	Part no. Article no.	Price see price list	Std. pack
<b>Comet series</b>								
M18 x 1, Light/dark switching adjustable, Insulated material								
Reflected-light beam, Beam: straight								
	10 - 30 V DC	NPN PNP	40	2 m connection cable	with background suppression (Perfect Prox)	Visible red	13102A6517 135591	1 off  
				Plug-in connection M12 x 1			13102AQD07 135593	
			50	2 m connection cable	with background suppression (Perfect Prox)	Visible red	13104A6517 135603	
				Plug-in connection M12 x 1			13104AQD07 135605	
				2 m connection cable	with background suppression (Perfect Prox) Fine Spot Sensors		13105A6517 135615	
				Plug-in connection M12 x 1			13105AQD07 135617	
			100	2 m connection cable	with background suppression (Perfect Prox)	Infra-red	13101A6517 135587	
				Plug-in connection M12 x 1			13101AQD07 135589	
			150	2 m connection cable			13107AS6517 135627	
				Plug-in connection M12 x 1			13107ASQD07 135629	
				2 m connection cable	with background suppression (Perfect Prox)		13108A6517 135635	
				Plug-in connection M12 x 1			13108AQD07 135637	
			200	2 m connection cable	Expandable with fiber optic cable → Accessories		13106A6517 135619	
				Plug-in connection M12 x 1			13106AQD07 135621	
225	2 m connection cable	with background suppression (Perfect Prox)		13103A6517 135595				
	Plug-in connection M12 x 1			13103AQD07 135597				
610	2 m connection cable	Expandable with fiber optic cable → Accessories		13100A6517 135579				
	Plug-in connection M12 x 1			13100AQD07 135581				

Information relevant for export to North America

 	Product Standards	UL 508; CSA-C22.2 No. 14; IEC60947-5-2; CE marking
	UL File No.	E117028
	UL CCN	NRKH, NRKH7
	CSA File No.	50513
	CSA Class No.	3211-07
	NA Certification	UL listed, CSA certified
	Max. Voltage Rating	30 V DC
	Degree of Protection	IEC: IP68, IP69K; UL/CSA Type: 1, 4, 6

Rated operational voltage $U_e$	Switching type	Rated switching distance $S_n$ mm	For connection of:	Description	Type of light	Part no. Article no.	Price see price list	Std. pack	
<b>Comet series</b>									
M18 x 1, Light/dark switching adjustable, Insulated material									
Reflected-light beam, Beam: right-angled									
	10 - 30 V DC	NPN PNP	50	2 m connection cable	with background suppression (Perfect Prox)	Visible red	13104R6517 135607	1 off	
				Plug-in connection M12 x 1					13104RQD07 135609
			100	Plug-in connection M12 x 1		Infra-red	13104RS5007 135611	13104RS5020 135613	
				2 m connection cable					
			150	2 m connection cable		Infra-red	13107RS6517 135631	13107RSQD07 135633	
				Plug-in connection M12 x 1					
				2 m connection cable	with background suppression (Perfect Prox)		13108R6517 135639	13108RQD07 135641	
				Plug-in connection M12 x 1					
			200	2 m connection cable		Infra-red	13106R6517 135623	13106RQD07 135625	
				Plug-in connection M12 x 1					
			225	2 m connection cable		Infra-red	13103R6517 135599	13103RQD07 135601	
				Plug-in connection M12 x 1					
610	2 m connection cable		Infra-red	13100R6517 135583	13100RQD07 135585				
	Plug-in connection M12 x 1								

Information relevant for export to North America

	Product Standards	UL 508; CSA-C22.2 No. 14; IEC60947-5-2; CE marking
	UL File No.	E117028
	UL CCN	NRKH, NRKH7
	CSA File No.	50513
	CSA Class No.	3211-07
	NA Certification	UL listed, CSA certified
	Max. Voltage Rating	30 V DC
	Degree of Protection	IEC: IP68, IP69K; UL/CSA Type: 1, 4, 6

**Description****Short Description**

Eaton's Plastic Fiber Optic Cables from offer a lower-cost alternative to glass fibers.











Single fiber optic cable is normally used for thru-beam sensing and duplex fiber optic cable (two isolated cables running in parallel) for diffuse reflective.

Pre-assembled fiber optic cables are special purpose cables to solve a variety of fiber optic sensing applications.















**Product Features**

- Fiber optic cables allow remote sensing in areas where space is restricted or tight viewing angles are required
- Single cable styles are ideal for thru-beam sensing.
- Duplex fiber optic cable styles are typically used for diffuse reflective sensing
- Pre-assembled cables are available in 0.5 mm for sensing extremely small targets

Ordering

	Design (outer dimensions) mm	Material	Sheathing	Part no. Article no.	Price see price list	Std. pack
<b>Glass fibre-Component adapter</b>						
In combination with reflex sensors 13106A... or 13100A... and E51KF fiber optic						
	-	Metal	-	<b>6235A-6501</b> 135759		1 off
<b>Glass fiber duplex cable</b>						
	2.4 Ø x 914	-	PVC	<b>E51KF163</b> 135761		1 off
	2.4 Ø x 914	-	Stainless steel	<b>E51KF563</b> 135783		
	1.6 Ø x 914	-	PVC	<b>E51KF183</b> 135763		
	1.6 Ø x 914	-	Stainless steel	<b>E51KF583</b> 135785		
	0.5 x 3.9 Ø x 914	-	PVC	<b>E51KF193</b> 135764		
	0.5 x 3.9 Ø x 914	-	Stainless steel	<b>E51KF593</b> 135786		
	3.2 Ø x 914	-	PVC	<b>E51KF323</b> 135771		
	3.2 Ø x 914	-	Stainless steel	<b>E51KF723</b> 135793		
	3.2 Ø x 914	-	PVC	<b>E51KF313</b> 135770		
	3.2 Ø x 914	-	Stainless steel	<b>E51KF713</b> 135792		
	0.8 x 9.7 Ø x 914	-	PVC	<b>E51KF343</b> 135773		
	0.8 x 9.7 Ø x 914	-	Stainless steel	<b>E51KF743</b> 135795		
	0.5 x 3.9 Ø x 914	-	Stainless steel	<b>E51KF553</b> 135782		
	0.5 x 3.9 Ø x 914	-	PVC	<b>E51KF153</b> 135760		
	1.6 Ø x 914	-	Stainless steel	<b>E51KF573</b> 135784		
	3.2 Ø x 914	-	Stainless steel	<b>E51KF733</b> 135794		
	1.6 Ø x 914	-	PVC	<b>E51KF173</b> 135762		
	3.2 Ø x 914	-	PVC	<b>E51KF333</b> 135772		
	3.2 Ø x 914	-	Stainless steel	<b>E51KF7A3</b> 135796		
	3.2 Ø x 914	-	PVC	<b>E51KF3A3</b> 135774		
	3.2 Ø x 914	-	Stainless steel	<b>E51KF7B3</b> 135797		
	3.2 Ø x 914	-	PVC	<b>E51KF3B3</b> 135775		



	Design (outer dimensions) mm	Material	Sheathing	Part no. Article no.	Price see price list	Std. pack
<b>Glass fiber simplex cable</b>						
	2.4 Ø x 914	-	Stainless steel	<b>E51KF663</b> 135788		1 off
	2.4 Ø x 914	-	PVC	<b>E51KF263</b> 135766		
	1.6 Ø x 914	-	Stainless steel	<b>E51KF683</b> 135790		
	1.6 Ø x 914	-	PVC	<b>E51KF283</b> 135768		
	0.5 x 3.9 Ø x 914	-	Stainless steel	<b>E51KF693</b> 135791		
	3.2 Ø x 914	-	Stainless steel	<b>E51KF823</b> 135799		
	3.2 Ø x 914	-	PVC	<b>E51KF423</b> 135777		
	0.5 x 3.9 Ø x 914	-	PVC	<b>E51KF293</b> 135769		
	3.2 Ø x 914	-	Stainless steel	<b>E51KF813</b> 135798		
	3.2 Ø x 914	-	PVC	<b>E51KF413</b> 135776		
	0.8 x 9.7 Ø x 914	-	Stainless steel	<b>E51KF843</b> 135801		
	0.8 x 9.7 Ø x 914	-	PVC	<b>E51KF443</b> 135779		
	0.5 x 3.9 Ø x 914	-	Stainless steel	<b>E51KF653</b> 135787		
	0.5 x 3.9 Ø x 914	-	PVC	<b>E51KF253</b> 135765		
	1.6 Ø x 914	-	Stainless steel	<b>E51KF673</b> 135789		
	3.2 Ø x 914	-	Stainless steel	<b>E51KF833</b> 135800		
	1.6 Ø x 914	-	PVC	<b>E51KF273</b> 135767		
	3.2 Ø x 914	-	PVC	<b>E51KF433</b> 135778		
	3.2 Ø x 914	-	Stainless steel	<b>E51KF8A3</b> 135802		
	3.2 Ø x 914	-	PVC	<b>E51KF4A3</b> 135780		
	3.2 Ø x 914	-	Stainless steel	<b>E51KF8B3</b> 135803		
	3.2 Ø x 914	-	PVC	<b>E51KF4B3</b> 135781		
<b>Safety bar</b>						
	-	Metal	-	<b>E58KS5200</b> 135757		1 off
<b>Fixing bracket</b>						
	53 x 44	Stainless steel	-	<b>6161AS5296</b> 135738		1 off
	53 x 44	Stainless steel	-	<b>6161AS5297</b> 135739		1 off

Engineering

Circuit diagrams

AC/DC Models (AC Connection)

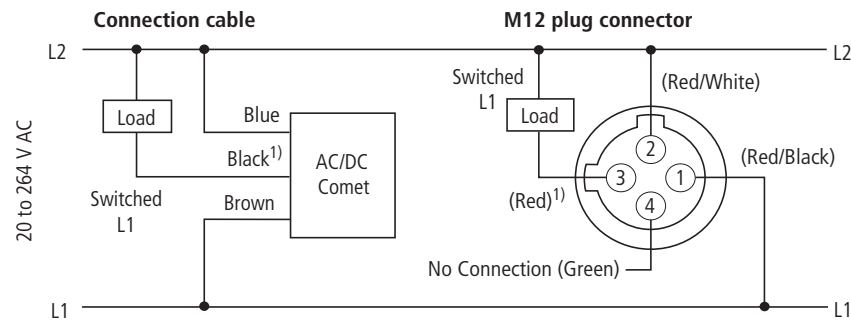

1) Note: Cable not connected on source of thru-beam sensors.

AC/DC Models (DC Connection)

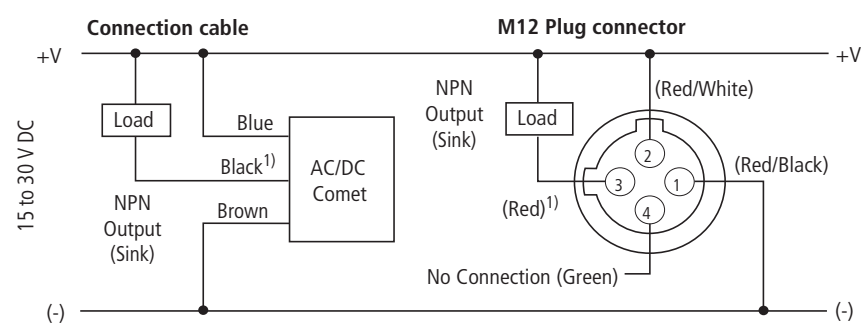

1) Note: Cable not connected on source of thru-beam sensors.

DC Models (DC Connection)

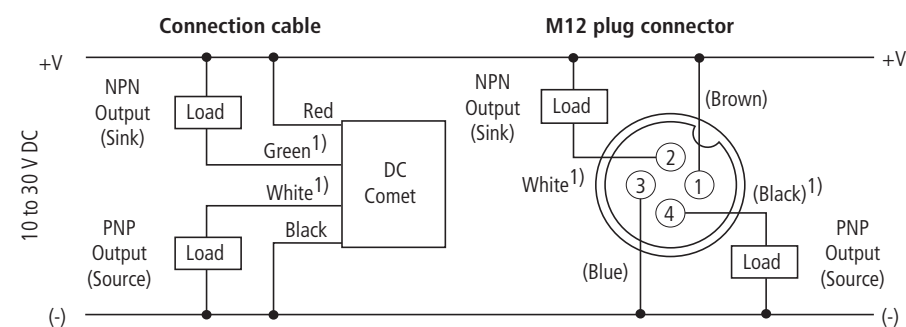

1) Note: Cable not connected on source of thru-beam sensors.

**Note:** AC/DC sensors have AC plug connectors. Take into account when using with DC voltage.

Function reserve chart

**Thru-beam photoelectric sensor**

- ① Detector 12100A and 12100R with source 11100A or 11100R
- ② Detector 12102A with source 11102A

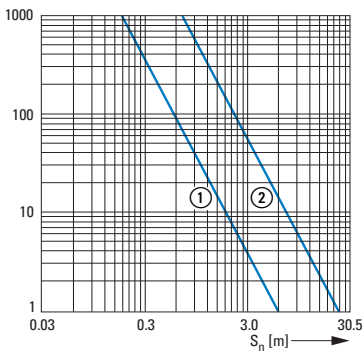

**Retroreflective sensing sensor**  
(84-mm-Reflector)

- ① 14100A/14102A
- ② 14102R
- ③ 14101A
- ④ 14101R

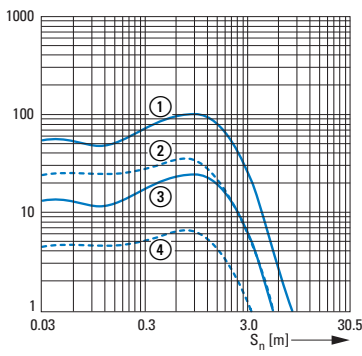

**Diffuse reflective sensor**  
(90% reflex test card)

- ⑤ 13107
- ⑥ 13100
- ⑦ 13106

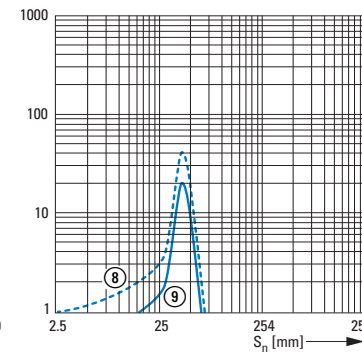
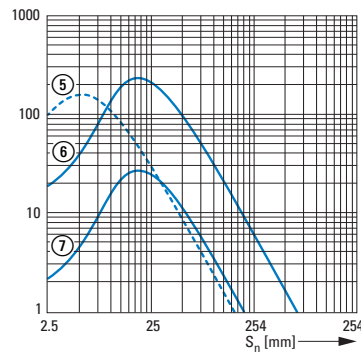

**Focused diffuse reflective sensor**  
(90% reflex test card)

- ⑧ 13102A typ.
- ⑨ 13102A minimum

**Perfect Prox®**

- ① 13108A/13108R
- ② 13104A
- ③ 14104RS

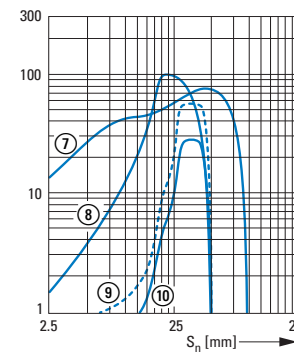
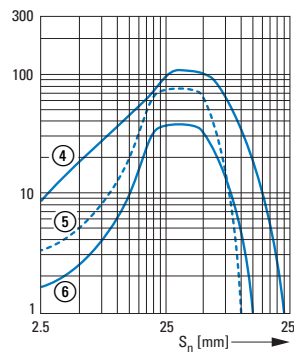
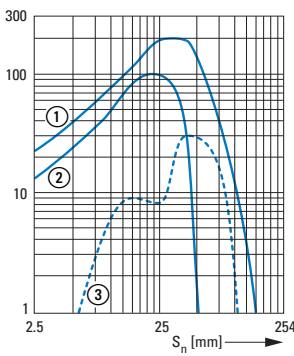

- ④ 13103A/13103R
- ⑤ 13101A typ.
- ⑥ 13101A minimum

- ⑦ 13102A typ.
- ⑧ 13102A min.
- ⑨ 13105A typ.
- ⑩ 13105A minimum

**Thru-beam photoelectric sensor**

- With single FO cable E51KF823
- ① 13100A Comet
- ② 13106A Comet

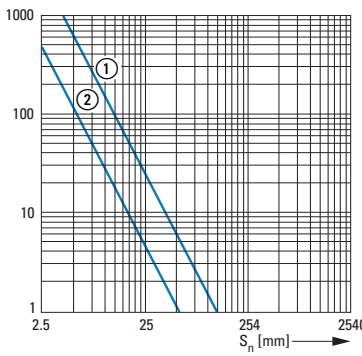

**Light switch**  
With duplex FO cable E51KF723

- ③ 13100A Comet
- ④ 13106A Comet

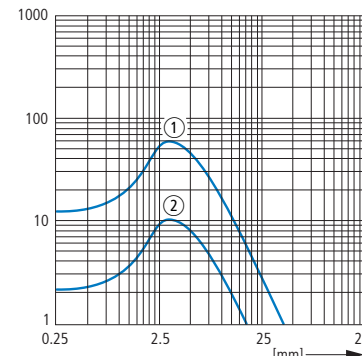

## Technical data

			3-wire 111-Part no.	121-Part no.	131-Part no.	141-Part no.
<b>General</b>						
Standards			IEC/EN 60947-5-2			
Ambient temperature	°C		- 20 - + 70	- 20 - + 70	- 40 - + 70	- 40 - + 70
Protection type			IP67	IP67	IP67	IP67
Mechanical shock resistance	g		100 Shock duration 3 ms			
<b>Characteristics</b>						
Rated operational voltage	$U_e$		20 - 264 V AC 15 - 30 V DC	20 - 264 V AC 15 - 30 V DC	20 - 264 V AC 15 - 30 V DC	20 - 264 V AC 15 - 30 V DC
Operating current in the switched state at 24 V DC	$I_b$	mA	30	30	30	30
Maximum load current	$I_e$	mA	< 300	< 300	< 300	< 300
Response time		ms	10	10	10	10
Switching state display		LED	Red	Red	Red	Red
Operating voltage display		LED	-	-	-	-
Protective functions			Short-circuit protective device Protection against polarity reversal			
Connection			3-wire	3-wire	3-wire	3-wire
Design (outer dimensions)	mm		M18 x 1	M18 x 1	M18 x 1	M18 x 1
For connection of:			2 m connection cable			
Material			Insulated material			

			4-wire 111-Part no.	121-Part no.	131-Part no.	141-Part no.
<b>General</b>						
Standards			IEC/EN 60947-5-2			
Ambient temperature	°C		- 20 - + 70	- 20 - + 70	- 40 - + 70	- 40 - + 70
Protection type			IP67	IP67	IP67	IP67
Mechanical shock resistance	g		100 Shock duration 3 ms			
<b>Characteristics</b>						
Rated operational voltage	$U_e$		10 - 30 V DC	10 - 30 V DC	10 - 30 V DC	10 - 30 V DC
Operating current in the switched state at 24 V DC	$I_b$	mA	25	30	30	30
Maximum load current	$I_e$	mA	PNP: 100 NPN: 250 (120 > 55 °C)	PNP: 100 NPN: 250 (120 > 55 °C)	PNP: 100 NPN: 250 (120 > 55 °C)	PNP: 100 NPN: 250 (120 > 55 °C)
Response time		ms	3.5	3.5	1	1
Switching state display		LED	-	Red	Red	Red
Operating voltage display		LED	red	-	-	-
Protective functions			Short-circuit protective device Protection against polarity reversal			
Connection			4-wire	4-wire	4-wire	4-wire
Design (outer dimensions)	mm		M18 x 1	M18 x 1	M18 x 1	M18 x 1
For connection of:			2 m connection cable			
Material			Insulated material			

**Notes** Further technical data can be found in the Online Catalog at <http://de.ecat.moeller.net>

Dimensions

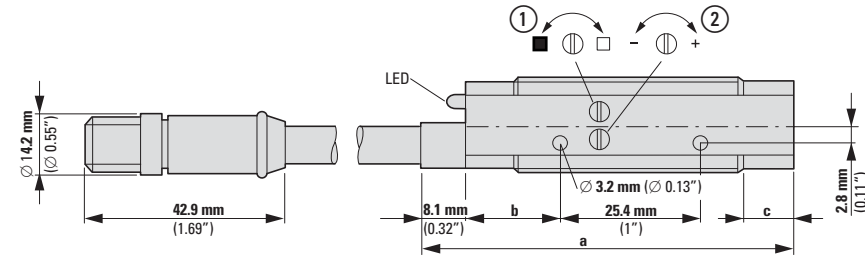

- ① Brightness setting
- ② Gain adjustment

Type	a_x mm (inch)_x	b_x mm (inch)_x	c_x mm (inch)_x	d_x mm (inch)_x	Settings		Enclosure style
					① Light/dark	② Gain	
11100A...	56 (2.2)	17 (0.67)	6 (0.24)	-	-	-	2
11100R...	65 (2.56)	17 (0.67)	15 (0.59)	5 (0.197)	-	-	4
11102A...	70 (2.78)	17 (0.67)	28 (1.10)	-	-	-	1
12100A...	56 (2.2)	17 (0.67)	6 (0.24)	-	x	x	2
12100R...	65 (2.56)	17 (0.67)	15 (0.59)	5 (0.197)	x	x	4
12102A...	66 (2.60)	15 (0.59)	7 (0.28)	-	x	x	1
13100A..., 13106A...	56 (2.2)	17 (0.67)	6 (0.24)	-	x	x	2
13100R..., 13106R...	65 (2.56)	17 (0.67)	15 (0.59)	5 (0.197)	x	x	4
13101A..., 13104A...	66 (2.60)	15 (0.59)	6 (0.24)	-	x	-	1
13102A..., 13103A..., 13105A..., 13108A...	66 (2.60)	15 (0.59)	6 (0.24)	-	x	x	1
13104R...	77 (3.03)	15 (0.59)	28 (1.10)	5 (0.197)	x	-	6
14100A..., 14102A...	66 (2.60)	15 (0.59)	7 (0.28)	-	x	x	1
14101R..., 14102R...	76 (2.99)	15 (0.59)	18 (0.71)	5 (0.197)	x	x	5
14101A...	67 (2.64)	15 (0.59)	7 (0.28)	-	x	x	1
15100A..., 15101A...	73 (2.87)	15 (0.59)	15 (0.59)	-	x	x	3

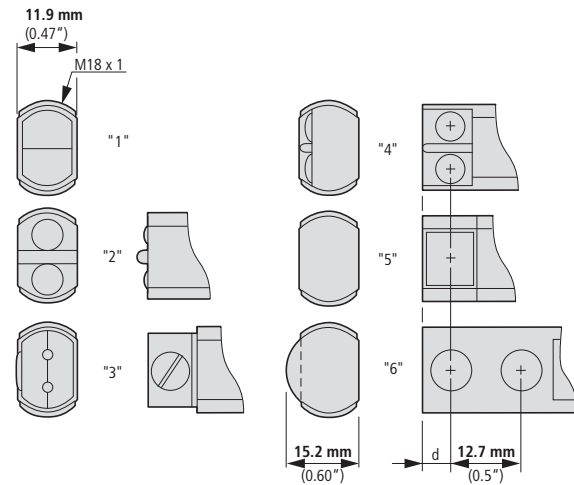

Enclosure style

Type	S_xn_x mm (inch)_x
13104A..., 13104R6..., 13104RQ..., 131055_x	50 (1.97)
13104RS..., 13101..._X	100 (3.94)
13107..., 13108...	150 (5.91)
13106...	200 (7.87)
13103...	225 (8.86)
13100...	610 (24.02)
14101R...	3000 (118.11)
14101A..., 14102R..._x	4500 (177.17)
11100..., 12100...	6000 (236.22)
14100A..., 14102A...	7600 (299.21)
11102..., 12102...	24000 (944.88)

Glass fiber duplex cable

E51KF313  
E51KF713

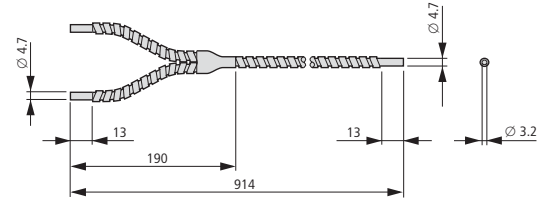

E51KF3B3  
E51KF7B3

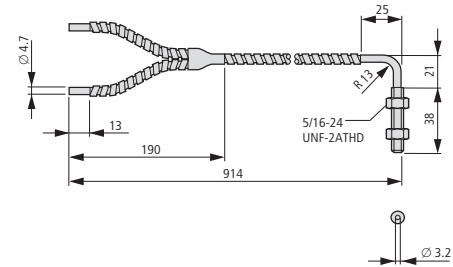

E51KF333  
E51KF733

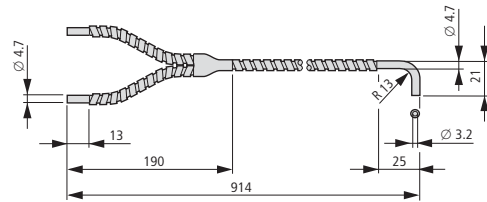

E51KF163  
E51KF563

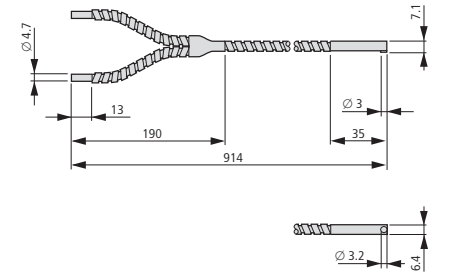

E51KF323  
E51KF723

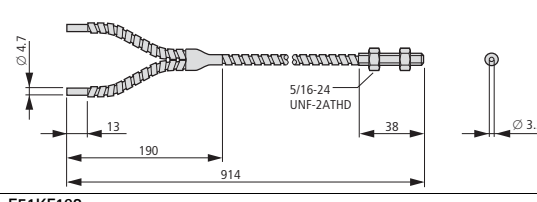

E51KF183  
E51KF583

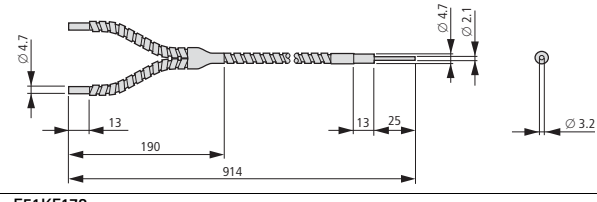

E51KF193  
E51KF593

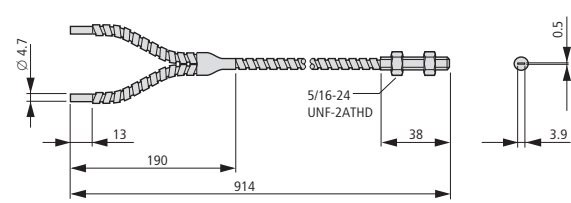

E51KF173  
E51KF573

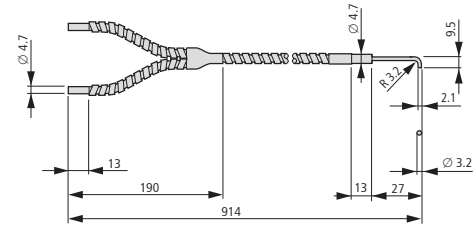

E51KF3A3  
E51KF7A3

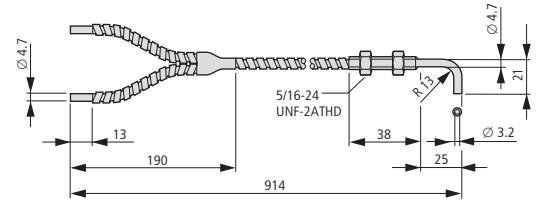

E51KF343  
E51KF743



E51KF153  
E51KF553

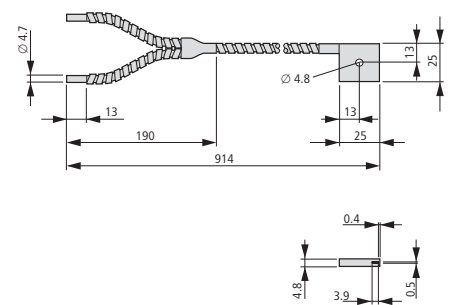



Glass fiber simplex cable

E51KF413  
E51KF813

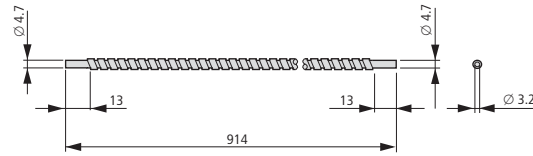

E51KF4B3  
E51KF8B3

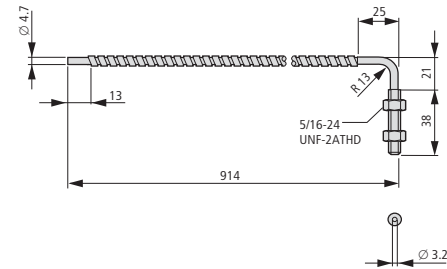

E51KF433  
E51KF833

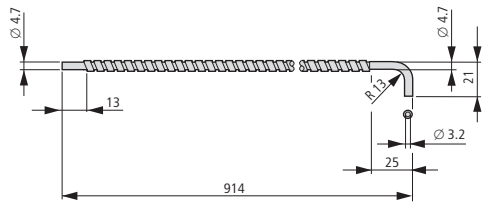

E51KF263  
E51KF663

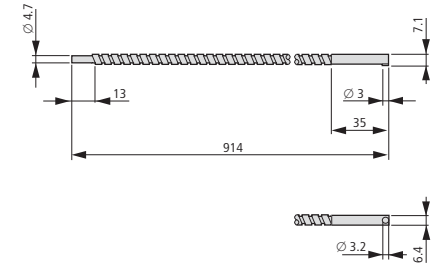

E51KF423  
E51KF823

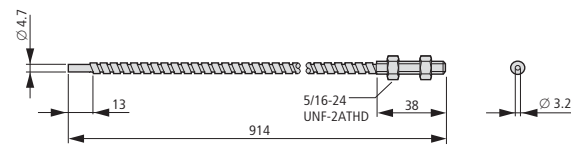

E51KF283  
E51KF683

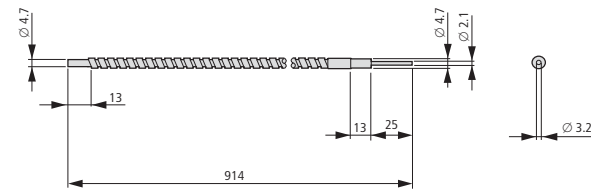

E51KF293  
E51KF693

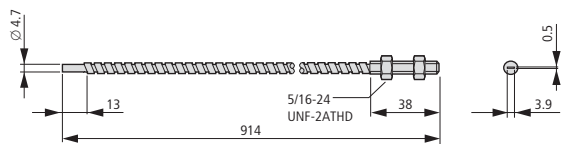

E51KF273  
E51KF673

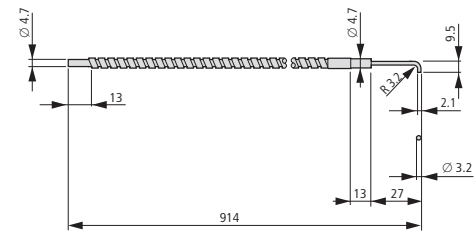

E51KF4A3  
E51KF8A3

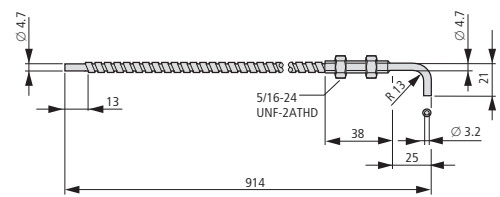

E51KF443  
E51KF843

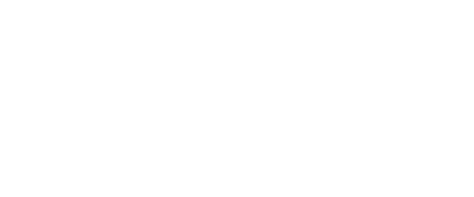

E51KF253  
E51KF653

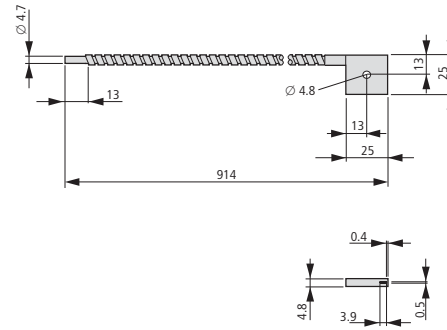

Safety bar, adjustable

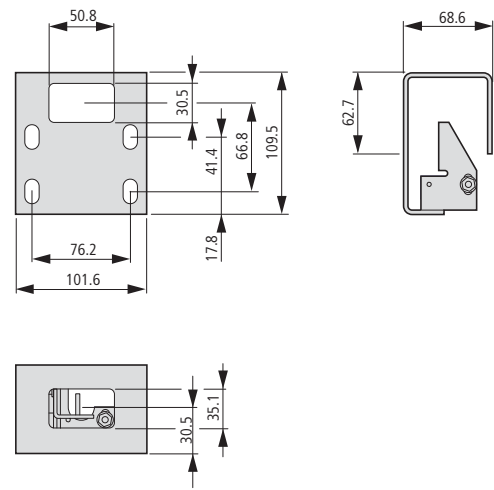

Clip-type fixing bracket, increased

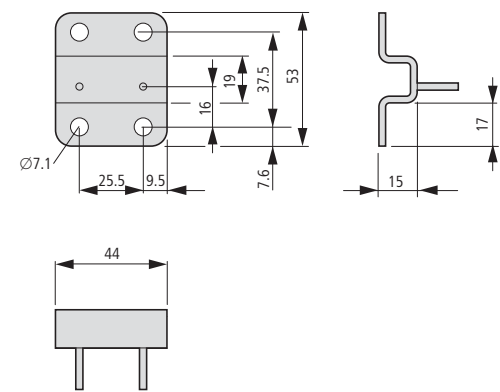

Clip-type fixing bracket, flat

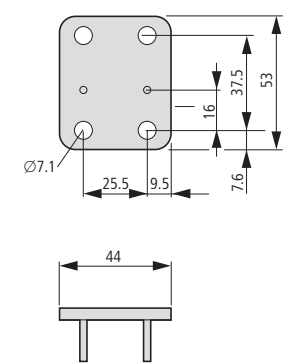

## Description



- ① Tempered Glass Lens Cover Protects Against Abrasion.
- ② Bright 360° function display.
- ③ All models with visible red light.
- ④ All models are available in versions with M12 (micro) plug connector.

## Short Description



Eaton's E58 series was designed to withstand harshest physical, chemical and optical environments. Stainless steel, PVDF and tempered glass components are mechanically assembled using Viton® seals to ensure complete sealing and resistance to industry chemicals. All adhesives and potting subject to failure from chemical attack have been eliminated from the design. The result is a sensor highly resistant to chemical attack and moisture intrusion, that can withstand heavy shock and vibration in almost any application. E58 Harsh Duty sensors feature unparalleled optical performance. They are ideal for automotive applications where exposure to lubricants, cutting fluids, coolants and glycols is common. For food processing applications, a smooth housing version simplifies high-pressure chemical washdowns. Furthermore it withstands the use of sanitizers, surfactants, and cleaning agents including diluted bases and acids.

## Product Features

- Sensor with a diameter of 18 mm and 30 mm.
- Highly refined optics for long sensing ranges and to see through high levels of contamination – unmatched optical performance
- Perfect Prox® technology provides exceptional background rejection and extremely high excess gain.
- Resistant to the wide range of chemicals used in the automotive, food processing and forest products industries
- Suitable for high temperature, high pressure washdown (82 bar).
- Mechanical Viton gaskets are resistant to extreme temperature variations.
- Visible sensing beam on all models lets you see where the beam is aimed for quick flush mounting and alignment.
- The function display is the brightest available and is visible from any angle and in any lighting condition
- The industry's only background suppression sensors with a 2-wire circuit design
- Four-wire DC sensors feature an NPN and a PNP output

## Approvals

















Con- nection	Design (outer dimen- sions) mm	Rated operational voltage U <sub>e</sub>	Rated switching distance S <sub>n</sub> mm	Switch- ing type	Switching principle	For connection of:	Type of light	Part no. Article no.	Price see price list	Std. pack	
<b>E58</b>											
Stainless steel											
Reflected-light beam with background suppression (Perfect Prox)											
	2-wire	M18 x 1	18 - 50 V DC	50	-	Dark switching	Plug-in connection M12 x 1	Visible red	<b>E58-18DP50-DDP</b> 135668	1 off  	
					-	Light switching			<b>E58-18DP50-DLP</b> 135669		
					100	-			Dark switching		<b>E58-18DP100-DDP</b> 135662
						-			Light switching		<b>E58-18DP100-DLP</b> 135663
					150	-			Dark switching		<b>E58-30DP150-DDP</b> 135674
						-			Light switching		<b>E58-30DP150-DLP</b> 135675

**Information relevant for export to North America**



Product Standards  
UL File No. E166051  
UL CCN NRKH, NRKH7  
CSA File No. UL report applies to both Canada and US  
CSA Class No. -  
NA Certification UL listed, certified by UL for use in Canada  
Max. Voltage Rating 50 V DC  
Degree of Protection IEC: IP68, IP69K; UL/CSA Type: 1, 2, 3, 3R, 3S, 4, 4x, 6, 6P, 12, 12K, 13

Con- nection	Design (outer dimen- sions) mm	Rated operational voltage U <sub>e</sub>	Rated switching distance S <sub>n</sub> mm	Switch- ing type	Switching principle	For connection of:	Type of light	Part no. Article no.	Price see price list	Std. pack	
<b>E58</b>											
Stainless steel											
Reflected-light beam with background suppression (Perfect Prox)											
	4-wire	M18 x 1	10 - 30 V DC	50	NPN PNP	Dark switching	2 m connection cable Plug-in connection M12 x 1	Visible red	<b>E58-18DP50-HD</b> 135670	1 off  	
						Light switching			<b>E58-18DP50-HLP</b> 135671		
						100			Dark switching		<b>E58-18DP50-HL</b> 135672
									Light switching		<b>E58-18DP50-HDP</b> 135673
						150			Dark switching		<b>E58-18DP100-HD</b> 135664
									Light switching		<b>E58-18DP100-HDP</b> 135665
				150	NPN PNP	2 m connection cable Plug-in connection M12 x 1	Visible red	<b>E58-18DP100-HL</b> 135666			
								<b>E58-18DP100-HLP</b> 135667			
								280	Dark switching		<b>E58-30DP150-HD</b> 135676
									Light switching		<b>E58-30DP150-HDP</b> 135677
								280	Dark switching		<b>E58-30DP150-HL</b> 135678
									Light switching		<b>E58-30DP150-HLP</b> 135679

Con- nection	Design (outer dimen- sions) mm	Rated operational voltage U <sub>e</sub>	Rated switching distance S <sub>n</sub> mm	Switch- ing type	Switching principle	For connection of:	Type of light	Part no. Article no.	Price see price list	Std. pack	
<b>E58</b>											
Stainless steel											
Reflex photoelectric sensor Polarized light for combination with reflector											
	4-wire	M30 x 1.5	10 - 30 V DC	10000	NPN PNP	Dark switching	2 m connection cable Plug-in connection M12 x 1	Visible red		1 off  	
											E58-30RP10-HD 135684
											E58-30RP10-HL 135686
E58-30RP10-HLP 135687											
	Reflex photoelectric sensor for combination with reflector										
	4-wire	M30 x 1.5	10 - 30 V DC	18000	NPN PNP	Dark switching	2 m connection cable Plug-in connection M12 x 1	Visible red		1 off  	
											E58-30RS18-HD 135688
											E58-30RS18-HL 135690
E58-30RS18-HLP 135691											
	Thru-beam photoelectric sensor Detector (for combination with source)										
	4-wire	M30 x 1.5	10 - 30 V DC	250000	NPN PNP	Dark switching	2 m connection cable Plug-in connection M12 x 1	-		1 off  	
											E58-30TD250-HD 135692
											E58-30TD250-HL 135694
E58-30TD250-HLP 135695											
	Thru-beam photoelectric sensor Source (for combination with detector)										
	4-wire	M30 x 1.5	10 - 30 V DC	250000	NPN PNP	-	2 m connection cable Plug-in connection M12 x 1	Visible red		1 off  	
											E58-30TS250-HA 135696

Information relevant for export to North America



Product Standards  
UL File No.  
UL CCN  
CSA File No.  
CSA Class No.  
NA Certification  
Max. Voltage Rating  
Degree of Protection

UL 508; CSA-C22.2 No. 14; IEC60947-5-2; CE marking  
E166051  
NRKH, NRKH7  
UL report applies to both Canada and US  
-  
UL listed, certified by UL for use in Canada  
30 V DC  
IEC: IP68, IP69K; UL/CSA Type: 1, 2, 3, 3R, 3S, 4, 4x, 6, 6P, 12, 12K, 13

Engineering

Circuit diagrams

E58...HA

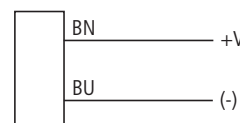

E58...HAP

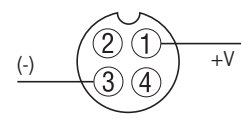

E58...DDP, E58...DLP

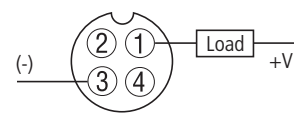

E58...HD  
E58...HL

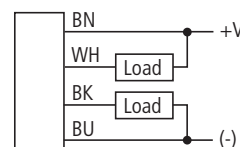

E58...HDP  
E58...HLP

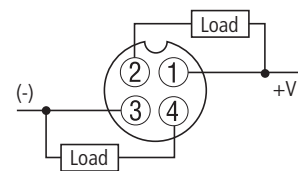

Function reserve chart

- One-way light barrier**  
 ① One-way light barrier  
**Reflex**  
 ② 84-mm-Reflector  
**Polarized reflex**  
 ③ 84-mm-Reflector

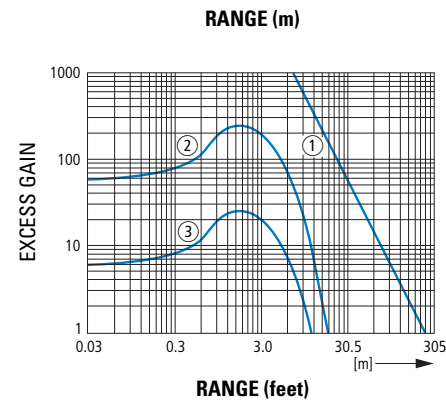

- Perfect Prox®**  
 ① 18 mm Diameter, 50-mm-Designs  
 ② 18 mm Diameter, 100-mm-Designs  
 ③ 30 mm Diameter, 150-mm-Designs  
 ④ 30 mm Diameter, 280-mm-Design

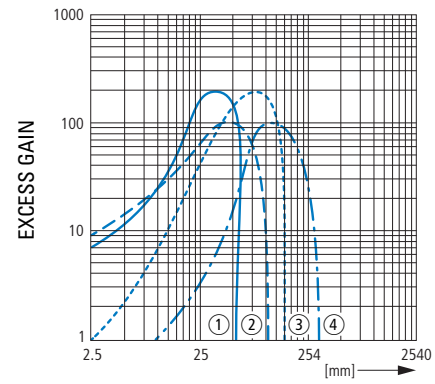

Dimensions

E58-Serie

E58-18...

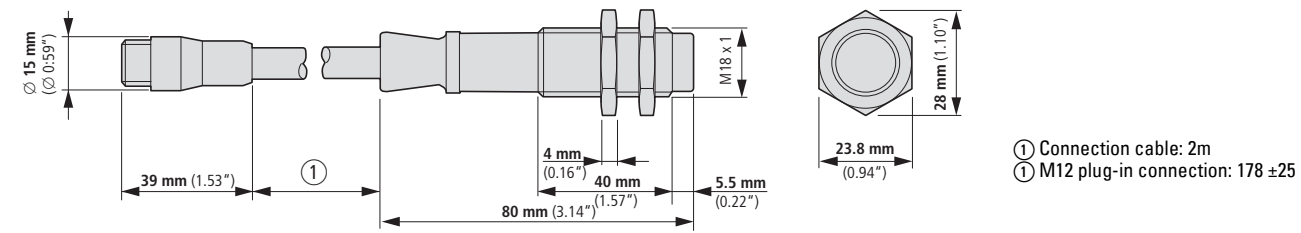

E58-30...

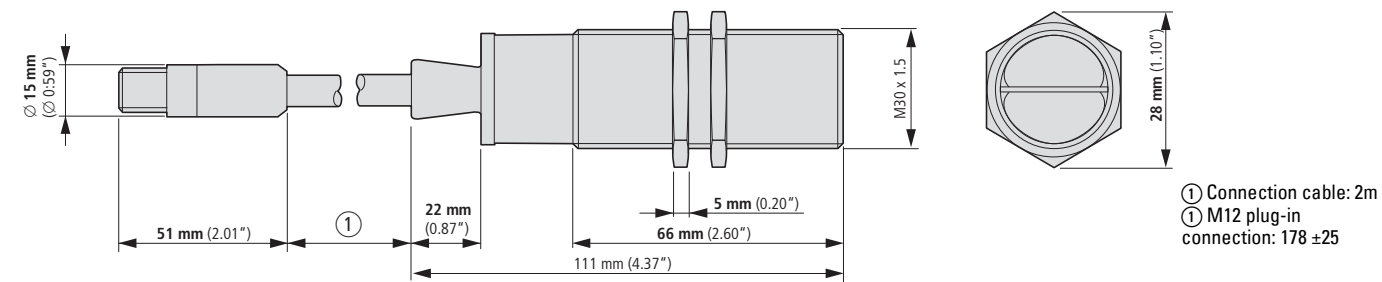

Technical data

	2-wire		4-wire	
	E58-18...	E58-30...	E58-18...	E58-30...DP150
<b>General</b>				
Standards	IEC/EN 60947-5-2			
Ambient temperature	°C	- 40 - + 70	- 25 - + 55	- 40 - + 55
Protection type	IP69K			
Mechanical shock resistance	g	100 Shock duration 3 ms		
<b>Characteristics</b>				
Rated operational voltage	U <sub>e</sub>	18 - 50 V DC	18 - 50 V DC	10 - 30 V DC
Operating current in the switched state at 24 V DC	I <sub>b</sub>	1.7	1.7	-
Maximum load current	I <sub>e</sub>	100	300	PNP: 100 NPN: 250
Response time	ms	35	35	1
Switching state display	LED	Red	Red	Red
Protective functions	Short-circuit protective device			
<b>Connection</b>				
Design (outer dimensions)	mm	M18 x 1	M30 x 1.5	M18 x 1
Material		Stainless steel	Stainless steel	Stainless steel

**Notes** Further technical data can be found in the Online Catalog at <http://de.ecat.moeller.net>



## Description



- ① 18 mm thread
- ② Voltage LED (green)
- ③ Output LED (red)
- ④ Targetlock™ LED (orange)
- ⑤ Gain adjustment

## Short Description

Eaton's SM series photoelectric sensors offer a high performance and simple use in a compact, cost-effective design. Regardless how good a sensor's performance just a slight maladjustment or incorrectly positioned target will sooner or later impact reliability. TargetLock™ not only simplifies sensor setup but visually confirms your sensor is positioned to operate with the highest possible reliability. In addition TargetLock™ outputs diagnostic information during operation, which provide an early warning about potential problems to help prevent costly downtimes. The SM Series includes many other features that simplify use. Visible sensing beams on all models show you exactly where the sensors are pointing. The durable enclosure features multiple fixing possibilities to easily fit on your equipment in the tightest of spaces. Full protection from overvoltage, reverse polarity and short circuits reduces the chance of damage. Bright 360° LED indicators clearly show sensor status.





## Product Features

- Bright indicators for current, output, and TargetLock™.
- TargetLock™ simplifies setup and ensures a high operational reliability.
- Perfect Prox® models detect targets with different colors at the same range while ignoring background objects.
- AC/DC models work with 18 – 264 V AC or 18 – 50 V DC.
- DC-only models feature PNP and NPN outputs.
- Visible sensing beam on all models lets you see where the beam is aimed for quick flush mounting and alignment.
- Compact design for space-saving flush mounting.
- Range of mounting options, including standard 18 mm thread.
- Short-circuit, overload and protection against polarity reversal.
- Full family includes thru-beam, polarized reflex, diffuse reflective and Perfect Prox® background rejection.

## Approvals

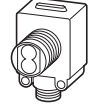

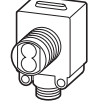
Ordering

	Rated operational voltage $U_e$	Description	Rated switching distance $S_n$ mm	Switching type	Switching principle	For connection of:	Part no. Article no.	Price see price list	Std. pack	
<b>E65-SM</b>										
4-wire Reflected-light beam Insulated material										
	10 - 30 V DC	with background suppression (Perfect Prox)	50	NPN PNP	Dark switching	2 m connection cable Plug-in connection M12 x 1	<b>E65-SMPP050-HD</b> 135702		1 off  	
					Light switching	2 m connection cable Plug-in connection M12 x 1	<b>E65-SMPP050-HL</b> 135704			
				NPN PNP	Dark switching	2 m connection cable Plug-in connection M12 x 1	<b>E65-SMPP100-HD</b> 135710			
					Light switching	2 m connection cable Plug-in connection M12 x 1	<b>E65-SMPP100-HL</b> 135712			
			200	-	NPN PNP	Dark switching	2 m connection cable Plug-in connection M12 x 1			<b>E65-SMSD200-HD</b> 135726
						Light switching	2 m connection cable Plug-in connection M12 x 1			<b>E65-SMSD200-HL</b> 135728
	10 - 30 V DC	Polarized light for combination with reflector	3000	NPN PNP	Dark switching	2 m connection cable Plug-in connection M12 x 1	<b>E65-SMPR3-HD</b> 135718		1 off  	
					Light switching	2 m connection cable Plug-in connection M12 x 1	<b>E65-SMPR3-HL</b> 135720			
				NPN PNP	Dark switching	2 m connection cable Plug-in connection M12 x 1	<b>E65-SMPR3-HDD</b> 135719			
					Light switching	2 m connection cable Plug-in connection M12 x 1	<b>E65-SMPR3-HLD</b> 135721			
			15000	Detector (for combination with source)	NPN PNP	Dark switching	2 m connection cable Plug-in connection M12 x 1			<b>E65-SMTD15-HD</b> 135730
						Light switching	2 m connection cable Plug-in connection M12 x 1			<b>E65-SMTD15-HL</b> 135732
15000	Source (for combination with detector)	NPN PNP	Light switching	2 m connection cable Plug-in connection M12 x 1	<b>E65-SMTD15-HDD</b> 135731					
			-	2 m connection cable	<b>E65-SMTD15-HLD</b> 135733					
-	-	-	-	2 m connection cable	<b>E65-SMTS15-HA</b> 135734					
-	-	-	-	Plug-in connection M12 x 1	<b>E65-SMTS15-HAD</b> 135735					

Information relevant for export to North America



Product Standards  
UL File No.  
UL CCN  
CSA File No.  
CSA Class No.  
NA Certification  
Max. Voltage Rating  
Degree of Protection

UL 508; CSA-C22.2 No. 14; IEC60947-5-2; CE marking  
E166051  
NRKH, NRKH7  
UL report applies to both Canada and US  
-  
UL listed, certified by UL for use in Canada  
132 V AC, 30 V DC  
IEC: IP68, IP69K; UL/CSA Type: 1, 3, 4, 4x, 6, 6P, 12, 13

## Technical data

			E65...50-H...	E65...15-H...	E65...-HA...
<b>General</b>					
Standards			IEC/EN 60947-5-2		
Ambient temperature			-	-	-
Operation	$\theta$	°C	-25 - +55	-25 - +55	-25 - +55
Storage	$\theta$	°C	-25 - +70	-25 - +70	-25 - +70
Protection type			IP68, IP69K	IP68, IP69K	IP68, IP69K
Mechanical shock resistance		g	50 Shock duration 10 ms		
<b>Characteristics</b>					
Rated operational voltage		$U_e$	10 - 30 V DC	10 - 30 V DC	10 - 30 V DC
Operating current in the switched state at 24 V DC	$I_b$	mA	20	20	40
Maximum load current	$I_e$	mA	100	100	100
Switching Frequency		Hz	-	-	-
Switching state display		LED	Red	Red	Red
Operating voltage display		LED	Green	Green	Green
Boundary gain			Yellow	Yellow	Yellow
Protective functions			Short-circuit protective device Protection against polarity reversal Protection against wire breakage		
Connection			4-wire	4-wire	4-wire
Design (outer dimensions)		mm	33 x 41 x 37	33 x 41 x 37	33 x 41 x 37
Material			Insulated material	Insulated material	Insulated material

## Notes

Further technical data can be found in the Online Catalog at <http://de.ecat.moeller.net>

Engineering

Circuit diagrams

E65...HA



E65...HAD

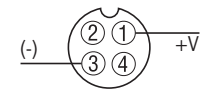

E65...HD  
E65...HL

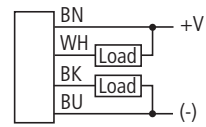

E65...HDD  
E65...HLD

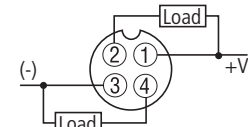

Function reserve chart

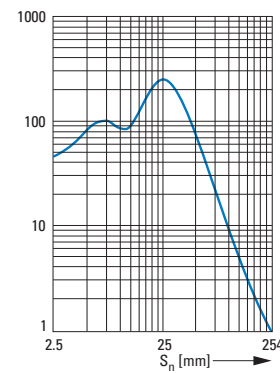
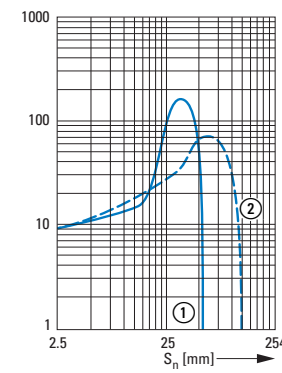
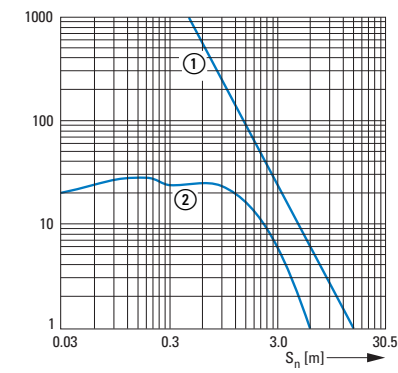

- ① One-way light barrier
- ② Retroreflective sensing sensor with polarization filter

- ① 50 mm Perfect Prox®
- ② 100 mm Perfect Prox®

- ① Light switch
- ② 90% reflection test card

Dimensions

E65-SM-Series

E65...-HD  
E65...-HL  
E65...-HA

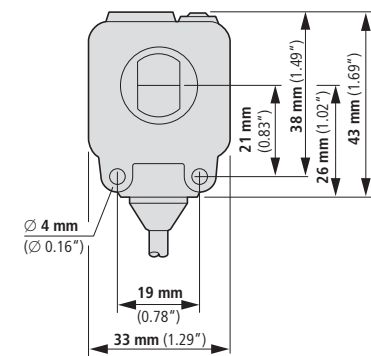

E65...-HDD  
E65...-HLD  
E65...-HAD

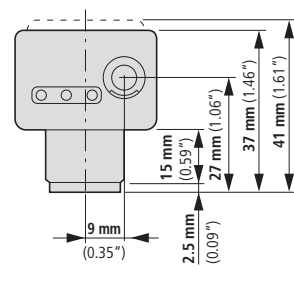
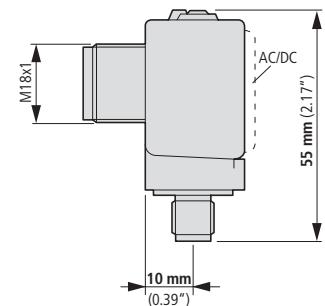

**Description****Short Description**

The E67 Long Range Perfect Prox series includes long-range sensors with background suppression, making it ideal for demanding sensing applications. E67 Long Range Perfect Prox sensors will reliably detect target objects within their sensing range regardless of variations in color, reflectance, contrast, or surface shape. Accordingly, they will simply ignore objects that are just outside their target range.

**Product Features**

- Perfect Prox technology provides exceptional background rejection and application problem solving
- Sensing ranges of 60 to 240 cm are available.
- No user adjustments required.
- Dual indicators communicate both output and power status from an easy-to-see location at the top of the sensor enclosure
- The DC sensors come with NPN and PNP outputs.
- Two mounting options for maximum flexibility
- Fully sealed enclosure.

**Approvals**

Ordering

Rated switching distance $S_n$ mm	Switching type	Type of light	Light switching		Dark switching		Std. pack
			Part no. Article no.	Price see price list	Part no. Article no.	Price see price list	
<b>E67</b> mit Hintergrundausbildung (Perfect Prox) 4-Draht Reflexlichtschranke Bemessungsbetriebsspannung $U_b$ 18 - 30 V DC Plug-in connection M12 x 1							
600	NPN PNP	Infra-red	<b>E67-LRDP060-HLD</b> 100540		<b>E67-LRDP060-HDD</b> 100539		1 off
700			<b>E67-LRDP070-HLD</b> 100542		<b>E67-LRDP070-HDD</b> 100541		
800			<b>E67-LRDP080-HLD</b> 100544		<b>E67-LRDP080-HDD</b> 100543		
900			<b>E67-LRDP090-HLD</b> 100546		<b>E67-LRDP090-HDD</b> 100545		
1000			<b>E67-LRDP100-HLD</b> 100548		<b>E67-LRDP100-HDD</b> 100547		
1100			<b>E67-LRDP110-HLD</b> 100550		<b>E67-LRDP110-HDD</b> 100549		
1200			<b>E67-LRDP120-HLD</b> 100552		<b>E67-LRDP120-HDD</b> 100551		
1300			<b>E67-LRDP130-HLD</b> 100554		<b>E67-LRDP130-HDD</b> 100553		
1400			<b>E67-LRDP140-HLD</b> 100556		<b>E67-LRDP140-HDD</b> 100555		
1500			<b>E67-LRDP150-HLD</b> 100558		<b>E67-LRDP150-HDD</b> 100557		
1600			<b>E67-LRDP160-HLD</b> 100560		<b>E67-LRDP160-HDD</b> 100559		
1700			<b>E67-LRDP170-HLD</b> 100562		<b>E67-LRDP170-HDD</b> 100561		
1800			<b>E67-LRDP180-HLD</b> 100564		<b>E67-LRDP180-HDD</b> 100563		
1900			<b>E67-LRDP190-HLD</b> 100566		<b>E67-LRDP190-HDD</b> 100565		
2000			<b>E67-LRDP200-HLD</b> 100568		<b>E67-LRDP200-HDD</b> 100567		
2100			<b>E67-LRDP210-HLD</b> 100570		<b>E67-LRDP210-HDD</b> 100569		
2200	<b>E67-LRDP220-HLD</b> 100572		<b>E67-LRDP220-HDD</b> 100571				
2300	<b>E67-LRDP230-HLD</b> 100574		<b>E67-LRDP230-HDD</b> 100573				
2400	<b>E67-LRDP240-HLD</b> 100576		<b>E67-LRDP240-HDD</b> 100575				

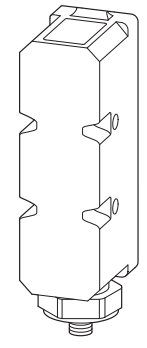

Dimensions

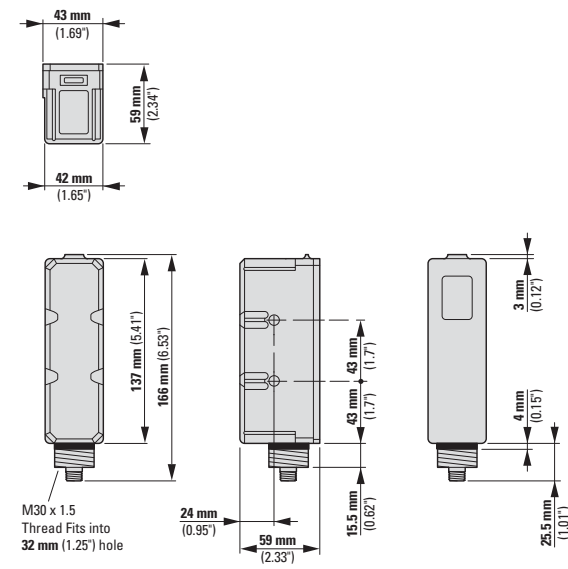



Engineering

Signal reserve

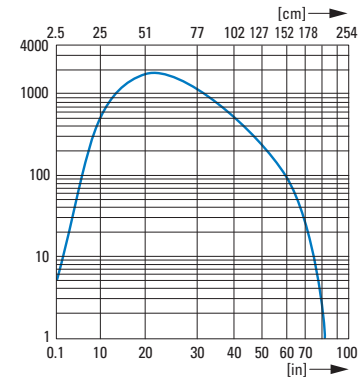

① This fixed sensing range is printed on the product label. Other ranges are available from Eaton upon request.

Circuit diagram

Connector Version - Face view male

AC/DC<sup>1)2)</sup> Isolated outputs

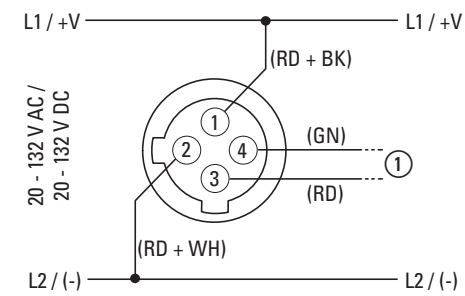

DC current<sup>1)</sup>  
NPN & PNP

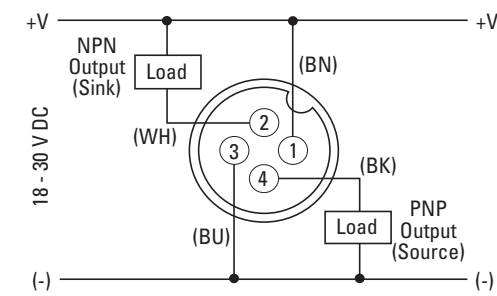

→ DIN IEC 304, DIN IEC 757

BK	Black
BN	Brown
BU	Blue
GN	Green
RD	Red
WH	white

<sup>1)</sup> Connector Versions: The pin numbering and wire colors are typical of several manufacturers, however, variations are possible. In case of discrepancies, rely on function indicated and pin location rather than pin number or wire color.

<sup>2)</sup> Isolated output can switch AC or DC loads in either AC or DC operating modes.

Technical data

			E67
<b>General</b>			
Ambient temperature		°C	
Operation	θ	°C	-35 - + 55
Storage	θ	°C	-40 - +70
Protection type			IP67
Mechanical shock resistance		g	30 Shock duration 6 ms
Vibration			10 g (10 Hz - 2 kHz)
<b>Characteristics</b>			
Rated operational voltage		U <sub>e</sub>	18 - 30 V DC
Maximum load current	I <sub>e</sub>	mA	< 100
Response time		ms	15
Switching state display		LED	Red
Operating voltage display		LED	Green
Connection			4-wire
Design (outer dimensions)		mm	Rectangular (166 x 59 x 43)
For connection of:			Plug-in connection M12 x 1

**Description****Short Description**

The NanoView™ Series from Eaton is a family of miniature rectangular photoelectric sensors designed for optimum value and sensing performance in a wide range of applications.

These small sensors are available for a wide variety of optical operating modes: retroreflective sensing sensor, diffuse reflective sensor, and thru-beam photoelectric sensor. They can even be used to detect transparent objects, such as plastic bottles, molded parts, containers, and films. NanoView sensors are housed in ABS enclosures rated IP66 or better. Two top-mounted indicator LEDs communicate power and output status.



Each model includes both light operate and dark operate modes. Termination options include a 4-pole M8 connector cable or a built-in 6 ft (2m) cable. NanoView is the ultimate solution to sensing challenges that require reduced dimensions and costs.

**Product Features**

- Complete range.
- Small size: With a length of less than 38 mm and a depth of 13 mm, NanoView sensors can fit pretty much anywhere.
- Models with focused beam path: A focal length of 100 mm makes them perfect for detecting small target objects. In addition, a visible red LED beam makes them easy to set up.

**Approvals**

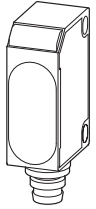
Ordering

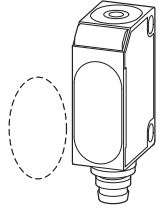
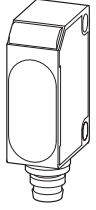
Description	Rated operational voltage $U_e$	Switching principle	Rated switching distance $S_n$ mm	Switching type	For connection of:	Type of light	Part no. Article no.	Price see price list	Std. pack
<b>E71-Serie NanoView</b> 4-wire									
 <p>Thru-beam photoelectric sensor</p>	Source (for combination with detector)	Light/dark switching adjustable	1500	9999999	Plug-in connection M8 x 1	Infra-red	<b>E71-NTBS-M8<sup>1)</sup></b> 100522	1 off  	
				9999999	2 m connection cable		<b>E71-NTBS-CA<sup>1)</sup></b> 100521		
				9999999	Plug-in connection M8 x 1		<b>E71-TBS-M8<sup>1)</sup></b> 100536		
				9999999	2 m connection cable		<b>E71-TBS-CA<sup>1)</sup></b> 100535		
	Detector (for combination with source)	Light/dark switching adjustable	6000	NPN	Plug-in connection M8 x 1	Infra-red	<b>E71-TBRN-M8<sup>1)</sup></b> 100532		
				NPN	2 m connection cable		<b>E71-TBRN-CA<sup>1)</sup></b> 100531		
				PNP	Plug-in connection M8 x 1		<b>E71-TBRP-M8<sup>1)</sup></b> 100534		
				PNP	2 m connection cable		<b>E71-TBRP-CA<sup>1)</sup></b> 100533		
 <p>Reflex photoelectric sensor</p>	for combination with reflector Detecting transparent objects	Light/dark switching adjustable	800	NPN	Plug-in connection M8 x 1	Visible red	<b>E71-CO-N-M8<sup>2)</sup></b> 100426		
				NPN	2 m connection cable		<b>E71-CO-N-CA<sup>2)</sup></b> 100069		
				PNP	Plug-in connection M8 x 1		<b>E71-CO-P-M8<sup>2)</sup></b> 100428		
				PNP	2 m connection cable		<b>E71-CO-P-CA<sup>2)</sup></b> 100427		
	for combination with reflector (polarized light)	Light/dark switching adjustable	2500	PNP	Plug-in connection M8 x 1	Visible red	<b>E71-PRP-M8<sup>2)</sup></b> 100526		
				PNP	2 m connection cable		<b>E71-PRP-CA<sup>2)</sup></b> 100525		
				NPN	Plug-in connection M8 x 1		<b>E71-PRN-M8<sup>2)</sup></b> 100524		
				NPN	2 m connection cable		<b>E71-PRN-CA<sup>2)</sup></b> 100523		
 <p>Reflected-light beam</p>	Beam: focused, forward viewing	Light/dark switching adjustable	100	NPN	Plug-in connection M8 x 1	Visible red	<b>E71-FFDN-M8<sup>1)</sup></b> 100511		
				NPN	2 m connection cable		<b>E71-FFDN-CA<sup>1)</sup></b> 100429		
				PNP	2 m connection cable		<b>E71-FFDP-CA<sup>1)</sup></b> 100517		
				PNP	Plug-in connection M8 x 1		<b>E71-FFDP-M8<sup>1)</sup></b> 100518		
	Beam: straight	Light/dark switching adjustable	350	NPN	Plug-in connection M8 x 1	Infra-red	<b>E71-SDN-M8<sup>2)</sup></b> 100528		
				NPN	2 m connection cable		<b>E71-SDN-CA<sup>2)</sup></b> 100527		
				PNP	Plug-in connection M8 x 1		<b>E71-SDP-M8<sup>2)</sup></b> 100530		
				PNP	2 m connection cable		<b>E71-SDP-CA<sup>2)</sup></b> 100529		

Information relevant for export to North America



- 1) Product Standards  
UL File No.  
UL CCN  
CSA File No.  
NA Certification  
Max. Voltage Rating  
Degree of Protection
  - 2) Product Standards  
UL File No.  
UL CCN  
CSA File No.  
NA Certification  
Max. Voltage Rating  
Degree of Protection
- UL 508; CSA-C22.2 No. 14; IEC60947-5-2; CE marking  
E166051  
NRKH, NRKH7  
UL report applies to both Canada and US  
UL listed, certified by UL for use in Canada  
30 V DC  
IEC: IP67; UL/CSA Type: -
- UL 508; CSA-C22.2 No. 14; IEC60947-5-2; CE marking  
E166051  
NRKH, NRKH7  
UL report applies to both Canada and US  
UL listed, certified by UL for use in Canada  
30 V DC  
IEC: IP66; UL/CSA Type: -

Engineering

Charts

E71-P

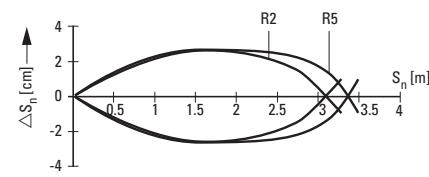

R2 = 48-mm reflector, R5 = 75-mm reflector

E71-F

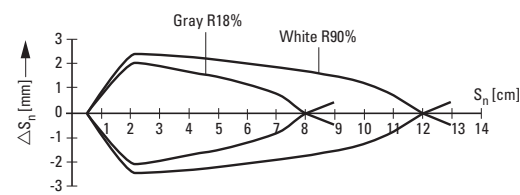

E71-S

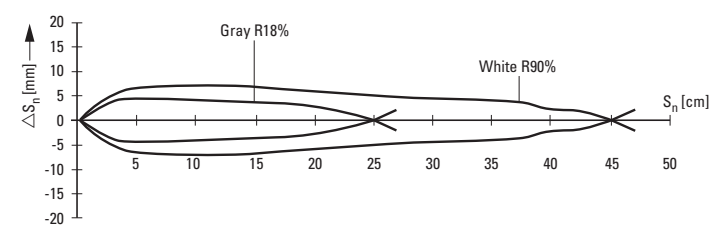

E71-C

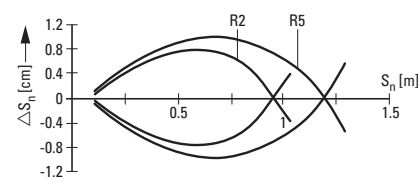

R2 = 48-mm reflector, R5 = 75-mm reflector

Circuit diagrams

NPN

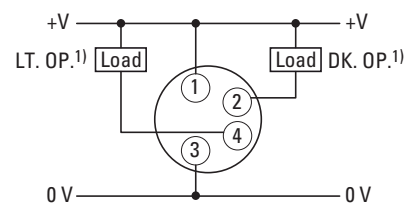

PNP

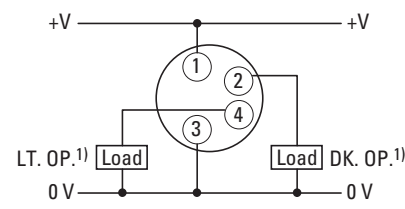

→ DIN IEC 304, DIN IEC 757

BK	Black
BN	Brown
BU	Blue
WH	white

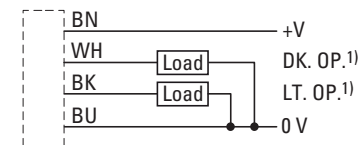
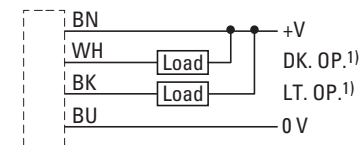

<sup>1)</sup>Bright output for diffuse sensors is BK/pin 4 and for retroreflective and thru-beam photoelectric sensors WH/pin 2.

## Dimensions

E71...

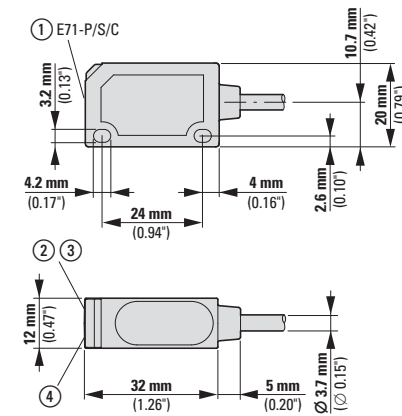

- ① Sensitivity potentiometer
- ② Stability LED
- ③ Power On LED
- ④ Output LED

## Technical data

	E71-T...	E71-N...	E71-P...	E71-S...	E71-F...	E71-C...
<b>General</b>						
Ambient temperature	°C					
Operation	θ	-25 - +55	-25 - +55	-25 - +55	-25 - +55	-25 - +55
Storage	θ	-25 - +70	-25 - +70	-25 - +70	-25 - +70	-25 - +70
Protection type		IP67	IP67	IP66	IP66	IP66
Mechanical shock resistance	g	30 Shock duration 11 ms	30 Shock duration 11 ms	30 Shock duration 11 ms	30 Shock duration 11 ms	30 Shock duration 11 ms
Vibration		Amplitude 0.5 mm: 10 - 55 Hz. IEC/EN 60068-2-6	Amplitude 0.5 mm: 10 - 55 Hz. IEC/EN 60068-2-6	Amplitude 0.5 mm: 10 - 55 Hz. IEC/EN 60068-2-6	Amplitude 0.5 mm: 10 - 55 Hz. IEC/EN 60068-2-6	Amplitude 0.5 mm: 10 - 55 Hz. IEC/EN 60068-2-6
<b>Characteristics</b>						
Bemessungsschaltabstand	$S_n$ mm	6000	1500	2500	350	100
Rated operational voltage	$U_e$	10 - 30 V DC	10 - 30 V DC	10 - 30 V DC	10 - 30 V DC	10 - 30 V DC
Maximum load current	$I_e$ mA	< 100	< 100	< 100	< 100	< 100
Switching Frequency	Hz	500	500	500	500	500
Response time	ms	1	1	1	1	1
Switching state display	LED	Yellow	Yellow	Yellow	Yellow	Yellow
Operating voltage display	LED	Green	Green	Green	Green	Green
Protective functions		Short-circuit protective device Protection against polarity reversal	Short-circuit protective device Protection against polarity reversal	Short-circuit protective device Protection against polarity reversal	Short-circuit protective device Protection against polarity reversal	Short-circuit protective device Protection against polarity reversal
Connection		4-wire	4-wire	4-wire	4-wire	4-wire
Bauform (äußere Abmessungen)	mm	Rectangular (20 x 12 x 32)	Rectangular (20 x 12 x 32)	Rectangular (20 x 12 x 32)	Rectangular (20 x 12 x 32)	Rectangular (20 x 12 x 32)
For connection of:						
...CA		2 m connection cable	2 m connection cable	2 m connection cable	2 m connection cable	2 m connection cable
...M8...		Plug-in connection M8 x 1	Plug-in connection M8 x 1	Plug-in connection M8 x 1	Plug-in connection M8 x 1	Plug-in connection M8 x 1
Material		Insulated material	Insulated material	Insulated material	Insulated material	Insulated material

**Description****Short Description**

The IntelliView™ Series from Eaton is a family of compact, high performance specialty photoelectric sensors designed to solve a wide array of sensing challenges.

IntelliView encompasses a variety of new sensing technologies: color, contrast and luminescence sensing; field-adjustable foreground and background suppression sensing; short-range distance sensing with analog outputs; and long-range, high-precision laser distance sensing with analog outputs.

To fit into your application, IntelliView sensors are available in industry-standard M18 flat-tubular and compact rectangular enclosure sizes. For ease of installation and replacement, all models are available with micro-connectors.

**Product Features**

- **New Sensing Technologies**—Eaton has developed high-accuracy sensing solutions designed to detect color, contrast, luminescence, and distance.
- **Small Size, Big Solutions**—IntelliView sensors come in either compact rectangular or flat-tubular enclosure sizes, both rugged sealed enclosures
- **Simple "learning mode" installation:** Most models feature a learning mode for quick and simple installation and setup.
- **Adjustable Background Suppression**—For the first time, Eaton offers a fully field-adjustable background suppression photoelectric sensor capable of detecting targets as far as 3.9 ft (1.9m) away.
- **LED Indicators and Pushbuttons**—Multiple LEDs communicate output and power status while built-in pushbuttons and adjustment potentiometers simplify the teaching of sensor settings.

**Approvals**

Adjustable Foreground/  
Background Suppression Models

- Ignores nuisance foreground or background objects.
- Field-adjustable sensing ranges.
- Compact 50x50 mm rectangular enclosure size.
- M12 micro-connector termination with 90- and 180-degree rotation options.
- Sensing ranges up to 47.2 in (120 cm).

**Foreground/Background Sensing Basic Information**

Foreground/background suppression sensors make it possible to set exact minimum and maximum detection distances. In other words, they can be used to ensure that targets will only be detected if they are exactly within the specified range. This prevents false positives caused by objects that are too close (foreground) or too far (background). This type of sensor is ideal for suppressing the detection of box edges and bottoms, sending an output only upon the presence of goods actually contained in the box.

Distance Sensing Models with  
Analog OutputsLong-Range, High-Precision Laser  
Distance Measurement Sensor

Short-Range Distance Sensor

- When within the effective range of the sensor, outputs a 0–10V signal proportional to the target's distance from the sensor face
- Class II laser emitter detects objects from 0.3 to 4m (1 to 13.1 ft) away.
- Two additional PNP outputs can be programmed to switch at predetermined ranges.
- Simple three-step learning mode for programming range limits.
- Unmatched accuracy and resolution at long sensing distances.
- Visible red LED emitter detects objects from 5 to 10 cm (1.9 to 3.9 in).
- Two indicator LEDs communicate sensor status: a yellow LED with light intensity proportional to the target's distance within the sensor's range, and a red LED that activates when the target is beyond maximum sensing range.
- Flat tubular enclosure can be mounted using the body threads or flat against a surface

**Distance Sensing Explained**

Distance sensors output a 0–10V analog signal in proportion to the measurement of the distance between the sensor and target. Optical triangulation, a technology similar to that used in Eaton's Perfect Prox or diffuse sensors, is used for short- to mid-range distance sensing applications that do not require a high degree of accuracy. For distance sensing applications that involve longer ranges, time-of-flight technology is used instead. 'Time-of-flight' is a method that measures the time it takes for the emitted beam to bounce off the target and return to the sensor. Time-of-flight is highly accurate, with precise resolution over long sensing distances.



## Color Sensors



- Can be programmed to recognize three different colors independently.
- Capable of sensing targets 5–45 mm away from the sensor face.
- Rectangular plastic enclosure features a four-digit display, two programming buttons and output status LEDs.
- Optional serial connection (RS485) allows for remote communications.
- Standard 8pole M12 micro connector.

### Color Sensing Basic Information

Color sensors work by using a chromaticity detection algorithm. Chromaticity is determined by two characteristics: hue and saturation. Hue is determined by the reflected light's wavelength, while saturation indicates the pureness percentage (with white representing 0%). Eaton's color sensor goes one step further and provides an optional "chromaticity plus intensity" algorithm. This operating mode provides a higher sensitivity to tone variations and is recommended for detection of different colors on the same type of material. It will also better distinguish between gray tones. The color of a target is determined by the color components of the reflected source light. The target color is identified by analyzing the red (R), green (G) and blue (B) channels of reflected light. For example, yellow can be identified by the following reflections: R=50%, G=50%, B=0% orange can be identified by R=75%, G=25%, B=0% pink by R=50%, G=0%, B=0% The RGB combinations are practically unlimited. Applications for color sensors are common in many industries, ranging from quality and process control, to automatic material handling for identification, to orientation and selection of objects according to their color.

## Contrast Sensors



- Ideal for detecting different colored or grayscale contrasts, such as registration marks
- Capable of sensing targets out to 10 mm from the sensor face
- Simple three-step setup routine for quick installation or optional "fine setup routine" for more complicated applications
- Complementary outputs can function in either light operate or dark operate modes.
- Standard M12 4pole micro-connector.

### Contrast Sensing Basic Information

Contrast sensors (also defined as color mark readers, according to their most popular application) go beyond simple presence/absence detection to distinguish two surfaces according to the contrast produced by their difference in reflectivity. For example, a dark reference mark (low reflectivity) can be detected by comparing it against the contrast of the lighter surface (high reflectivity). A white LED light source is used for general-purpose contrast detection. This makes it possible to detect the slightest contrast changes even when the reference material has the same composition and color. Contrast sensors are frequently used in automated packaging applications for registration mark detection to automate the folding, cutting and sorting phases.

## Luminescence Sensor







- Perfect for the detection of any luminescent target, even on reflective materials such as ceramics, metal or mirrored glass.
- Capable of sensing from 8–20 mm from the sensor face.
- Simple three-step setup routine. An advanced setup routine is also available for more complex applications.
- Can function in either light operate or dark operate mode.
- Standard M12 4pole micro-connector.

### Luminescence Sensing Basic Information

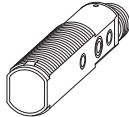
Luminescence is defined as visible light emission from fluorescent or phosphorescent substances. Luminescence sensors emit ultraviolet light, which is then reflected at a higher wavelength from the target surface. The UV emission from the sensor is modulated and the visible light received is synchronized, resulting in immunity against external interferences such as reflections caused by shiny objects. Luminescence sensors are used in various industries to detect labels, fluorescent marks or signs, fluorescent glues on paper, to distinguish cutting and sewing guides, and to check fluorescent paints or lubricants.

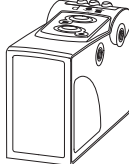
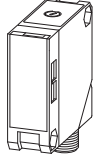
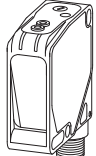
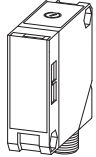
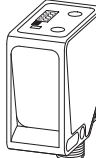
Ordering

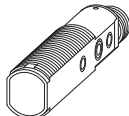
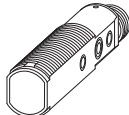
	Con- tion	Rated operational voltage	Switching principle	Rated switching distance S <sub>n</sub>	Switch- ing type	Type of light	Part no. Article no.	Price see price list	Std. pack
		U <sub>e</sub>		mm					
<b>E75-Serie IntelliView</b> Reflected-light beam Plug-in connection M12 x 1									
Distance sensor 5 - 10 cm Analog output 0 - 10 V 	4-wire	18 - 30 V DC	analog (0 - 10 V)	100	Analog	Infra- red	<b>E75-DST010A010-M12</b> 166995		1 off  
Distance sensor 30 - 400 cm 2 programmable PNP outputs 1 analog output 0 - 10 V 	5 conduct or	15 - 30 V DC	analog (0 - 10 V) Light switching	4000	PNP	Visible red	<b>E75-DST400A010-M12</b> 166996		
Background suppression (Perfect Prox) 	4-wire	10 - 30 V DC	Light/dark switching adjustable	100 250 500	PNP	Visible red Infra- red Infra- red	<b>E75-PPA010P-M12</b> 166998 <b>E75-PPA025P-M12</b> 166999 <b>E75-PPA050P-M12</b> 166924		
Background suppression (Perfect Prox) 	4-wire	10 - 30 V DC	Light/dark switching adjustable	1200	PNP	Infra- red	<b>E75-PP1MP-M12</b> 166997		
Fore-/background suppression (Perfect Prox) 	4-wire	10 - 30 V DC	Light/dark switching adjustable	1100	PNP	Infra- red	<b>E75-PPA110P-M12</b> 166925		
<b>E76-Serie IntelliView</b> Reflected-light beam Plug-in connection M12 x 1									
Color sensing 3 NO NPN outputs 3 NO PNP outputs 3 NO NPN outputs RS485-connection possible → Engineering 	8 conduct or	10 - 30 V DC	-	450	NPN PNP NPN	Infra- red	<b>E76-CLRMKN-M12</b> 166926 <b>E76-CLRMKP-M12</b> 166927 <b>E76-CLRMKRS-M12</b> 166928		1 off  
Contrast sensing 	4-wire	10 - 30 V DC	Light/dark switching adjustable	100 100	NPN PNP	Infra- red	<b>E76-CNT010N-M12</b> 166929 <b>E76-CNT010P-M12</b> 166892		
Luminescence sensing 	4-wire	10 - 30 V DC	Light/dark switching adjustable	200	PNP	Infra- red	<b>E76-UV020P-M12</b> 166830		

Engineering

Detection diagram E75-DST400A010-M12

Analog output

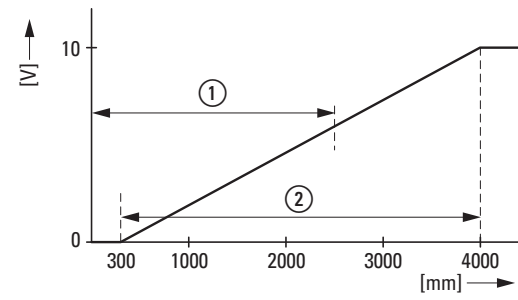

- ① Measuring distance
- ② Measurement range

Digital output

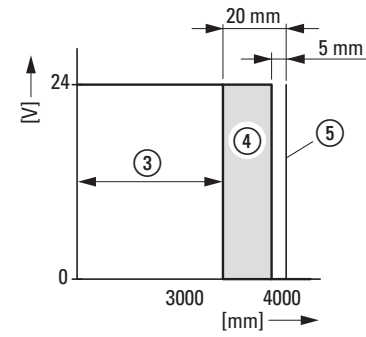

- ③ Switching distance
- ④ Hysteresis
- ⑤ Background

Black / white difference

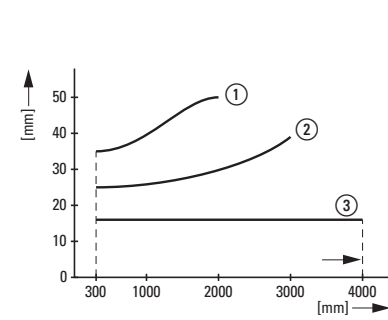

- ① White = 90 %, Black = 4 %
- ② White = 90 %, Grey = 18 %
- ③ White = 90 %

Detection diagram E75-DST010A010-M12

Analog output, proportional (default setting)

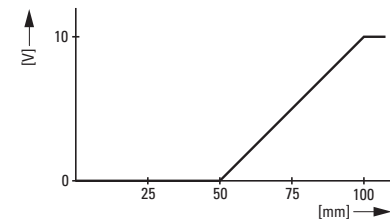

Analog output, proportionally inverted

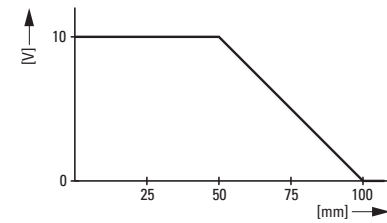

Detection diagram E76-CLR...

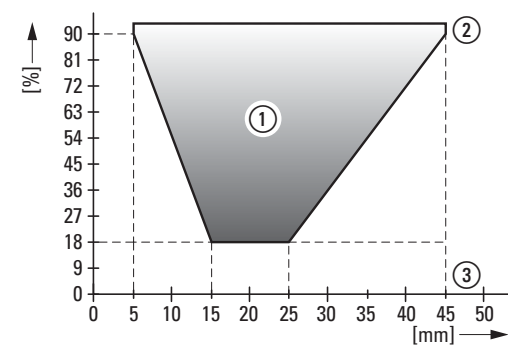

- ① Detectable Colors
- ② White/Light yellow
- ③ Dark blue/Black

Detection diagram E76-CN...

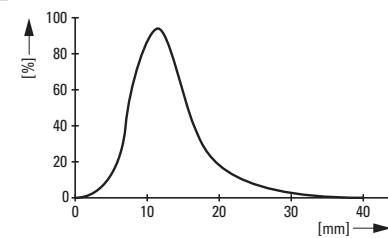
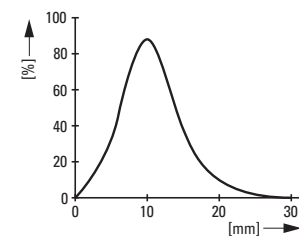

Circuit diagram E75-PPA.../E76PP1...

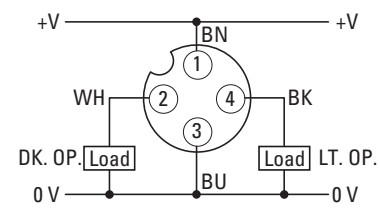

→ DIN IEC 304, DIN IEC 757

BN	Brown
BU	Blue
GN	Green
GY	Gray
PK	Pink
RD	Red
WH	white
YE	Yellow

Circuit diagram E75-DST010A010-M12

"Directly proportional" (DIR) is enabled when the white wire is connected to +V. "Indirectly proportional" is enabled when the white wire is connected to 0V. The white wire must be connected!

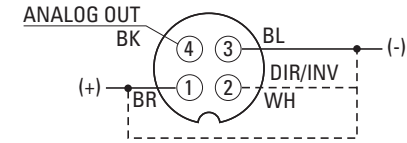

Circuit diagram E75-DST400A010-M12

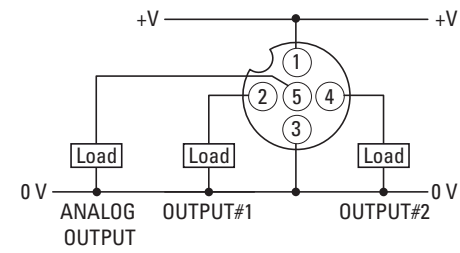

Circuit diagrams E76-CLR...

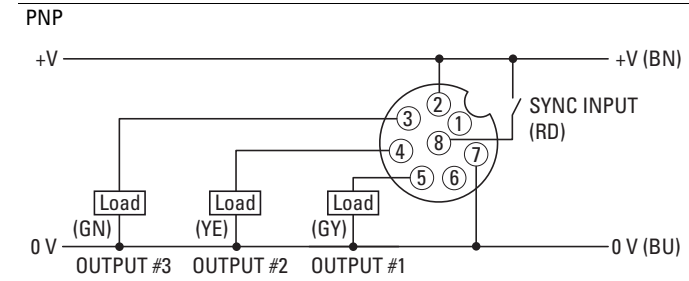
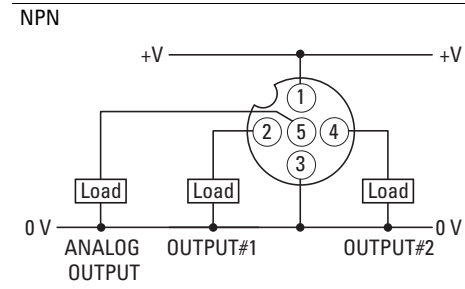

RS485

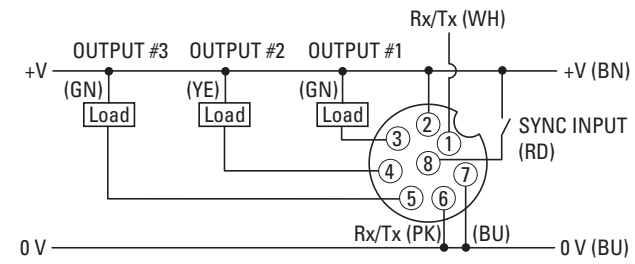

Circuit diagrams E76-CN...

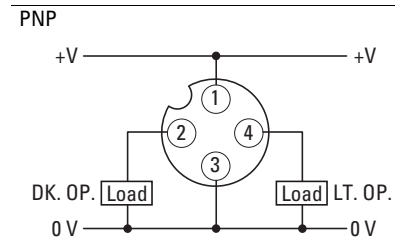
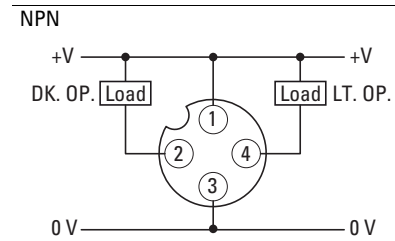

Circuit diagram E76-UV

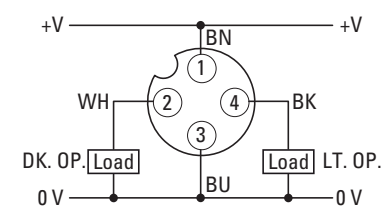

## Technical data

			E76-CLR...	E76-CNT...	E76-UV...
<b>General</b>					
Standards			IEC/EN 60947-5-2	IEC/EN 60947-5-2	IEC/EN 60947-5-2
Ambient temperature		°C			
Operation	θ	°C	-10 - +55	-10 - +55	-10 - +55
Storage	θ	°C	-20 - +70	-20 - +70	-10 - +70
Protection type			IP67	IP67	IP67
Mechanical shock resistance		g	30 Shock duration 11 ms	30 Shock duration 11 ms	30 Shock duration 11 ms
Vibration			Amplitude 0.5 mm: 10 - 55 Hz. IEC/EN 60068-2-6	Amplitude 0.5 mm: 10 - 55 Hz. IEC/EN 60068-2-6	Amplitude 0.5 mm: 10 - 55 Hz. IEC/EN 60068-2-6
<b>Characteristics</b>					
Rated switching distance	S <sub>n</sub>	mm	450	100	200
Rated operational voltage		U <sub>e</sub>	10 - 30 V DC	10 - 30 V DC	10 - 30 V DC
Maximum load current	I <sub>b</sub>	mA	-	< 100	< 100
Switching Frequency		Hz	770	2700	445
Response time		ms	0.65	0.19	1.1
Switching state display		LED	Yellow	Yellow	Yellow
Operating voltage display		LED	-	Green	Green
Protective functions			Short-circuit protective device	Short-circuit protective device	Short-circuit protective device
Connection			8 conductor	4-wire	4-wire
Design (outer dimensions)		mm	Rectangular (50 x 50 x 25)	M18 x 1	M18 x 1
For connection of:			Plug-in connection M12 x 1	Plug-in connection M12 x 1	Plug-in connection M12 x 1

			E75-DST0...	E75-DST4...	E75-PP1...	E75-PPA...
<b>General</b>						
Standards			IEC/EN 60947-5-2	IEC/EN 60947-5-2	IEC/EN 60947-5-2	IEC/EN 60947-5-2
Ambient temperature		°C				
Operation	θ	°C	-10 - +55	0 - +50	-25 - +55	-25 - +55
Storage	θ	°C	-20 - +70	-20 - +70	-25 - +70	-25 - +70
Protection type			IP67	IP67	IP67	IP65
Mechanical shock resistance		g	30 Shock duration 11 ms	30 Shock duration 11 ms	30 Shock duration 11 ms	30 Shock duration 11 ms
Vibration			Amplitude 0.5 mm: 10 - 55 Hz. IEC/EN 60068-2-6	Amplitude 0.5 mm: 10 - 55 Hz. IEC/EN 60068-2-6	Amplitude 0.5 mm: 10 - 55 Hz. IEC/EN 60068-2-6	Amplitude 0.5 mm: 10 - 55 Hz. IEC/EN 60068-2-6
<b>Characteristics</b>						
Rated switching distance		S <sub>n</sub> mm	100	4000	1200	
	... 010...		-	-	-	100
	... 025...		-	-	-	250
	... 050...		-	-	-	500
	... 110...		-	-	-	1100
Rated operational voltage		U <sub>e</sub>	18 - 30 V DC	15 - 30 V DC	10 - 30 V DC	10 - 30 V DC
Maximum load current		I <sub>b</sub> mA	-	< 100	< 100	< 100
Switching Frequency		Hz	68	42	500	500
Response time		ms	7.3	12	-	-
Switching state display		LED	Yellow	Yellow	Yellow	Red
Operating voltage display		LED	Green	Green	Green	Green
Protective functions			-	Short-circuit protective device	Short-circuit protective device	Short-circuit protective device
Connection			4-wire	5 conductor	4-wire	4-wire
Design (outer dimensions)		mm	M18 x 1	Rectangular (80 x 53 x 31)	Rectangular (50 x 50 x 18)	Rectangular (50 x 50 x 18)
For connection of:			Plug-in connection M12 x 1	Plug-in connection M12 x 1	Plug-in connection M12 x 1	Plug-in connection M12 x 1

Dimensions

E75...

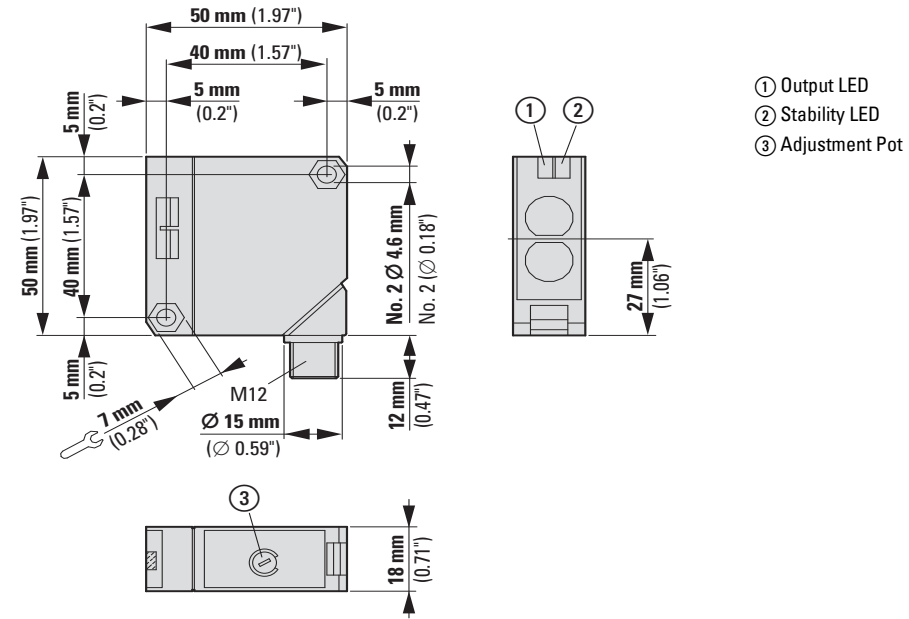

E76...

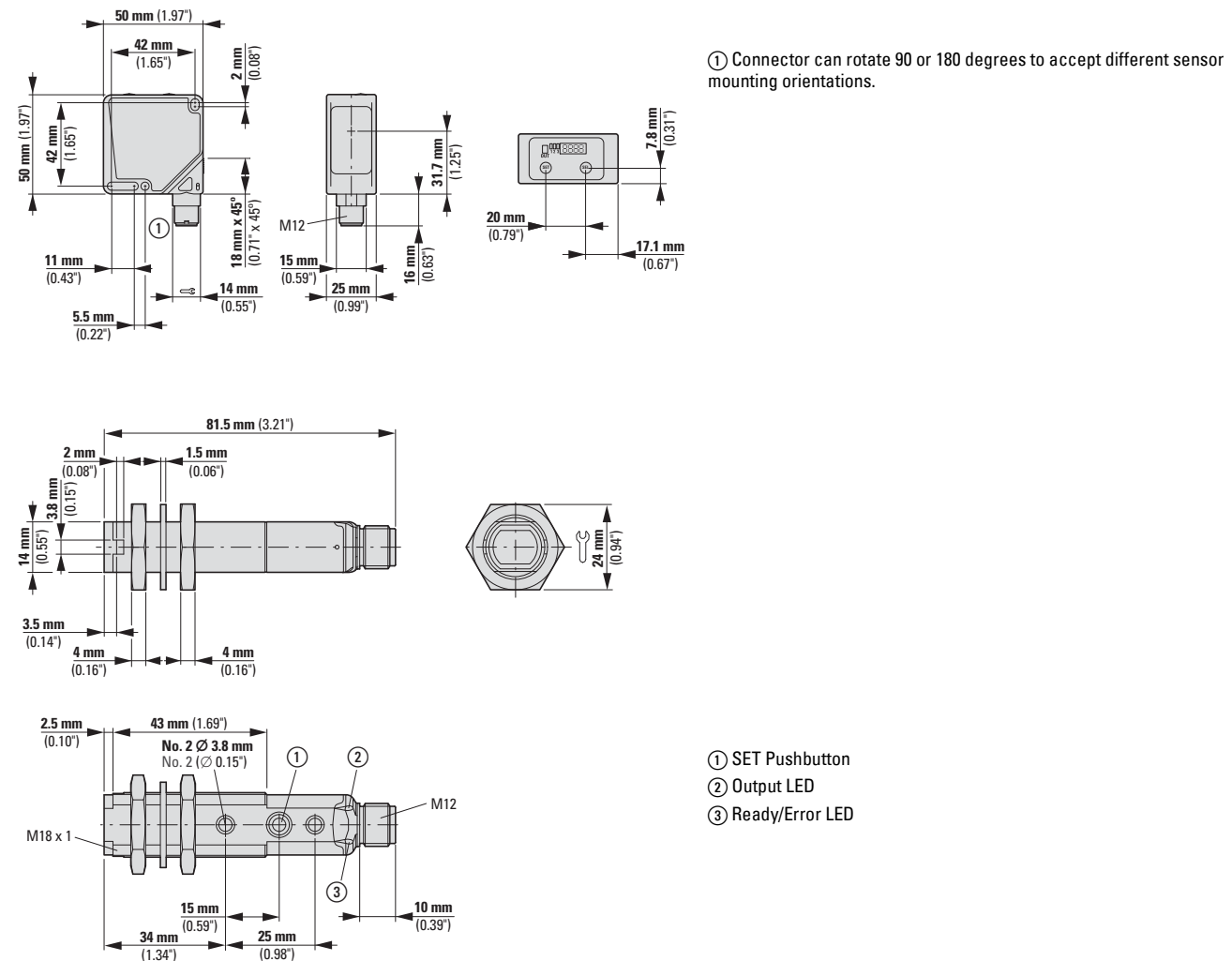

**Description**

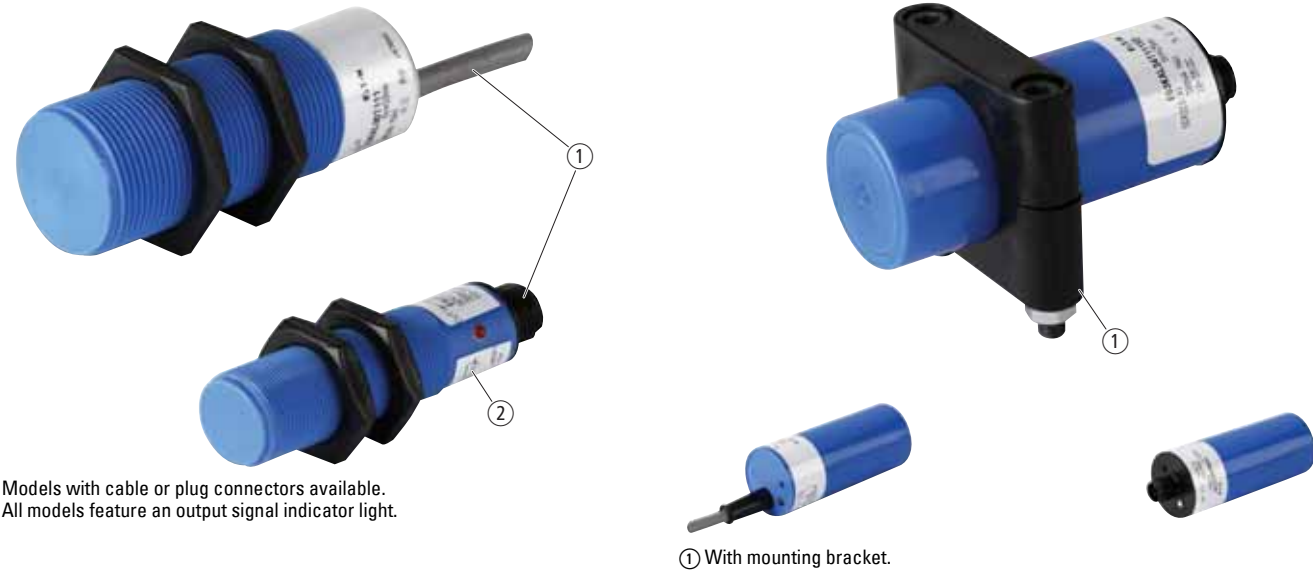

- ① Models with cable or plug connectors available.
- ② All models feature an output signal indicator light.

① With mounting bracket.

**Short Description**

Capacitive Proximity Sensors from Eaton's electrical business are self-contained devices designed to detect both metallic and nonmetallic targets. They are ideally suited for liquid level control and for sensing powdered or granulated material. For best operation, they should be used in an environment having relatively constant temperature and humidity.

**Product Features**



- Detect liquids, powders and other materials that are difficult or impossible with other sensor types.
- Corrosion-resistant insulated enclosure.
- Adjustable sensitivity.



**Approvals**







Ordering

	Rated operational voltage $U_e$	Rated switching distance $S_n$ mm	Type of mounting	Switching type	For connection of:	Contact configuration N/O = normally open contact N/C = normally closed contact	Material	Part no. Article no.	Price see price list	Std. pack
<b>E53</b>										
<b>2-wire</b>										
<b>M18 x 1</b>										
	20 - 250 V AC	8	Flush	-	2 m connection cable	1 N/O	Insulated material	<b>E53KAL18A2</b> 134517		1 off
				-	Plug-in connection M12 x 1	1 N/O		<b>E53KAL18A2SA</b> 134760		
				-	2 m connection cable	1 NC		<b>E53KBL18A2</b> 134791		
				-	Plug-in connection M12 x 1	1 NC		<b>E53KBL18A2SA</b> 134794		
		15	Non-flush	-	2 m connection cable	1 N/O		<b>E53KAL18A2E</b> 134518		
				-	Plug-in connection M12 x 1	1 N/O		<b>E53KAL18A2EA</b> 134519		
				-	2 m connection cable	1 NC		<b>E53KBL18A2E</b> 134792		
				-	Plug-in connection M12 x 1	1 NC		<b>E53KBL18A2EA</b> 134793		
<b>M30 x 1.5</b>										
	20 - 250 V AC	20	Flush	-	2 m connection cable	1 N/O	Insulated material	<b>E53KAL30A2</b> 134769		1 off
				-	Plug-in connection M12 x 1	1 N/O		<b>E53KAL30A2SA</b> 134772		
				-	2 m connection cable	1 NC		<b>E53KBL30A2</b> 134803		
				-	Plug-in connection M12 x 1	1 NC		<b>E53KBL30A2SA</b> 134806		
		25	Non-flush	-	2 m connection cable	1 N/O		<b>E53KAL30A2E</b> 134770		
				-	Plug-in connection M12 x 1	1 N/O		<b>E53KAL30A2EA</b> 134771		
				-	2 m connection cable	1 NC		<b>E53KBL30A2E</b> 134804		
				-	Plug-in connection M12 x 1	1 NC		<b>E53KBL30A2EA</b> 134805		
<b>3-wire</b>										
<b>M18 x 1</b>										
	10 - 30 V DC	8	Flush	NPN	2 m connection cable	1 N/O	Insulated material	<b>E53KAL18T110</b> 134761		1 off
					Plug-in connection M12 x 1	1 N/O		<b>E53KAL18T110SD</b> 134764		
					2 m connection cable	1 NC		<b>E53KBL18T110</b> 134795		
					Plug-in connection M12 x 1	1 NC		<b>E53KBL18T110SD</b> 134798		
				PNP	2 m connection cable	1 N/O		<b>E53KAL18T111</b> 134765		
					Plug-in connection M12 x 1	1 N/O		<b>E53KAL18T111SD</b> 134768		
					2 m connection cable	1 NC		<b>E53KBL18T111</b> 134799		
					Plug-in connection M12 x 1	1 NC		<b>E53KBL18T111SD</b> 134802		

	Rated operational voltage $U_a$	Rated switching distance $S_n$ mm	Type of mounting	Switching type	For connection of:	Contact configuration N/O = normally open contact N/C = normally closed contact	Material	Part no. Article no.	Price see price list	Std. pack						
<b>3-wire</b>																
<b>M18 x 1</b>																
	10 - 30 V DC	15	Non-flush	NPN	2 m connection cable	1 N/O	Insulated material	<b>E53KAL18T110E</b> 134762		1 off						
Plug-in connection M12 x 1					1 N/O	<b>E53KAL18T110ED</b> 134763										
2 m connection cable					1 NC	<b>E53KBL18T110E</b> 134796										
Plug-in connection M12 x 1					1 NC	<b>E53KBL18T110ED</b> 134797										
PNP					2 m connection cable	1 N/O		<b>E53KAL18T111E</b> 134766								
					Plug-in connection M12 x 1	1 N/O		<b>E53KAL18T111ED</b> 134767								
2 m connection cable				1 NC	<b>E53KBL18T111E</b> 134800											
Plug-in connection M12 x 1				1 NC	<b>E53KBL18T111ED</b> 134801											
<b>M30 x 1.5</b>																
				10 - 30 V DC	20	Flush		NPN			2 m connection cable	1 N/O	Insulated material	<b>E53KAL30T110</b> 134773		1 off
Plug-in connection M12 x 1											1 N/O	<b>E53KAL30T110SD</b> 134776				
2 m connection cable											1 NC	<b>E53KBL30T110</b> 134807				
Plug-in connection M12 x 1	1 NC	<b>E53KBL30T110SD</b> 134810														
PNP	2 m connection cable	1 N/O	<b>E53KAL30T111</b> 134777													
	Plug-in connection M12 x 1	1 N/O	<b>E53KAL30T111SD</b> 134780													
	2 m connection cable	1 NC	<b>E53KBL30T111</b> 134811													
	Plug-in connection M12 x 1	1 NC	<b>E53KBL30T111SD</b> 134814													
Non-flush	NPN	2 m connection cable	1 N/O				<b>E53KAL30T110E</b> 134774									
		Plug-in connection M12 x 1	1 N/O		<b>E53KAL30T110ED</b> 134775											
		2 m connection cable	1 NC		<b>E53KBL30T110E</b> 134808											
		Plug-in connection M12 x 1	1 NC		<b>E53KBL30T110ED</b> 134809											
	PNP	2 m connection cable	1 N/O		<b>E53KAL30T111E</b> 134778											
		Plug-in connection M12 x 1	1 N/O		<b>E53KAL30T111ED</b> 134779											
		2 m connection cable	1 NC		<b>E53KBL30T111E</b> 134812											
		Plug-in connection M12 x 1	1 NC		<b>E53KBL30T111ED</b> 134813											

Rated operational voltage $U_a$	Rated switching distance $S_n$ mm	Type of mounting	Switching type	For connection of:	Contact configuration N/O = normally open contact N/C = normally closed contact	Material	Part no. Article no.	Price see price list	Std. pack
<b>2-wire</b>									
34 									
20 - 250 V AC	35	Non-flush	-	2 m connection cable	1 N/O	Insulated material	<b>E53KAL34A2E</b> 134781		1 off
			-	Plug-in connection M12 x 1	1 N/O		<b>E53KAL34A2EA</b> 134782		
			-	2 m connection cable	1 NC		<b>E53KBL34A2E</b> 134815		
			-	Plug-in connection M12 x 1	1 NC		<b>E53KBL34A2EA</b> 134816		
<b>3-wire</b>									
34 									
10 - 30 V DC	25	Flush	NPN	2 m connection cable	1 N/O	Insulated material	<b>E53KAL34T110</b> 134783		1 off
				Plug-in connection M12 x 1	1 N/O		<b>E53KAL34T110SD</b> 134786		
				2 m connection cable	1 NC		<b>E53KBL34T110</b> 134817		
				Plug-in connection M12 x 1	1 NC		<b>E53KBL34T110SD</b> 134820		
			PNP	2 m connection cable	1 N/O		<b>E53KAL34T111</b> 134787		
				Plug-in connection M12 x 1	1 N/O		<b>E53KAL34T111SD</b> 134790		
				2 m connection cable	1 NC		<b>E53KBL34T111</b> 134821		
				Plug-in connection M12 x 1	1 NC		<b>E53KBL34T111SD</b> 134824		
	35	Non-flush	NPN	2 m connection cable	1 N/O	<b>E53KAL34T110E</b> 134784			
				Plug-in connection M12 x 1	1 N/O	<b>E53KAL34T110ED</b> 134785			
				2 m connection cable	1 NC	<b>E53KBL34T110E</b> 134818			
				Plug-in connection M12 x 1	1 NC	<b>E53KBL34T110ED</b> 134819			
			PNP	2 m connection cable	1 N/O	<b>E53KAL34T111E</b> 134788			
				Plug-in connection M12 x 1	1 N/O	<b>E53KAL34T111ED</b> 134789			
				2 m connection cable	1 NC	<b>E53KBL34T111E</b> 134822			
				Plug-in connection M12 x 1	1 NC	<b>E53KBL34T111ED</b> 134823			

Engineering

Circuit diagram

Rated operational voltage	Contact	2 m connection cable	Plug-in connection M12 (front view plug)
<b>2-Wire Sensors</b> 20–250 V AC	N/O and NC		
<b>3-Wire Sensors</b> 10–30 V DC	N/O (NPN)		
	N/O (PNP)		
	NC (NPN)		
	NC (PNP)		

Technical data

	E53...A...	E53...T...
<b>General</b>		
Standards	IEC/EN 60947-5-2-EMC	
Ambient temperature	- 25 - + 70 °C	- 25 - + 70
Protection type	IP65	IP65
Mechanical shock resistance	30 g Shock duration 11 ms	
<b>Characteristics</b>		
Repetition accuracy of $S_n$	10 %	10
Temperature drift of $S_n$	10 %	10
Switching hysteresis of $S_n$	20 %	20
Rated operational voltage	20 - 250 V AC	10 - 30 V DC
Residual ripple of $U_e$	10 %	10
Maximum load current	300 mA	300
Voltage drop at $I_e$	9 V	2
Switching Frequency	15 Hz	250
Min. load current	5 mA	-
Switching state display	LED	Red
Connection	2-wire	3-wire
Material	Insulated material	Insulated material

**Notes** Further technical data can be found in the Online Catalog at <http://de.ecat.moeller.net>

Dimensions

E53KAL18...  
E53KBL18...

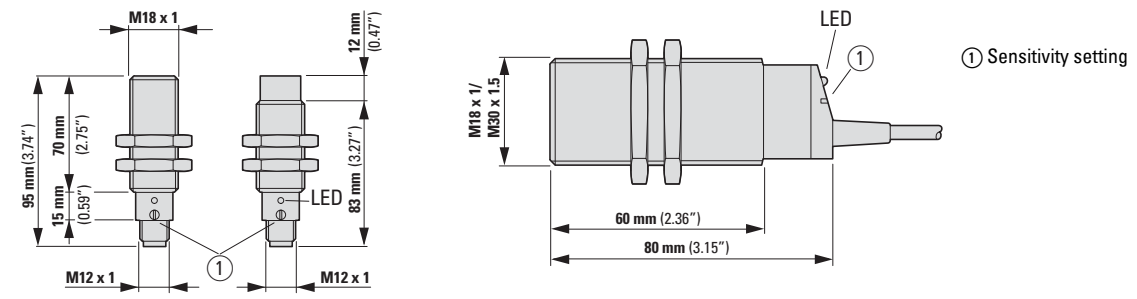

E53KAL30...  
E53KBL30...

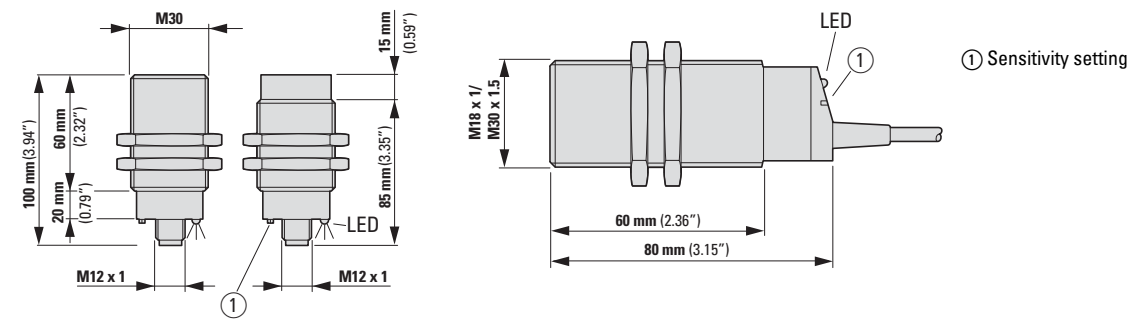

E53KAL34...  
E53KBL34...  
Plug-in connection M12 x 1

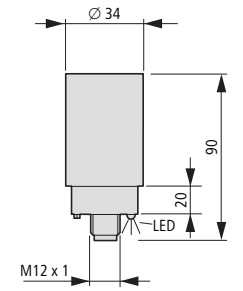

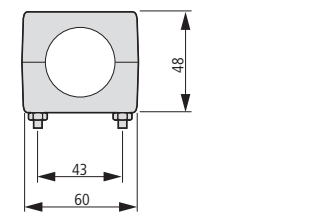

Fixing bracket included as standard



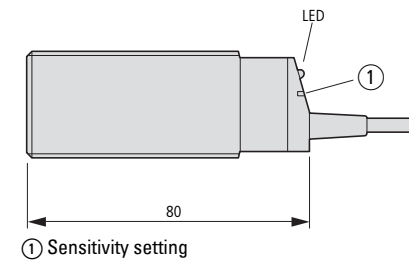



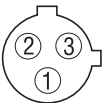
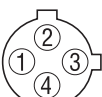
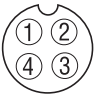
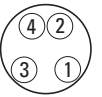
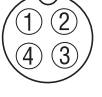

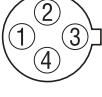

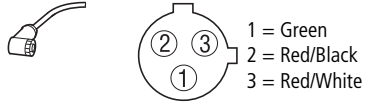
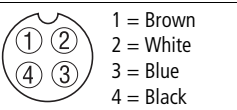
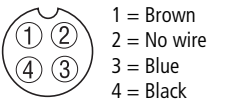
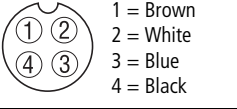
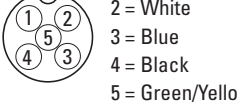
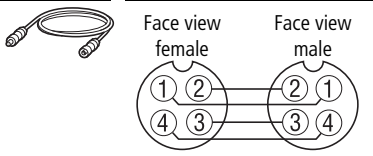
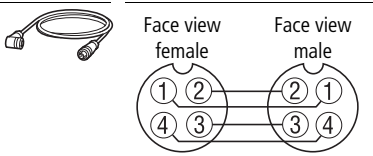
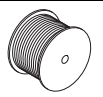

2 m connection cable

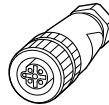

Ordering













Pin assignment	Description	Switching type	Voltage type	Pole	Length mm	For use with	Part no. Article no.	Price see price list	Std. pack
<b>Connecting cables</b>									
Open wire end Coupling, straight									
	1 = Green	-	-	AC	2000	AC sensors, 3 pole	<b>CSAS3F3CY2202</b> 136265		1 off
	2 = Red/Black	-	-		5000		<b>CSAS3F3CY2205</b> 136266		
	3 = Red/White	-	-		10000		<b>CSAS3F3CY2210</b> 136267		
	1 = Brown	-	-	AC	2000	AC sensors, 4 pole	<b>CSAS4A4CY2202</b> 136268		
	2 = Blue	-	-		5000		<b>CSAS4A4CY2205</b> 136269		
	3 = Black	-	-		10000		<b>CSAS4A4CY2210</b> 136312		
	1 = Brown	-	-	DC	2000	DC sensors, 4 pole, 2, 3 or 4-wire connection	<b>CSDS4A4CY2202</b> 136292		
	2 = White	-	-		5000	DC sensors, 4 pole, 2, 3 or 4-wire connection	<b>CSDS4A4CY2205</b> 136294		
	3 = Blue	-	-		10000	DC sensors, 4 pole, 2, 3 or 4-wire connection	<b>CSDS4A4CY2210</b> 136296		
	1 = Brown	-	-	DC	2000	DC sensors NanoView M8 4 pole 24AWG	<b>CSNS4A4CY2402</b> 100060		
	2 = White	-	-		5000	DC sensors NanoView M8 4 pole 24AWG	<b>CSNS4A4CY2405</b> 100065		
	3 = Blue	-	-		10000	DC sensors NanoView M8 4 pole 24AWG	<b>CSNS4A4CY2410</b> 100066		
	1 = Brown	-	-	DC	2000	DC sensors, 4 pole, 2 or 3-wire connection	<b>CSDS4A3CY2202</b> 136287		
	2 = No wire	-	-		5000		<b>CSDS4A3CY2205</b> 136288		
	3 = Blue	-	-		10000		<b>CSDS4A3CY2210</b> 136289		
	1 = Brown	-	-	DC	5000	DC sensors, IntelliView E75-DST4... 5 pole, M12	<b>CSDS5A5CY2205</b> 166986		
	2 = White	-	-		10000		<b>CSDS5A5CY2210</b> 166987		
	1 = Red/Black	-	-	DC	-	DC sensors, IntelliView E76-CLR... 8 pole, M12	<b>CSDS8A8CB2402</b> 100578		
	2 = Red/White	-	-		-		<b>CSDS8A8CB2410</b> 100580		
	3 = Red	-	-		-		<b>CSDS8A8CB2405</b> 100579		





Pin assignment	Des- cription	Switch- ing type	Voltage type	Pole	Length  mm	For use with	Part no. Article no.	Price see price list	Std. pack
<b>Open wire end Coupling, angled</b>									
	-	-	AC	3 pole	2000	AC sensors, 3 pole	<b>CSAR3F3CY2202</b> 136262		1 off
	-	-			5000		<b>CSAR3F3CY2205</b> 136263		
	-	-			10000		<b>CSAR3F3CY2210</b> 136264		
	-	-	DC	4 pole	2000	DC sensors, 4 pole, 2, 3 or 4-wire connection	<b>CSDR4A4CY2202</b> 136279		
	-	-			5000		<b>CSDR4A4CY2205</b> 136282		
	-	-			10000		<b>CSDR4A4CY2210</b> 136284		
	-	-	DC	4-pole, 3- conduc- tor	2000	DC sensors, 4 pole, 2 or 3-wire connection	<b>CSDR4A3CY2202</b> 136272		
	-	-			5000		<b>CSDR4A3CY2205</b> 136273		
	-	-			10000	DC sensors, 4 pole, 2 or 3-wire connection	<b>CSDR4A3CY2210</b> 136276		
	LED	NPN	DC	4-pole, 3- conduc- tor	5000	DC sensors, 4 pole, 2 or 3-wire connection	<b>CSDR4A3CY2205-LN</b> 136274		
	LED	PNP					<b>CSDR4A3CY2205-LP</b> 136275		
	-	-	DC	5 pole	2000	DC sensors, IntelliView E75-DST4... 5 pole, M12	<b>CSDR5A5CY2202</b> 166983		
	-	-			5000		<b>CSDR5A5CY2205</b> 166984		
	-	-			10000		<b>CSDR5A5CY2210</b> 166985		
<b>Plug, straight Coupling, straight</b>									
	-	-	DC	4 pole	1000	DC sensors, 4 pole, 2, 3 or 4-wire connection	<b>CSDS4A4CY2201-D</b> 136291		1 off
	-	-			1500		<b>CSDS4A4CY2201.5-D</b> 136316		
	-	-			3000		<b>CSDS4A4CY2203-D</b> 136293		
	-	-			5000		<b>CSDS4A4CY2205-D</b> 136295		
<b>Plug, angled Coupling, straight</b>									
	-	-	DC	4 pole	1000	DC sensors, 4 pole, 2, 3 or 4-wire connection	<b>CSDR4A4CY2201-D</b> 136278		1 off
	-	-			1500		<b>CSDR4A4CY2201.5-D</b> 136313		
	-	-			2000		<b>CSDR4A4CY2202-D</b> 136314		
	-	-			3000		<b>CSDR4A4CY2203-D</b> 136315		
	-	-			5000		<b>CSDR4A4CY2205-D</b> 136283		
<b>material sold by the meter</b>									
	-	-	AC, DC	3 pole	-	Plug, coupling M8 x 1	<b>CS3ACY24XX</b> 100033		1 off
	-	-		4 pole	-	Plug, coupling M12 x 1	<b>CS4ACY22XX</b> 100046		

	Description	Length mm	Switch- ing type	Pole	For use with	Material	Part no. Article no.	Price see price list	Std. pack
<b>Coupling</b>									
	angled	-	-	4 pole	DC sensors, 4 pole, 2, 3 or 4-wire connection	-	<b>CSDR4</b> 136271		1 off
		-	-		DC sensors, 4 pole, 2, 3 or 4-wire connection M8	-	<b>CSNR4</b> 100047		
	straight	-	-	3 pole	DC sensors, 3 pole, 2-, 3-wire connection M8	-	<b>CSNS3</b> 100054		
		-	-	4 pole	DC sensors, 4 pole, 2, 3 or 4-wire connection	-	<b>CSDS4</b> 136286		
		-	-			-	<b>CSNS4</b> 100055		
<b>Plug</b>									
	angled	-	-	4 pole	DC sensors, 4 pole, 2, 3 or 4-wire connection	-	<b>CSDRM4</b> 136285		1 off
		-	-		DC sensors, 4 pole, 2, 3 or 4-wire connection M8	-	<b>CSNRM4</b> 100053		
	straight	-	-	3 pole	DC sensors, 3 pole, 2-, 3-wire connection M8	-	<b>CSNSM3</b> 100067		
		-	-	4 pole	DC sensors, 4 pole, 2, 3 or 4-wire connection	-	<b>CSDSM4</b> 136297		
		-	-			-	<b>CSNSM4</b> 100068		
<b>M12 multi-connection block</b>									
	Cable	5000	NPN	4 pole (4 x M12)	DC sensors with PNP switching type	-	<b>CBDR4P05</b> 136301		1 off
		10000					<b>CBDR4P10</b> 136318		
	Terminal Block	-	NPN	4 pole (4 x M12)	DC sensors with NPN switching type	-	<b>CBDR4NSC</b> 136300		
		-					PNP	DC sensors with PNP switching type	
	Cable	5000	NPN	6 pole (6 x M12)	DC sensors with PNP switching type	-	<b>CBDR6P05</b> 136305		
		10000					<b>CBDR6P10</b> 136319		
	Terminal Block	-	NPN	6 pole (6 x M12)	DC sensors with NPN switching type	-	<b>CBDR6NSC</b> 136304		
		-					PNP	DC sensors with PNP switching type	
	Cable	5000	NPN	8 pole (8 x M12)	DC sensors with PNP switching type	-	<b>CBDR8P05</b> 136309		
		10000					PNP		
	Terminal Block	-	NPN	8 pole (8 x M12)	DC sensors with NPN switching type	-	<b>CBDR8NSC</b> 136321		
		-					PNP	DC sensors with PNP switching type	-
<b>Protection cap</b>									
	Plug-in connection M12 x 1	-	-	-	M12 (micro) multi-connector strip Plug	-	<b>CBMCAP</b> 136298		1 off
		-	-	-	M12 (micro) multi-connector strip Coupling	-	<b>CBCAP</b> 136317		
	Plug-in connection M12 x 1	-	-	-	M12 sensors, inductive	-	<b>E57KP12</b> 136202		
		-	-	-	M18 sensors, inductive	-	<b>E57KP18</b> 136203		
		-	-	-	M30 sensors, inductive	-	<b>E57KP30</b> 136204		



Description	Length mm	Switching type	Pole	For use with	Material	Part no. Article no.	Price see price list	Std. pack
<b>Conduit adapter</b>								
	Plug-in connection M12 x 1	-	-	M8 sensors	Metal	<b>E57KC8</b> 136187		1 off
		-	-	M12 sensors		<b>E57KC12</b> 136184		
		-	-	M18 sensors		<b>E57KC18</b> 136185		
		-	-	M30 sensors		<b>E57KC30</b> 136186		
		-	-	M30 sensors	Stainless steel	<b>E58KC30</b> 135754		

Design (outer dimensions) mm	For use with	Material	Part no. Article no.	Price see price list	Std. pack
<b>Fixing bracket</b>					
	-	M8 sensors	Stainless steel	<b>E57KM8</b> 136191	1 off
	-	M12 sensors		<b>E57KM12</b> 136188	
	-	M18 sensors		<b>E57KM18</b> 136189	
	-	M30 sensors		<b>E57KM30</b> 136190	
	38 x 38 x 44	M18 sensors	aluminum	<b>6161A-6501</b> 135736	2 off
	76 x 38			<b>6161AS5295</b> 135737	1 off
	38 x 38 x 44			<b>6161AS7050</b> 135741	
	69 x 76 x 64	M30 sensors	Metal	<b>6167A-6501</b> 135742	
	51 x 102 x 41 adjustable, insulated	M18 sensors	Stainless steel	<b>E58KAM18</b> 135749	
	51 x 102 x 41 adjustable, not insulated	M18 sensors		<b>E58KAM18U</b> 135751	
	51 x 102 x 50 adjustable, insulated	M30 sensors		<b>E58KAM30</b> 135752	
	51 x 102 x 50 adjustable, not insulated	M30 sensors		<b>E58KAM30U</b> 135753	
	38 x 38 x 44 with ball joint	M18 sensors	Insulated material	<b>E58KAM18B</b> 135750	
	-	E71 NanoView series	Metal	<b>E71-MTB1</b> 100520	
	-	E75-PPA...	Metal	<b>E75-MTB1</b> 100537	
	-	E76-CLR... E75-PP1MP-M12	Metal	<b>E76-MTB1</b> 100538	
	53 x 44	Comet series	Stainless steel	<b>6161AS5296</b> 135738	
	53 x 44	Comet series	Stainless steel	<b>6161AS5297</b> 135739	

Description	Design (outer dimensions) mm	For use with	Material	Part no. Article no.	Price see price list	Std. pack
<b>Replacement nuts</b>						
	-	-	M8 sensors	<b>E57KNM8</b> 136194		2 off
	-	-	M12 sensors	<b>E57KNM12</b> 136193		2 off
	-	-	M18 sensors	<b>E57KNC18</b> 136192		2 off
	-	-	M12 sensors	<b>E57KNS12</b> 136195		2 off
	-	-	M18 sensors	<b>E57KNS18</b> 136196		2 off
	-	-	M30 sensors	<b>E57KNS30</b> 136197		2 off
	-	-	M18 sensors E58-Serie	<b>E58KNS18</b> 135755		1 off
	-	-	M30 sensors E58-Serie	<b>E58KNS30</b> 135756		1 off
<b>Sensor fixing</b>						
	-	-	M8 sensors, inductive	<b>E57KNZ8</b> 136201		1 off
	-	-	M12 sensors, inductive	<b>E57KNZ12</b> 136198		
	-	-	M18 sensors, inductive	<b>E57KNZ18</b> 136199		
	-	-	M30 sensors, inductive	<b>E57KNZ30</b> 136200		
<b>Retro-reflector</b>						
<b>with polarisation filter</b>						
	Adhesive film	∅ 33 mm	Reflex photoelectric sensor	Insulated material	<b>6200A-6504</b> 135745	1 off
	Adhesive film	∅ 61 mm		<b>6200A-6505</b> 135746		
	Screw mounting	∅ 61 mm		<b>6200A-6502</b> 135744		
	Screw mounting	∅ 63 mm		<b>E65KR55</b> 135758		
	Screw mounting	∅ 84 mm		<b>6200A-6501</b> 135743	2 off	
	Screw mounting	∅ 84 mm		Plastic/metal	<b>6200A-6506</b> 135747	1 off
	Screw mounting	38 x 81 mm		Insulated material	<b>6200A-6507</b> 135748	1 off

Dimensions

Retro-reflector

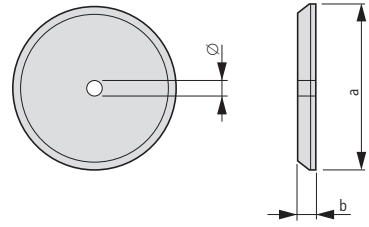

	a	b	∅
6200A-6501	3.30 (84)	0.35 (9)	0.20 (5)
6200A-6502	2.40 (61)	0.30 (7.5)	-
6200A-6504	1.30 (33)	0.25 (6)	-
6200A-6505	2.40 (61)	0.30 (7.5)	0.25 (6)
6200A-6506	3.30 (84)	0.30 (7.5)	0.20 (5)

E65KR55

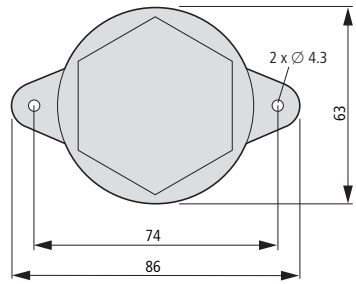

M12 multi-connection block

Cable

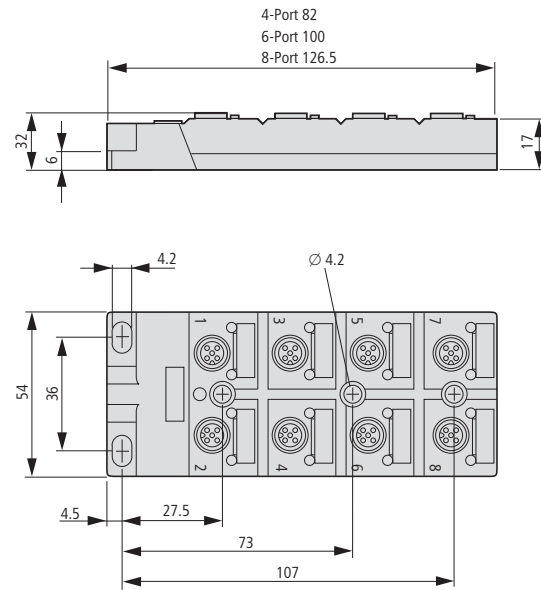

Terminal Block

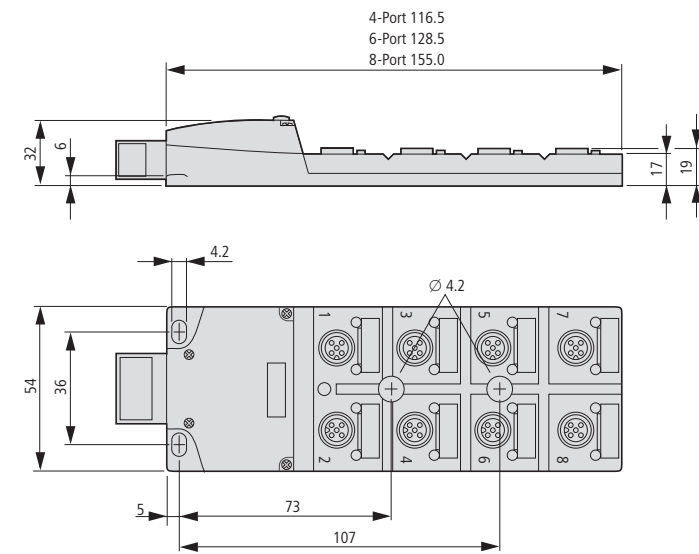

Fixing bracket

E58KAM18  
E58KAM18U

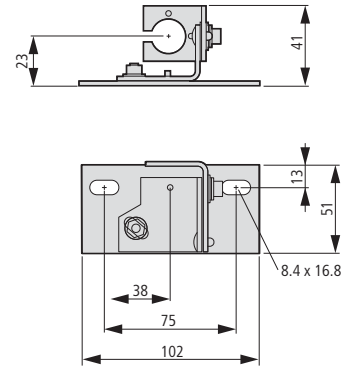

6161A-6501  
6161AS-6501

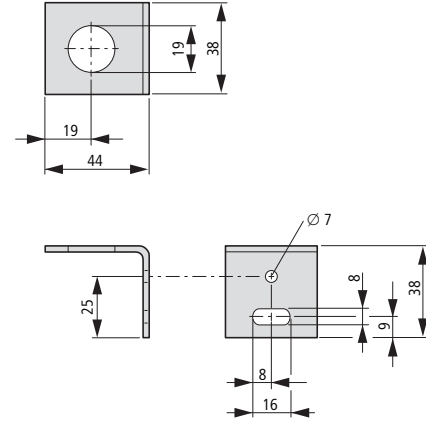

E58KAM30  
E58KAM30U

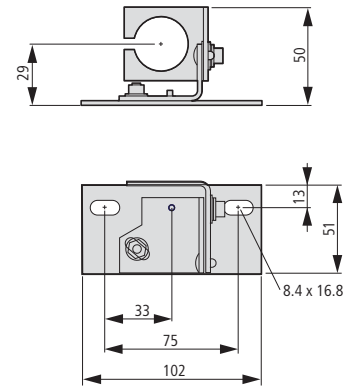

6167A-6501

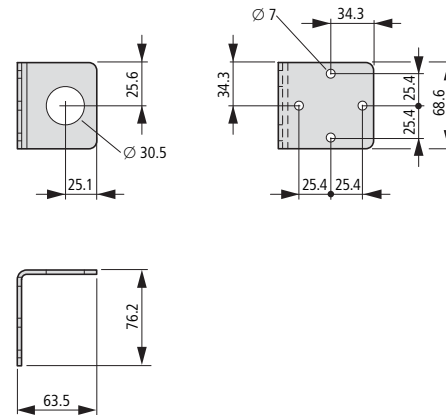

E58KAM18B

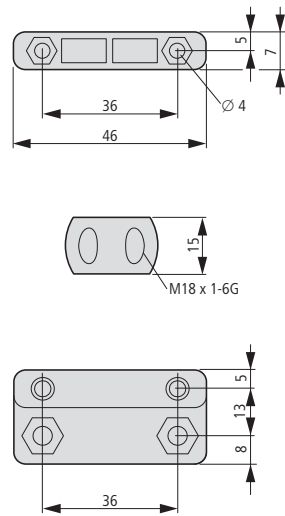

6161AS-7050

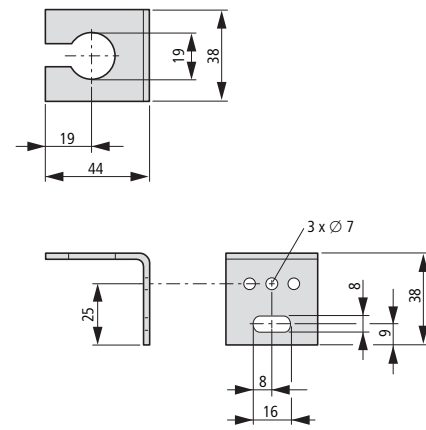

6161AS-5295

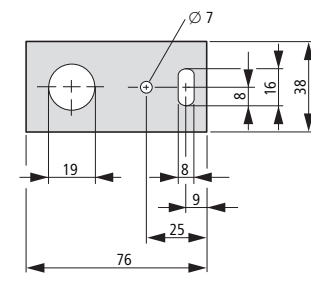

E57KM...

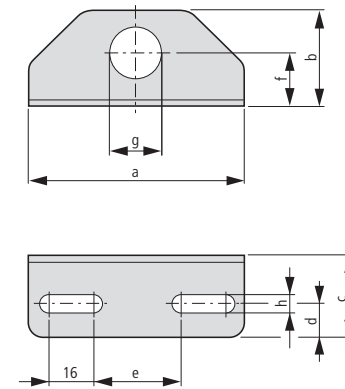

	a	b	c	d	e	f	g	h
8 mm	76	34	29	17	31	19	8	6
12 mm	76	34	29	17	31	19	12	6
18 mm	76	34	29	17	31	19	18	6
30 mm	108	55	45	25	51	29	30	7

Conduit adapter

E57KC...

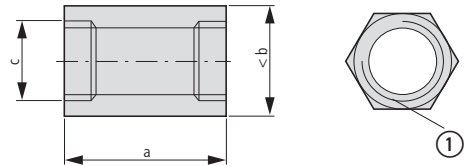

	a	b	c
8 mm	25	25	M8x1
12 mm	38	25	M12x1
18 mm	38	25	M18x1
30 mm	48	38	M30x1.5

① 1/2" - 14 NPT for conduit

E58KC30

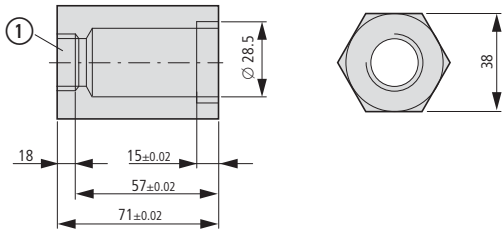

① 1/2" - 14 NPT for conduit

Sensor fixing

E57KNZ

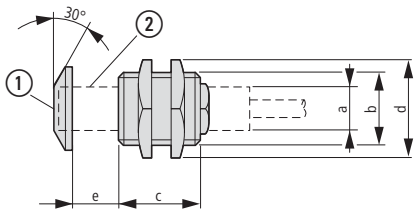

Sensor	a	b	c	d	e
8 mm	M8 x 1	M16x1.5	0.87 (22)	0.87 (22)	0.35 (9)
12 mm	M12x1	M22x1.5	0.87 (22)	1.12 (29)	0.41 (10)
18 mm	M18x1	M30x1.5	1.17 (30)	1.41 (36)	0.49 (12)
30 mm	M30x1.5	M47x1.5	1.47 (37)	1.72 (51)	0.57(15)

① Protection cap

② Overtravel

Connecting cables

Coupling straight, cable end open

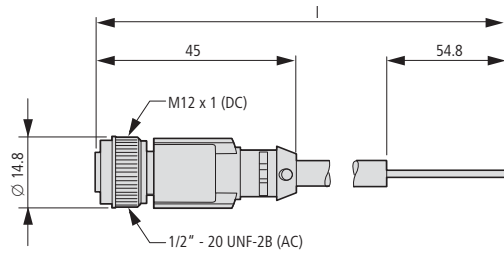

Coupling angled, cable end open

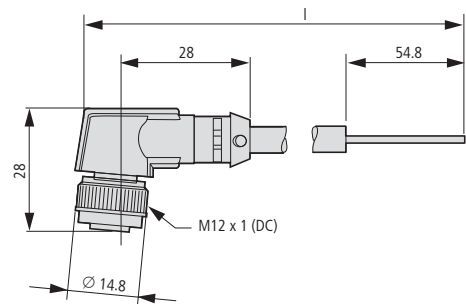

Straight coupling, straight plug

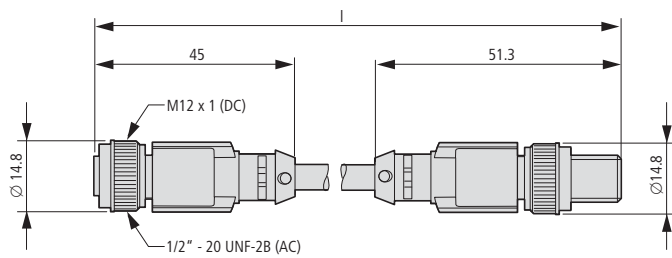

Coupling angled, angled

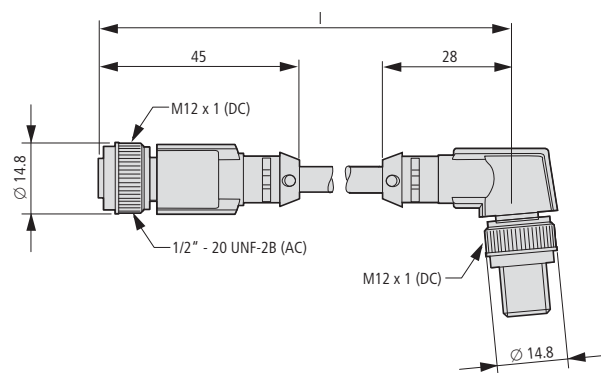

**Basic Information**

Sensors are devices that sense the presence or absence of objects. Sensors perform a number of functions in automated manufacturing and material handling systems. For example, sensors can determine if an object is present, if tooling is broken, or if product is running down a conveyor line.

A sensor can be thought of as an automatic switch. In a factory, a sensor can be used to detect a problem on the line and stop the line automatically.

Sensors have contributed significantly to recent advances in manufacturing technology. The use of sensors makes it possible to increase the degree of automation in processes and systems. In addition, it eliminates the need for human operators to monitor and control situations.

The two main categories of sensors are proximity sensors and light sensors.

**Proximity Sensors**



This type of sensor uses an electromagnetic or electrical field to detect when an object is near. There is no physical contact between the object and the sensor. Inductive proximity sensors detect only metal objects. Capacitive proximity sensors can sense both metallic and non-metallic objects.

Proximity sensors can be used, for example, to ensure that a part in a manufacturing process is aligned within a specific tolerance.

This type of sensor is generally used to sense at distances less than one inch (2.5 cm).

**Light sensors**



This type of sensor uses light to detect the presence or absence of an object.

**A thru-beam photoelectric sensor** uses two devices on opposite sides (a source and a detector).

Detection occurs when an object blocks or breaks the beam of light passing between them.

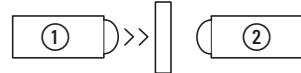
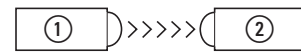

Light beam blocked: object detected

- ① Station
- ② Detectors

**A diffuse reflective sensor** (proximity sensing) emits a beam of light that must be reflected by the target object in order for the object to be detected.

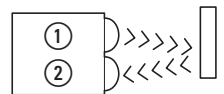
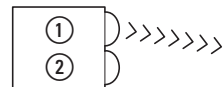

Reflected light beam: object detected

- ① Station
- ② Detectors

**A retroreflective sensing sensor** emits a beam of light that is reflected towards the sensor by a reflector. An object is detected when it blocks the beam of light between the sensor and the reflector. We will go over this type of light sensor in greater detail later on in this chapter.

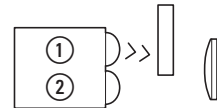
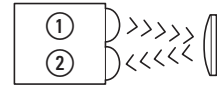

Light beam blocked: object detected

- ① Station
- ② Detectors

Most electric garage door openers include a light sensor for safety reasons. If the light sensor's beam of light is blocked (by a child, for example) while the door is being closed, the sensor will tell the door opener to reverse the direction of the door's movement or to stop the door.

Although environmental factors can affect light sensors, these devices have a long sensing range. The objects they detect can be of any material.

**Sensor Comparison**

Each of the two sensor categories has its strengths and weaknesses. The table below provides you with a comparison.

	<b>Proximity Sensors</b>	<b>Light sensors</b>
Method of Detection	Electromagnetic/electrical field	Light beam
Sensing Range	Close: within 2.5 cm (1 in)	Far: can be 800 ft (240 m)
Target Material	Inductive: metallic only Capacitive: metallic and non-metallic	Can be affected by target surface, for example, if the target is shiny or transparent
Object Markings	Not able to detect	Able to detect
Cost	Low	Low to high depending upon sensing method
Sensor Size	Small to large	Very small (fiber optic) to large
Environmental Sensitivity	Inductive: electrical interference Capacitive: humidity	Light interference
Response Time	Milliseconds	Microseconds

## Inductive Proximity Sensors

The inductive proximity sensor can be used to detect metal objects. It does this by creating an electromagnetic field.

With the ability to detect at close range, inductive proximity sensors are very useful for precision measurement and inspection applications.

### Strengths and Weaknesses

#### Strengths

- Immune to adverse environmental conditions.
- High switching frequencies for fast processes.
- Can detect metallic targets through non-metallic barriers
- Long operational life with virtually unlimited operating cycles.
- Bounceless switch outputs; e.g., to PLCs.

#### Weaknesses

- Limited sensing range (maximum of 25 mm, also up to 100 mm in E56 series).
- Detects only metal objects.
- May be affected by metal chips accumulating on sensor face.

### Scopes of application

Proximity sensors are used in a variety of applications. For example:

- Detecting the limit of a positioning table's travel
- Determining a speed by counting the teeth on a sprocket
- Checking whether a valve is fully open or closed

Proximity sensors can be used to detect the presence or absence of metallic workpieces or workpiece fixtures on conveyor belts.

Inductive sensors can be used to control robotic arms. They can be used, for example, to ensure that objects are actually gripped correctly.

In metal machining, proximity sensors can make sure the workpiece is mounted in the fixture correctly, and that the drill bit has not broken off.

### How an Inductive Proximity Sensor Works

Inductive proximity sensors generate a high-frequency (HF) electromagnetic field. When a metal object is brought near the sensor's face, the field changes. The detector circuit detects this change and the sensor switches an output to a connected device. Each sensor has a specific sensing range, which ensures that metallic objects will be detected with utmost precision in a repeatable manner.

### Surface mounting

Let's look at the components and the process step-by-step:

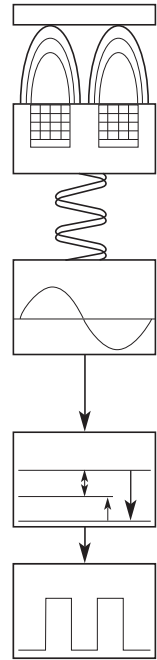

#### Components

A metal object, or target, enters the sensing field.

The **sensor coil** is a coil of wire typically wound around a ferrite core. If you could see the electromagnetic field created by it, it would be cone shaped. The target will pass through this field.

The ferrite core shapes the field and the size of the coil determines the sensing range.

The **oscillator circuit** makes the field oscillate at a specific high frequency (100 kHz to 1 MHz). The presence of metal in the field causes this vibration to change. Eddy currents, which take energy from the field, are induced on the target object. Accordingly, the metallic object causes a change in the magnetic field. This change creates a damping effect on the amount of signal that cycles back to the sensor coil. The amplitude is reduced accordingly.

The **detector circuit** detects this change and switches at a specific setpoint value. This signal, in turn, produces a change at the switching output.

The output remains active until the target leaves the sensing field. The oscillator responds with an increase in amplitude, and when it reaches the setpoint value, the detector circuit switches. The output returns to its normal state.

### Hysteresis

Hysteresis is a fixed distance between the ON and OFF points. If hysteresis were not included in a sensor's design, the output would continuously switch on and off when close to the operating point.

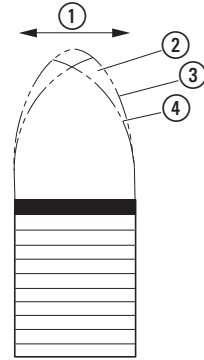

#### Hysteresis

- ① Direction of movement
- ② Hysteresis
- ③ operate point
- ④ release point

With hysteresis, the operate point and the release point are slightly different distances from the sensor face.

### Proximity Sensor Types

Proximity sensors come in a wide variety of designs to meet the requirements of almost any industrial application.

- Tubular



This is the design of choice for a growing number of applications. The small size allows for easy mounting in a fixture or for use in tight spaces found on many assembly lines.

- Right angle tubular



This design enables mounting in tight locations.

- Plastic housing



This corrosion-resistant unit performs well in high wash-down areas or places where caustic chemicals abound.

- Pancake



The extra-large coil in this unit makes it possible to achieve the widest and tallest available sensing range of 100 mm. It is ideal for use in heavy industry applications and for the assembly of large components.

## Basic information

### Inductive Proximity Sensor Influences

When applying inductive proximity sensors, it is important to understand the sensing range and the factors that influence that range. The sensing range refers to the distance between the sensor face and the target.

Four considerations are of particular importance when selecting and using proximity sensors:

- Target considerations (material, size, shape and approach)
- Coil size and screening
- Sensor mounting requirements
- Environment

### Target Material

The target object's material will affect the maximum sensing range. If this maximum distance is exceeded, the damping effect needed to switch the sensor output will not be produced and the sensor will not detect the target object.

Proximity sensors work best with ferrous alloys. Though these sensors detect other metals, the range will not be as great. Generally, the less iron in the target, the closer the target has to be to the sensor to be detected.

Manufacturers generally provide charts showing the necessary correction factors for various types of metals when applying their sensors. Each sensor style will have a correction factor to enable calculation for a particular target material.

### Target Size

If the target object is smaller than the sensor's "standard target size," the sensing range will also be smaller. This is because a smaller target creates a weaker eddy current. However, a bigger target does not mean a longer sensing range.

The thickness of the target does not impact sensing range much. However, a very thin non-ferrous target can actually achieve a greater sensing range because it generates an eddy current on both sides.

So, how big should the target be? The rule of thumb is: the size of the sensor's diameter, or three times the sensor's sensing range, whichever is greater.

### Target Shape

The shape of the target can have an impact on the sensing range. A round object, or an object with a rough surface can affect the damping effect of the sensor, and may require a closer sensing distance. Using a larger sensor size or an extended range sensor will also minimize this effect.

### Target Approach

How the target approaches the sensor matters as well. When an object comes at the sensor straight on, that's an **axial approach**. With this type of approach, you will need to protect the sensor physically. Allow for 25% over-travel.

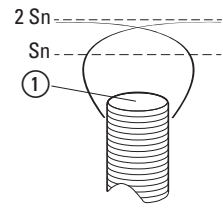

Axial Approach  
① sensing face

Hysteresis tends to be greater for an axial approach than a lateral approach.

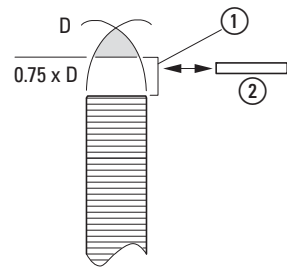

Lateral Approach  
① recommended detection range  
② Target

On a slide-by, or **lateral approach**, the target approaches the center axis of the sensing field from the side (lateral).

The target should not pass closer than the basic tolerance built into the machine design.

For both approach types, it is necessary to ensure that the distance between the target object and the sensor face does not exceed 75% of the sensing range.

**Coil/Core Size**

An important factor in the range of the sensor is the construction of the coil/core. An open coil with no core will produce a field that could be actuated by a target from any direction. That wouldn't be recommended for industrial applications.

For an inductive proximity sensor, the sensor coil that generates the field fits inside of a ferrite core. This cup-shaped piece of ferrite material is called a **cup core**. This core directs the field and shapes it.

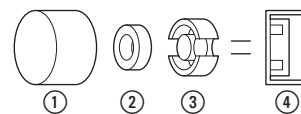

Coil/Core Construction  
① Protection cap  
② Coil  
③ Cup core  
④ Sensor head

A protective **cap** prevents dust or other environmental hazards from entering the sensor.

**Screening**

The coil can be screened in order to focus the field strength. In standard range sensors, the ferrite cup core will shape the field in such a way that it is emitted straight forward from the sensor's sensing face - i.e., "screened"

in a manner of speaking.

An extended-range coil/core assembly does not use the standard cup core, but rather just a ferrite core. This unshielded sensor makes it possible to expand the sensing range. The reason why is that there is less ferrite to absorb the electromagnetic field. Accordingly, the sensor's effective range will become wider and a little longer.

The decision to use an unshielded sensor will impact the mounting of the sensor, as we will discuss that next.

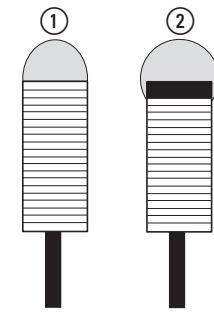

Screening  
① flush mounting (screened)  
② non-flush mounting (unscreened)

**Mounting Considerations**

A flush-mounted screened sensor can be fully embedded in a metal mounting block without affecting the sensor's sensing range.

In contrast, an unshielded sensor will require a certain distance (metal-free zone) around it - this distance will depend on the sensor's sensing range. Otherwise, the sensor will sense the metal fixing and be continuously operating.

Accordingly, a sensor's design (screening) will affect the way it is mounted.

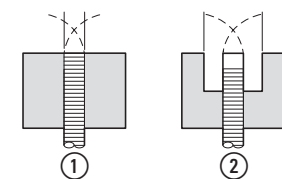

Clear Zone  
① flush mounting (screened)  
② non-flush mounting (unscreened)

Mounting two sensors closely together can also be a problem. If you position two proximity sensors too close together—either side by side or facing each other head-to-head—the two fields will clash with one another. Each sensor needs to be mounted at least three times its own sensing range away from the other. The use of an alternative frequency head on one of the sensors will prevent adjacent sensors' sensing fields from interacting.

**Environment**

The sensor's environment can affect its performance dramatically. Some of these environmental factors are:

- Debris  
Debris can accumulate on the sensing cap, changing the range of the sensing field. In an application where

metal chips are created, the sensor should be mounted to prevent those chips from building up on the sensor face. If this is not possible, then coolant fluid should be used to wash the chips off the face. An individual chip generally doesn't have enough surface area to cause the sensor to turn on, but several of them could extend the sensing range and interfere with the accuracy of the sensor.

- Electrical cables  
Magnetic fields caused by electrical wiring located in the vicinity may affect sensor operation. If the field around the wires reaches an intensity that would saturate the ferrite or the coil, the sensor will not operate. Sensors used in areas with high frequency welders can also be affected. To compensate for a welder, weld field immune sensors can be installed. Or, if the sensor is used with a PLC, a time delay can be programmed to ignore the signal from the sensor for the time period that the welder is operating.

- High frequency source (HF)  
RF sources (such as walkie-talkies) can produce signals that use the same frequency as the sensor's oscillator circuit. This is called radio frequency interference (RFI). Sensors have integrated EMC protection components in order to provide maximum protection against radio frequency interference and sensor malfunctions.

Electrical interference from nearby motors, solenoids, relays and the like could have an affect on sensor operation as well.

- Induced line or current spike  
An induced line or current spike can cause a false operation of the sensor. This spike can be produced by the electrical arc created when an electrical/mechanical switch or a contactor closes. If the lines connecting the sensor and these devices are adjacent and parallel to one another, the spike will affect the sensor. Most codes and specifications call for a separation of control and power leads.

- Ambient air temperature  
The ambient temperature can affect sensing range. The effect is referred to as temperature drift. The sensing range can change by as much as ±10%.

Component variations, power-line noise, ambient air temperature, and the effects of normal machine wear can all contribute to changes in sensing ranges. Because of this, sensors must be selected in such a way that they will detect target objects at 75% of the nominal switching distance and will be deactivated at 125%.

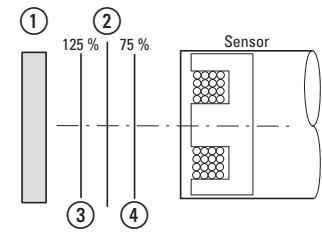

Sensing Distance Tolerances  
① Target  
② Nominal sensing range  
③ Maximum reset distance  
④ Maximum real operating range



## Capacitive Proximity Sensors

Capacitive proximity sensors basically have the same function as inductive proximity sensors, but their detection method is considerably different.



### Capacitive Proximity Sensors

Capacitive proximity sensors are designed to detect both metallic and nonmetallic targets. They are ideally suited for liquid level control and for sensing powdered or granulated material.

### Strengths and Weaknesses

Consider these strengths and weaknesses of the capacitive proximity sensor:

#### Strengths

- Can detect both metallic and non-metallic objects at greater ranges than inductive sensors.
- High switching rate for rapid response applications (counting).
- Can detect liquid targets through non-metallic barriers (glass, plastic).
- Long operation life, solid-state output for “bounce free” signals

#### Weaknesses

- Affected by varying temperature, humidity and moisture
- Not as accurate as inductive proximity sensors

### Scopes of application

Here are some examples showing how the detection power of capacitive proximity sensors is used:

- Detecting liquid levels in order to prevent overflowing and dry-running is a frequent application in the packaging industry.
- Checking material quantities in order to make sure, for example, that the label roll on a labeling line is not completely used up.
- Counting applications, such as tracking units passing a point on a conveyor.
- Injection molding machines: detecting the fill level of the plastic granules in the feed hopper.

### Capacitive Proximity Sensor Operation

A capacitor consists of two metal plates separated by an insulator (called a **dielectric**). The function of this type of sensor is based on dielectric capacitance, which is the ability of a dielectric to store an electrical charge.

The distance between the plates determines the ability of the capacitor to store a charge.

The capacitance value changes when an object enters the electric field. This change is evaluated for the switching

function.

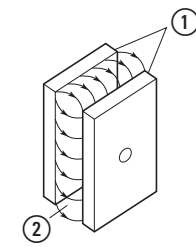

Capacitor

- ① Plates
- ② Dielectric

When this principle is applied to the capacitive proximity sensor, one capacitive plate is part of the switch, the enclosure (the sensor face) is the insulator. The target is the other “plate.” Earth is the common path.

Capacitive proximity sensors can detect any target that has a dielectric constant greater than air. Liquids have high dielectric constants. Metal also makes a good target.

The capacitive proximity sensor has four basic elements: a sensor (which is a dielectric), an oscillator circuit, a detector circuit and an output circuit.

When an object approaches the sensor, the capacitor’s permittivity changes and the vibration in the oscillator circuit starts. This means that capacitive sensors work exactly the opposite way as inductive proximity sensors, in which the vibration is damped when a target object approaches.

### Oscillator Damping

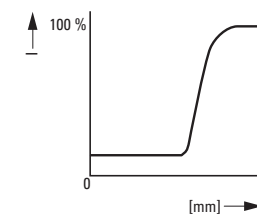

Inductive

I = Current in oscillator circuit

The **detector circuit** monitors the oscillator’s output. When it detects sufficient change in the field, it switches on the output circuit.

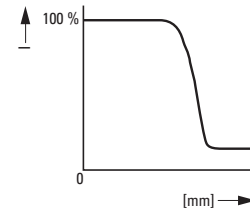

Capacitive

I = Current in oscillator circuit

The output circuit remains active until the target leaves the sensing field. The oscillator then responds by reducing the amplitude. The detector circuit is switched off if the change in the electric field becomes too small.

The internally fixed difference between the vibration’s ON and OFF amplitudes forms the hysteresis.

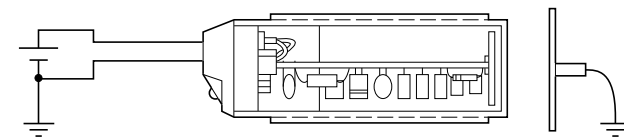

Capacitive Proximity Sensor Operation

### Capacitive Proximity Sensor Influences

Typically, capacitive sensors have a greater sensing range than inductive sensors.

Sensing distance for capacitive proximity sensors is dependent on plate diameter. With inductive proximity sensors, the size of the coil is the determining factor.

### Typical Proximity Sensing Ranges

non-flush sensor with Ø	Inductive e	Capacitive e
18 mm	8 mm	15 mm
30 mm	15 mm	25 mm
34 mm	-	35 mm

### Sensitivity Adjustment

Most capacitive proximity sensors are equipped with sensitivity adjustment potentiometers. In inductive sensors, the coil size is the decisive factor. Since the sensor measures a dielectric gap, the sensing range needs to be adjusted in line with the various relevant ambient conditions.

### Target Material and Size

A capacitive sensor should not be hand-held during set up. Because your hand has a dielectric constant greater than air, the sensor may detect your hand rather than the intended target.

Capacitive sensors can detect both ferrous and non-ferrous materials equally well. There is no derating factor to be applied when sensing metal targets. But, other materials do affect the sensing range.

Because they can be used to detect liquid through a nonmetallic material such as glass or plastic, you need to ensure that the sensor detects just the liquid, not the container. The transparency of the container has no effect on the sensing.

For all practical purposes, the target size can be determined in the same

## Basic information

manner as was discussed in “Target Size” on Page page 104 for inductive proximity sensors.

### Environment

Many of the same factors that affect inductive proximity sensors, also affect capacitive sensors, only more so.

- Embeddable mounting—capacitive sensors are generally treated as unscreened devices, and therefore, are not embeddable.
- Deposits / chips: They are more sensitive to metallic and nonmetallic chips and residue.
- Adjacent sensors—more space between devices is required due to the greater, unscreened sensing range
- Target background—because of both the greater sensing range, and its ability to sense metallic and non-metallic materials, greater care in applying these sensors is needed when background conditions are present
- Ambient atmosphere—the amount of humidity in the air may cause a capacitive sensor to operate even when no target is present
- Welding magnetic fields—capacitive sensors are generally not applied in a welding environment
- Radio Frequency Interference (RFI)—in the same way that inductive proximity sensors are affected, RFI interferes with capacitive sensor circuitry

**Light sensors**

Light sensors can be used in a wide variety of applications. They can detect objects more quickly and at longer distances than many competing technologies. This is why light sensors have quickly become one of the most frequently used automatic detection methods in manufacturing.



**Scopes of application**

- Some of the common uses for light sensors include:
- **Material handling:** A sensor can ensure that products move along a conveyor belt in an orderly manner. The sensor will stop the operation if a jam occurs. In addition, individual objects can be counted as they move down the flat conductor.
  - **Packaging:** Sensors can check whether containers have been filled, labeled, and sealed correctly.

- **Machine operation:** Sensors can monitor a machine's proper operation and ensure that the required materials are present and that tools are in good condition.
- **Paper Industry:** Sensors can detect web flaws, web splice, clear web and paper presence, while maintaining high web speeds.

**Design Flexibility**

Light sensors are available in a wide variety of designs. Sources and detectors can be arranged in a multitude of manners in order to meet the requirements of the application in question.

**Operating modes**

We will briefly introduce you to these modes, and fully explain them later (→ Page 107).

Operating mode	Description	Operating mode	Description
<b>Thru-beam photoelectric sensors</b> 	<p>A source unit in one location sends a light beam to a detector unit in another location. An object is detected when it passes between the source unit and the detector unit, interrupting the light beam.</p>	<b>Diffuse reflective sensor</b> 	<p>The light source and the detector are located in a single housing. If a target object moves in front of the optical sensor, it will directly reflect the beam of light back to the detector.</p>
<b>Polarized retroreflective arrangement</b> 	<p>The light source and the detector are located in a single housing. The emitted beam of light is mirrored by the polarizing reflector with a phase offset of 90°. The target object blocks the polarized beam of light.</p>	<b>Background suppression (Perfect Prox)</b> 	<p>This is a special type of diffuse reflective sensor that consists of two detectors. This sensor offers reliable detection of target objects in a defined sensing range and at the same time ignores objects outside of this range.</p>

**Basic Operation of Light Sensors**

The operation of the light sensor is quite simple. A source light-emitting diode (LED) sends a beam of light, which is picked up by a photodetector.

When an object moves into the path of the light beam, the object is detected. Let's look at how a light sensor works.

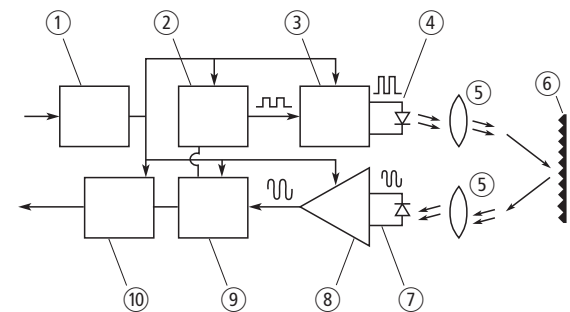

- ① Power supply
- ② Modulator: generates pulses to cycle amplifier and LED at desired frequency.
- ③ Amplifier
- ④ LED
- ⑤ Lens
- ⑥ Target object or reflector
- ⑦ ⑧ Detector: Either a photodiode or a photo-transistor device, selected for a

- maximum sensitivity at the source LED's emitted light wave-length. Both the source LED and the detector have protective lenses. When the detector picks up the light, it sends a small amount of current to the detector amplifier.
- ⑧ Detector Amplifier: Blocks current generated by the background light. It also provides amplification of the signal received to a usable level, and

- sends it through to the demodulator.
- ⑨ Demodulator: Sorts out the light thrown out by the detector from all other light in the area. If the demodulator decides the signals it receives are okay, it signals the output.
- ⑩ Output: Performs switching routine when directed to do so by the demodulator.

The Light Source

Today's light sensors use a light-emitting diode (LED) to produce their beam of light. Using LEDs offers many significant advantages:

- A LED can be rapidly switched and instantly turned ON and OFF
- .Extremely small
- Consume very little power
- Generate a negligible amount of heat.
- Life exceeds 100,000 hours (11 years) continuous use.

Light Sensors Styles and Uses

	Design/model series	Application
	Tubular Comet series	Small, easy to mount body enables mounting within machinery and other tight places. This sensor comes end sensing and right angle view sensor face, depending upon the type of mounting required.
	Harsh operational conditions E58-Series	Heavy-duty construction makes this sensor ideal for rugged environments.
	E65-SM-Series	A family of high performance DC light sensors in an economical compact enclosure. Diagnostic LEDs for correct target sensing.
	Fiber Optics	Made for fast response and for sensing in very tight areas. The cables are made of individual glass or plastic fibers and contain no electronics. Accessories to Comet series
	Miniature E71 series NanoView	A complete line of miniature light sensors for optimum placement and protection with no compromise in performance.
	Long-range sensors E67 series	The E67 series reliably detects target objects within its sensing range independently of variations in color, reflectance, contrast, and surface shape. Its Perfect Prox technology enables flawless background suppression, which makes these sensors ignore objects that are barely outside the target range.

**Fiber Optics**

Applying fiber optic technology to light sensors means applications with space restrictions are not a problem. A fiber optic cable can detect objects in locations too jammed for a standard sensor. Fiber optic cable is available in sizes as small as 0.002 inches (0.05 mm) in diameter.

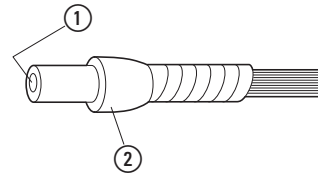

Glass Fiber Optic Cable  
 ① Glass fiber embedded in insulated material  
 ② Stainless steel sheath

A glass fiber optic cable is made up of a large number of individual glass fibers, sheathed for protection against damage and excess flexing.

Because light—rather than current—travels down these cables, the signal is unaffected by electromagnetic interference (EMI) and vibration.

Fiber optics can withstand high temperatures; standard glass up to 480°F (249°C) and specialized high temperature versions up to 900°F (482°C). Glass fibers can stand up to the harsh wash-down chemicals used in many food, beverage and pharmaceutical applications.

However, glass fibers have their disadvantages. They have a limited sensing distance, so they can be used only in tight areas. The maximum distance when using the thru-beam mode is 380 mm. In addition, these sensors have a relatively small sensing field. Also, small drops of water and dirt smudges can affect glass fibers applications.

**Modes of Detection**

In most applications, light sensors generate an output any time an object is detected.

**Light switching or dark switching**

"Light switching" means that an output signal will be generated if the light sensor receives light.

"Dark switching" means that an output signal will be generated if the light sensor does not receive any light.

• Light switching

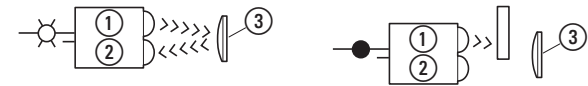

Reflected beam of light: Activated out- Blocked beam of light: No output signal put signal

• Dark switching

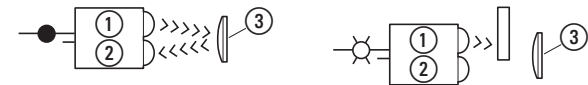

Reflected beam of light: No output sig- Blocked beam of light: Output signal acti- nal vated

- ① Station
- ② Detectors
- ③ Reflector

Operating modes

On page 107, we briefly discussed the four basic operating modes used with light sensors. These are:

- Thru-beam photoelectric sensors
- Retroflective sensing sensor (polarized)
- Diffuse reflective sensor
- Background suppression (Perfect Prox)

**Thru-beam photoelectric sensor**

Source and detector units face one another across an area. The column of light traveling in a straight line between the two lenses is the effective sensing beam. An object crossing the path has to completely block the beam to be detected.

Strengths:

- Long sensing distance (up to 800 ft)
- Highly reliable
- Can "see" through opaque objects.

Weaknesses:

- Two components to mount and wire.
- Alignment could be difficult with a longer distance detection zone.

Function:

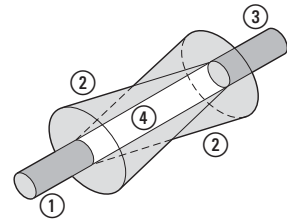

Normal state

- ① Station
- ② Field of view
- ③ Detectors
- ④ Effective light beam

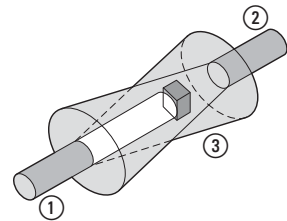

Target detected

- ① Station
- ② Detectors
- ③ Object blocks beam of light.

**Retroflective sensing sensor, polarized**

The source and detector are placed on the same side of the object to be detected, parallel to each other. A reflector is on the other side. This reflector sends the emitted light back to the detector.

When a target object passes between the source/detector unit and the reflector, the beam is no longer reflected, and the target is sensed. The target has to block the entire beam.

In certain cases, target objects with a shiny surface can result in false positives by activating the retroflective sensing sensor. A polarized retroflective sensing sensor can be used to prevent this. The polarizing filter on the sensor will ensure that the sensor will only detect light that has been offset by the reflector with a phase offset of 90°.

Strengths:

- Medium range sensing distance.
- Low cost.
- Ease of installation.
- Alignment does not need to be exact.
- A polarizing filter can be used to ensure that shiny surfaces will be reliably detected.

Weaknesses:

- Reflector must be mounted.
- Problems detecting clear objects.
- Dirt on reflector can hamper operation.
- Not suitable for detecting small objects.

Function:

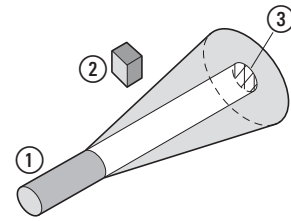

Normal state

- ① Source/detector
- ② Target
- ③ Retro-reflector

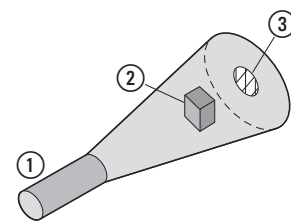

"Target object detected" state

- ① Source/detector
- ② Target object preventing reflection; i.e., target object detected.
- ③ Retro-reflector

**Diffuse reflective sensor**

The source and detector are positioned on the same side of the target. The two components are aligned so that their fields of view cross. When the target moves into the area, light from the source is reflected back to the detector.

Strengths:

- Application flexibility.
- Low cost.
- Easy installation.
- Easy alignment.
- Many varieties available for many application types.

Weaknesses:

- Short sensing distance (under 10 ft).
- Sensing distance depends on target size, surface and shape.

Function:

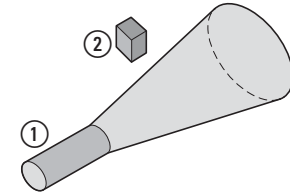

Normal state

- ① Source/detector
- ② Target

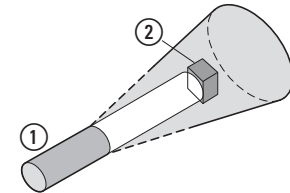

Target object detected

- ① Source/detector
- ② Target object reflecting beam of light; i.e., target object detected.

**Background suppression (Perfect Prox)**

This detection mode is a special type of diffuse reflective sensor. It combines extremely high sensing performance with a sharp optical cut-off. This enables the sensor to reliably detect target objects independently of their color, degree of reflection, contrast, and surface texture and ignore objects that are immediately outside the target range.

This method uses two different photo-detectors. For the Perfect Prox unit with a six-inch (150 mm) range, the near detector has a range of 0 to 24 inches (0 to 610 mm). The far detector has a range of 6 to 24 inches (150 to 610 mm).

Objects closer than six inches are detected only by the near sensor. Objects between 6 and 24 inches are detected by both detectors.

If the near-detector signal is stronger than the far-detector signal, the sensor output will be ON. If the far-detector signal is stronger than or equal to the near-detector signal, the sensor output will be OFF. The result is a sensor with a high light intensity difference over 150 mm combined with a sharp cut-off.

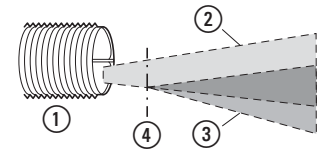

Perfect Prox Sensor

- ① Sensor
- ② Near sensing range
- ③ Far sensing range
- ④ Cut-off distance

Signal reserve

**Definition**

The term "signal reserve" is used to indicate a light sensor's excess light, i.e., the light that goes beyond the quantity of light required to detect an object.

A signal reserve of "1" for a specific range means that the quantity of light available is exactly enough to detect an object within the range in perfect conditions. In other words, the range at which the light intensity difference is "1" equals the sensor's maximum range.

Every sensor model comes with a signal reserve diagram that can be used to determine the signal reserve for the sensing distance used in a specific application.

However, we have to take into consideration the following real-world variables:

- Target size
- Target color
- Target surface texture
- Ability to block the beam of light
- Background
- Application environment

In the real world, there is contamination—dust, humidity and debris—that can settle on the lenses and reduce light transmission. Furthermore, each individual target may vary slightly from the next in color, reflectivity or distance from the sensor.

If you use a sensor with a signal reserve of exactly "1," it is highly likely that the target object will not be detected reliably. To be on the safe side, you will need a sensor with the largest possible signal reserve at the range you will be using. This ensures the sensor will continue to operate reliably when you need it. If the degree of soiling or pollution increases, you will need a larger signal reserve in order to compensate for the decrease in "visibility."

**Thru-beam photoelectric sensor**

The signal reserve for this type of sensor is the easiest to measure. The signal reserve is almost exclusively a function of the distance between the source and detector.

When implementing the excess gain for an application, start with the excess gain chart for the thru-beam sensor. Then consider:

- Misalignment of the two units.
- Dirt in the environment reduces gain.

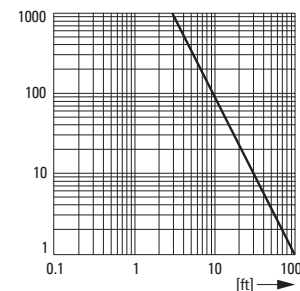

Typical Gain Curve for a Thru-Beam

If these sensors are spaced 30 ft (9 m) apart, the excess gain at that distance would be an excess gain of "10".

**Diffuse reflective sensor**

Almost every diffuse reflective sensor has a uniquely specific combination of lenses and beam angles. Accordingly, almost every sensor will have its own specific signal reserve curve.

Diffuse reflection ranges:

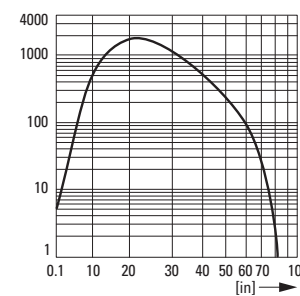

Perfect Prox long range sensor, example

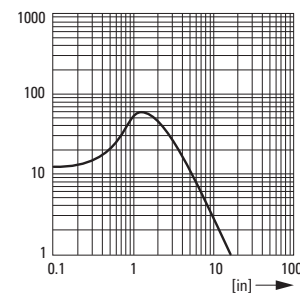

Short Range

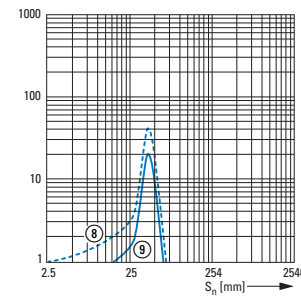

**Diffuse reflective sensor**

- ⑧ Comet 13102A typical
- ⑨ Comet 13102A minimum

Sensing range referenced to 90% reflective white target.

The signal reserve of a short-range sensor is large within the focused range and then decreases quickly. The source's beam of light and the detector's field of view converge a short distance behind the lenses. The energy present in that area is very high, allowing the detection of small targets. The sensor will ignore objects in the near background.

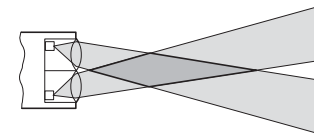

**Short Range**

In the case of a long-range sensor, the source's beam of light and the detector's field of view will be close to each other on the same shaft. The sensor's detection capabilities will extend across a larger distance. The signal reserve will peak a few centimeters away from the sensor and then decrease slowly as the distance increases.

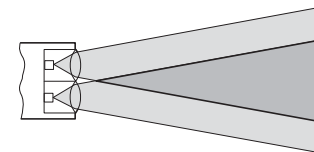

**Long range**

To sense into holes or cavities, or to pick up very small objects, use a focused diffuse reflective sensor. Or, a sensor with a very small light spot size. The source and detector are positioned behind the lens in order to focus the energy to a point. The excess gain is extremely high at this point and then drops off on either side of the sensing zone.

**Retroflective sensing sensor**

Calculating the signal reserve for a retroflective sensing sensor is done with a method similar to that used for diffuse reflective sensors.

With this type of sensor, excess gain and range are related to the light bouncing back from the reflector. Maximum operating range also depends upon lens geometry and detector amplifier gain.

The effective beam is defined as the actual size of the reflector surface.

The target must be larger than the reflector before the sensor will recognize the target and switch its output.

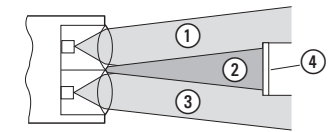

Effective Reflex Sensor Beam

- ① Emitted light beam
- ② Effective light beam
- ③ The detector's field of view
- ④ Retro-reflector

**Retroreflector / Corner cube retroreflector**

The range and signal reserve of a retroreflector will depend on the reflector's quality.

Retroreflectors deliver the highest signal return to the sensor. A corner reflector has 2,000- to 3,000 times the reflectivity of white paper.

A retroreflector is made up of three adjacent faces that are arranged at right angles to each other (hollow corner retroreflector).

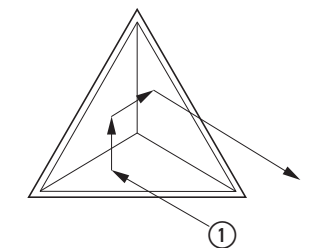

**Retro-reflector**

- ① Light beam

When a ray of light strikes one of the three adjoining sides, the ray is reflected to the second side, then to the third, and then back to its source in a direction parallel to its original course. Thousands of these prisms are molded into a rugged plastic reflector or vinyl tape material.

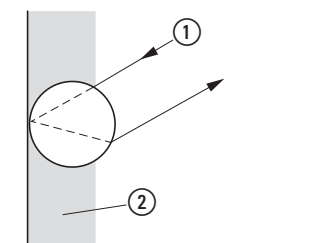

**Glass Bead**

- ① Light beam
- ② Opaque material



There are reflectors made up of glass beads placed on flat conductors that are intended for use in dispensers for package coding on conveyors. These reflectors are also available in sheets, and can be cut to size as necessary. The bead surface is typically rated at 200 to 900 times the reflectivity of white paper.

Only retroreflectors can be used with polarized retroreflective sensing sensors. The light reflected by the prisms in the corner cube retroreflector will have a phase offset of 90°. The polarizing filters on the source and detector will only let the light reflected by the retroreflector through. Glass bead reflectors cannot be used with polarized retroreflective sensing sensor.

**Contrast**

Contrast measures the ability of a light sensor to detect an object. A sensor's contrast is the ratio of the signal reserve in lighted conditions to the signal reserve in dark conditions. A ratio of 10:1 is desired. Contrast is important when a sensor has to detect semi-transparent objects or extremely small objects.

Each operating mode handles contrast differently.

- Thru-beam photoelectric sensor and retroreflective sensing sensor  
These operating modes are affected by:
  - Light permeability of an object or surface
  - Size of an object in relation to the beam size

- Diffuse reflective sensor  
This operating mode is affected by:
  - Distance of the object or surface from the sensor
  - Color or material of the object or surface
  - Size of the object or surface

The ideal application provides infinite contrast ratio of the detection event. This is the case when 100% of the light beam is blocked in the retroreflective or thru-beam operating mode. For diffuse sensing, this occurs when nothing is present. Taking the contrast ratio into account is important when the above situation is not the case (e.g., when detecting semitransparent objects). In certain cases, it may be necessary to use special low-contrast sensors designed for the specific application in question (e.g., featuring

Basic information

a detector for transparent objects).

**Environment**

The list below ranks the level of pollution in a range of typical application environments.

The signal reserve required in order to overcome atmospheric pollution will be larger the further down the list you go.

In addition, the light source and the reflector used in retroreflective sensing sensors and thru-beam photoelectric sensors may be located at different spots with different degrees of pollution.

For outdoor use, the environment can range from lightly dirty to extremely dirty.

**Level of Contamination Ranking**

Ranking	Description	Minimum required signal reserve
Relatively clean	No dirt buildup on lenses or reflectors	1.5 x
Slightly dirty	Slight buildup of dust, dirt, oil, moisture, and so on, on lenses or reflectors. Lenses should be cleaned on a regular schedule.	5 x
Moderately dirty	Obvious contamination of lenses or reflectors. Lenses are cleared occasionally or when necessary.	10 x
Very dirty	Heavy contamination of lenses. Heavy fog, mist, dust, smoke or oil film. Minimal cleaning of lenses takes place.	50 x

**Sensor Output Circuits**

Sensors interface to other control circuits through the output circuit. The control voltage type is a determining factor when considering output type. Control voltage types, whether AC, DC or AC/DC, can be categorized as either load-powered sensor or line-powered sensor.

**Load-Powered—Two-Wire Sensors**

Load-powered devices are similar to limit switches. They are connected in series with the controlled load. These devices have two connection points to the circuit and are often referred to as two-wire switches. The operating current is drawn through the load.

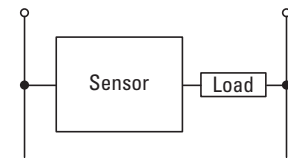

Load powered/two-Wire switch

When the switch is not operated, it must draw a minimum operating current referred to as off-state leakage current. Off-state leakage current is also sometimes referred to as residual current. This current is used to keep the sensor electronics active while it "looks" for a target. Residual current is not a problem for loads such as relays, motor starters, and so on (with low impedance). However, loads such as inputs of programmable logic controllers with high impedance require a leakage current of lower than 2 mA.

Currents larger than this may result in input devices such as PLCs (programmable logic control) interpreting the residual current as an ON signal. Most sensors require a residual current of 1.7 mA. If a particular PLC requires less than 1.7 mA, a load resistor can be connected in parallel to the input for the PLC load. The resistor lowers the current seen by the PLC so it doesn't false trigger.

The current needed to sustain the sensor when a target object is present is called minimum load or holding current. Depending on the specific sensor specifications, this current will be about 5 mA. The sensor will not work if the current drawn by the load is not large enough. Sensors with a 5 mA or less minimum holding current can be used with PLCs without concern.

**Line-Powered—Three-Wire Sensors**

Line-powered sensors derive their power from the line and not through the load. They have three connection points to the circuit, and are often referred to as three-wire switches.

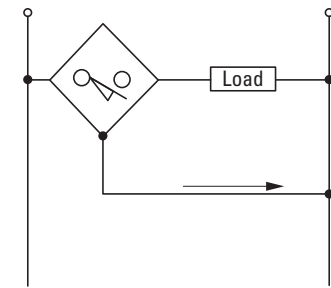

Line-powered/three-wire switches

The operating current the sensor pulls from the line is 20 mA.

**Two-Wire Sensors**

Although most sensors are three-wire devices, two-wire devices are also required sometimes. They are designed to be easy replacements for limit switches without the need to change wiring and logic.

Since two-wire sensors take their operating power from the load circuit, there is a voltage drop (approx. 7-9 V in AC-powered devices) across the switch when it is on.

If multiple two-wire switches are connected in series with the load, the voltage drop across the switches will increase. If multiple two-wire sensors are connected in parallel, the leakage current will increase. This needs to be taken into account when it comes to activating PLC inputs, for example.

Applications

Broken Tool Detection

Description	Catalog Number
E58 Perfect Prox Sensor	E58-30DP... E58-18DP...

This sensor is used to sense for the presence of the bit on a mill. The high sensing power and background suppression of the Perfect Prox allows reliable detection through high levels of cutting fluids, while ignoring objects just beyond the bit. The rugged harsh duty sensor survives constant exposure to lubricants, cutting fluids and flying metal chips.

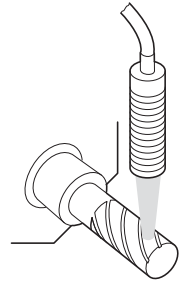

Broken Tool Detection

Description	Catalog Number
Tubular inductive sensor	E57... or iProx

A tubular sensor is used to detect the presence of a drill bit — should the drill bit be broken the sensor would signal a controller.

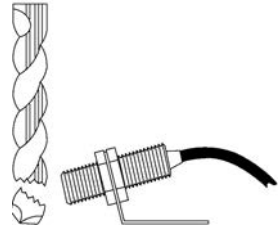

Machining process

Description	Catalog Number
Tubular inductive sensor	E57... or iProx

A ferrous only sensor is used in a process where aluminum is being machined. The ferrous only sensor ignores the aluminum (non-ferrous) chips from the machining process and only detects the ferrous target.

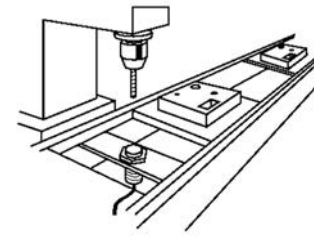

Tool Position

Description	Catalog Number
Tubular inductive sensor	E57... or iProx

A tubular sensor is used to detect the position of a tool chuck.

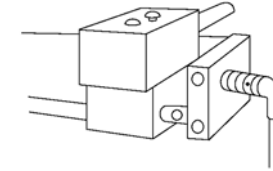

Bottle Filling Detection

Description	Catalog Number
Clear object sensor	E71-CON or E71-COP

A clear object sensor is used to sense the presence of bottles at a filling operation. The sensor offers high reliability in sensing clear bottles of different colors and thicknesses.

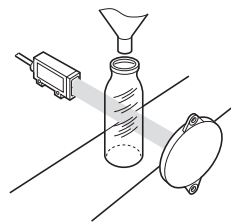

Process control engineering

Description	Catalog Number
Tubular capacitive Sensor	E53...

A capacitive sensor used to verify fill level of bottled water on a filling process line.

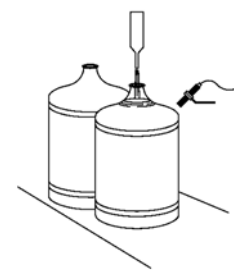

Conveyor System Control

Description	Catalog Number
Tubular inductive sensor	E57... or iProx

A tubular inductive sensor is used to detect the presence of metal carriers holding parts to be machined.

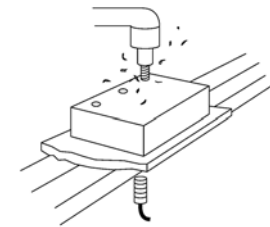

Stack Height Control

Description	Catalog Number
Comet series thru-beam photoelectric sensor	
Station	11100A
Detectors	12100A

A set of thru-beam photoelectric sensors determines the height of a scissor lift. For example, when the control is set for "dark-to-light" energize, the lift rises after a layer has been removed and stops when the next layer breaks the beam again.

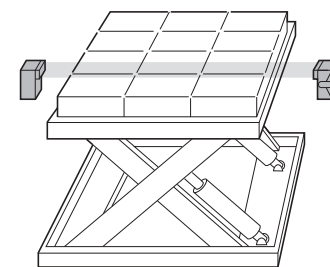



Carton Fill-Level Detection

Description	Catalog Number
Comet visible retro-reflective sensing sensor	14102A...
Comet diffuse reflective sensor with background suppression (Perfect Prox)	13103A...
Retro-reflector	6200A-6501

Two sensors work together to inspect the fill level in cartons on a conveyor. A diffuse reflective sensor senses the position of the carton and energizes the sensors located over the contents. If the sensor does not "see" the fill level, the carton does not pass inspection.

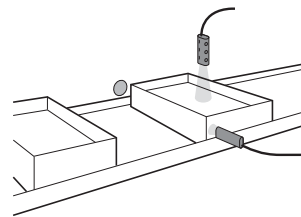

Lid Detection

Description	Catalog Number
Tubular inductive sensor	E57... or iProx

Two sensors are used to detect a can on a conveyor belt and to check whether it has a cover.

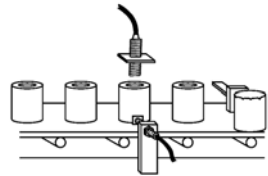

Tollbooth Control

Description	Catalog Number
Perfect Prox long range sensor	E67-LRDP...

The long range polarized retroreflective sensing sensors are used for the time control of a toll barrier. As soon as the car that has paid passes, the barrier closes in order to ensure that the next car stops. With the initiator E67 Long Range Perfect Prox you can mount the sensor on just one side instead of both. Plus with Perfect Prox, the E67 will detect cars with different colors and finishes while ignoring all other background objects. The rugged design makes it also suitable for continuous operation in extreme weather conditions.

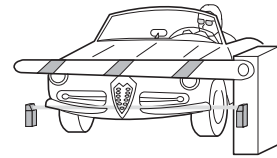

Liquid Level Detection

Description	Catalog Number
Tubular capacitive Sensor	E53...

A pair of capacitive sensors are used to sense high and low liquid levels in a tank through a sight glass. This arrangement starts a pump to fill the tank when the lower sensor is energized and shuts the pump off when the top sensor is energized.

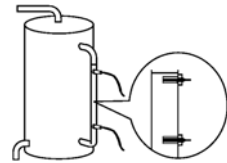

Bulk Material Detection

Description	Catalog Number
Tubular capacitive Sensor	E53...

A capacitive sensor is used to control fill level of solids such as plastic pellets in a hopper or bin.

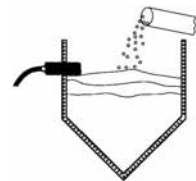

Parts Presence

Description	Catalog Number
Limit switch, inductive sensor	E57...
Comet Perfect Prox	1310...
Inductive sensor iProx	E59-M...

A sensor configured as a limit switch can be used to detect whether a component is present in an automatic assembly machine. The Comet detects all materials, colors and services and masks out the background. The iProx can be programmed to detect a particular material and thus to ignore all other materials.

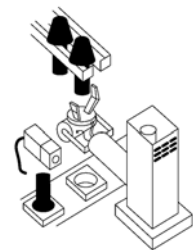

Parts Presence

Description	Catalog Number
Comet diffuse reflective sensor (Perfect Prox), 100 mm	13101A...

The sensor detects components with different heights from approx. 13 to 76 mm in a channel and can mask out the channel. Installation is simple and does not require any drilling or cutting of the channel.

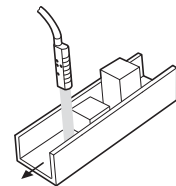

Filter Paper Length Control

Description	Catalog Number
A focused Comet diffuse reflective sensor	13102A...

A focused diffuse reflective sensor interfaces with a programmable length controller to measure a specific length of corrugated automotive filter paper. The controller detects the presence or absence of a corrugation. When a predetermined number of corrugations has been detected, the programmable controller directs a shear to cut the paper.

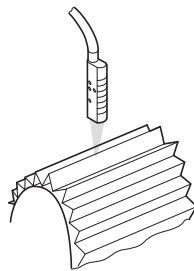

Speed monitoring

Description	Catalog Number
Tubular inductive sensor	E57... or iProx

A tubular sensor is used to detect the presence of set screws on a shaft hub providing a control device with signals for speed regulation or detection of rotation.

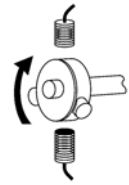

Motion Control

Description	Catalog Number
Tubular inductive sensor	E57... or iProx

A pair of tubular sensors is used to determine full open and fully closed valve position.

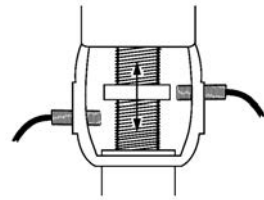

Paper detection

Description	Catalog Number
Comet Perfect Prox, 50 mm series, right angled	13104R...

Right angle viewing and compact size allow the sensor to be mounted in the tight confines of paper handling systems. High resolution and sharp optical cut-off ensure that background machinery will be ignored while paper will be detected regardless of color and texture.

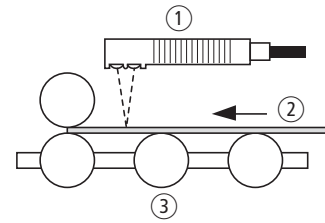

Clear Plastic Web Break Detection

Description	Catalog Number
Comet series 150 mm focus diffuse reflective sensor	13107A...

The clear web is detected by an extremely sensitive diffuse reflective sensor. Its short detection range makes it immune to reflective objects in the background. The extremely high excess gain helps it ignore reflection caused by fluttering of the web.

Damage Warning

Description	Catalog Number
Comet E58 series thru-beam photoelectric sensor	
Station	E58-30TS...
Detectors	E58-30TD...

Source and detector are mounted at opposite ends of a long warehouse storage shelf with the beam situated a safe distance below overhead obstacles (lighting, cable ducts, gas lines, etc.). If a forklift operator interrupts the beam while moving a load, a siren or flashing light will warn him to stop before any damage occurs.

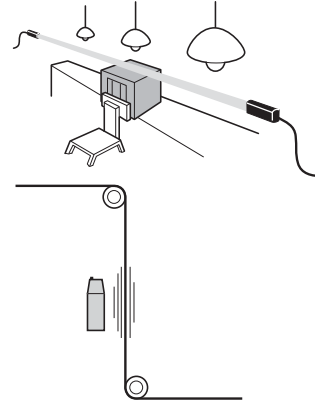



## Worldwide export of machines and plants

European machine and system building and worldwide exports are closely related. Even if you don't export your machines at present, you should be prepared for it in the future. Eaton provides switchgear and protective devices with all the essential approvals and certificates for machine and system building. In most countries around the world, conformity with international standards is the sole requirement for successful exports. This is because components in these locations are governed by compliance with well known and established IEC standards. In this respect, the European CE mark is not only the passport for exports within Europe but also far beyond its borders.



### World market equipment for machine building

Nearly all the switchgear and protective devices of Eaton's Moeller® series are world market devices. Each product line thus carries all the approvals and certification marks required for worldwide use.

These product lines include those for

- Pilot devices, limit switches
- Contactors and various timing and special relays
- Motor-protective circuit-breakers and relays
- Electronic components and systems.

With circuit-breakers and switch-disconnectors, Eaton offers IEC devices for use in most countries in the world and NA devices with virtually the same dimensions and the same accessories for the North American market. This considerably simplifies device selection since the North American standards often involve the need for considerably different technical specifications.

## Electrical engineering products and their applications are not harmonized internationally.



The greatest differences to the IEC world are in North America, i.e. the USA and Canada. For many newcomers to the export business, it is initially surprising to experience the very different approaches and solutions.

Special components, such as handles for main switches that can only be operated by the intentional switching of an

additional handle when the control panel door is opened, may sometimes be required for export to North America. Likewise, the European motor-protective circuit-breaker is only accepted with an upstream protective device or with larger air and creepage distances at the incoming terminals. Eaton is the competent partner of choice for export-related issues here.

## Qualified information is a critical key to success



The Eaton Main Catalogue for Moeller® series products provides reliable information for machine and panel builders on the approval of components deployed for North American market. Each selection page provides information such as the relevant product standard, the E-File Number, the Category Control Number or the CSA Class Number. Many customers incorporate this information in their parts lists in order to be well prepared for the acceptance procedures.

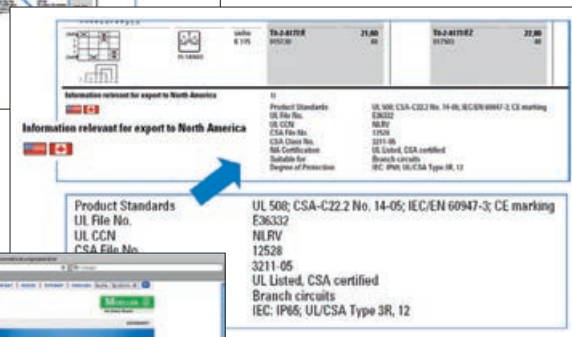

Up to 13 data items are listed here for each product, such as the suitability for use in feeders or branch circuits, the maximum operating voltage, or the North American degree of protection, such as UL / CSA Type 4X. The Main Catalogue also contains a glossary with explanations of the American terms.



The link <http://www.moeller.net/eaton-approbationen/en/index.jsp> shows the relevant approvals or permits for each component type. This therefore enables you to view the certificates provided or, depending on the test authority, also the product report. The information given is the same as what is provided in the databases of the authorities.

Anyone wishing to avoid unfortunate experiences, should make use beforehand of the large number of publications that Eaton is offering on the issue of exports to North America. They contain the implementation of the codes & standards and a description of different practices.

These technical articles can be accessed via <http://www.moeller.net/en/company/news/publications/index.jsp>. They can be downloaded or ordered free of charge.

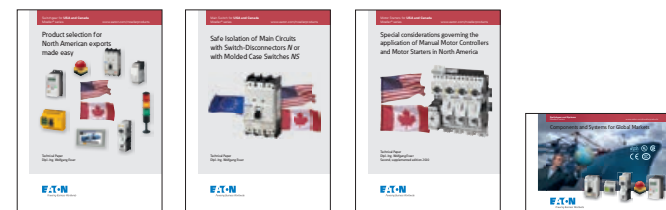



# Eaton Catalogs in the App Store – all catalogs close at hand!

In order to meet the needs of increasingly mobile customers and employees, Eaton is offering a mobile solution for communication and product information.

## Clearly designed shelf view

The Eaton Catalogs app offers an outstandingly clear user interface and several fully developed functions. In the form of a shelf view, the user is provided with a clear overview of Eaton's latest product catalogs. These can be leafed through on the fly or downloaded to the device – for situations when there is no Internet access. Choose for yourself which catalogs are of interest and keep up-to-date using the Update function.

## Intuitive browsing, searching and finding

Users can simply browse through the catalogs with intuitive navigation ensured. A linked table of contents, thumbnail views and a rapid search function are also provided for finding information quickly and conveniently.

## Linked data sheets

It is often the case that product information is required which is not available in the product catalogs. The "Eaton Catalogs" contain article numbers and type designations that are linked to the Online Catalog. This enables the user to access highly detailed production information in the form of a technical data sheet. From here other documents such as installation instructions and technical publications can be called up.

Whether on the building site, at the customer, on the train or at home – "Eaton Catalogs" make sure that all product information is close at hand.



# Eaton Online Catalog – find product details quickly and efficiently!

You can find comprehensive up-to-date product information at <http://ecat.moeller.net>

## Lookup

You can search by keywords, product names, article numbers, technical data: The search understands everything and takes you straight to the product you're looking for.

## Graphical navigation

Graphical representation of the fields of application and product groups.

## Selection aids

Tailored to the typical expert's approach, this search aid helps you quickly find the product you need.

## Data sheets

For every article the catalog can generate a technical data sheet, which you can convert to a PDF file for printing or saving with a single click.

## Parts lists



From your search results you can create a parts list that you can then send to your Eaton sales partner as a query.

You can find comprehensive up-to-date information about Eaton's automation products and switchgear in our Online Catalog.



HTML data sheet; can be saved as PDF file.



Item	Qty	Photo	ATSC no.	Part no.	Short Text
1	1		111017	ES4P-221-0M001	Safety control relay, 24 V DC, 2-line
2	1		229758	FAK-COMBINATION	Complete unit
3	1		294851	M225-DOLM-GR X110	Double act. Alum. flat, off-button and
4	1		290090	CBM15-01 (110V/50Hz, 120V/60Hz)	Contactor, 7.5kV/400V, AC-operated
5	1		138516	PK255/170-65	PK255 - Trip block Standard B-55A

Parts list, e.g. for queries to Eaton Sales.



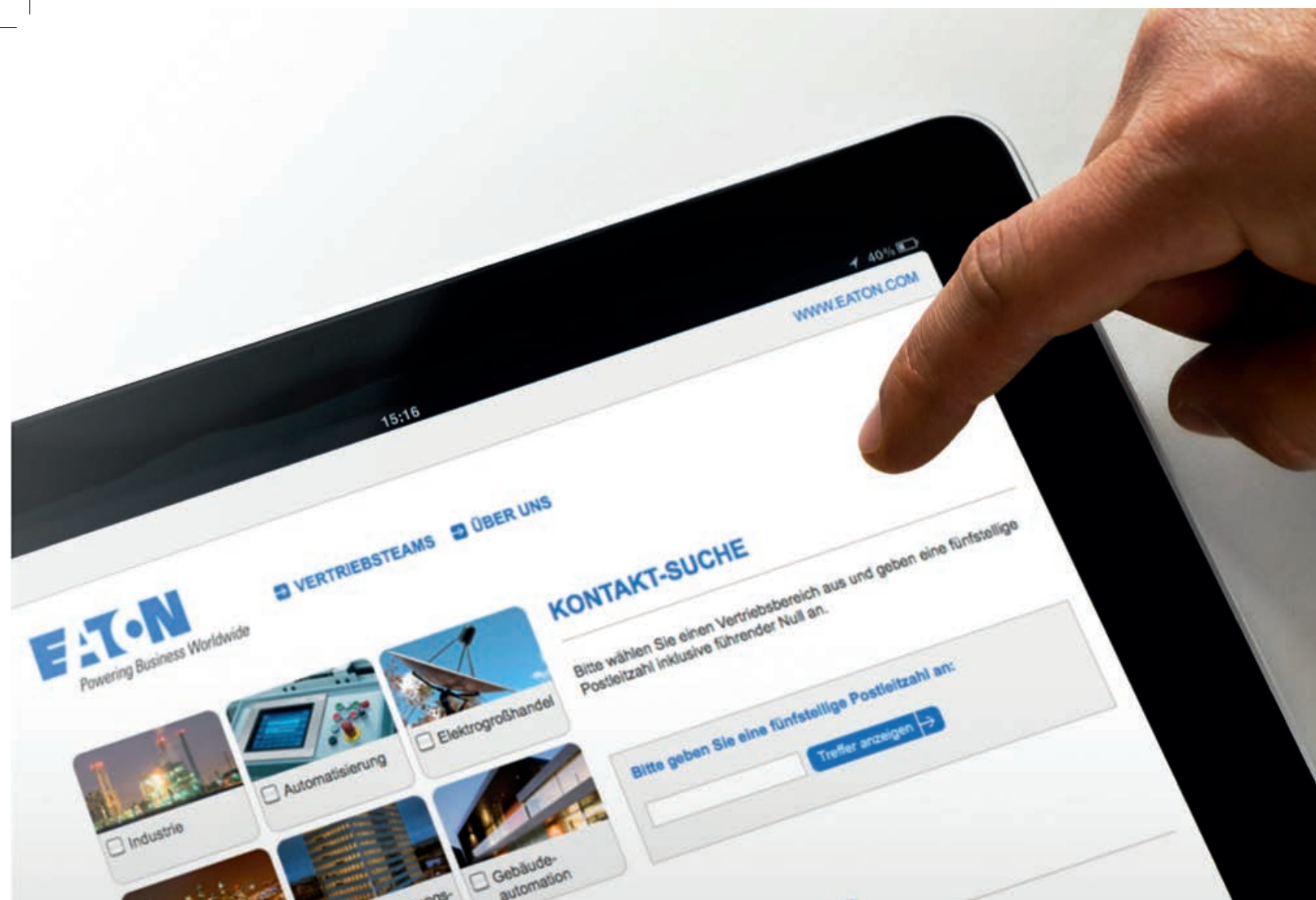

## How to find the right contact:

At Eaton, an efficient customer relationship management is standard practice.

This guarantees you our support right from the start of any new project. Use these contact addresses to find your personal customer contact:

In just a few steps we can direct you to specialist local support specifically for your business sector.

Your customer contact in your region:    Your customer contact worldwide:

→ <http://salesbonn.moeller.net>

→ [www.eaton.eu/electrical/contact](http://www.eaton.eu/electrical/contact)



# The power of fusion

1874 1886 1893 1899 1906 1908 1911 1962 1963 1983 1990 1998 1999

There's a certain energy at Eaton. An energy produced by the combination of globally established engineering companies into one brand. One brand that cleverly and efficiently meets all your requirements in the field of power management and industrial automation. Energy for our customers worldwide – That's what we mean by 'Powering Business Worldwide'. From power distribution and control to industrial automation right through to uninterruptible power supply.

Eaton helps you to manage your entire power system proactively and efficiently. For this we offer you electrical solutions that make your applications safer, more reliable and highly efficient. Visit us at [www.eaton.com/electrical](http://www.eaton.com/electrical).

All the above are trademarks of Eaton Corporation or its affiliates. The Westinghouse brand name is used by temporary license in Asia Pacific. ©2009 Eaton Corporation.



## Service and consulting for UPS systems and hydraulic solutions.

Further developing relations with our customers is particularly important to us. Your requirements and suggestions will be passed on promptly to the relevant specialists. After all, we take up the challenges you give us as if they were our own.



### Are your questions about uninterruptible power supplies (UPSs)?

#### Technical support

If you have any questions about our products and for technical advice send an email to our support team:

[supportgermany@eaton.com](mailto:supportgermany@eaton.com)

or contact our telephone hotline at

Tel.: +49 (0)7841 604 - 334

#### Service

If you have a problem or a fault on one of our products contact us by email:

[servicegermany@eaton.com](mailto:servicegermany@eaton.com)

or contact us by phone at:

Tel.: +49 (0)7841 604 - 334

We can be contacted here between Monday – Thursday from 08.00 – 17.00 CET and Friday from 08.00 – 16.00 CET.

### Are your questions about hydraulic solutions?

Please contact the help desk of our Customer Service in Baden-Baden. This service will put you in touch with a customer contact in your locality.

#### Our customer service:

Eaton Hydraulics Group  
 Dr.-Reckeweg-Straße 1  
 D-76532 Baden-Baden  
 Tel.: +49 (0)7221 682 - 0  
 Fax: +49 (0)7221 682 - 788  
 Email: [customersupportmea@eaton.com](mailto:customersupportmea@eaton.com)

## Eaton's After Sales Service

This is the new name of Moeller's tried and trusted Field Service. Only the name has changed. The reliable and first-class service has stayed the same. Further information and general terms and conditions can be found at [www.moeller.net/en/support/fieldservice/index.jsp](http://www.moeller.net/en/support/fieldservice/index.jsp).

#### Service specialists

Use our service personnel. Extensive know-how, combined with many years of experience and state-of-the-art equipment to help you find a solution for your tasks.

#### Material

Components, assemblies and spare parts for the Eaton product range are available for your applications.

#### Service products

Eaton's After Sales Service offers the right service packages for your products.

#### Hotline

Free hotline for round-the-clock support.  
 +49 (0)180 522 3822 (24/7)  
 0.12 euros per minute for calls from within the German Telecom network

#### Onsite service

Repair and replacement service for Eaton devices.

#### Repairs

Onsite service, analysis, conversions, expansions and maintenance.

#### Online services

Downloads, FAQs and interactive troubleshooting



Eaton is dedicated to ensuring that reliable, efficient and safe power is available when it's needed most. With unparalleled knowledge of electrical power management across industries, experts at Eaton deliver customized, integrated solutions to solve our customers' most critical challenges.

Our focus is on delivering the right solution for the application. But, decision makers demand more than just innovative products. They turn to Eaton for an unwavering commitment to personal support that makes customer success a top priority. For more information, visit [www.eaton.eu](http://www.eaton.eu).

To contact an Eaton salesperson or local distributor/agent, please visit [www.eaton.eu/electrical/customersupport](http://www.eaton.eu/electrical/customersupport)

Changes to the products, to the information contained in this document, and to prices are reserved; so are errors and omissions. Only order confirmations and technical documentation by Eaton is binding. Photos and pictures also do not warrant a specific layout or functionality. Their use in whatever form is subject to prior approval by Eaton. The same applies to Trademarks (especially Eaton, Moeller, Cutler-Hammer). The Terms and Conditions of Eaton apply, as referenced on Eaton internet pages and Eaton order confirmations.

Eaton Industries GmbH  
Hein-Moeller-Str. 7-11  
D-53115 Bonn/Germany

© 2013 by Eaton Corporation  
All rights reserved  
Printed in Germany 02/13  
Publication No.: CA05303\_EN-INT  
ip February 2013  
Article No.: 171796



Eaton is a registered trademark of Eaton Corporation  
All other trademarks are property of their respective owners.



Product range catalog for sensors

Inductive sensors  
Optical sensors  
Capacitive sensors



# Product range catalog

## Sensors – products, basic information, applications



## X-ON Electronics

Largest Supplier of Electrical and Electronic Components

*Click to view similar products for [Eaton](#) manufacturer:*

Other Similar products are found below :

[BK1-S506-2-R](#) [FHN31G1](#) [CH222B](#) [SAMI-2I](#) [SAMI-6I](#) [LPN-RK-25SP](#) [ZE6](#) [ZE9](#) [LPN-RK-15SP](#) [LPN-RK-3SP](#) [SAMI-1I](#) [2499](#) [GMC-500MA](#) [AT-20](#) [BK/SC-45](#) [AGC-1-2](#) [BK/MDA-15](#) [BK/MDA-1](#) [BK/C519-1A](#) [BK/MDL-3-2/10](#) [89096-015](#) [8943K28](#) [8946K153](#) [8961K155](#) [M22-DH-Y](#) [M22-DLH-Y](#) [M22-D-R-GB0/K11](#) [M22-LCH-R](#) [M22-L-R/R](#) [M22-WLK3-B](#) [63ET](#) [6422](#) [6580](#) [CTX20-16-52LP-R](#) [CWL530FI](#) [CXM/CO/GP/R/BB](#) [6HD36](#) [714125](#) [MBO-2](#) [7314K36](#) [7321K2](#) [ETF-200MA](#) [F02A-1-1/2A](#) [F02A-1-1/2AS](#) [F02A-1AS](#) [F02A-3/4A](#) [F03A250V10A](#) [F03A250V12A](#) [MDA-2-8/10-R](#) [MDA-30A](#)