



IDEALPOWER
experts in power conversion

SPECIFICATION FOR APPROVAL

CUSTOMER: _____

DESCRIPTION: I.T.E. POWER SUPPLY REV: (A0)

MODEL NO: HK-AY-240A100-CP PART NO: HKSC-170003

DESIGNED NO: 170003-0103 DATE: JAN.03th.2017

| CUSTOMER APPROVED SIGNATURES | | | VENDOR APPROVED SIGNATURES | | |
|------------------------------|--|--|---|---|---|
| | | |  |  |  |

Ideal Power, 14 Larks Way, Tree Beech Enterprise Park, Gunn, Barnstaple, Devon, England EX32 7NZ

Web: www.idealpower.co.uk email: sales@idealpower.co.uk TEL +44 (0) 845 2603400 Fax +44 (0) 845 2603401



| | | | |
|---------------|---------------------|--------------|------------|
| MODEL NO. : | HK-AY-240A100-CP | PAGE NO. : | 1 OF 13 |
| PART NO. : | HKSC-170003 | ISSUED DATE: | 2017.01.03 |
| DESCRIPTION : | I.T.E. POWER SUPPLY | REV: | (A0) |

CONTENTS

1. INTRODUCTION
2. INPUT REQUIREMENTS
3. OUTPUT REQUIREMENTS
4. EFFICIENCY
5. LINE REGULATION
6. HOLD UP TIME
7. TURN ON TIME
8. TEMPERATURE COEFFICIENT
9. DIELECTRIC STRENGTH (Hi-Pot) TEST
10. INSULATION RESISTANCE
11. PROTECTION
12. ENVIRONMENTAL CONDITIONS
13. EMI/ EMC
14. RELIABILITY AND QUALITY CONTROL
15. SAFETY
16. OVERALL DRAWING
17. PACKING
18. MARKING
19. TEST REPORT



| | | | |
|---------------|---------------------|--------------|------------|
| MODEL NO. : | HK-AY-240A100-CP | PAGE NO. : | 2 OF 13 |
| PART NO. : | HKSC-170003 | ISSUED DATE: | 2017.01.03 |
| DESCRIPTION : | I.T.E. POWER SUPPLY | REV: | (A0) |

1.0 INTRODUCTION

This document specifies a switching power supply with a output of +24V, and electronic process. The switching power supply will provide power for technology equipments including electrical business equipment. The adaptor meets the requirement of lead free and RoHS.

2.0 INPUT REQUIREMENTS

2.1 Input Voltage Range: 100(-10%)VAC to 240(+10%)VAC

2.2 Input Frequency Range: 47 Hz to 63 Hz

2.3 Input Power Consumption at no-load : 0.1W Max

Test condition will be tested after No load operating for 30min then measure it.

2.4 Input In-rush Current: 60A Max

2.5 Input Current: 0.8A Max

3.0 OUTPUT REQUIREMENTS

3.1 Output Voltage: +24V

3.2 Output Regulation: 22.8-25.2V

3.3 Output Load Range: 0-1.0A

3.4 Output Ripple & Noise: 200mV Max @20MHz bandwidth with
10UF/50V capacitance and 104/50V ceramic capacitor.

4.0 EFFICIENCY: $\geq 86.2\%$ @average of 25/50/75/100% loads 115&230VAC input

Test condition will be tested after full load operating for 30min then measure it.

5.0 LINE REGULATION: $\pm 2\%$ maximum

6.0 HOLD UP TIME: 10ms Min at 110VAC full load.

7.0 TURN ON TIME: 2S Max at 110VAC full load.



| | | | |
|---------------|---------------------|--------------|------------|
| MODEL NO. : | HK-AY-240A100-CP | PAGE NO. : | 3 OF 13 |
| PART NO. : | HKSC-170003 | ISSUED DATE: | 2017.01.03 |
| DESCRIPTION : | I.T.E. POWER SUPPLY | REV: | (A0) |

8.0 TEMPERATURE COEFFICIENT: 0.05%/°C

9.0 DIELECTRIC STRENGTH (Hi-Pot) TEST

9.1 Primary to Secondary :AC 3000 Vrms ,4mA,1minute for type test,
2 second for production test.

10.0 INSULATION RESISTANCE

Primary to secondary: 50M OHM to 500VDC.

11.0 PROTECTION

11.1 Input Protection

The switching power supply has a 2 Amps inner current fuse to protect itself.

11.2 Output Protection

11.2.1 Output Current:

Overload conditions shall decrease the output current. Removal of an output overload shall provide automatic recovery for the output voltage.

11.2.2 Short Circuit Protection: Auto Recovery.

| | | | |
|---------------|---------------------|--------------|------------|
| MODEL NO. : | HK-AY-240A100-CP | PAGE NO. : | 4 OF 13 |
| PART NO. : | HKSC-170003 | ISSUED DATE: | 2017.01.03 |
| DESCRIPTION : | I.T.E. POWER SUPPLY | REV: | (A0) |

12.0 ENVIRONMENTAL CONDITIONS

The switching power supply can withstand the following environmental conditions:

12.1 Storage Temperature: -20°C ~ +70 °C

Relative Humidity: 10% ~ 95%

12.2 Operation Temperature: 0°C~40°C

Relative Humidity: 10%~95%

13.0 EMI / EMC

The switching power supply has designed to meet the following safety standards:

FCC PART 15 Class B

CISPR 22:2008(Ed 6.0)AS/NZS CISPR 22:2009+A1:2010; CISPR 24:2010(Ed 2.0)AS/NZS CISPR 24:2013

EN55022:2010/AC:2011 IEC61000-4-3:2006/A1:2007/A2:2010

EN61000-3-2:2014 IEC61000-4-4:2012

EN61000-3-3:2013 IEC61000-4-5:2014

EN55024:2010 IEC61000-4-5:2014

IEC61000-4-2:2008 IEC61000-4-6:2013

IEC61000-4-8:2009

IEC61000-4-11:2004

14.0 RELIABILITY AND QUALITY CONTROL

14.1 Burn-in

The burn-in test will be performed at least 2 hours at 40 centigrade degrees under full load condition.

14.2 MTBF

When the operation is complying with this specification, the switching power supply s MTBF will be 50,000 hours at 25 centigrade degrees.

15.0 SAFETY

The switching power supply has designed to meet the following safety standards:

UL 60950-1, 2nd Edition,2014-10-14 CSA C22.2 NO.60950-1-07, 2nd Edition,2014-10

EN60950-1:2006+A11+A12+A2 BS EN60950-1:2006+A2

AS/NZS 60950.1:2015



IDEALPOWER

experts in power conversion

| | | | |
|---------------|---------------------|--------------|------------|
| MODEL NO. : | HK-AY-240A100-CP | PAGE NO. : | 5 OF 13 |
| PART NO. : | HKSC-170003 | ISSUED DATE: | 2017.01.03 |
| DESCRIPTION : | I.T.E. POWER SUPPLY | REV: | (A0) |

16. OVERALL DRAWING

UNIT: mm
COLOR: BLACK

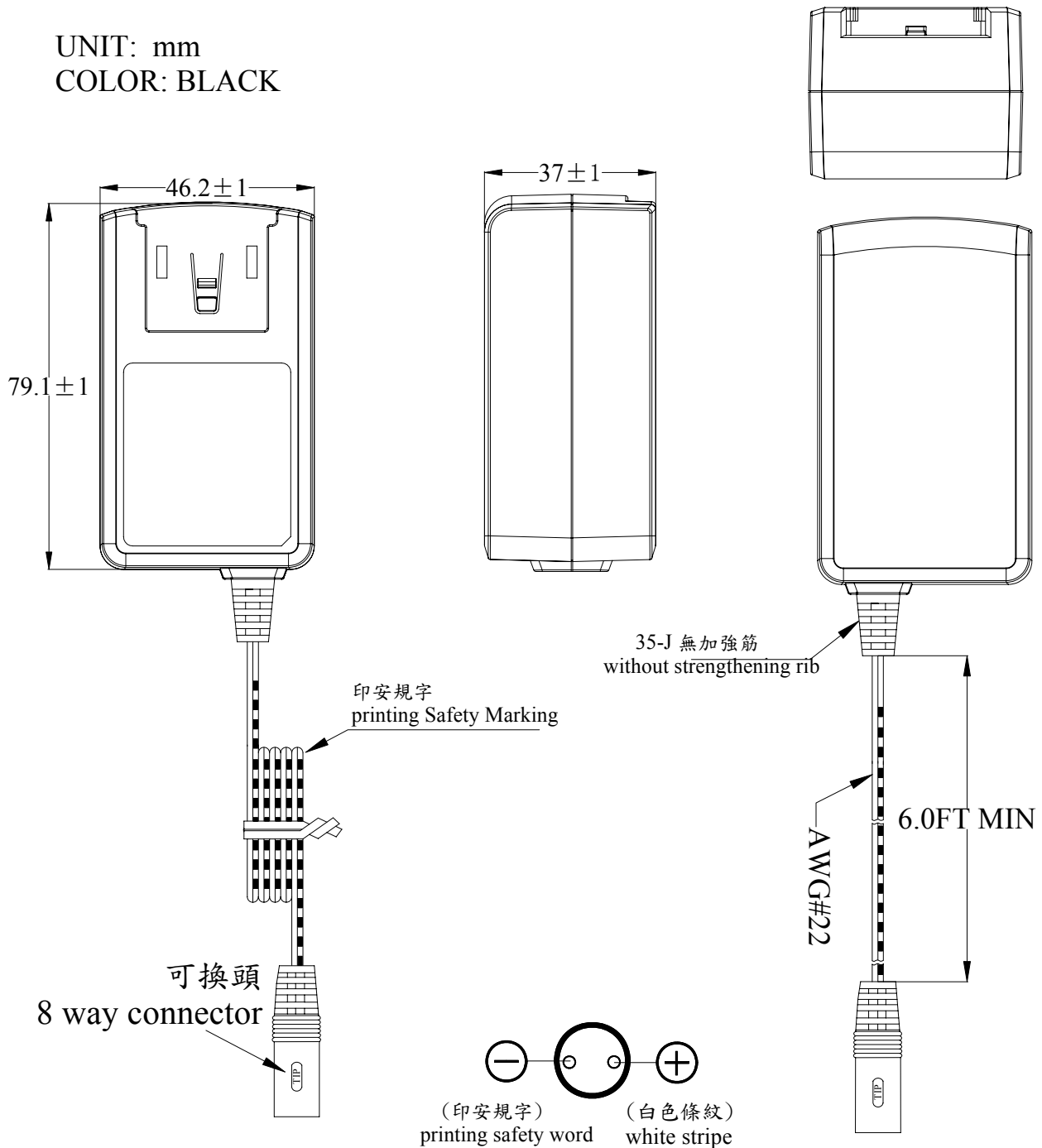

| | | | |
|---------------|---------------------|--------------|------------|
| MODEL NO. : | HK-AY-240A100-CP | PAGE NO. : | 6 OF 13 |
| PART NO. : | HKSC-170003 | ISSUED DATE: | 2017.01.03 |
| DESCRIPTION : | I.T.E. POWER SUPPLY | REV: | (A0) |

UNIT: mm

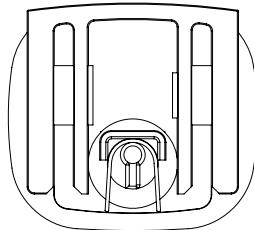
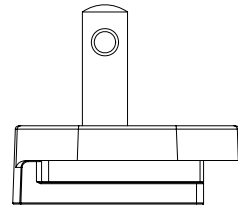
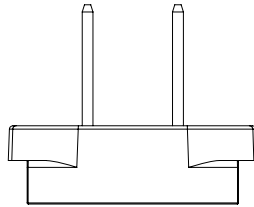
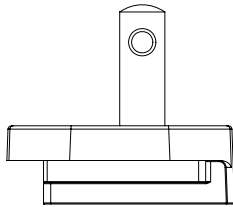
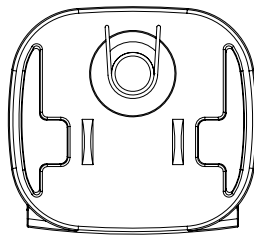

UL



IDEALPOWER

experts in power conversion

| | | | |
|---------------|---------------------|--------------|------------|
| MODEL NO. : | HK-AY-240A100-CP | PAGE NO. : | 7 OF 13 |
| PART NO. : | HKSC-170003 | ISSUED DATE: | 2017.01.03 |
| DESCRIPTION : | I.T.E. POWER SUPPLY | REV: | (A0) |

UNIT: mm

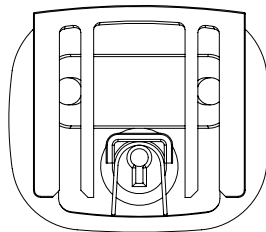
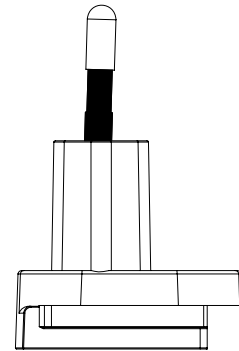
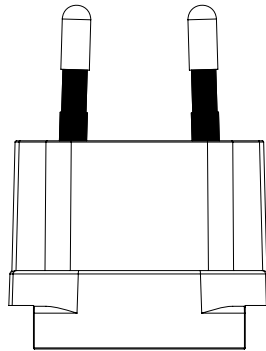
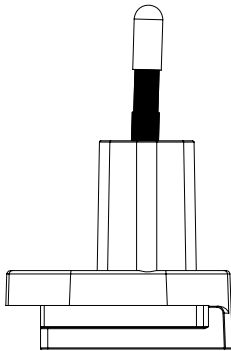
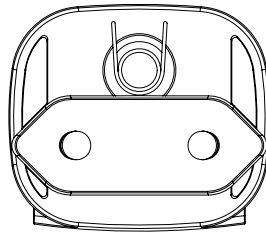

TUV



| | | | |
|---------------|---------------------|--------------|------------|
| MODEL NO. : | HK-AY-240A100-CP | PAGE NO. : | 8 OF 13 |
| PART NO. : | HKSC-170003 | ISSUED DATE: | 2017.01.03 |
| DESCRIPTION : | I.T.E. POWER SUPPLY | REV: | (A0) |

UNIT: mm

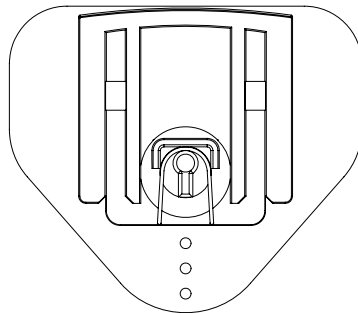
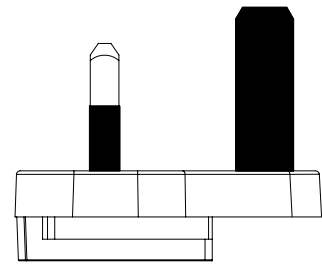
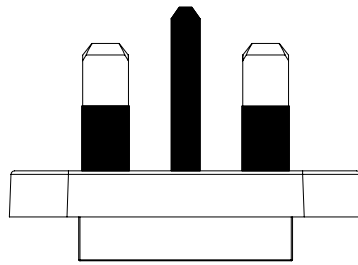
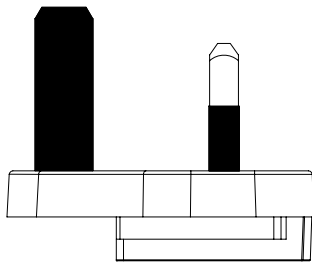
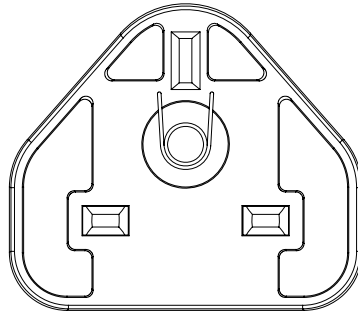

UK



| | | | |
|---------------|---------------------|--------------|------------|
| MODEL NO. : | HK-AY-240A100-CP | PAGE NO. : | 9 OF 13 |
| PART NO. : | HKSC-170003 | ISSUED DATE: | 2017.01.03 |
| DESCRIPTION : | I.T.E. POWER SUPPLY | REV: | (A0) |

UNIT: mm

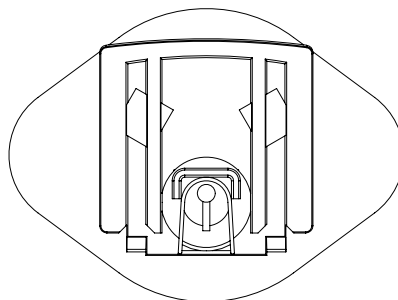
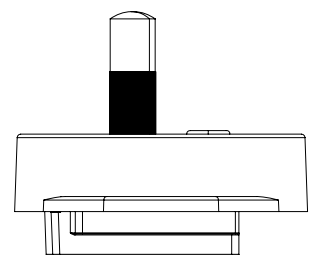
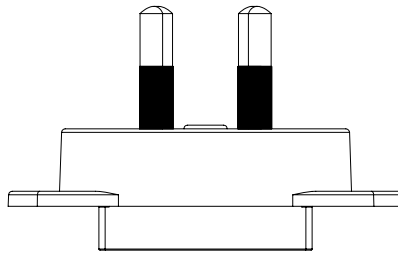
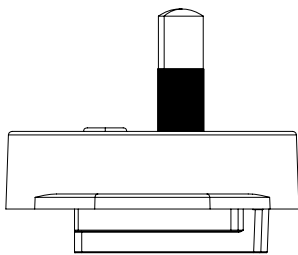
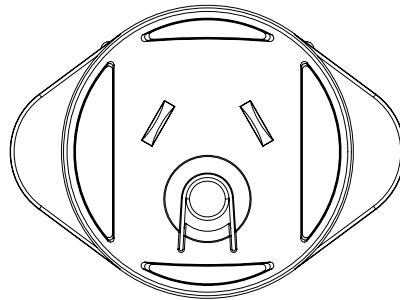

SAA



| | | | |
|---------------|---------------------|--------------|------------|
| MODEL NO. : | HK-AY-240A100-CP | PAGE NO. : | 10 OF 13 |
| PART NO. : | HKSC-170003 | ISSUED DATE: | 2017.01.03 |
| DESCRIPTION : | I.T.E. POWER SUPPLY | REV: | (A0) |

UNIT: mm

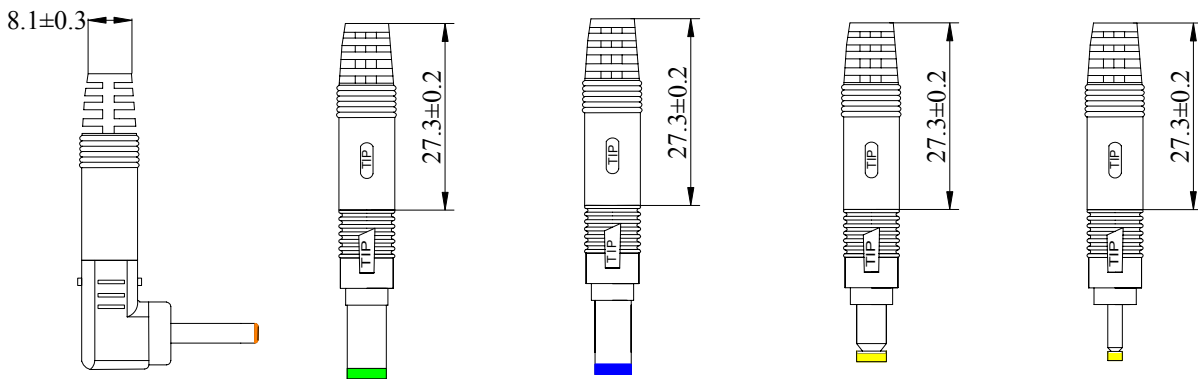
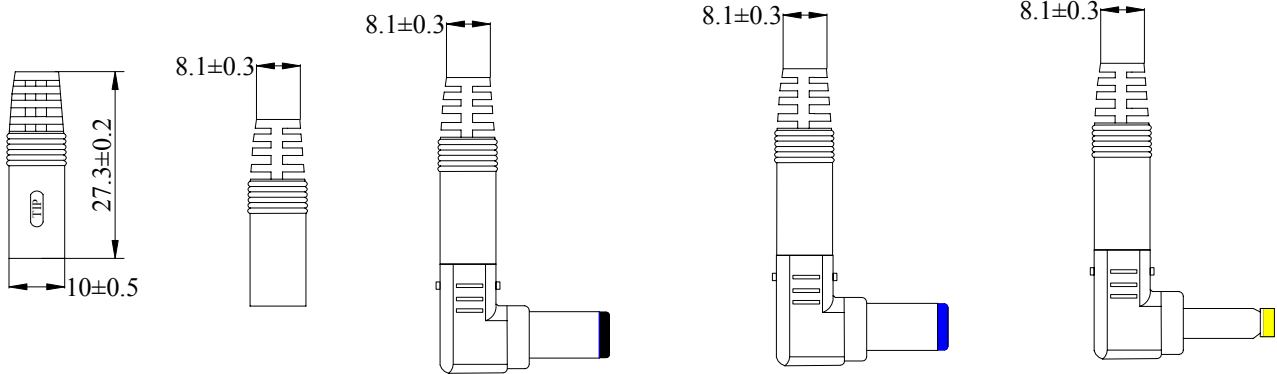



| | | | |
|---------------|---------------------|--------------|------------|
| MODEL NO. : | HK-AY-240A100-CP | PAGE NO. : | 10 OF 13 |
| PART NO. : | HKSC-170003 | ISSUED DATE: | 2017.01.03 |
| DESCRIPTION : | I.T.E. POWER SUPPLY | REV: | (A0) |

UNIT: mm

WARNING!

Please don't insert article alone at the wall.

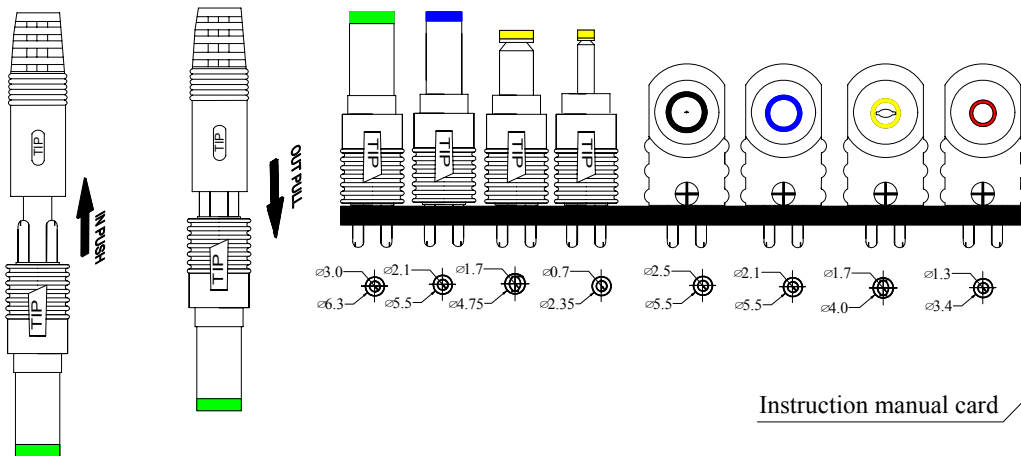
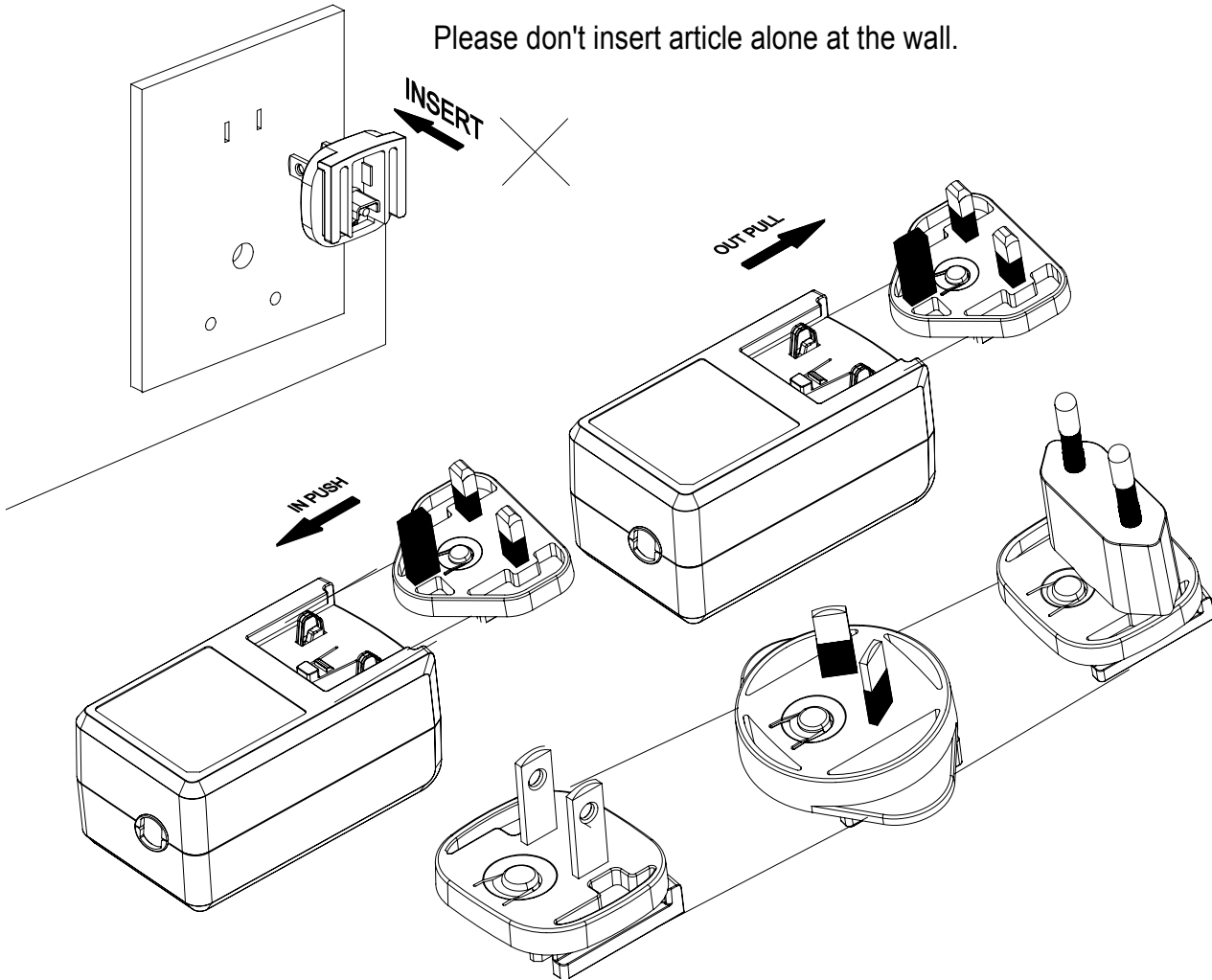

Instruction manual card

Output connector instructions.

Supplied by Ideal Power Ltd, Acorn House, Tree Beech Enterprise Park, Gunn, Barnstaple, Devon, England EX32 7NZ Tel. +44 (0) 845 2603400

Please ensure the correct polarity is observed before connecting to any user equipment.

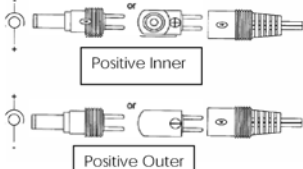

Positive Inner

Positive Outer

| | | | |
|---------------|---------------------|--------------|------------|
| MODEL NO. : | HK-AY-240A100-CP | PAGE NO. : | 10 OF 13 |
| PART NO. : | HKSC-170003 | ISSUED DATE: | 2017.01.03 |
| DESCRIPTION : | I.T.E. POWER SUPPLY | REV: | (A0) |

17. PACKING

17.1 Inner Box

UNIT: mm

BOX(
 Normal BOX
 Corrugated BOX)

Length: 120

Width: 75

Height: 50

Label: 1

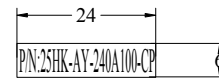

Label: 2

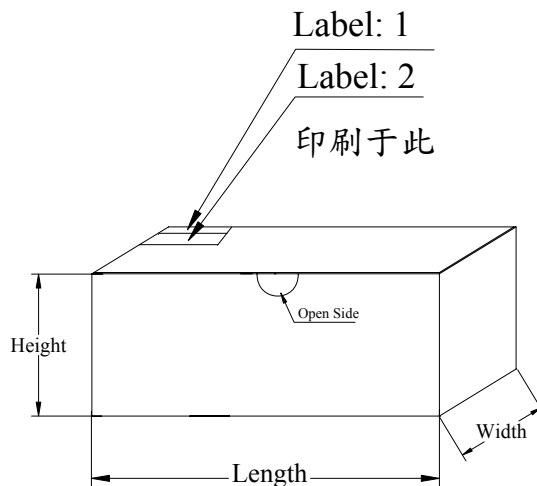
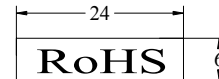

NOTICE:

Its probably different from the white box of the sample and the figure dimension.
The white box is used to pack during product.

注意: 樣品使用的小白盒尺寸可能與此圖面尺寸不同, 此圖面尺寸是用于生產時的包裝。



IDEALPOWER

experts in power conversion

| | | | |
|---------------|---------------------|--------------|------------|
| MODEL NO. : | HK-AY-240A100-CP | PAGE NO. : | 11 OF 13 |
| PART NO. : | HKSC-170003 | ISSUED DATE: | 2017.01.03 |
| DESCRIPTION : | I.T.E. POWER SUPPLY | REV: | (A0) |

17. PACKING

17.2 Carton

UNIT: mm

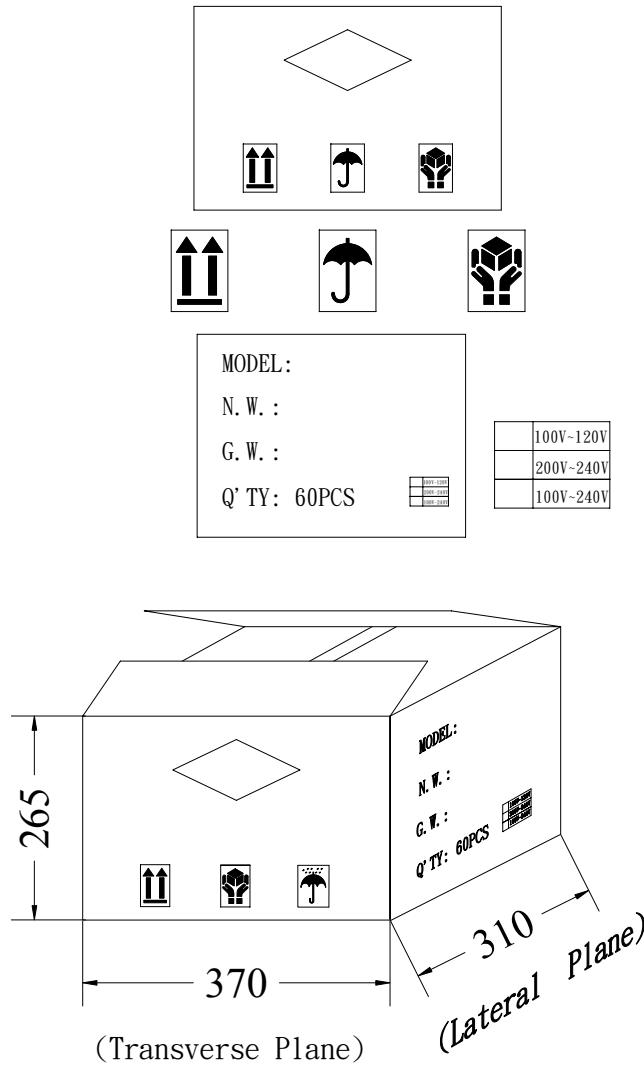

| | | | |
|---------------|---------------------|--------------|------------|
| MODEL NO. : | HK-AY-240A100-CP | PAGE NO. : | 12 OF 13 |
| PART NO. : | HKSC-170003 | ISSUED DATE: | 2017.01.03 |
| DESCRIPTION : | I.T.E. POWER SUPPLY | REV: | (A0) |

18. MARKING

100# CPC 壓花底+上光 NAME-PLATE:WHITE CHARACTERS BLACK BACKGROUND.

UNIT: mm MMYYC

month year
 made in China
 by Hon-kwang

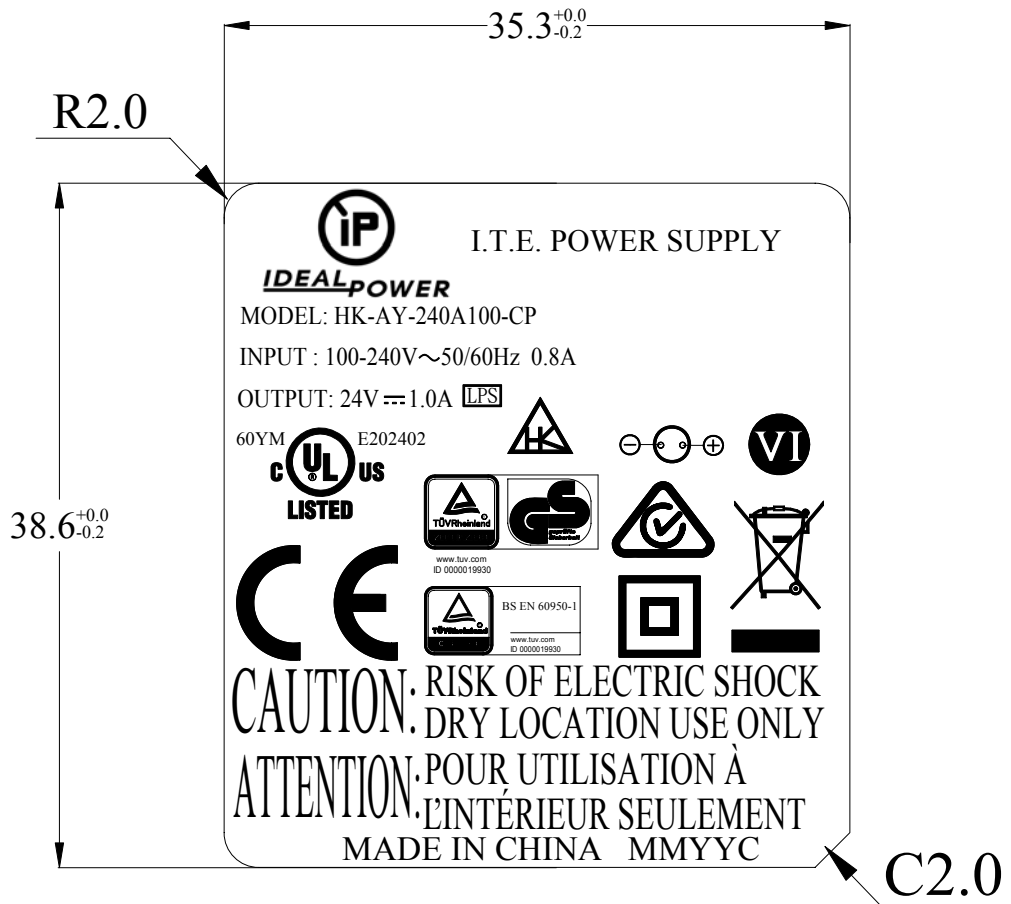

X-ON Electronics

Largest Supplier of Electrical and Electronic Components

Click to view similar products for [Ideal manufacturer](#):

Other Similar products are found below :

[30-582](#) [VDV II PLUS](#) [45-915](#) [45-173](#) [45-098](#) [45-097](#) [L-5361](#) [45-093](#) [45-162](#) [41-990](#) [15DYS618-120150W-3](#) [15DYS624-050400W-K](#) [30-503](#) [35-020](#) [35-060](#) [35-516](#) [45-120](#) [45-1633-1](#) [45-170](#) [45-176](#) [45-1773-1](#) [45-1774](#) [45-1939-1](#) [45-2133-1](#) [45-298](#) [45-372](#) [45-404](#) [K-6336](#) [K-8906R](#) [L-4866](#) [L-9038](#) [LB-1091](#) [35-522](#) [61-775](#) [KB-0276R](#) [25HK-AB-050A400-CP](#) [30-593](#) [30-696](#) [33-856](#) [158050](#) [30-576](#) [45-672](#) [45-292](#) [45-129](#) [LB-1002](#) [30-793](#) [33-864](#) [45-1611-1](#) [R151005](#) [45-1513](#)