

56 mm sq.

1.8° /step RoHS

Unipolar and Bipolar winding
Lead wire type

Based motor	Holding torque at 2-phase energization [N.m min.]	Step angle °	Winding type	Rated current A/phase	Wiring resistance Ω /phase	Winding inductance mH/phase	Rotor Inertia [x 10 ⁻⁴ kg.m ²]	Weight kg	Optional motor cable
2H5654U10	0.83	1.8	Unipolar	1	6.7	15	0.21	0.65	-
2H5654U20	0.83	1.8	Unipolar	2	1.6	3.8	0.21	0.65	-
2H5654B20	0.83	1.8	Bipolar	2	0.8	3.8	0.21	0.65	-
2H5676B20	1.27	1.8	Bipolar	2	1.05	4.5	0.36	0.98	-
2H5695B20	2	1.8	Bipolar	2	2.3	10.4	0.49	1.3	-

Dynamic performances

2H5654U10

Driver: Internal circuit
Power supply: — 36V — 24V
Current: 1A/phase unipolar
Excitation mode: Full-step
Load inertia JL = 2.6x10⁻⁴kg.m² (rubber coupling)

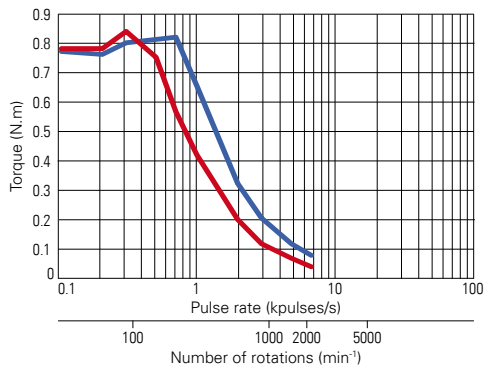

2H5654U20

Driver: US1D200P10
Power supply: — 36V — 24V
Current: 2A/phase bipolar
Excitation mode: Full-step
Load inertia JL = 0.94x10⁻⁴kg.m² (rubber coupling)

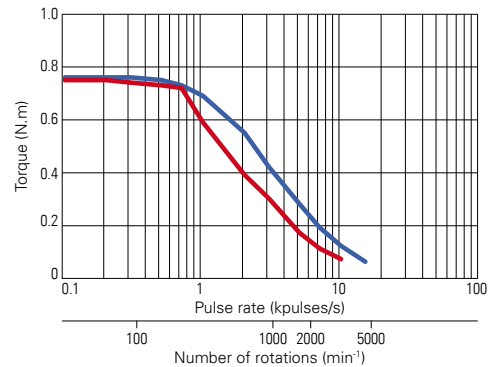

2H5654B20

Driver: BS1D200P10
Power supply: — 36VDC — 24VDC
Current: 2A/phase bipolar
Excitation mode: Full-step
Load inertia JL = 2.6x10⁻⁴kg.m² (rubber coupling)

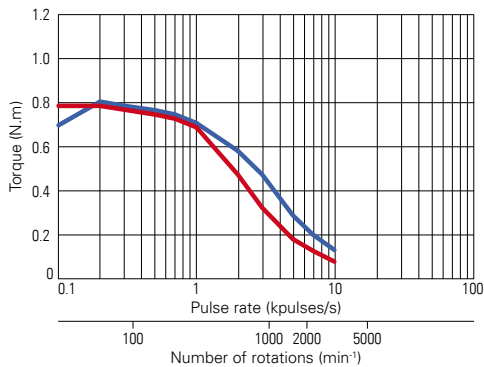

2H5676B20

Driver: BS1D200P10
Power supply: — 36VDC — 24VDC
Current: 2A/phase bipolar
Excitation mode: Full-step
Load inertia JL = 2.6x10⁻⁴kg.m² (rubber coupling)

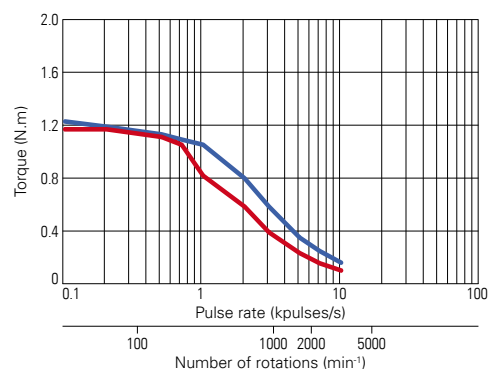

35mm sq.

42mm sq.

56mm sq.

60mm sq.

86mm sq.

Encoder Specifications

Customization Service

2H5695B20

Driver: Internal circuit
 Power supply: — 36V — 24V
 Current: 2A/phase bipolar
 Excitation mode: Full-step
 Load inertia $J_L = 7.4 \times 10^{-4} \text{ kg.m}^2$ (rubber coupling)

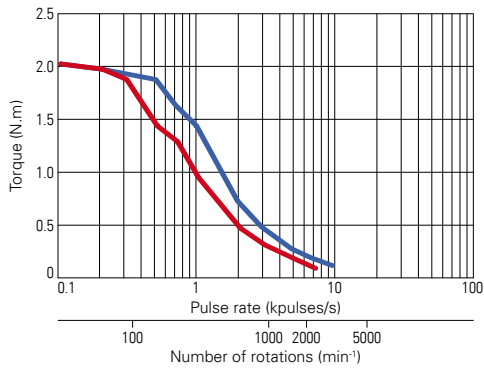

Dimensions [Unit: mm]

2H5654xxxR220

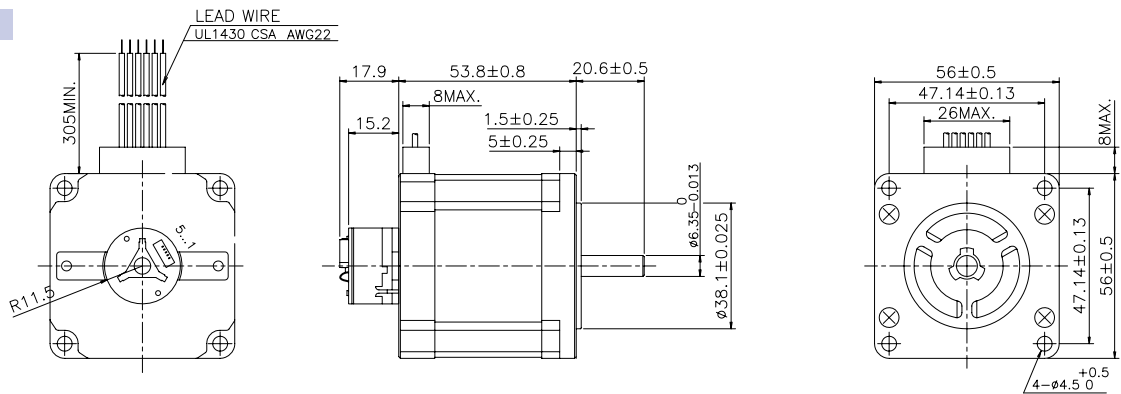

2H5695B20R220

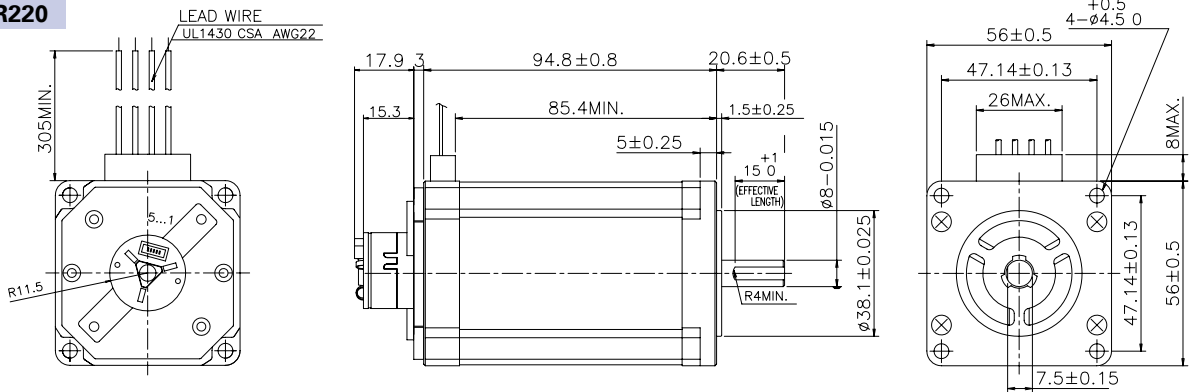

2H56xxxxSx40 2H56xxxxM21x

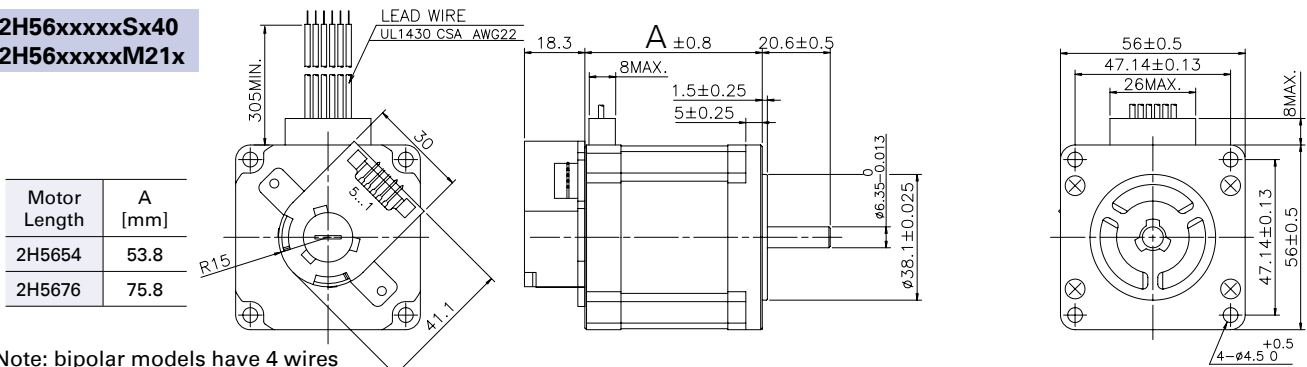

Note: bipolar models have 4 wires

2H5695B20Sx40
2H5695B20M21x

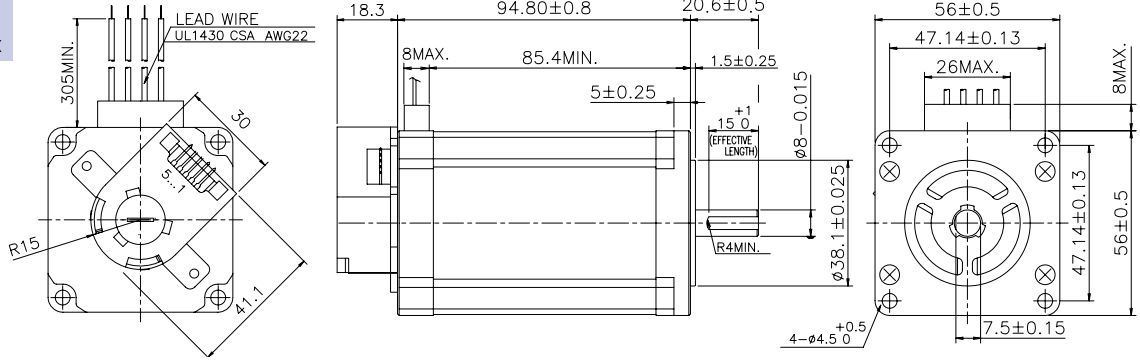

2H56xxxxxL240

Motor Length	A [mm]
2H5654	53.8
2H5676	75.8

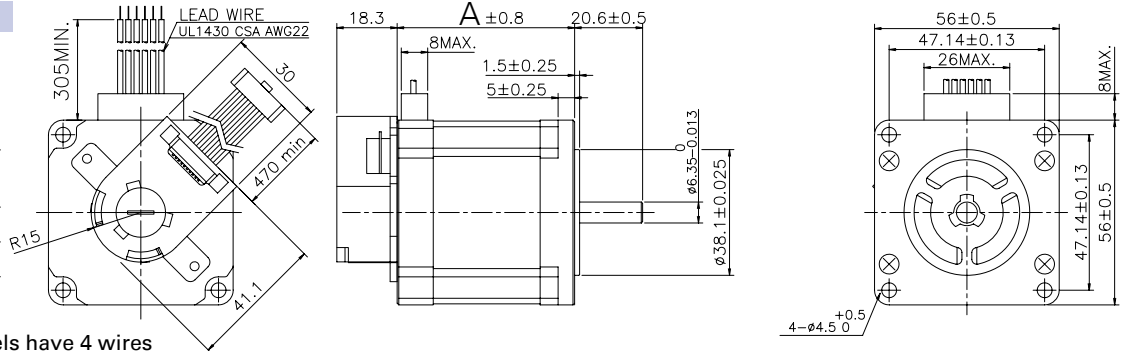

Note: bipolar models have 4 wires

2H5695B20L240

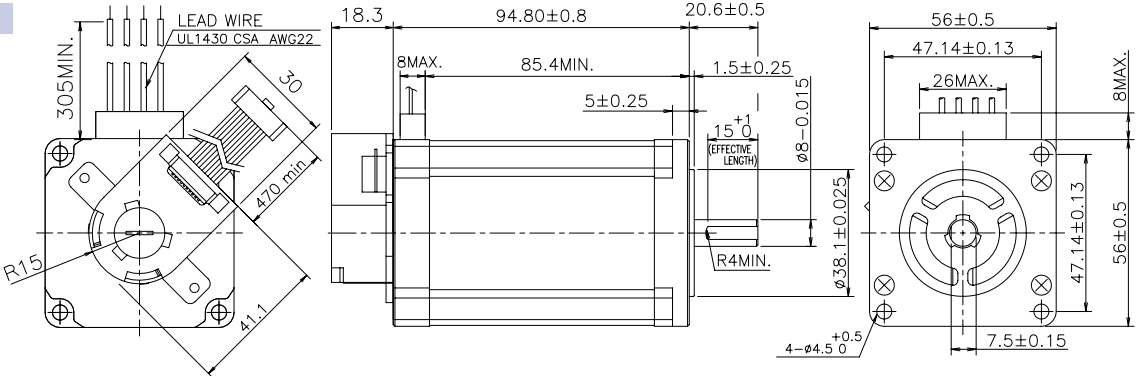

Internal wiring

Unipolar winding

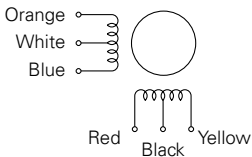

Bipolar winding

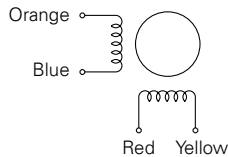

General Specification ▶ p. 24
Rotation Direction ▶ p. 25

Encoder cables

R220 Encoder, Cable P/N: CRS22500

Manufacturer: MOLEX
Housing: 51021-0500
Terminal: 50079-8000 or 8100

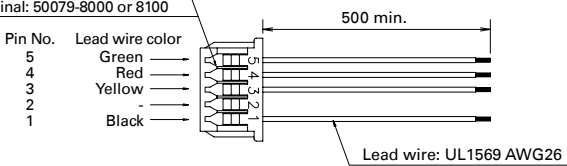

S340 Encoder, Cable P/N: CS3500

Manufacturer: MOLEX
Housing: 22-01-2055
(locking ramp cut)

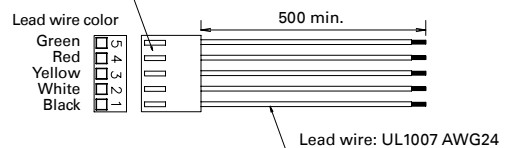

S240, M21x Encoder, Cable P/N: CS2500

Manufacturer: MOLEX
Housing: 22-01-2055
(locking ramp cut)

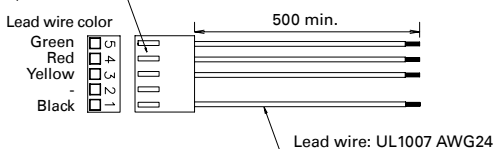

35mm sq.

42mm sq.

56mm sq.

60mm sq.

86mm sq.

Encoder Specifications

Customization Service



S type Encoder

RoHS

- Two channel quadrature outputs with optional index pulse
- Resolution 400 or 500 counts per revolution
- Single ended output signals, TTL compatible
- Single 5VDC supply
- HEDS serie encoders from Broadcom Limited

Encoder features

Parameter	S240	S340
Supply voltage [VDC]	5 ± 0.5	
Max. Supply current [mA]	40	85
Output voltage [VDC]	VOH = 2.4 min, VOL = 0.4 max	
Output channels	2 (A, B)	3 (A, B, I)
Maximum frequency [kHz]	100	

Encoder pin-outs

Pins	S240	S340
Pin 1	GND	
Pin 2	NC	Channel I
Pin 3	Channel A	
Pin 4	5 VDC	
Pin 5	Channel B	

Encoder P/N

S240: 2 channels, 400CPR
S340: 3 channels, 400CPR

Output waveforms

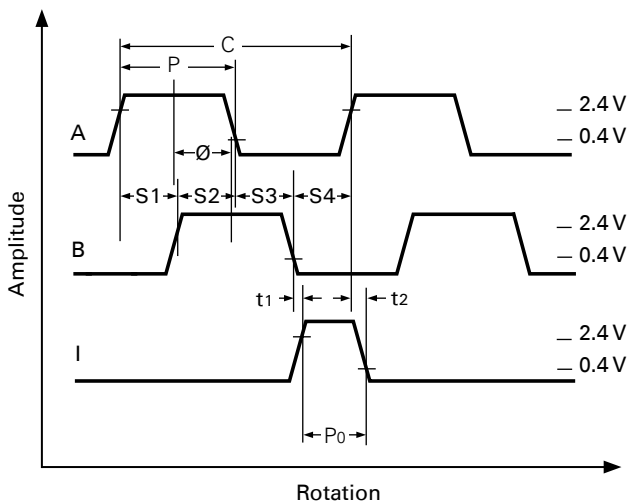

Encoding characteristics

Parameter	Symbol	S240			S340		
		Min.	Typ.*	Max.	Min.	Typ.*	Max.
Pulse width error [°e]	ΔP	7	45		5	45	
Logic width error [°e]	ΔS	5	45		5	35	
Phase error [°e]	Δθ	2	20		2	15	
Position error [arcmin.]	Δθ	10	40		10	40	
Cycle error [°e]	ΔC	3	5.5		3	5.5	
Index pulse width [°e]	P0				55	125	
CH.I rise after CH.A or CH.B fall [ns]	t1				-300	250	
CH.I fall after CH.A or CH.B rise [ns]	t2				70	1000	

*Typical values specified at supply voltage = 5.0 VDC and 25°C

Electrical interface

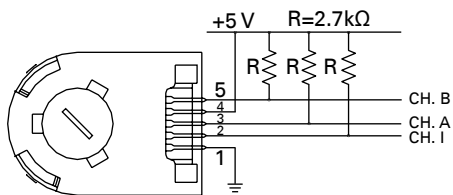

S340 encoders require 2.7kΩ (±10%) pull-up resistors on output pins 2,3 and 5 (Channels I, A and B). These pull-up resistors should be located as close to the encoder as possible.

S240 encoders do not normally require pull-up resistors. However, 3.2kΩ pull-up resistors on output pins 3 and 5 (Channels A and B) are recommended.

Suitable connectors

Manufacturer	Part number	
	Housing	Contact
AMP	103686-4	640442-5
Molex	2695 series	2759 series
FCI	65039-032	4825X-000

Encoder cables

S240 Encoder, Cable P/N: CS2500

Manufacturer: MOLEX
Housing: 22-01-2055
(locking ramp cut)

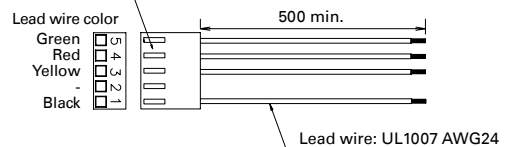

S340 Encoder, Cable P/N: CS3500

Manufacturer: MOLEX
Housing: 22-01-2055
(locking ramp cut)

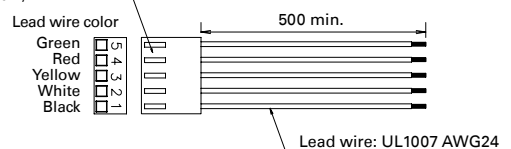

35mm sq.

42mm sq.

56mm sq.

60mm sq.

86mm sq.

Encoder Specifications

Customization Service

STEPPING MOTOR WITH ENCODER

When open-loop control is not enough

Stepping systems provide precise positioning with easy control. By adding an encoder to a stepping motor, the controller can monitor the actual position directly, closing the feedback loop and improving the safety and reliability.

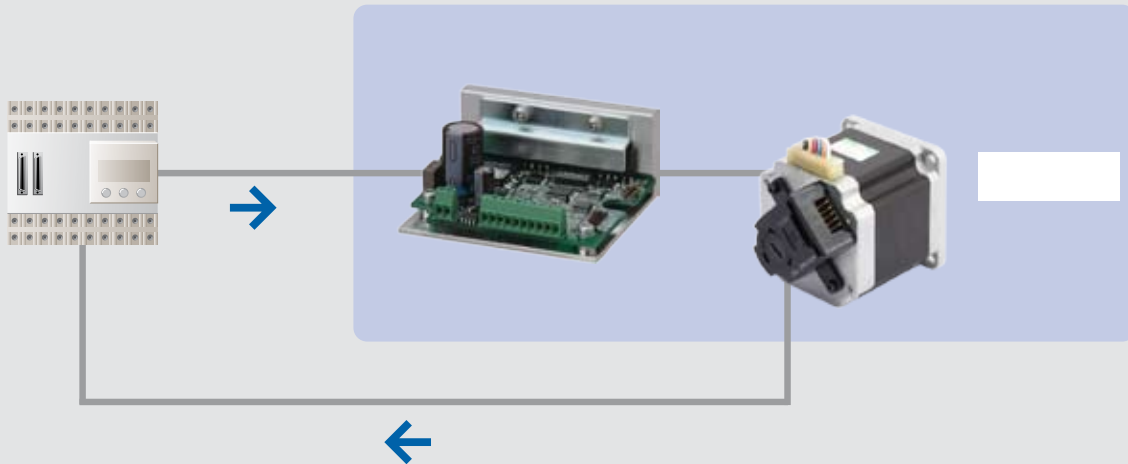

Stepping Motor with Encoder: Features

Safety: Position verification

Adding an encoder is an ideal and easy solution for safety-sensitive applications, requiring position verification and position maintenance, such as medical instrumentation.

Close-loop control with stepper benefit

High-end close loop control can be achieved while keeping the advantages of stepping motors: stable stop without hunting, higher torque than DC servo motor at low speed over the same size, eliminating the need of gearboxes.

Reliability: Stall Detection

Device reliability is improved with possible detection and reporting of stalls.

Accurate Homing

Encoder with index pulse option can be used to achieve precise homing.



We also provide quick customization service to meet your particular need. Contact our sales office for information.

Application Examples



Blood Analyser

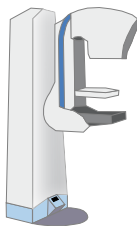

Mammograph









3D Printing







Industrial machine

Stepping Motors: Lineup RoHS

Basic step angle	Motor size		Holding torque [Nm min.] Model number	Page
1.8°	35 mm sq.		0.195 to 0.23 2H35□	p. 8
0.9°	42 mm sq.		0.23 2P42□	p. 10
1.8°	42 mm sq.		0.26 to 0.42 2H42□	p. 10
1.8°	56 mm sq.		0.83 to 2 2H56□	p. 13
1.8°	60 mm sq.		0.88 to 2.7 2H60□	p. 16
1.8°	86 mm sq.		3.3 to 9 2H86□	p. 18

Encoder Selection Guide RoHS

4 types of encoder can be selected. They are two and three channels optical incremental encoders and emphasize high reliability and high resolution.

Encoder type		Counts Per Revolution [CPR]				Pulse index option	Single ended	Differential line driver	Key points
		200	400	1000	1024				
R _{type}		■					■		Compact size Simple interface Cost effective
S _{type}			■			■	■		Medium resolution Pulse index option Simple interface
M _{type}				■	■	■	■		High resolution Pulse index option Simple interface
L _{type}			■					■	Noise immunity Transmitting encoder signal over a long distance

Encoder specifications ▶ p. 20 to 23
Please consult us for higher resolution encoder

How to Read Part Numbers

Note that not every combination of the following codes or characters is available. Check the part numbers available on the following or contact us.

Example: This is a standard model number for a stepping motor and encoder. The motor specifications are 2-phase stepping motor, motor size: 56mm sq., motor length: 54mm, bipolar winding, 2A/phase, S type encoder, 2 channels, 400 CPR.

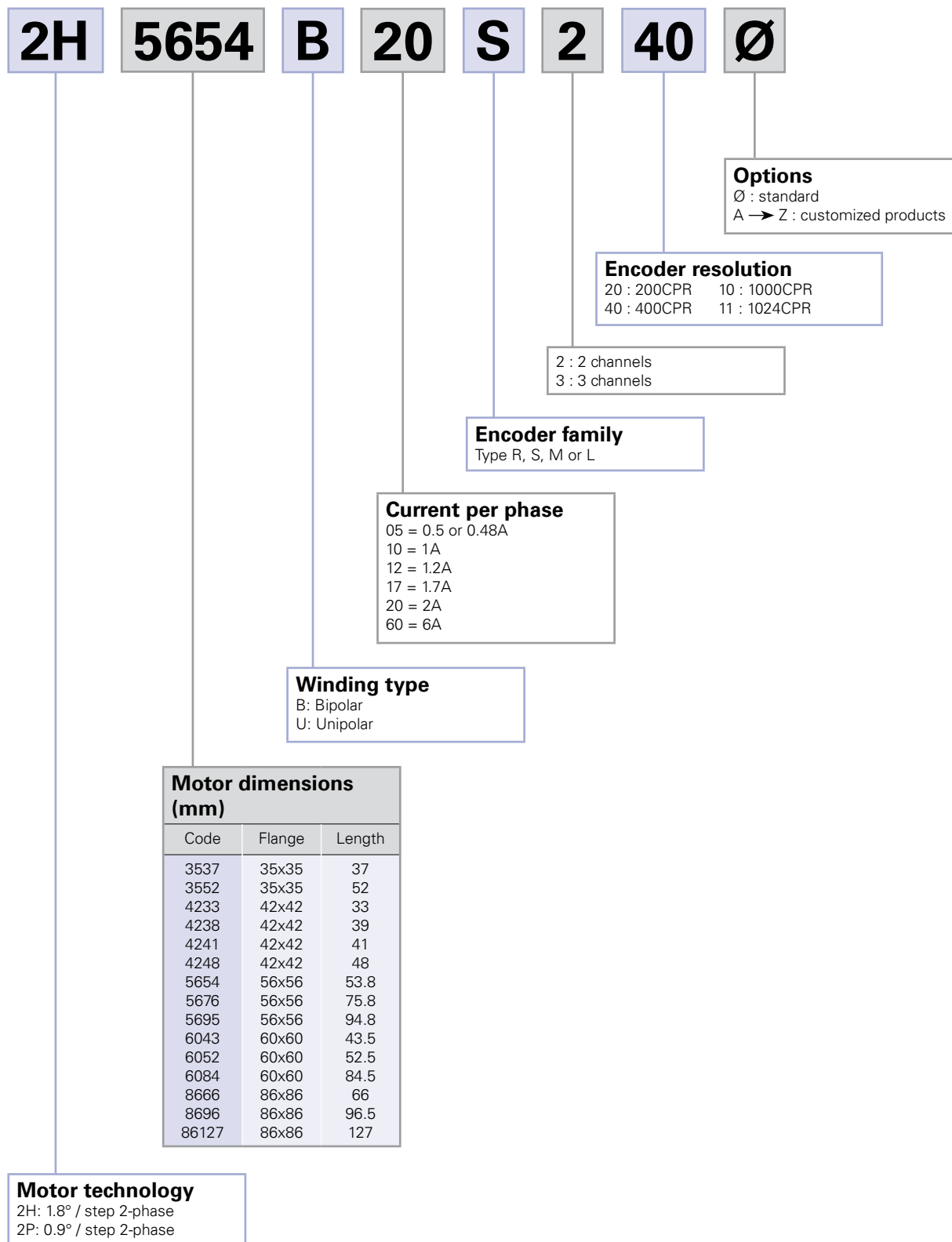

Part Numbers Available

On above table are introduced available combinations between stepping motors and encoders.

■ : Valid combinations, available from stock

Motor size	Based motor	Encoder type							
		R type	S type			M type			L type
		2 channels	2 channels	3 channels	2 channels		3 channels	2 channels	
		200CPR	400CPR	400CPR	1000CPR	1024CPR	1000CPR	400CPR	
		R220	S240	S340	M210	M211	M310	L240	
35 mm sq.	2H3537B12	■	■	■	■	■	■		
	2H3552U12	■	■	■	■	■	■		
42 mm sq.	2P4233B10		■	■	■	■	■		
	2H4233B05	■	■	■	■	■	■		
	2H4238B17	■	■	■	■	■	■		
	2H4241B05		■	■	■	■	■		
	2H4241U12		■	■	■	■	■		
	2H4248U12	■	■	■	■	■	■		
56 mm sq.	2H5654U10	■	■	■	■	■		■	
	2H5654U20	■	■	■	■	■		■	
	2H5654B20		■	■	■	■		■	
	2H5676B20		■	■	■	■		■	
	2H5695B20	■	■	■	■	■		■	
60 mm sq.	2H6043B20	■	■	■	■	■		■	
	2H6052B20	■	■	■	■	■		■	
	2H6084B20	■	■	■	■	■		■	
86 mm sq.	2H8666B60	■	■	■	■	■		■	
	2H8696B60	■	■	■	■	■		■	
	2H86127B60	■	■	■	■	■		■	

Optional Cables

Motor cables

Motor size	Based motor	Cable P/N
42 mm sq.	2H4233B05	4835728-1
	2H4238B17	4835728-1
	2H4241B05	4835728-1
	2H4241U12	4835710-1
	2H4248U12	4835710-1

Encoder cables

Encoder	Motor type	Cable P/N
R220	2H35, 2H42	CRP12500
	2H56, 2H60, 2H86	CRS22500
S240 M21x	all	CS2500
S340 M310	all	CS3500

X-ON Electronics

Largest Supplier of Electrical and Electronic Components

Click to view similar products for [Sanyo Denki](#) manufacturer:

Other Similar products are found below :

[9A0824H401](#) [9G1212E401](#) [9GA0812P1H61](#) [9GA0812P1S61](#) [9GV1512H501](#) [9S1212H401](#) [SM2861-5255](#) [9G1212F101](#) [9G1212M101](#)
[9GV1248P1J01](#) [9HV0412P3K001](#) [9WE1724K501](#) [9WG1212E101](#) [103H5208-5240](#) [103H7126-5840](#) [103H7822-5740](#) [109-1001F13](#) [109-1002F40](#) [109-1003M30](#) [109-313](#) [109-601](#) [109L1748H501](#) [109L5712H501](#) [109P0412D602](#) [109P0424G302](#) [109P1412M101](#)
[109R0824S4D01](#) [109-1069](#) [109-604](#) [109BF24HD2](#) [109P0424H302](#) [9L0412H301](#) [103H8223-6340](#) [103H8222-5141](#) [9S1212L4011](#)
[9LG0612P4S001](#) [9GA0812P1H611](#) [9A0824S402](#) [109-049C](#) [103H89223-6341](#) [SM2863-5155](#) [9G1248G4D011](#) [9G1224M4D011](#)
[109P0624W602](#) [9WF0924S201](#) [9A0812S402](#) [109E1724M501](#) [9GV1248P4J011](#) [9G1224F102](#) [109R0648S402](#)