

Identification

Type Designation	LR3 48-5/40	Type of reactor	3~ Line Reactor
Series	LR3	Core Rating	1664.79 var
Core type	3UI 90/41.5	Drive HP	30

Technical Data

No. of phase		3
Circuit type		III0
Rated Voltage	[V]	480
Rated current	[A]	40.0
Rated Frequency	[Hz]	50 - 60
Impedance	[%]	5.0
Inductance L	[mH]	0.920
L tolerance	[%]	±10%
Linearity		150% In
Losses (typical)	[W]	78.50
Test voltage	[kV]	4.0
Isolation System Class		class 155

Operating conditions

Ambient temperature	[°C]	-10 ... +40°C
Ambient temperature	[F]	14 ... 104°F
Type of cooling		AN
Operating conditions		24/7

Standards

Type:	Signs
VDE 0570 / EN 61 558 Part 1 VDE 0570 / EN 61 558 Part 20	

Approvals

UL 508		E219022	NMTR
UL 5085-1		E103521	XPTQ

Product Ident
LR3 48-5/40

Line-Reactor Datasheet



Variations may apply due to material's and production's tolerances. Objected to modifications without notice.

Dimensions / Mounting in Inches

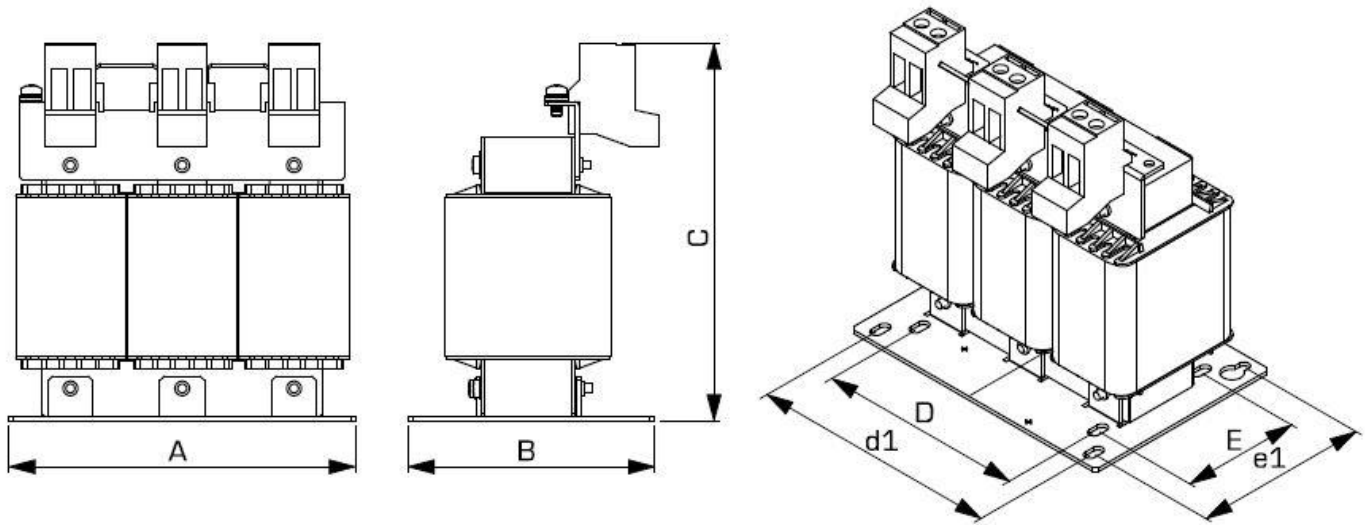

A	B	C*	F	D	d1	d2	E	e1	e2	Drill
7.28	4.41	7.76	-	3.54	5.35	6.70	3.66	3.15	2.60	0.31
										0.28
										0.31

* = Typical variable air gab

Weight

Weight	[kg]	8.68
	[lbs]	19.13

Notes

Technical specifications in the drawing are not binding. General tolerance to DIN 7168-m. Subject to change.
Mounting plates also available in stainless steel as OEM application. Ask for details.

Original Date:	15/04/20	Observe protection clause to ISO 16016	Index	0
Name:	Lüning		Doc. type	
Date:	15/05/06			
Checked:	Wesner		Pages	2 of 2

X-ON Electronics

Largest Supplier of Electrical and Electronic Components

Click to view similar products for [Block manufacturer](#):

Other Similar products are found below :

[PVSB 400/24-20](#) [RKD 40/2X18](#) [RKD 120/2X24](#) [AVB1.0/2/12](#) [FL52/24](#) [FL6/24](#) [AVB0.5/2/6](#) [AVB2.3/2/6](#) [STEU63/23](#) [VB 0.35/1/15](#) [LR3 48-3/80](#) [LR3 48-5/70](#) [LR3 60-3/70](#) [PC-0148-100-0](#) [PC-0324-100-0](#) [PM-0748-400-0](#) [EB-2724-060-0](#) [PVUA 24/24-20](#) [RKD 100/2X24](#) [VB1.5/2/24](#) [FL4/18](#) [TIM500](#) [VB2.3/2/9](#) [AVB3.2/2/6](#) [STEU320/23](#) [STEU100/24](#) [VB 1.5/2/8](#) [SAT600](#) [LR3 48-5/80](#) [LR3 48-5/90](#) [PM-0124-020-0](#) [PM-0148-020-0](#) [PM-0724-120-0](#) [EB-1824-010-0](#) [STEU160/48](#) [FL10/24](#) [FL14/18](#) [SAT200](#) [DCT24-1.5](#) [FL18/6](#) [FL24/6](#) [VB2.3/2/24](#) [VB2.8/2/15](#) [LR3 48-5/16](#) [PM-0112-040-0](#) [PM-0112-070-0](#) [STEU63/24](#) [FL18/12](#) [FL24/24](#) [STEU250/24](#)