

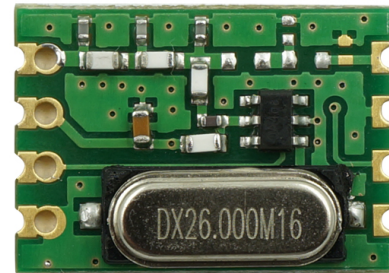
## Features

- Embedded EEPROM
  - Very Easy Development with RFPDK
  - All Features Programmable
- Frequency Range: 240 to 960 MHz
- FSK, GFSK and OOK Modulation
- Symbol Rate:
  - 0.5 to 100 ksps (FSK/GFSK)
  - 0.5 to 30 ksps (OOK)
- Deviation: 1.0 to 200 kHz
- Two-wire Interface for Registers Accessing and EEPROM Programming
- Output Power: -10 to +13 dBm
- Supply Voltage: 1.8 to 3.6 V
- Sleep Current: < 20 nA
- FCC/ETSI Compliant
- RoHS Compliant
- Module Size: 17.8\*12.8\*5.0mm (RFM119W)  
16\*16\*5.0mm (RFM119SW)

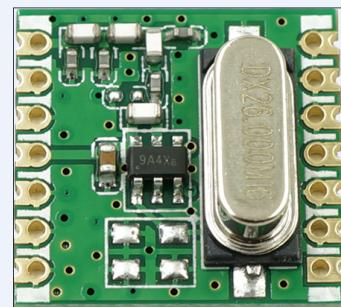
## Descriptions

The RFM119W/RFM119SW is a high performance, highly flexible, low-cost, single-chip (G)FSK/OOK transmitter for various, 240 to 960 MHz wireless applications. It is a part of the HOPERF NextGenRF™ family, which includes a complete line of transmitters, receivers and transceivers. The RFM119W/RFM119SW provides the simplest way to control the data transmission. The transmission is started when an effective level turnover is detected on the DATA pin, while the transmission action will stop after the DATA pin holding level low for a defined time window, or after a two-wire interface (TWI) command is issued. The chip features can be configured in two different ways: setting the configuration registers through the TWI, or programming the embedded

RFPDK. The device operates from a supply voltage of 1.8 V to 3.6 V, consumes 27.6 mA (FSK @ 868.35 MHz) when transmitting +10 dBm output power, and only leak 20 nA when it is in sleep state. The RFM119W/RFM119SW transmitter together with the CMT2219A receiver enables a robust RF link.



**RFM119W**



**RFM119SW**

## Applications

- Low-Cost Consumer Electronics Applications
- Home and Building Automation
- Remote Fan Controllers
- Infrared Transmitter Replacements
- Industrial Monitoring and Controls
- Remote Lighting Control
- Wireless Alarm and Security Systems
- Remote Keyless Entry (RKE)

## Abbreviations

Abbreviations used in this data sheet are described below

<b>AN</b>	Application Notes	<b>PA</b>	Power Amplifier
<b>BOM</b>	Bill of Materials	<b>PC</b>	Personal Computer
<b>BSC</b>	Basic Spacing between Centers	<b>PCB</b>	Printed Circuit Board
<b>EEPROM</b>	Electrically Erasable Programmable Read-Only Memory	<b>PN</b>	Phase Noise
<b>ESD</b>	Electro-Static Discharge	<b>RCLK</b>	Reference Clock
<b>ESR</b>	Equivalent Series Resistance	<b>RF</b>	Radio Frequency
<b>ETSI</b>	European Telecommunications Standards Institute	<b>RFPDK</b>	RF Product Development Kit
<b>FCC</b>	Federal Communications Commission	<b>RoHS</b>	Restriction of Hazardous Substances
<b>FSK</b>	Frequency Shift Keying	<b>Rx</b>	Receiving, Receiver
<b>GFSK</b>	Gauss Frequency Shift Keying	<b>SOT</b>	Small-Outline Transistor
<b>Max</b>	Maximum	<b>SR</b>	Symbol Rate
<b>MCU</b>	Microcontroller Unit	<b>TWI</b>	Two-wire Interface
<b>Min</b>	Minimum	<b>Tx</b>	Transmission, Transmitter
<b>MOQ</b>	Minimum Order Quantity	<b>Typ</b>	Typical
<b>NP0</b>	Negative-Positive-Zero	<b>USB</b>	Universal Serial Bus
<b>OBW</b>	Occupied Bandwidth	<b>XO/XOSC</b>	Crystal Oscillator
<b>OOK</b>	On-Off Keying	<b>XTAL</b>	Crystal
		<b>PA</b>	Power Amplifier

**Table of Contents**

<b>1. Electrical Characteristics</b> .....	<b>4</b>
1.1 Recommended Operating Conditions .....	4
1.2 Absolute Maximum Ratings.....	4
1.3 Transmitter Specifications .....	5
<b>2. Pin Descriptions</b> .....	<b>6</b>
<b>3. Typical Performance Characteristics</b> .....	<b>7</b>
<b>4. Typical Application Schematics</b> .....	<b>8</b>
<b>5. Functional Descriptions</b> .....	<b>9</b>
5.1 Overview .....	9
5.2 Modulation, Frequency, Deviation and Symbol Rate .....	9
5.3 Embedded EEPROM and RFPDK .....	10
5.4 Power Amplifier .....	11
5.5 PA Ramping .....	12
5.6 Working States and Transmission Control Interface .....	13
5.6.1 Working States .....	14
5.6.2 Transmission Control Interface .....	14
5.6.2.1 Tx Enabled by DATA Pin Rising Edge.....	14
5.6.2.2 Tx Enabled by DATA Pin Falling Edge .....	14
5.6.2.3 Two-wire Interface .....	14
<b>6. Ordering Information</b> .....	<b>17</b>
<b>7. Package Outline</b> .....	<b>18</b>
<b>8. Contact Information</b> .....	<b>19</b>

## 1. Electrical Characteristics

$V_{DD} = 3.3\text{ V}$ ,  $T_{OP} = 25\text{ }^{\circ}\text{C}$ ,  $F_{RF} = 868.35\text{ MHz}$ , FSK modulation, output power is +10 dBm terminated in a matched 50  $\Omega$  impedance, unless otherwise noted.

### 1.1 Recommended Operating Conditions

**Table 2. Recommended Operation Conditions**

Parameter	Symbol	Conditions	Min	Typ	Max	Unit
Operation Voltage Supply	$V_{DD}$		1.8		3.6	V
Operation Temperature	$T_{OP}$		-40		85	$^{\circ}\text{C}$
Supply Voltage Slew Rate			1			mV/us

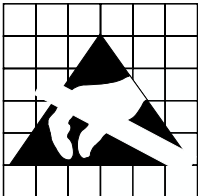
### 1.2 Absolute Maximum Ratings

**Table 3. Absolute Maximum Ratings<sup>[1]</sup>**

Parameter	Symbol	Conditions	Min	Max	Unit
Supply Voltage	$V_{DD}$		-0.3	3.6	V
Interface Voltage	$V_{IN}$		-0.3	$V_{DD} + 0.3$	V
Junction Temperature	$T_J$		-40	125	$^{\circ}\text{C}$
Storage Temperature	$T_{STG}$		-50	150	$^{\circ}\text{C}$
Soldering Temperature	$T_{SDR}$	Lasts at least 30 seconds		255	$^{\circ}\text{C}$
ESD Rating		Human Body Model (HBM)	-2	2	kV
Latch-up Current		@ 85 $^{\circ}\text{C}$	-100	100	mA

**Note:**

[1]. Stresses above those listed as “absolute maximum ratings” may cause permanent damage to the device. This is a stress rating only and functional operation of the device under these conditions is not implied. Exposure to maximum rating conditions for extended periods may affect device reliability.



**Caution!** ESD sensitive device. Precaution should be used when handling the device in order to prevent permanent damage.

## 1.3 Transmitter Specifications

**Table 4. Transmitter Specifications**

Parameter	Symbol	Conditions	Min	Typ	Max	Unit
Frequency Range <sup>[1]</sup>	$F_{RF}$		240		960	MHz
Synthesizer Frequency Resolution	$F_{RES}$	$F_{RF} \leq 480$ MHz		198		Hz
		$F_{RF} > 480$ MHz		397		Hz
Symbol Rate	SR	FSK/GFSK	0.5		100	ksps
		OOK	0.5		30	ksps
(G)FSK Modulation Deviation Range	$F_{DEV}$		1		200	kHz
Bandwidth-Time Product	BT	GFSK modulation	-	0.5	-	-
Maximum Output Power	$P_{OUT(Max)}$			+13		dBm
Minimum Output Power	$P_{OUT(Min)}$			-10		dBm
Output Power Step Size	$P_{STEP}$			1		dB
OOK PA Ramping Time <sup>[2]</sup>	$t_{RAMP}$		0		1024	us
Current Consumption @ 433.92 MHz	$I_{DD-433.92}$	OOK, 0 dBm, 50% duty cycle		6.7		mA
		OOK, +10 dBm, 50% duty cycle		13.4		mA
		OOK, +13 dBm, 50% duty cycle		17.4		mA
		FSK, 0 dBm, 9.6 ksps		10.5		mA
		FSK, +10 dBm, 9.6 ksps		23.5		mA
		FSK, +13 dBm, 9.6 ksps		32.5		mA
Current Consumption @ 868.35 MHz	$I_{DD-868.35}$	OOK, 0 dBm, 50% duty cycle		8.0		mA
		OOK, +10 dBm, 50% duty cycle		15.5		mA
		OOK, +13 dBm, 50% duty cycle		19.9		mA
		FSK, 0 dBm, 9.6 ksps		12.3		mA
		FSK, +10 dBm, 9.6 ksps		27.6		mA
		FSK, +13 dBm, 9.6 ksps		36.1		mA
Sleep Current	$I_{SLEEP}$			20		nA
Frequency Tune Time	$t_{TUNE}$			370		us
Phase Noise @ 433.92 MHz	PN <sub>433.92</sub>	100 kHz offset from $F_{RF}$		-80		dBc/Hz
		600 kHz offset from $F_{RF}$		-98		dBc/Hz
		1.2 MHz offset from $F_{RF}$		-107		dBc/Hz
Phase Noise @ 868.35 MHz	PN <sub>868.35</sub>	100 kHz offset from $F_{RF}$		-74		dBc/Hz
		600 kHz offset from $F_{RF}$		-92		dBc/Hz
		1.2 MHz offset from $F_{RF}$		-101		dBc/Hz
Harmonics Output for 433.92 MHz <sup>[3]</sup>	H2 <sub>433.92</sub>	2 <sup>nd</sup> harm @ 867.84 MHz, +13 dBm $P_{OUT}$		-52		dBm
	H3 <sub>433.92</sub>	3 <sup>rd</sup> harm @ 1301.76 MHz, +13 dBm $P_{OUT}$		-60		dBm
Harmonics Output for 868.35 MHz <sup>[3]</sup>	H2 <sub>868.35</sub>	2 <sup>nd</sup> harm @ 1736.7 MHz, +13 dBm $P_{OUT}$		-67		dBm
	H3 <sub>868.35</sub>	3 <sup>rd</sup> harm @ 2605.05 MHz, +13 dBm $P_{OUT}$		-55		dBm
OOK Extinction Ratio				60		dB

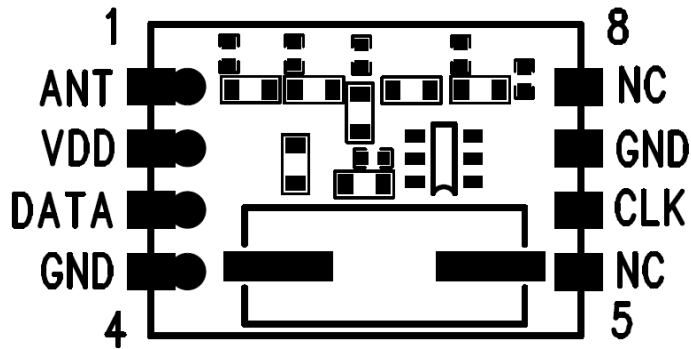
**Notes:**

[1]. The frequency range is continuous over the specified range.

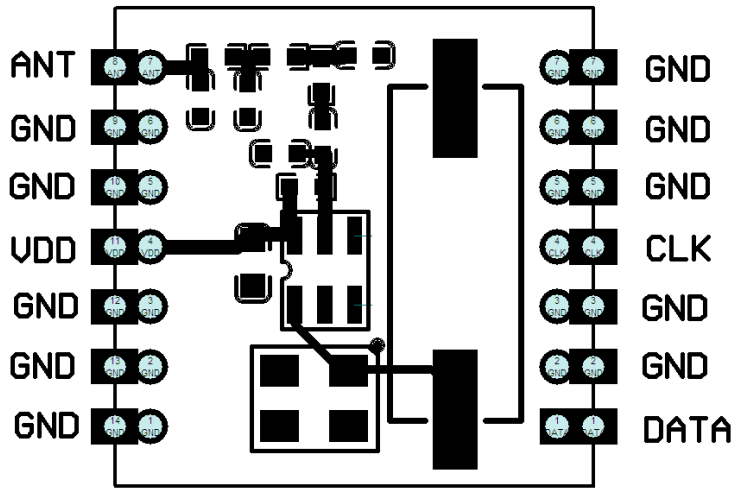
[2]. 0 and 2<sup>n</sup> us, n = 0 to 10, when set to "0", the PA output power will ramp to its configured value in the shortest possible time.

[3]. The harmonics output is measured with the application shown as Figure 10.

**2. Pin Descriptions**



RFM119W. Pin Diagram

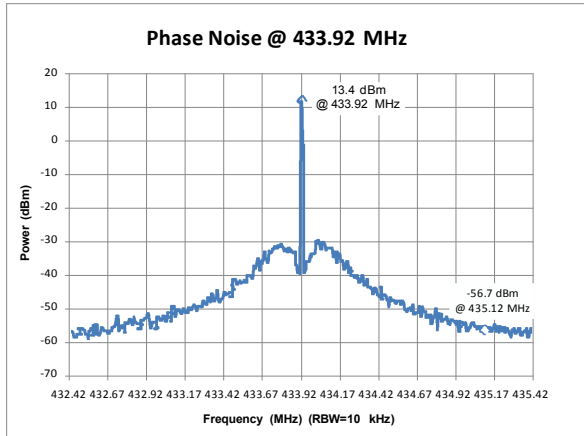


RFM119SW. Pin Diagram

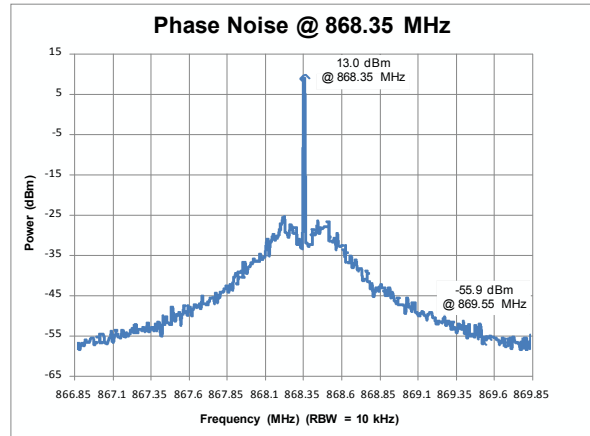
**Table 6. RFM119W/RFM119SW Pin Descriptions**

Pin Number		Name	I/O	Descriptions
RFM119W	RFM119SW			
1	1	ANT	O	Transmitter RF Output
2	4	VDD	I	Power Supply 1.8V to 3.6V
3	8	DATA	I/O	Data input to be transmitted or Data pin to access the embedded EEPROM
4	2,7,9,14	GND	I	Ground
5	3,5,6,	NC	---	Connect to GND
6	11	CLK	I	Clock pin to access the embedded EEPROM
7		GND	I	Ground
8	10,12,13	NC	---	Connect to GND

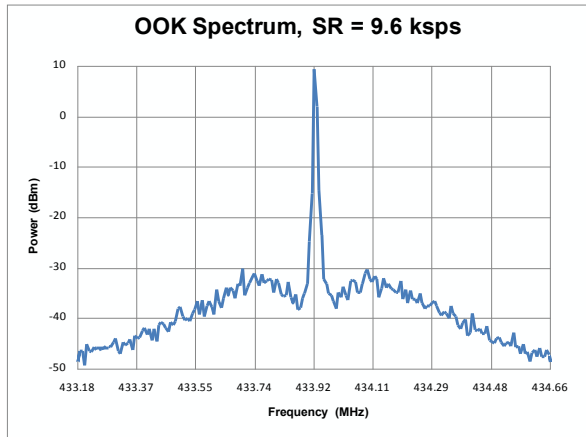
### 3. Typical Performance Characteristics



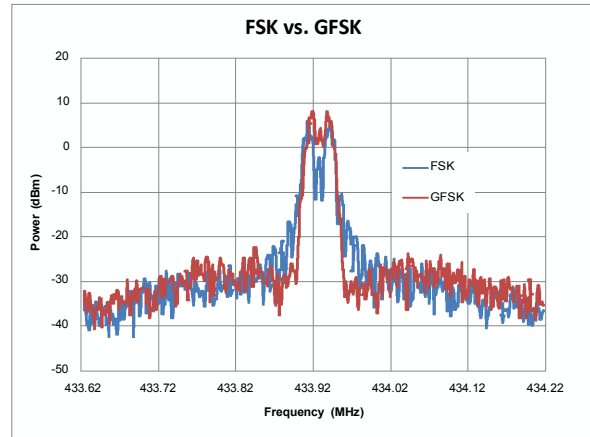
**Figure 3. Phase Noise,  $F_{RF} = 433.92$  MHz,  
 $P_{OUT} = +13$  dBm, Unmodulated**



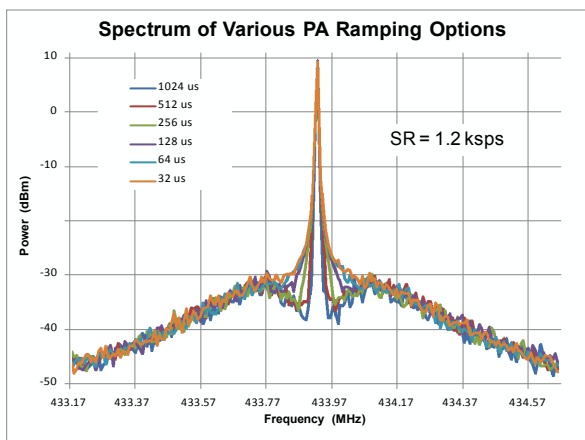
**Figure 4. Phase Noise,  $F_{RF} = 868.35$  MHz,  
 $P_{OUT} = +13$  dBm, Unmodulated**



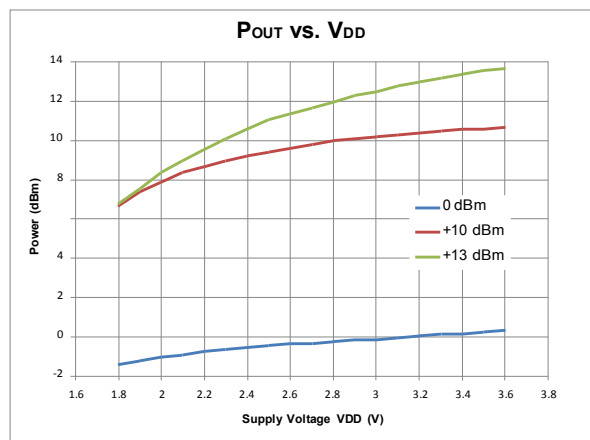
**Figure 5. OOK Spectrum, SR = 9.6 kbps,  
 $P_{OUT} = +10$  dBm,  $t_{RAMP} = 32$  us**



**Figure 6. FSK/GFSK Spectrum,  
SR = 9.6 kbps,  $F_{DEV} = 15$  kHz**

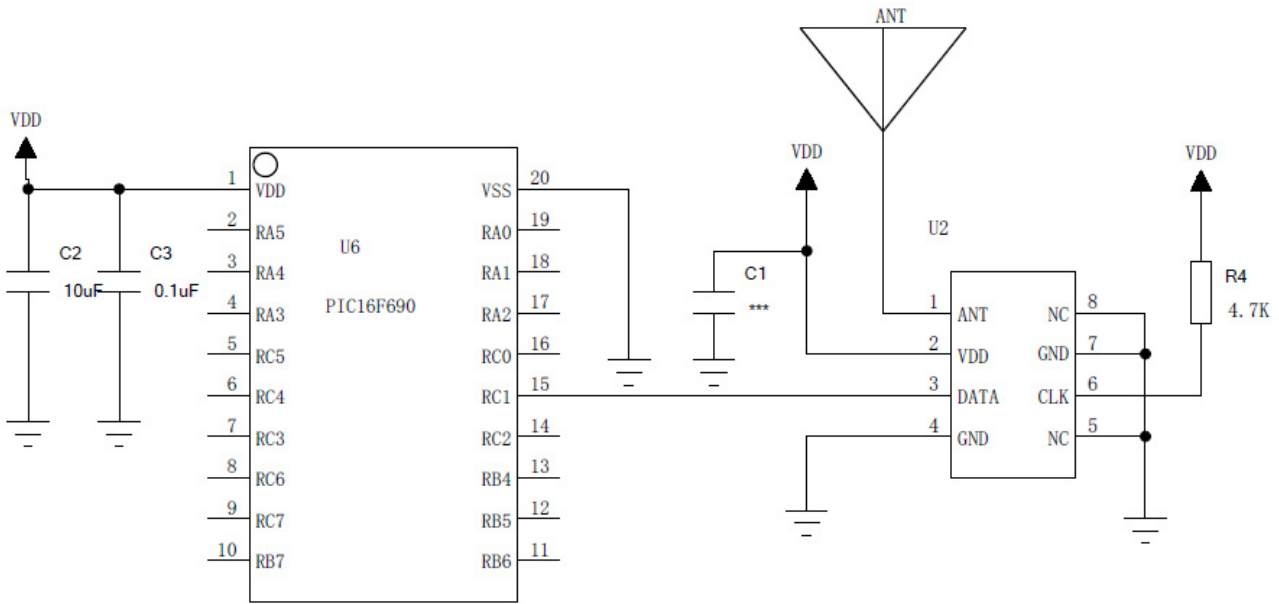


**Figure 7. Spectrum of PA Ramping,  
SR = 1.2 kbps,  $P_{OUT} = +10$  dBm**

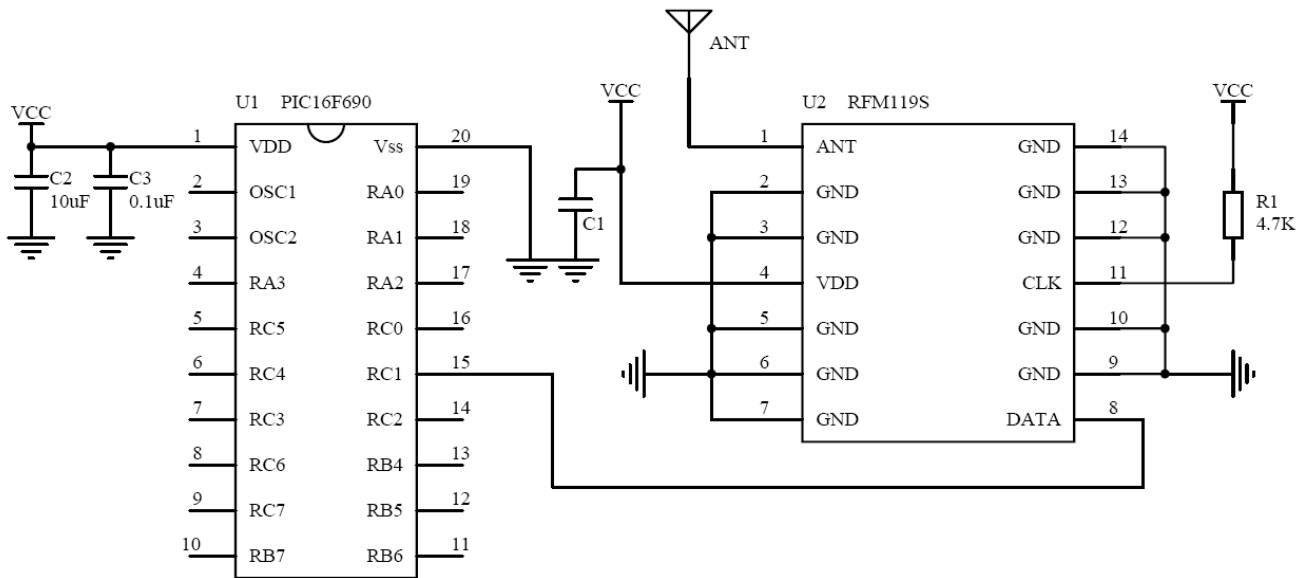


**Figure 8. Output Power vs. Supply  
Voltages,  $F_{RF} = 433.92$  MHz**

**4. Typical Application Schematics**



**RFM119W**

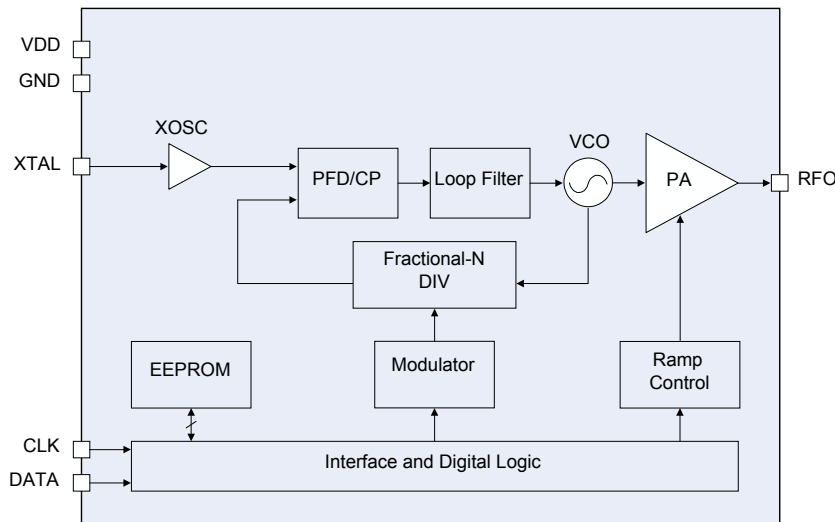


**RFM119SW**

**Figure 9: Typical Application Schematic**



## 5. Functional Descriptions



**Figure 11. RFM119W/RFM119SW Functional Block Diagram**

### 5.1 Overview

The RFM119W/RFM119SW is a high performance, highly flexible, low-cost, single-chip (G)FSK/OOK transmitter for various 240 to 960

MHz wireless applications. It is part of the HOPERF NextGenRF™ family, which includes a complete line of transmitters, receivers and transceivers. The chip is optimized for the low system cost, low power consumption, battery powered application with its highly integrated and low power design.

The functional block diagram of the RFM119W/RFM119SW is shown in the figure above. The RFM119W/RFM119SW is based on direct synthesis of the RF frequency, and the frequency is generated by a low-noise fractional-N frequency synthesizer. It uses a 1-pin crystal oscillator circuit with the required crystal load capacitance integrated on-chip to minimize the number of external components. Every analog block is calibrated on each Power-on Reset (POR) to the internal voltage reference. The calibration can help the chip to finely work under different temperatures and supply voltages. The RFM119W/RFM119SW uses the DATA pin for the host MCU to send in the data. The input data will be modulated and sent out by a highly efficient PA, which output power can be configured from -10 to +13 dBm in 1 dB step size

The user can directly use the RFM119W/RFM119SW default configuration for immediate demands. If that cannot meet the system requirement, on-line register configuration and off-line EEPROM programming configuration are available for the user to customize the chip features. The on-line configuration means there is an MCU available in the application to configure the chip registers through the 2-wire interface, while the off-line configuration is done by the HOPERF USB Programmer and the RFPDK. After the configuration is done, only the DATA pin is required for the host MCU to send in the data and control the transmission. The RFM119W/RFM119SW operates from 1.8 to 3.6 V so that it can finely work with most batteries to their useful power limits. It only consumes 15.5 mA (OOK @ 868.35 MHz) / 27.6 mA (FSK @ 868.35 MHz) when transmitting +10 dBm power under 3.3 V supply voltage.

### 5.2 Modulation, Frequency, Deviation and Symbol Rate

The RFM119W/RFM119SW supports GFSK/FSK modulation with the symbol rate up to 100 ksps, as well as OOK modulation with the symbol rate up to 30 ksps. The supported deviation of the (G)FSK modulation ranges from 1 to 200 kHz. The RFM119W/RFM119SW continuously covers the frequency range from 240 to 960 MHz, including the license free ISM frequency band around 315 MHz,

433.92 MHz, 868.35 MHz and 915 MHz. The device contains a high spectrum purity low power fractional-N frequency synthesizer with output frequency resolution better than 198 Hz when the frequency is less than 480 MHz, and is about 397 Hz

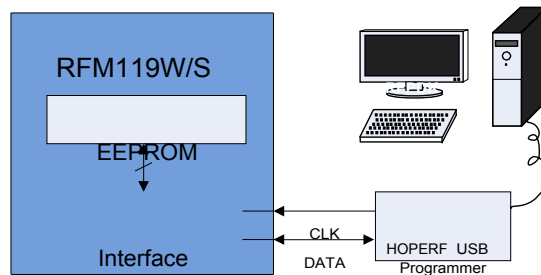
when the frequency is larger than 480 MHz. See the table below for the modulation, frequency and symbol rate specifications.

**Table 9. Modulation, Frequency and Symbol Rate**

Parameter	Value	Unit
Modulation	(G)FSK/OOK	-
Frequency	240 to 960	MHz
Deviation	1 to 200	kHz
Frequency Resolution ( $F_{RF} \leq 480$ MHz)	198	Hz
Frequency Resolution ( $F_{RF} > 480$ MHz)	397	Hz
Symbol Rate (FSK/GFSK)	0.5 to 100	ksps
Symbol Rate (OOK)	0.5 to 30	ksps

**5.3 Embedded EEPROM and RFPDK**

The RFPDK (RF Products Development Kit) is a very user-friendly software tool delivered for the user configuring the RFM119W/RFM119SW in the most intuitional way. The user only needs to fill in/select the proper value of each parameter and click the “Burn” button to complete the chip configuration. See the figure below for the accessing of the EEPROM and Table 10 for the summary of all the configurable parameters of the RFM119W/RFM119SW in the RFPDK.



**Figure 12. Accessing Embedded EEPROM**

For more details of the HOPERF USB Programmer and the RFPDK, please refer to “AN103 CMT211xA-221xA One-Way RF Link Development Kits Users Guide”. For the detail of RFM119W/RFM119SW configurations with the RFPDK, please refer to “AN122 CMT2113/19A Configuration Guideline”.

**Table 10. Configurable Parameters in RFPDK**

Category	Parameters	Descriptions	Default	Mode
RF Settings	Frequency	To input a desired transmitting radio frequency in the range from 240 to 960 MHz. The step size is 0.001 MHz.	868.35 MHz	Basic Advanced
	Modulation	The option is FSK or GFSK and OOK.	FSK	Basic Advanced
	Deviation	The FSK frequency deviation. The range is from 1 to 100 kHz.	35 kHz	Basic Advanced
	Symbol Rate	The GFSK symbol rate. The user does not need to specify symbol rate for FSK and OOK modulation.	2.4 ksp/s	Basic Advanced
	Tx Power	To select a proper transmitting output power from -10 dBm to +14 dBm, 1 dB margin is given above +13 dBm.	+13 dBm	Basic Advanced
	Xtal Load	On-chip XOSC load capacitance options: from 10 to 22 pF. The step size is 0.33 pF.	15 pF	Basic Advanced
	Data Representation	To select whether the frequency “Fo + Fdev” represent data 0 or 1. The options are: 0: F-high 1: F-low, or 0: F-low 1: F-high.	0: F-low 1: F-high	Advanced
	PA Ramping	To control PA output power ramp up/down time for OOK transmission, options are 0 and 2 <sup>n</sup> us (n from 0 to 10).	0 us	Advanced
Transmitting Settings	Start by	Start condition of a transmitting cycle, by Data Pin Rising/Falling Edge.	Data Pin Rising Edge	Advanced
	Stop by	Stop condition of a transmitting cycle, by Data Pin Holding Low for 2 to 90 ms.	Data Pin Holding Low for 20 ms	Advanced

## 5.4 Power Amplifier

A highly efficient single-ended Power Amplifier (PA) is integrated in the RFM119W/RFM119SW to transmit the modulated signal out. Depending on the application, the user can design a matching network for the PA to exhibit optimum efficiency at the desired output power for a wide range of antennas, such as loop or monopole antenna. Typical application schematics and the required BOM are shown in “Chapter 4 Typical Application Schematic”. For the schematic, layout guideline and the other detailed information please refer to “AN101 CMT211xA Schematic and PCB Layout Design Guideline”.

The output power of the PA can be configured by the user within the range from -10 dBm to +13 dBm in 1 dB step size using the HOPERF USB Programmer and RFPDK.

## 5.5 PA Ramping

When the PA is switched on or off quickly, its changing input impedance momentarily disturbs the VCO output frequency. This process is called VCO pulling, and it manifests as spectral splatter or spurs in the output spectrum around the desired carrier frequency. By gradually ramping the PA on and off, PA transient spurs are minimized. The RFM119W/S has built-in PA ramping configurability with options of 0, 1, 2, 4, 8, 16, 32, 64, 128, 256, 512 and 1024 us, as shown in Figure 13. These options are only available when the modulation type is OOK. When the option is set to “0”, the PA output power will ramp up to its configured value in the shortest possible time. The ramp down time is identical to the ramp up time in the same configuration.

HOPERF recommends that the maximum symbol rate should be no higher than 1/2 of the PA ramping “rate”, as shown in the formula below.

$$SR_{MAX} \leq 0.5 * \left( \frac{1}{t_{RAMP}} \right)$$

In which the PA ramping “rate” is given by  $(1/t_{RAMP})$ . In other words, by knowing the maximum symbol rate in the application, the PA ramping time can be calculated by formula below.

$$t_{RAMP} \leq 0.5 * \left( \frac{1}{SR_{MAX}} \right)$$

The user can select one of the values of the  $t_{RAMP}$  in the available options that meet the above requirement. If somehow the  $t_{RAMP}$  is set to be longer than “ $0.5 * (1/SR_{MAX})$ ”, it will possibly bring additional challenges to the OOK demodulation of the Rx device. For more detail of calculating  $t_{RAMP}$ , please refer to “AN122 CMT2113/19A Configuration Guideline”.

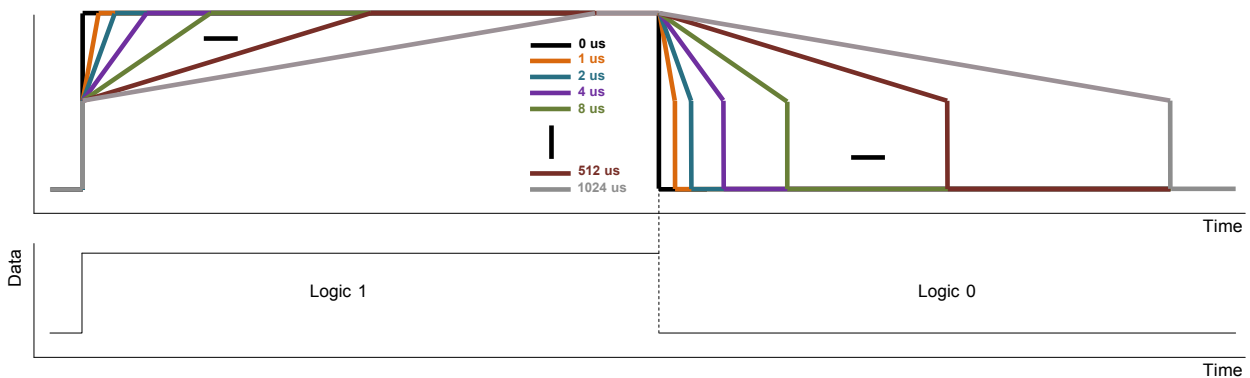


Figure 13. PA Ramping Time

### 5.6. Working States and Transmission Control Interface

The RFM119W/S has following 4 different working states: SLEEP, XO-STARTUP, TUNE and TRANSMIT.

**SLEEP**

When the RFM119W/RFM119SW is in the SLEEP state, all the internal blocks are turned off and the current consumption is minimized to 20 nA typically.

**XO-STARTUP**

After detecting a valid control signal on DATA pin, the RFM119W/RFM119SW goes into the XO-STARTUP state, and the internal XO starts to work. The valid control signal can be a rising or falling edge on the DATA pin, which can be configured on the RFPDK. The host MCU has to wait for the  $t_{XTAL}$  to allow the XO to get stable. The  $t_{XTAL}$  is to a large degree crystal dependent. A typical value of  $t_{XTAL}$  is provided in the Table 11.

**TUNE**

The frequency synthesizer will tune the RFM119W/RFM119SW to the desired frequency in the time  $t_{TUNE}$ . The PA can be turned on to transmit the incoming data only after the TUNE state is done, before that the incoming data will not be transmitted. See Figure 16 and Figure 17 for the details.

**TRANSMIT**

The RFM119W/RFM119SW starts to modulate and transmit the data coming from the DATA pin. The transmission can be ended in 2 methods: firstly, driving the DATA pin low for  $t_{STOP}$  time, where the  $t_{STOP}$  can be configured from 20 to 90 ms on the RFPDK; secondly, issuing SOFT\_RST command over the two-wire interface, this will stop the transmission in 1 ms. See Section 6.2.3 for details of the two-wire interface.

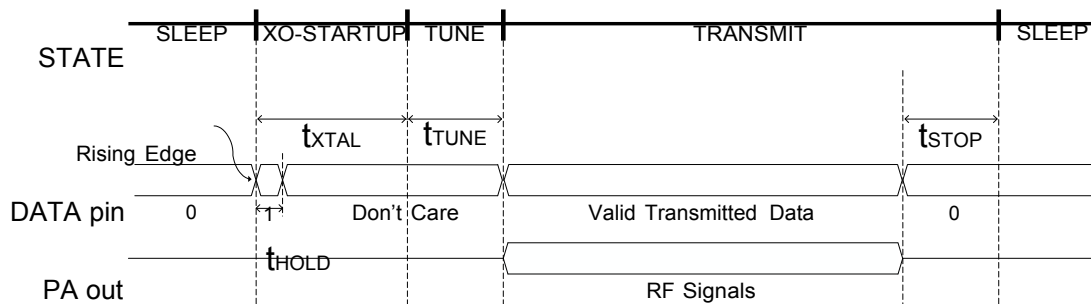
**Table 11. Timing in Different Working States**

Parameter	Symbol	Min	Typ	Max	Unit
XTAL Startup Time <sup>[1]</sup>	$t_{XTAL}$		400		us
Time to Tune to Desired Frequency	$t_{TUNE}$		370		us
Hold Time After Rising Edge	$t_{HOLD}$	10			ns
Time to Stop the Transmission <sup>[2]</sup>	$t_{STOP}$	2		90	ms

**Notes:**  
 [1]. This parameter is to a large degree crystal dependent.  
 [2]. Configurable from 2 to 9 in 1 ms step size and 20 to 90 ms in 10 ms step size.

**5.6.1 Tx Enabled by DATA Pin Rising Edge**

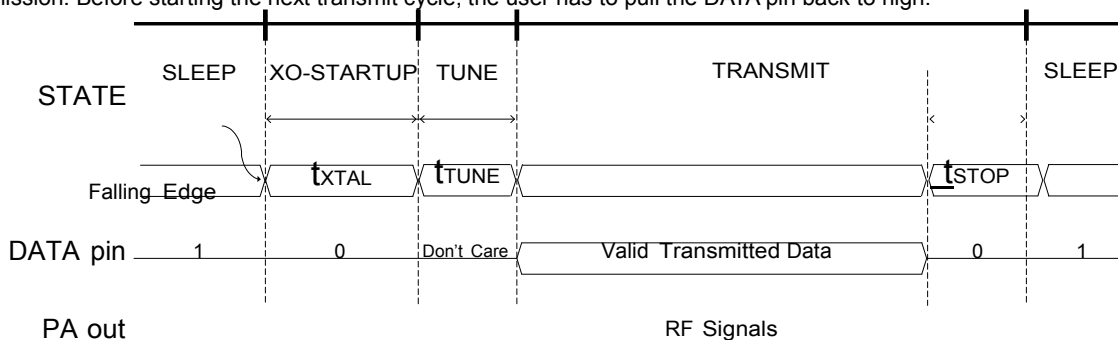
As shown in the figure below, once the RFM119W/RFM119SW detects a rising edge on the DATA pin, it goes into the XO-STARTUP state. The user has to pull the DATA pin high for at least 10 ns ( $t_{HOLD}$ ) after detecting the rising edge, as well as wait for the sum of  $t_{XTAL}$  and  $t_{TUNE}$  before sending any useful information (data to be transmitted) into the chip on the DATA pin. The logic state of the DATA pin is “Don't Care” from the end of  $t_{HOLD}$  till the end of  $t_{TUNE}$ . In the TRANSMIT state, PA sends out the input data after they are modulated. The user has to pull the DATA pin low for  $t_{STOP}$  in order to end the transmission.



**Figure 16. Transmission Enabled by DATA Pin Rising Edge**

**5.6.2 Tx Enabled by DATA Pin Falling Edge**

As shown in the figure below, once the RFM119W/RFM119SW detects a falling edge on the DATA pin, it goes into XO-STARTUP state and the XO starts to work. During the XO-STARTUP state, the DATA pin needs to be pulled low. After the XO is settled, the RFM119W/RFM119SW goes to the TUNE state. The logic state of the DATA pin is “Don't Care” during the TUNE state. In the TRANSMIT state, PA sends out the input data after they are modulated. The user has to pull the DATA pin low for  $t_{STOP}$  in order to end the transmission. Before starting the next transmit cycle, the user has to pull the DATA pin back to high.



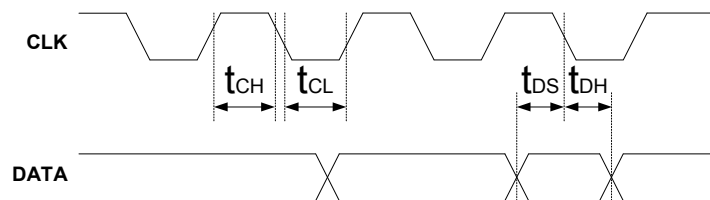
**Figure 17. Transmission Enabled by DATA Pin Falling Edge**

**5.6.3 Two-wire Interface**

For power-saving and reliable transmission purposes, the RFM119W/RFM119SW is recommended to communicate with the host MCU over a two-wire interface (TWI): DATA and CLK. The TWI is designed to operate at a maximum of 1 MHz. The timing requirement and data transmission control through the TWI are shown in this section.

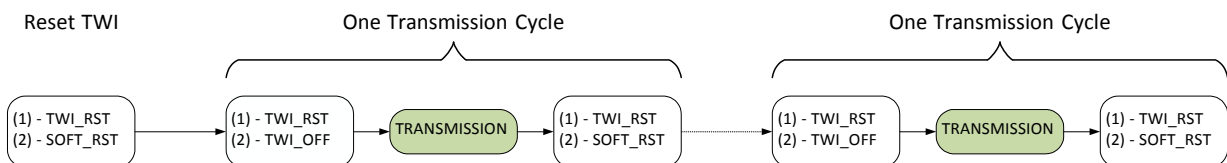
**Table 12. TWI Requirements**

Parameter	Symbol	Conditions	Min	Typ	Max	Unit
Digital Input Level High	$V_{IH}$		0.8			$V_{DD}$
Digital Input Level Low	$V_{IL}$				0.2	$V_{DD}$
CLK Frequency	$F_{CLK}$		10		1,000	kHz
CLK High Time	$t_{CH}$		500			ns
CLK Low Time	$t_{CL}$		500			ns
CLK Delay Time	$t_{CD}$	CLK delay time for the first falling edge of the TWI_RST command, see Figure 20	20		15,000	ns
DATA Delay Time	$t_{DD}$	The data delay time from the last CLK rising edge of the TWI command to the time DATA return to default state			15,000	ns
DATA Setup Time	$t_{DS}$	From DATA change to CLK falling edge	20			ns
DATA Hold Time	$t_{DH}$	From CLK falling edge to DATA change	200			ns



**Figure 18. Two-wire Interface Timing Diagram**

Once the device is powered up, TWI\_RST and SOFT\_RST should be issued to make sure the device works in SLEEP state robustly. On every transmission, TWI\_RST and TWI\_OFF should be issued before the transmission to make sure the TWI circuit functions correctly. TWI\_RST and SOFT\_RST should be issued again after the transmission for the device going back to SLEEP state reliably till the next transmission. The operation flow with TWI is shown as the figure below.

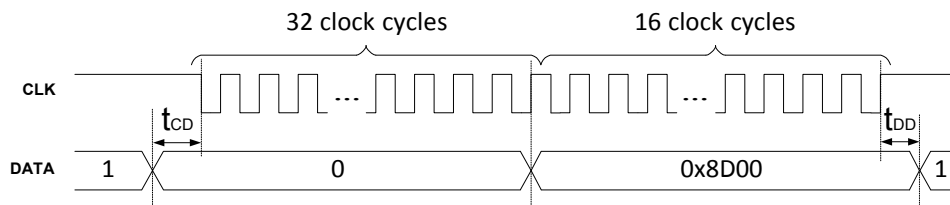


**Figure 19. RFM119W/S Operation Flow with TWI**

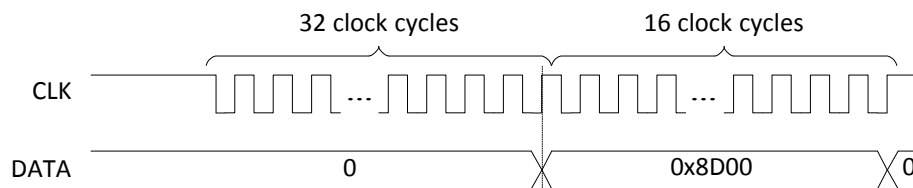
**Table 13. TWI Commands Descriptions**

Command	Descriptions
TWI_RST	<p>Implemented by pulling the DATA pin low for 32 clock cycles and clocking in 0x8D00, 48 clock cycles in total.</p> <p>It only resets the TWI circuit to make sure it functions correctly. The DATA pin cannot detect the Rising/Falling edge to trigger transmission after this command, until the TWI_OFF command is issued.</p> <p><b>Notes:</b></p> <ol style="list-style-type: none"> <li>Please ensure the DATA pin is firmly pulled low during the first 32 clock cycles.</li> <li>When the device is configured as Transmission Enabled by DATA Pin Falling Edge, in order to issue the TWI_RST command correctly, the first falling edge of the CLK should be sent <math>t_{CD}</math> after the DATA falling edge, which should be longer than the minimum DATA setup time 20 ns, and shorter than 15 <math>\mu</math>s,</li> </ol>

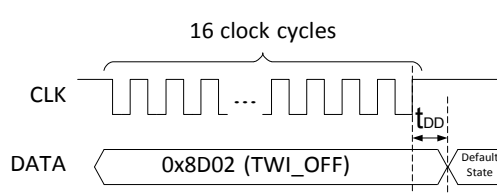
Command	Descriptions
	as shown in Figure 20. 3. When the device is configured as Transmission Enabled by DATA Pin Rising Edge, the default state of the DATA is low, there is no $t_{CD}$ requirement, as shown in Figure 21.
TWI_OFF	Implemented by clocking in 0x8D02, 16 clock cycles in total. It turns off the TWI circuit, and the DATA pin is able to detect the Rising/Falling edge to trigger transmission after this command, till the TWI_RST command is issued. The command is shown as Figure 22.
SOFT_RST	Implemented by clocking in 0xBD01, 16 clock cycles in total. It resets all the other circuits of the chip except the TWI circuit. This command will trigger internal calibration for getting the optimal device performance. After issuing the SOFT_RST command, the host MCU should wait 1 ms before sending in any new command. After that, the device goes to SLEEP state. The command is shown as Figure 23.



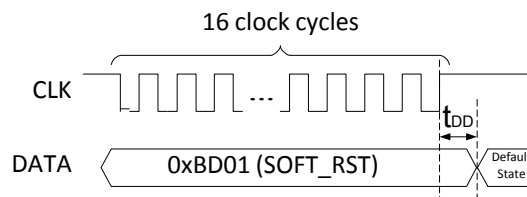
**Figure 20. TWI\_RST Command When Transmission Enabled by DATA Pin Falling Edge**



**Figure 21. TWI\_RST Command When Transmission Enabled by DATA Pin Rising Edge**



**Figure 22. TWI\_OFF Command**

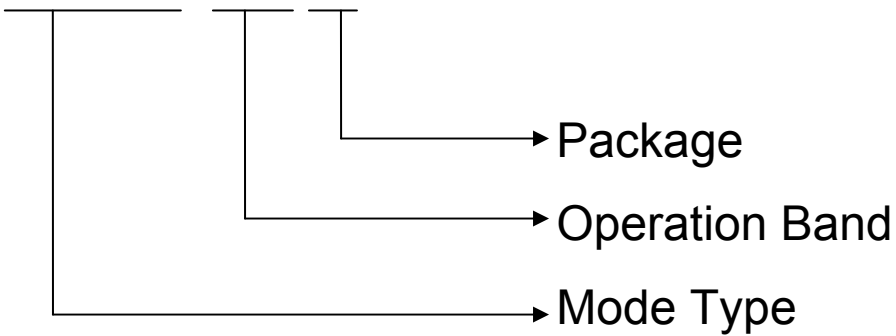


**Figure 23. SOFT\_RST Command**

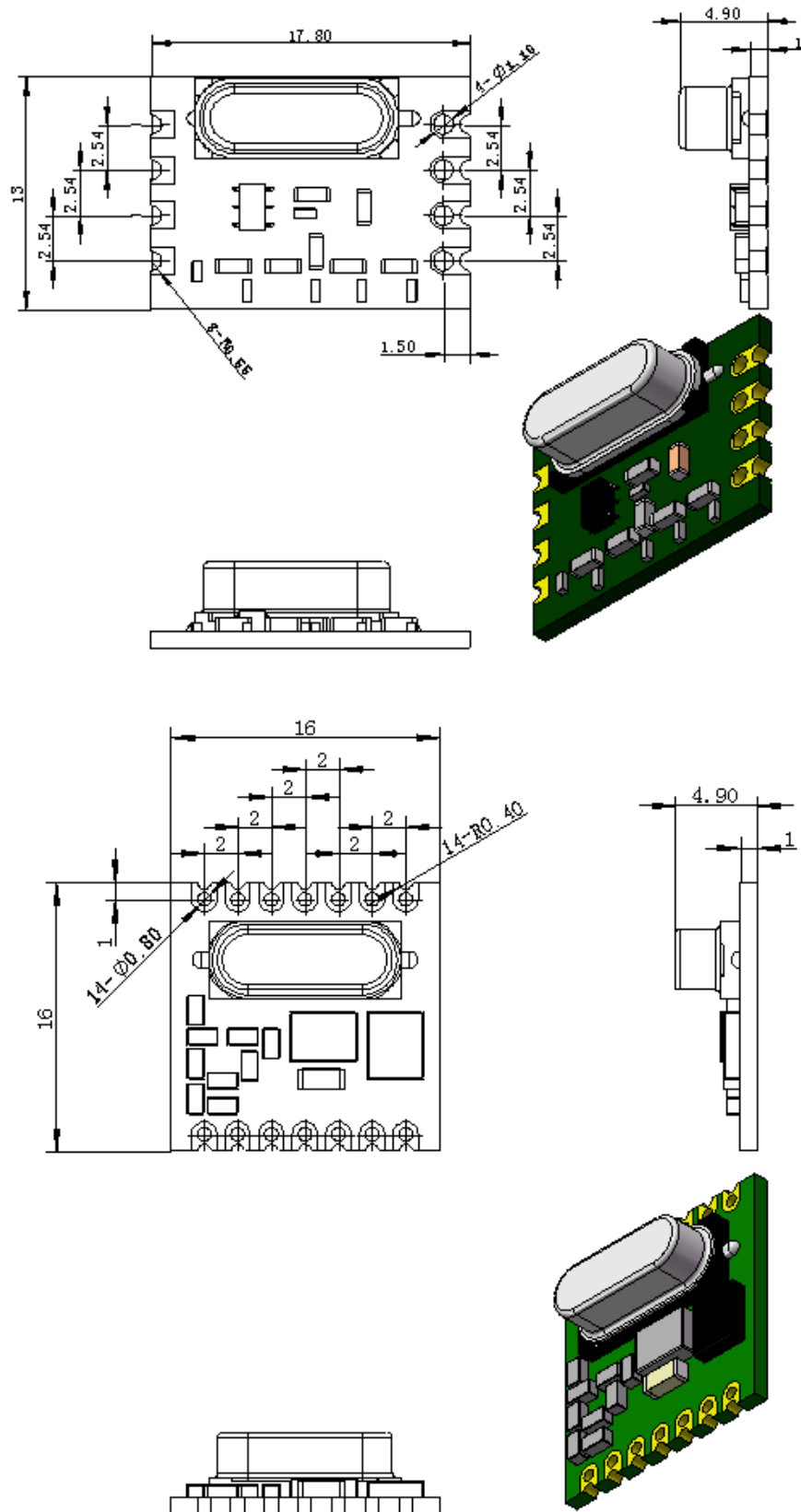
The DATA is generated by the host MCU on the rising edge of CLK, and is sampled by the device on the falling edge. The CLK should be pulled up by the host MCU during the TRANSMISSION shown in Figure 19. The TRANSMISSION process should refer to Figure 16 or Figure 17 for its timing requirement, depending on the “Start By” setting configured on the RFPDK.

The device will go to SLEEP state by driving the DATA low for  $t_{STOP}$ , or issuing SOFT\_RST command. A helpful practice for the device to go to SLEEP is to issue TWI\_RST and SOFT\_RST commands right after the useful data is transmitted, instead of waiting the  $t_{STOP}$ , this can save power significantly.



**6. Ordering Information****RFM119W-433 S1****P/N: RFM119W-315S1****RFM119W module at 315MHz band,SMD Package****P/N: RFM119SW-433S1****RFM119SW module at 433.92MHz band ,SMD Package**

## 7. Package Outline



**Figure 18** S1 Package Outline Drawing

## 8. Contact Information

### HOPE MICROELECTRONICS CO.,LTD

Add: 2/F, Building 3, Pingshan Private Enterprise Science and Technology Park, Lishan Road, XiLi Town, Nanshan District, Shenzhen, Guangdong, China

Tel: 86-755-82973805

Fax: 86-755-82973550

Email: [sales@hoperf.com](mailto:sales@hoperf.com)

Website: <http://www.hoperf.com>

<http://www.hoperf.cn>

### HOPE MICROELECTRONICS CO.,LTD

Add: 2/F, Building 3, Pingshan Private Enterprise Science and Technology Park, Lishan Road, XiLi Town, Nanshan District, Shenzhen, Guangdong, China

Tel: 86-755-82973805

Fax: 86-755-82973550

Email: [sales@hoperf.com](mailto:sales@hoperf.com)

Website: <http://www.hoperf.com>

<http://www.hoperf.cn>

This document may contain preliminary information and is subject to change by Hope Microelectronics without notice. Hope Microelectronics assumes no responsibility or liability for any use of the information contained herein. Nothing in this document shall operate as an express or implied license or indemnity under the intellectual property rights of Hope Microelectronics or third parties. The products described in this document are not intended for use in implantation or other direct life support applications where malfunction may result in the direct physical harm or injury to persons. NO WARRANTIES OF ANY KIND, INCLUDING, BUT NOT LIMITED TO, THE IMPLIED WARRANTIES OF MERCHANTABILITY OR FITNESS FOR A PARTICULAR PURPOSE, ARE OFFERED IN THIS DOCUMENT.

©2006, HOPE MICROELECTRONICS CO.,LTD. All rights reserved.

## **X-ON Electronics**

Largest Supplier of Electrical and Electronic Components

*Click to view similar products for [HOPERF](#) manufacturer:*

Other Similar products are found below :

[RF83L](#) [RFM67W-433S2](#) [RFM119W-868S1](#) [RFM67W-868S2](#) [RFM65W-433S2](#) [RFM119W-433S1](#) [RFM69HW-868S2](#) [RFM95W-868S2](#)  
[RFM98-433S2](#) [CMT2180A-ESR](#) [RF64](#) [HP203B](#) [TH06](#) [SI7006](#) [CMT2300A-EQR](#) [RF69](#) [CMT2210A-ESR](#) [CMT2210LS-ESR](#) [CMT2157A-ESR](#) [CMT2150A-ESR](#) [CMT2210A-EQR](#) [CMT2150L](#) [CMT2119A-ESR](#) [CMT2110A-ESR](#) [CMT2210LC-ESR2](#) [CMT2219A-EQR](#)  
[CMT2210LB-ESR](#)