

COMPACT SIZE, SLIM-PACKAGE, LOW POWER CONSUMPTION**DESCRIPTION**

NEXEM ED2/EF2 relay has reduced coil power consumption based compact and slim.

FEATURES

- Compact and light weight
- FCC (1500 V) and Telcordia (2500 V) surge capacity
- UL recognized and CSA certified
- Low power consumption (30-70 mW)
- Basic insulation class for EN60950

APPLICATIONS

Electronic switching systems, PBX, Terminal equipment, Telephone system

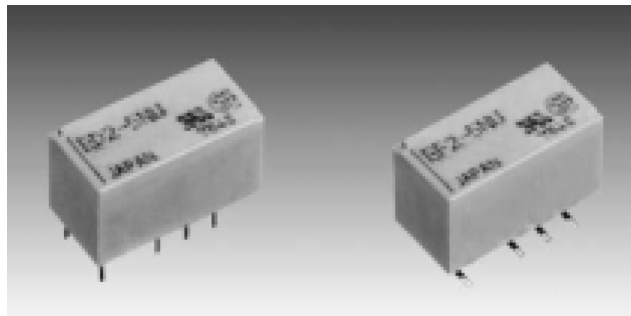
**For Right Use of Miniature Relays****DO NOT EXCEED MAXIMUM RATINGS.**

Do not use relays under exceeding conditions such as over ambient temperature, over voltage and over current. Incorrect use could result in abnormal heating, damage to related parts or cause burning.

READ CAUTIONS IN THE SELECTION GUIDE.

Read the cautions described in EM Devices' "Miniature Relays" when you choose relays for your application.

The information in this document is subject to change without notice.

© EM Devices Corporation 2017



- All specifications in this catalog and production status of products are subject to change without notice. Prior to the purchase, please contact EM Devices for updated product data.
- Please request for a specification sheet for detailed product data prior to the purchase.
- Before using the product in this catalog, please read "Precautions" and other safety precautions listed in the printed version catalog.

PIN CONFIGURATIONS (Bottom view)

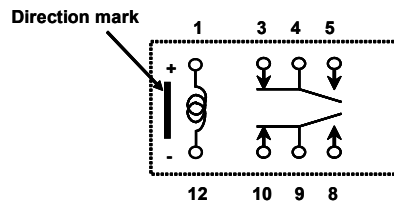

Non-latch type
(Not energized position)

MARKINGS (top view)

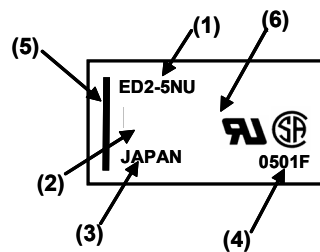

- (1) Part number
- (2) Manufacturer
- (3) Country of origin
- (4) Date code
- (5) Direction mark (pin No. 1 and 12)
- (6) UL,CSA marking

DIMENSIONS AND PAD LAYOUTS Unit: mm (inch)

ED2 SERIES

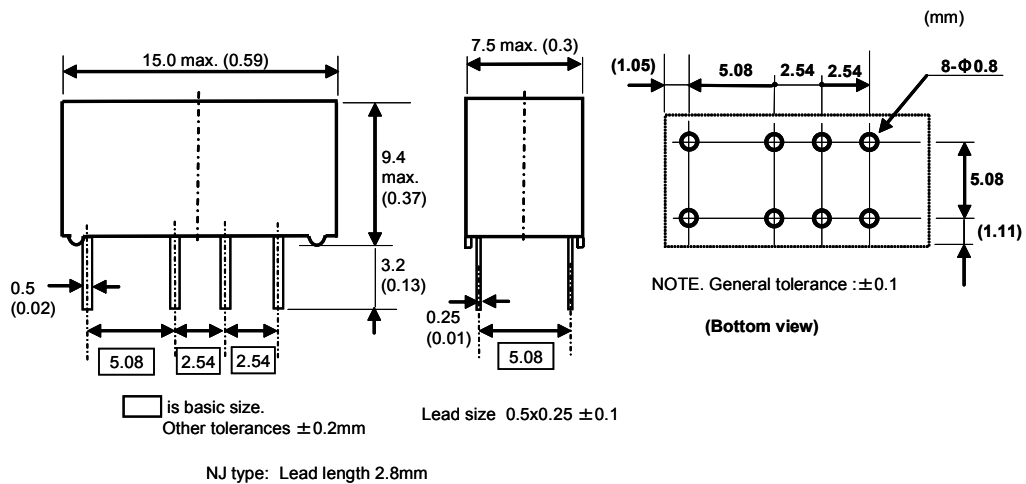

- All specifications in this catalog and production status of products are subject to change without notice. Prior to the purchase, please contact EM Devices for updated product data.
- Please request for a specification sheet for detailed product data prior to the purchase.
- Before using the product in this catalog, please read "Precautions" and other safety precautions listed in the printed version catalog.

EF2 SERIES

Standard type

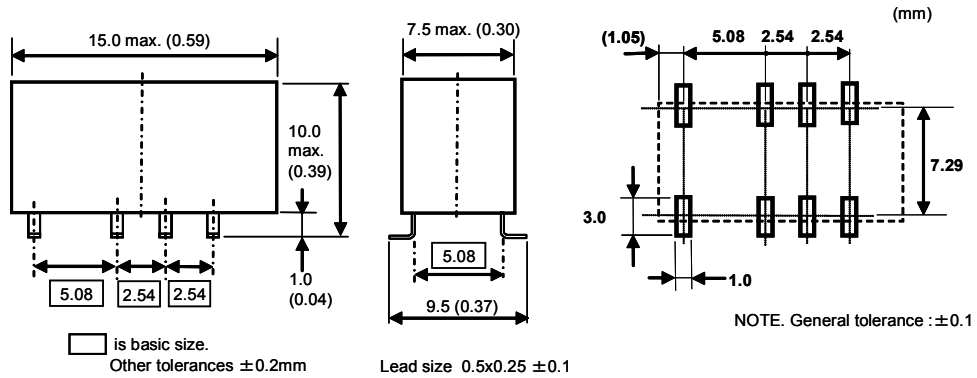

Minimum footprint type

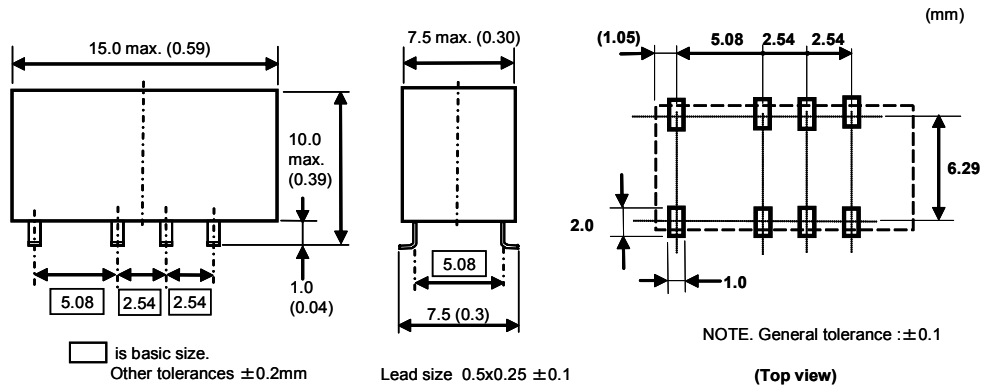

High solder joint reliability type

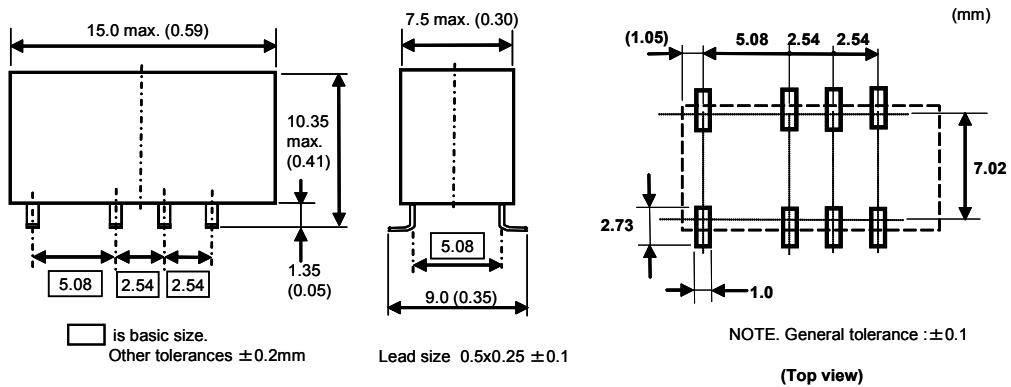

- All specifications in this catalog and production status of products are subject to change without notice. Prior to the purchase, please contact EM Devices for updated product data.
- Please request for a specification sheet for detailed product data prior to the purchase.
- Before using the product in this catalog, please read "Precautions" and other safety precautions listed in the printed version catalog.

GENERAL SPECIFICATIONS

Contact Form		2 Form C
Contact Material		Silver alloy with gold alloy overlay
Contact Ratings	Maximum Switching Power	30 W, 62.5 VA
	Maximum Switching Voltage	220 VDC, 250 VAC
	Maximum Switching Current	1 A
	Maximum Carrying Current	2 A
Minimum Contact Ratings		10 m VDC, 10µA *1
Initial Contact Resistance		75 m Ω max. (initial)
Operate Time (Excluding bounce)		Approx. 3 ms
Release Time (Excluding bounce)		Approx. 2 ms
Insulation Resistance		1000 M ohms at 500 VDC
Withstanding Voltage	Between open contacts	1000 VAC (for one minute) 1500 V surge (10x160 µs *2)
	Between adjacent contacts	1000 VAC (for one minute) 1500 V surge (10x160 µs *2)
	Between coil and contacts	1500 VAC (for one minute) , 2500 V surge (2x10 µs *3)
Shock Resistance		735 m/s ² (75G) (misoperation) 980 m/s ² (100G) (destructive failure)
Vibration Resistance		10 to 55 Hz, double amplitude 3 mm(20G) (misoperation) 10 to 55 Hz, double amplitude 5 mm(30G) (destructive failure)
Ambient Temperature		-40 to +85 °C
Coil Temperature Rise		7 °C at nominal coil voltage (50mW)
Running Specifications	Non-load	1x10 ⁸ operations *4
	Load	50 VDC 0.1A (resistive), 1x10 ⁶ operations at 85°C,5Hz 10 VDC 10mA (resistive), 1x10 ⁶ operations at 85°C,2Hz
Weight		Approx. 2.2 g

* 1 This value is a reference value in the resistance load.

Minimum capacity changes depending on switching frequency and environment temperature and the load.

* 2 rise time: 10 µs, decay time to half crest: 160 µs

* 3 rise time: 2 µs, decay time to half crest: 10 µs

* 4 This shows the number of operations with fatal defects. Stable characteristics are maintained for 1 × 10⁷ operations.



- All specifications in this catalog and production status of products are subject to change without notice. Prior to the purchase, please contact EM Devices for updated product data.
- Please request for a specification sheet for detailed product data prior to the purchase.
- Before using the product in this catalog, please read "Precautions" and other safety precautions listed in the printed version catalog.

COIL SPECIFICATIONS

Non-latch Type				at 20 °C
Nominal Coil Voltage (VDC)	Coil Resistance (Ω)±10%	Must Operate Voltage* (VDC)	Must Release Voltage* (VDC)	Nominal Operating Power (mW)
1.5	45	1.13	0.15	50
3	180	2.25	0.3	50
4.5	405	3.38	0.45	50
5	500	3.75	0.5	50
9	1473	6.75	0.9	55
12	2400	9.0	1.2	60
24	8229	18.0	2.4	70

Note * Test by pulse voltage

SAFETY STANDARD AND RATING

UL Recognized (UL508)* File No E73266	CSA Certificated (CSA C22.2 No14) File No LR46266
30 VDC, 1 A (Resistive) 110 VDC, 0.3 A (Resistive) 125 VAC, 0.5 A (Resistive)	

* Spacing: UL114, UL478

TUV Certificate (EN61810)
No. R 9950557
Non-latch type
Creepage and clearance of coil to contact is more than 2 mm. (According to EN60950)
Basic insulation class

RECOMMENDED RELAY DRIVE CONDITIONS

Drive under conditions. If it is impossible, please inquire to EM Devices.

Non-latch type	Voltage: within ±5% of nominal voltage	Ambient temperature - 40 to +85 °C
----------------	--	------------------------------------



- All specifications in this catalog and production status of products are subject to change without notice. Prior to the purchase, please contact EM Devices for updated product data.
- Please request for a specification sheet for detailed product data prior to the purchase.
- Before using the product in this catalog, please read "Precautions" and other safety precautions listed in the printed version catalog.

PART NUMBER SYSTEM

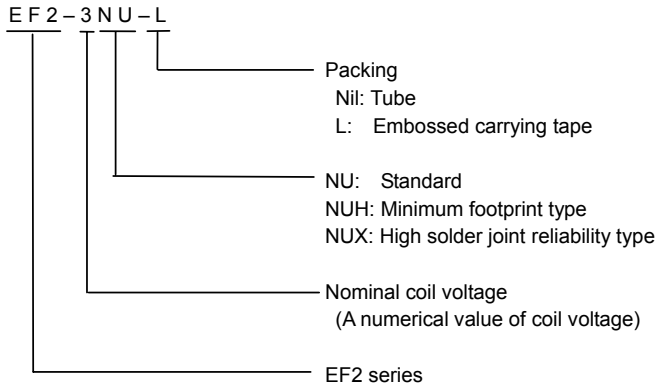
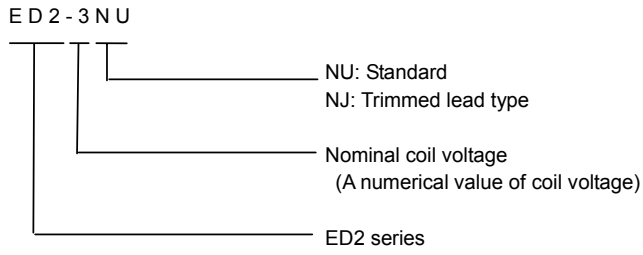

ORDERING PART NUMBERS

ED2 series

Option		Nominal Coil Voltage (VDC)	Coil Type
Terminal	Packing		Non-latch
Standard	Tube	1.5	ED2-1.5NU
		3	ED2-3NU
		4.5	ED2-4.5NU
		5	ED2-5NU
		9	ED2-9NU
		12	ED2-12NU
Trimmed lead	Tube	24	ED2-24NU
		1.5	ED2-1.5NJ
		3	ED2-3NJ
		4.5	ED2-4.5NJ
		5	ED2-5NJ
		9	ED2-9NJ
		12	ED2-12NJ
		24	ED2-24NJ



- All specifications in this catalog and production status of products are subject to change without notice. Prior to the purchase, please contact EM Devices for updated product data.
- Please request for a specification sheet for detailed product data prior to the purchase.
- Before using the product in this catalog, please read "Precautions" and other safety precautions listed in the printed version catalog.

EF2 series

Option		Nominal Coil Voltage (VDC)	Coil Type
Terminal	Packing		Non-latch
Standard	Tube	1.5	EF2-1.5NU
		3	EF2-3NU
		4.5	EF2-4.5NU
		5	EF2-5NU
		9	EF2-9NU
		12	EF2-12NU
		24	EF2-24NU
	Taping	1.5	EF2-1.5NU-L
		3	EF2-3NU-L
		4.5	EF2-4.5NU-L
		5	EF2-5NU-L
		9	EF2-9NU-L
		12	EF2-12NU-L
		24	EF2-24NU-L
Minimum footprint	Tube	1.5	EF2-1.5NUH
		3	EF2-3NUH
		4.5	EF2-4.5NUH
		5	EF2-5NUH
		9	EF2-9NUH
		12	EF2-12NUH
		24	EF2-24NUH
	Taping	1.5	EF2-1.5NUH-L
		3	EF2-3NUH-L
		4.5	EF2-4.5NUH-L
		5	EF2-5NUH-L
		9	EF2-9NUH-L
		12	EF2-12NUH-L
		24	EF2-24NUH-L
High solder joint reliability	Tube	1.5	EF2-1.5NUX
		3	EF2-3NUX
		4.5	EF2-4.5NUX
		5	EF2-5NUX
		9	EF2-9NUX
		12	EF2-12NUX
		24	EF2-24NUX
	Taping	1.5	EF2-1.5NUX-L
		3	EF2-3NUX-L
		4.5	EF2-4.5NUX-L
		5	EF2-5NUX-L
		9	EF2-9NUX-L
		12	EF2-12NUX-L
		24	EF2-24NUX-L



- All specifications in this catalog and production status of products are subject to change without notice. Prior to the purchase, please contact EM Devices for updated product data.
- Please request for a specification sheet for detailed product data prior to the purchase.
- Before using the product in this catalog, please read "Precautions" and other safety precautions listed in the printed version catalog.

PERFORMANCE DATA

☐ COIL TEMPERATURE RISE

Temperature is measured by coil resistance

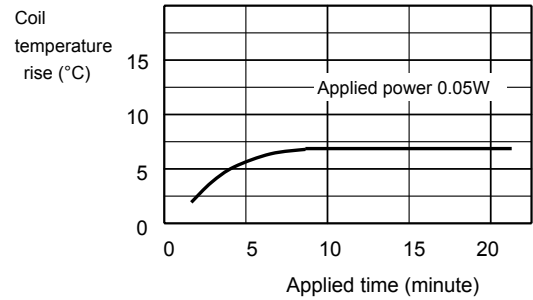
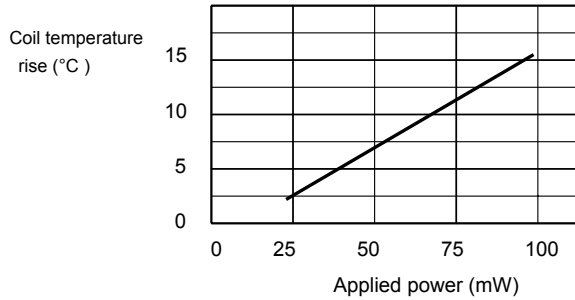

☐ SWITCHING CAPACITY

This is allowed maximum value.

Inquire with EM Devices for maximum value under continuous

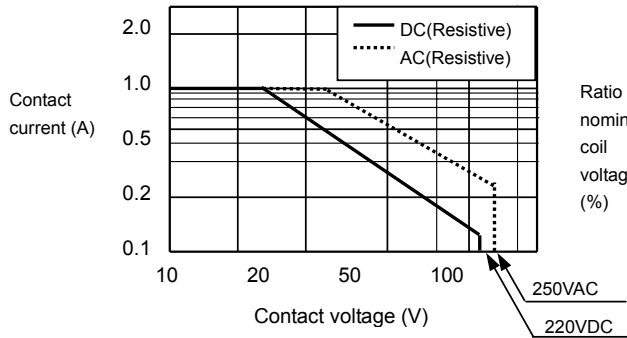

☐ MAXIMUM COIL VOLTAGE

This is a maximum value of permissible alteration.

Inquire with EM Devices for continuous use.

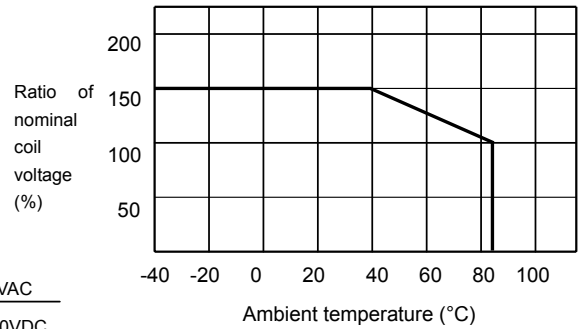

☐ APPLIED VOLTAGE VS. TIMING (Sample:ED2-5NU)

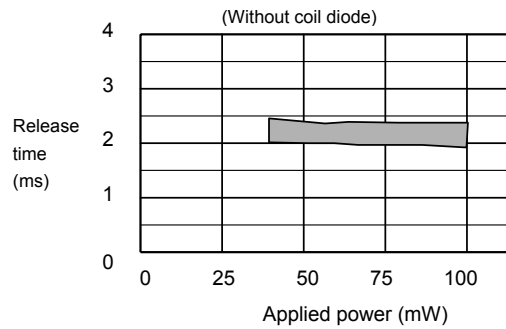
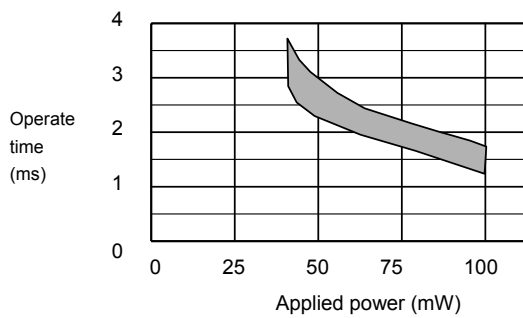

●All specifications in this catalog and production status of products are subject to change without notice. Prior to the purchase, please contact EM Devices for updated product data.
 ●Please request for a specification sheet for detailed product data prior to the purchase.
 ●Before using the product in this catalog, please read "Precautions" and other safety precautions listed in the printed version catalog.

□ OPERATE AND RELEASE VOLTAGE VS.AMBIENT TEMPERATURE

This shows a typical change of operate (release) voltage. The value of must operate is estimated, so coil voltage must be applied more than this value for safety operation. For hot start operation, please inquire with EM Devices.

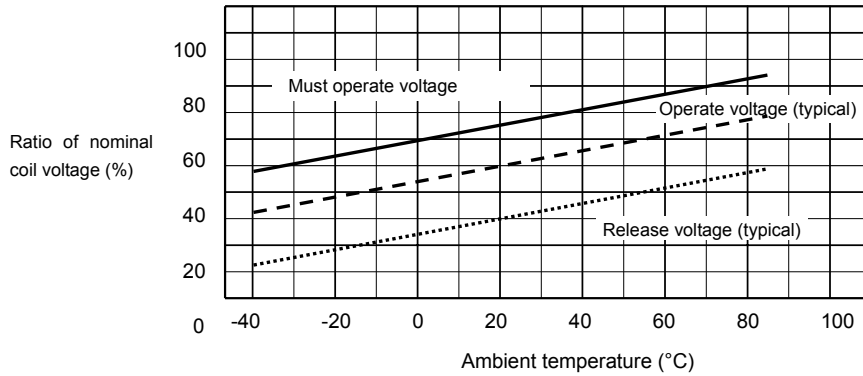

□ RUNNING TEST (Non-load)

(Load: none, Drive:5VDC, 50Hz, 50%duty, Ambient temperature :room temperature, Sample:ED2-5NU ,20pieces)

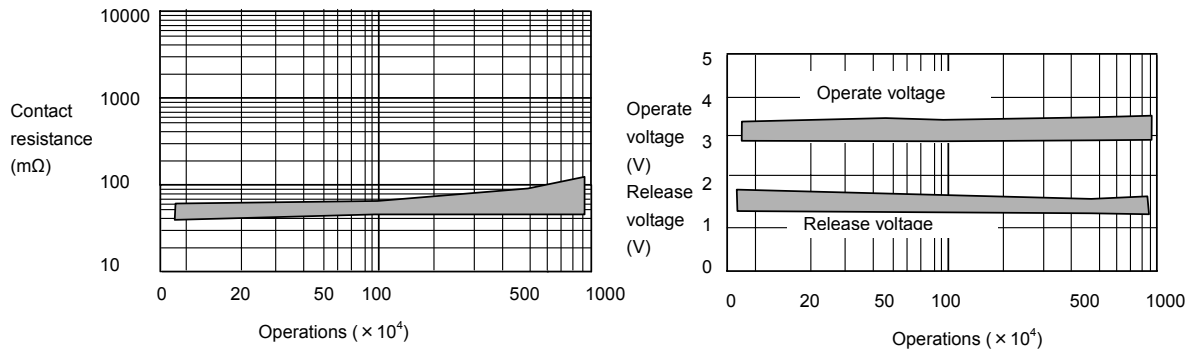

□ RUNNING TEST (Load)

(Load:50VDC 0.1A resistive,Drive:5VDC,5Hz,50%duty,Ambient temperature:85 °C, Sample:ED2-5NU ,10pieces)

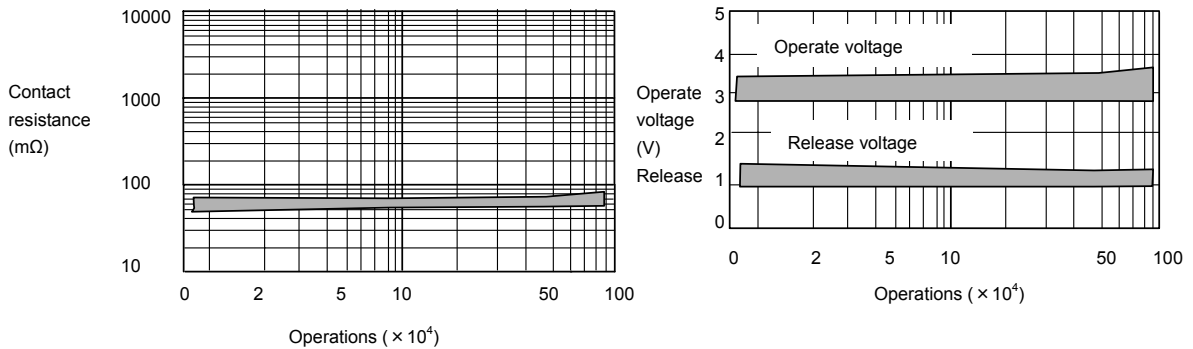

- All specifications in this catalog and production status of products are subject to change without notice. Prior to the purchase, please contact EM Devices for updated product data.
- Please request for a specification sheet for detailed product data prior to the purchase.
- Before using the product in this catalog, please read "Precautions" and other safety precautions listed in the printed version catalog.

□ BREAKDOWN VOLTAGE

Sample: ED2-5NU 10peices

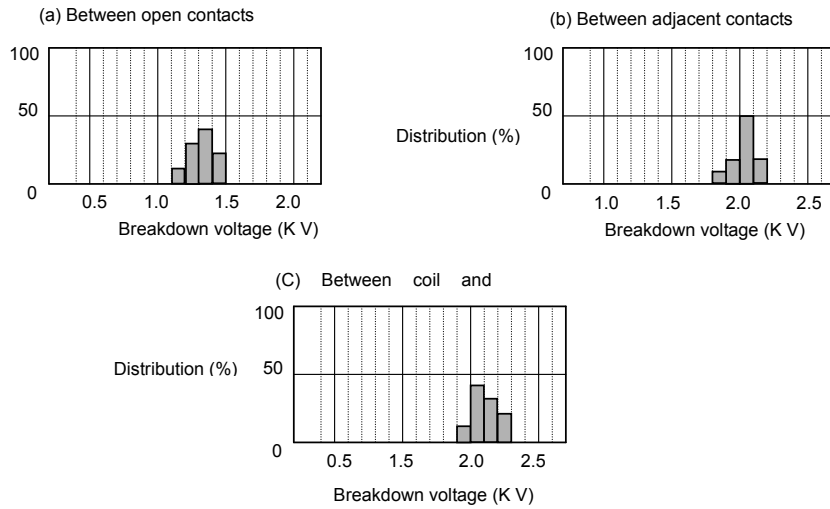

□ ALTERNATION OF VOLTAGE IN DENSE MOUNTING (Magnetic interference)

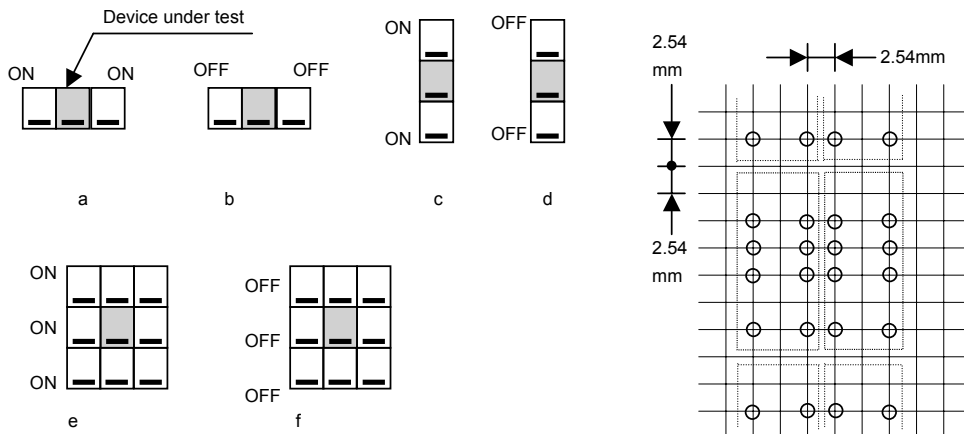
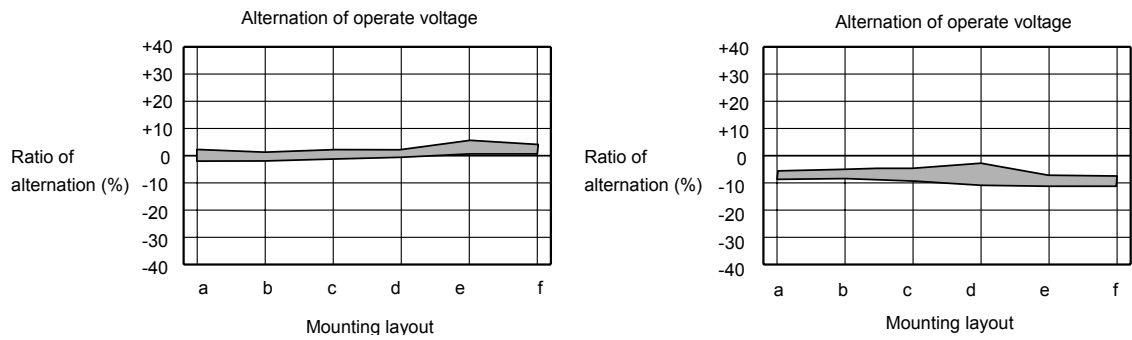

- All specifications in this catalog and production status of products are subject to change without notice. Prior to the purchase, please contact EM Devices for updated product data.
- Please request for a specification sheet for detailed product data prior to the purchase.
- Before using the product in this catalog, please read "Precautions" and other safety precautions listed in the printed version catalog.

PACKING DIMENSION (Unit: mm)

TUBE PACKING (ED2/EF2)

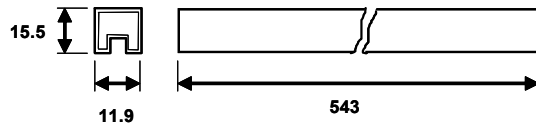

35 pieces / Tube (anti-static)

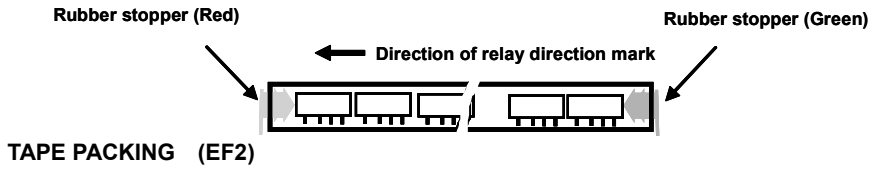

TAPE PACKING (EF2)

APPEARANCE

500 pieces / Reel
Dimension of reel: 380mm

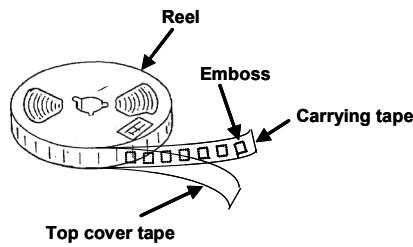

TAPE DIMENSIONS

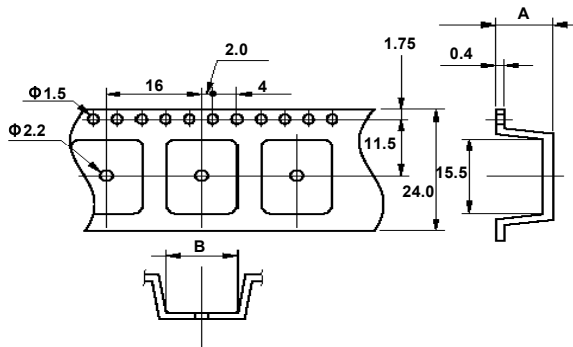

	A	B
EF2-xxNU-L	Max.10.9	10.0
EF2-xxNUX-L		
EF2-xxNUH-L	Max.11.1	8.0

RELAY DIRECTION MARK AND TAPE CARRYING DIRECTION

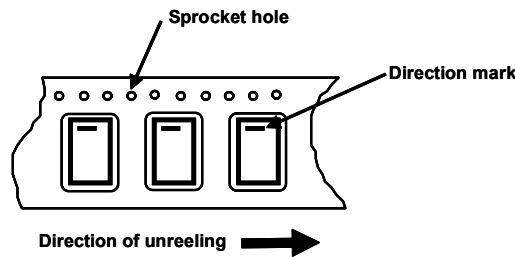

- All specifications in this catalog and production status of products are subject to change without notice. Prior to the purchase, please contact EM Devices for updated product data.
- Please request for a specification sheet for detailed product data prior to the purchase.
- Before using the product in this catalog, please read "Precautions" and other safety precautions listed in the printed version catalog.

SOLDERING TEMPERATURE CONDITION

THROUGH-HOLE MOUNTING (ED2)

1. Automatic soldering

Preheating: 110~ 120°C /110 sec. (max.)
 Solder temperature: 260°C max.
 Solder time: 5 seconds max.

Note: EM Devices recommends cooling down a printed circuit board less than 110°C within 40 seconds after soldering.

2. Manual soldering

Solder temperature: 350°C max.
 Solder time: 3 seconds max.

SURFACE-MOUNTING TYPE (EF2)

IRS Method

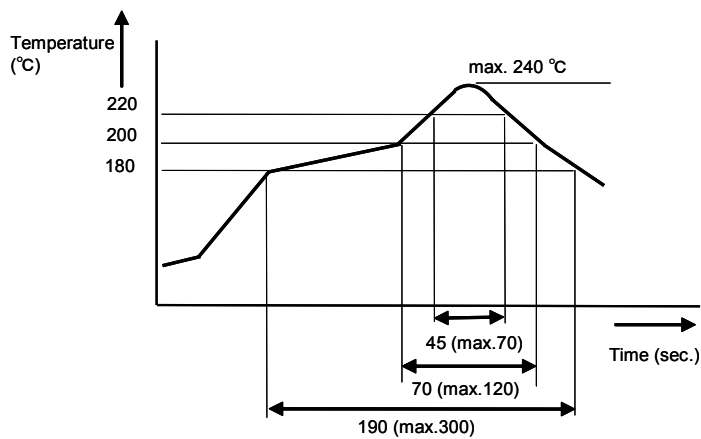

Note:

1. Temperature profile shows printed circuit board surface temperature on the relay terminal portion.
2. Check the actual soldering condition to use other method except above mentioned temperature profiles.



●All specifications in this catalog and production status of products are subject to change without notice. Prior to the purchase, please contact EM Devices for updated product data.
 ●Please request for a specification sheet for detailed product data prior to the purchase.
 ●Before using the product in this catalog, please read "Precautions" and other safety precautions listed in the printed version catalog.

NOTE ON CORRECT USE

1. Notes on contact load

Make sure that the contact load is within the specified range; otherwise, the lifetime of the contacts will be shortened considerably.

Note that the running performance shown is an example, and that it varies depending on parameters such as the type of load, switching frequency, driver circuit, and ambient temperature under the actual operating conditions. Evaluate the performance by using the actual circuit before using the relay.

2. Driving relays

- If the internal connection diagram of a relay shows + and - symbols on the coil, apply the rated voltage to the relay in the specified direction. If a rippled DC current source is used, abnormalities such as beat at the coil may occur.

- The maximum voltage that can be applied to the coil of the relay varies depending on the ambient temperature. Generally, the higher the voltage applied to the coil, the shorter the operating time. Note, however, that a high voltage also increases the bounce of the contacts and the contact opening and closing frequency, which may shorten the lifetime of the contacts.

- If the driving voltage waveform of the relay coil rises and falls gradually, the inherent performance of the relay may not be fully realized. Make sure that the voltage waveform instantaneously rises and falls as a pulse.

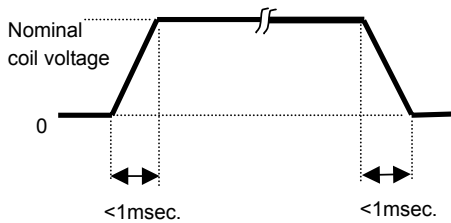

- For a latching relay, apply a voltage to the coil according to the polarity specified in the internal connection diagram of the relay.

- If a current is applied to the coil over a long period of time, the coil temperature rises, promoting generation of organic gas inside the relay, which may result in faulty contacts. In this case, use of a latching relay is recommended.

- The operating time and release time indicate the time required for each contact to close after the voltage has been applied to or removed from the coil. However, because the relay has a mechanical structure, a bounce state exists at the end of the operating and release times. Furthermore, because additional time is required until the contact stabilizes after being in a high-resistance state, care must be taken when using the relay at high speeds.

3. Operating environment

- Make sure that the relay mounted in the application set is used within the specified temperature range. Use of a relay

at a temperature outside this range may adversely affect insulation or contact performance.

- If the relay is used for a long period of time in highly humid (RH 85% or higher) environment, moisture may be absorbed into the relay. This moisture may react with the NOx and SOx generated by glow discharges that occur when the contacts are opened or closed, producing nitric or sulfuric acid. If this happens, the acid produced may corrode the metallic parts of the relay, causing operational malfunction.

- If any material containing silicon (silicon rubber, silicon oil, and silicon based coating material) is used in the neighborhood of relay, there is some possibility that these materials will emit silicon gas that will penetrate the relay. In this case, the switching contact may generate silicon compounds on the surface of contacts. This silicon compound may result in contact failure. Avoid use of relay in such an environment.

- Because the operating temperature range varies depending on the humidity, use the relay in the temperature range illustrated in the figure below. Prevent the relay from being frozen and avoid the generation of condensation.

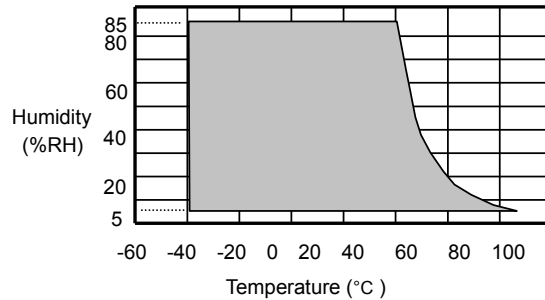

- The relay maintains constant sealability under normal atmospheric pressure (810 to 1,200 hpa). Its sealability may be degraded or the relay may be deformed and malfunction if it is used under barometric conditions exceeding the specified range.

- The same applies when the relay is stored or transported. Keep the upper-limit value of the temperature to which the relay is exposed after it is removed from the carton box to within 50°C.

- Permanent magnets are used in polarized relays. For this reason, when magnets, transformers, or speakers are located nearby the relay characteristics may change and faulty operations may result.

- If excessive vibration or shock is applied to the relay, it may malfunction and the contacts remain closed. Vibration or shock applied to the relay during operation may cause considerable damage to or wearing of the contacts. Note that operation of a snap switch mounted close to the relay or shock due to the operation of magnetic solenoid may also cause malfunctioning.



- All specifications in this catalog and production status of products are subject to change without notice. Prior to the purchase, please contact EM Devices for updated product data.
- Please request for a specification sheet for detailed product data prior to the purchase.
- Before using the product in this catalog, please read "Precautions" and other safety precautions listed in the printed version catalog.

4. Notes on mounting relays

- When mounting a relay onto a PC board using an automatic chip moulder, if excessive force is applied to the cover of the relay when the relay is chucked or inserted, the cover may be damaged or the characteristics of the relay degraded. Keep the force applied to the relay to within 1 kg.

- Avoid bending the pins to temporarily secure the relay to the PC board. Bending the pins may degrade sealability or adversely affect the internal mechanism.

- It is recommended to solder the relay onto a PC board under the following conditions:

<1> Reflow soldering

Refer to the recommended soldering temperature profile.

<2> Flow soldering

Solder temperature: 260°C max., Time: 5 seconds max.

Preheating: 110~ 120°C /110 sec. (max.)

<3> Manual soldering

Solder temperature: 350°C, Time: 2~3 seconds

- Ventilation immediately after soldering is recommended.

Avoid immersing the relay in cleaning solvent immediately after soldering due to the danger of thermal shock being applied to the relay.

- Use an alcohol-based or water-based cleaning solvent. Never use thinner and benzene because they may damage the relay housing.

- Do not use ultrasonic cleaning because the vibration energy generated by the ultrasonic waves may cause the contacts to remain closed.

5. Handling

- Relays are packaged in magazine cases for shipment. If a space is created in the case after some relays have been removed, be sure to insert a stopper to secure the remaining relays in the case. If relays are not well secured, vibration during transportation may cause malfunctioning of the contacts.

- Exercise care in handling the relay so as to avoid dropping it or allowing it to fall. Do not use a relay that has been dropped. If a relay drops from a workbench to the floor, a shock of 9,800 m/s² (1,000 G) or more is applied to the relay, possibly damaging its functions. Even if a light shock has been applied to the relay, thoroughly evaluate its operation before using it.

- Latching relays are factory-set to the reset state for shipment. A latching relay may be set, however, by vibration or shock applied while being transported. Be sure to forcibly reset the relay before using it in the application set. Also note that the relay may be set by unexpected vibration or shock when it is used in a portable set.

- The sealability of a surface-mount (SMT) relay may be lost if the relay absorbs moisture and is then heated during soldering. When storing relays, therefore, observe the following points:

<1> For standard packing, please use relays within 12 months after delivery. (Storage conditions: 30 °C / 60% RH)

If the relays have moisture absorption, dehumidify as follows.

Tape packing: 50±5 °C, 200~300 hours.

Simple relay: 85±5 °C, 48 hours.

<2> For MBB packing, please use relays within 2 years after

delivery.

(Storage conditions: 30 °C / 60% RH)

After open MBB packing, please use within 3 months.

(Storage conditions: 30 °C / 60% RH)



●All specifications in this catalog and production status of products are subject to change without notice. Prior to the purchase, please contact EM Devices for updated product data.

●Please request for a specification sheet for detailed product data prior to the purchase.

●Before using the product in this catalog, please read "Precautions" and other safety precautions listed in the printed version catalog.

No part of this document may be copied or reproduced in any form or by any means without the prior written consent of EM Devices Corporation. EM Devices Corporation assumes no responsibility for any errors which may appear in this document.

EM Devices Corporation does not assume any liability for infringement of patents, copyrights or other intellectual property rights of third parties by or arising from use of a device described herein or any other liability arising from use of such device. No license, either express, implied or otherwise, is granted under any patents, copyrights or other intellectual property rights of EM Devices Corporation or others.

While EM Devices Corporation has been making continuous effort to enhance the reliability of its electronic components, the possibility of defects cannot be eliminated entirely. To minimize risks of damage or injury to persons or property arising from a defect in an EM Devices electronic component, customers must incorporate sufficient safety measures in its design, such as redundancy, fire-containment, and anti-failure features. EM Devices' products are classified into the following three quality grades:

"Standard," "Special," and "Specific". The Specific quality grade applies only to devices developed based on a customer designated "quality assurance program" for a specific application. The recommended applications of a device depend on its quality grade, as indicated below. Customers must check the quality grade of each device before using it in a particular application.

Standard: Computers, office equipment, communications equipment, test and measurement equipment, audio and visual equipment, home electronic appliances, machine tools, personal electronic equipment and industrial robots

Special: Transportation equipment (automobiles, trains, ships, etc.), traffic control systems, anti-disaster systems, anti-crime systems, safety equipment and medical equipment (not specifically designed for life support)

Specific: Aircrafts, aerospace equipment, submersible repeaters, nuclear reactor control systems, life support systems or medical equipment for life support, etc.

The quality grade of EM Devices' products are "Standard" unless otherwise specified in EM Devices' Data Sheets or Data Books. If customers intend to use EM Devices' products for applications other than those specified for Standard quality grade, they should contact an EM Devices sales representative in advance.

(Note)

- (1) "EM Devices" as used in this statement means EM Devices Corporation and also includes its majority-owned subsidiaries.
- (2) "EM Devices electronic component products" means any electronic component product developed or manufactured by or for EM Devices (as defined above).



- All specifications in this catalog and production status of products are subject to change without notice. Prior to the purchase, please contact EM Devices for updated product data.
- Please request for a specification sheet for detailed product data prior to the purchase.
- Before using the product in this catalog, please read "Precautions" and other safety precautions listed in the printed version catalog.

X-ON Electronics

Largest Supplier of Electrical and Electronic Components

Click to view similar products for [NEXEM](#) manufacturer:

Other Similar products are found below :

[EE2-5NU-L](#) [UA2-12NU](#) [EB2-12NU-L](#) [EF2-5NU-L](#) [UB2-5NU-L](#) [EB2-5NU-L](#) [EA2-12NU](#) [EA2-24NU](#) [EF2-24NU-L](#) [EE2-12NU-L](#) [EA2-5NU](#) [UA2-24NU](#) [EB2-24NU-L](#) [UB2-12NU-L](#) [UA2-5NU](#)