

# ZS10-R1 Screw Clamp Terminal Blocks Feed-through

- With the same profile as the ZS10-ST..., the feed-through ZS10-R1 allows you to fully implement the electrical drawing of your CT or PT circuits,
- Fully compatible with the ZS10-ST... accessories.

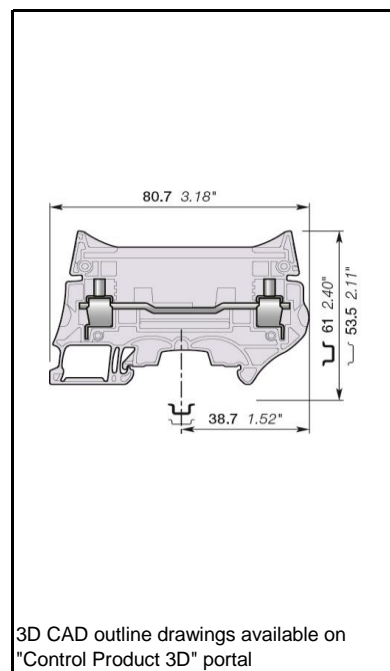

		<b>10 mm<sup>2</sup></b>
		6 AWG
<b>8 mm 0.315 in Spacing</b>		

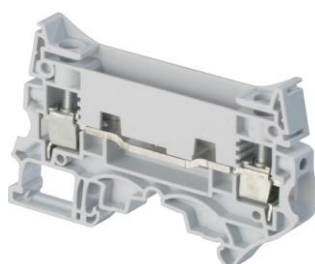







### Ordering Details

Color	Type	Order Code	EAN Code	Pack <sup>(mg)</sup>	Weight (1 pce) g
Grey	ZS10-R1	1SNK508011R0000	3472595080113	25	20.90

### Declarations and Certificates





CE	CB	RoHS	UL US	UL US	UL US	UL US	UL US	UL US	UL US	UL US	UL US
		BV		DNV							

## Declarations and Certificates

	CE		1SND225100U10*
	CB		1SND161092A02*
	RoHS		1SND230516F02*
	USR CNR		1SND161041A02*
	CSA		1SND161070A02*
	EAC		1SND161009A11*
	BV		1SND161073A02*
	DNV		1SND161087A02*

## General Information

The following information must be strictly adhered to in order to guarantee the terminal block electrical, mechanical and environmental performance.

Protection	IEC 60947-1	IP20		NEMA 1				
Rail		TH 35-7.5, TH 35-15						
Wire stripping length		13 mm	0.512 in					
Operating tool		Screw clamp Flat screwdriver		Screw rail contact (Maximum value)		Disconnect device		
		3.5 mm	0.138 in					
Torque		1.3 N.m ± 0.3 N.m	11.5 N.m ± 2.65 N.m			0.5 N.m	4.45 lb.in	

## Material Specifications

Insulating material	Polyamide
CTI	600 V
Flammability	UL94 V0
	NF F 16101 I2F2
	Needle flame test: C 60615-11-5
	Compliant

## Connecting capacity per clamp

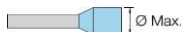
		Screw clamp			
1 Rigid - Solid / Stranded conductor	Norme				
	Value	0.5 ... 10 mm <sup>2</sup>	24 ... 6 AWG		
1 Flexible conductor	Norme				
	Value	0.5 ... 10 mm <sup>2</sup>			
1 Flexible conductor with non insulated ferrule	Norme	Manufacturer data	Manufacturer data		
	Value	0.5 ... 10 mm <sup>2</sup>	24 ... 8 AWG		
1 Flexible conductor with insulated ferrule	Norme	Manufacturer data	Manufacturer data		
	Value	0.5 ... 6 mm <sup>2</sup>	24 ... 10 AWG		
Gauge		A5-B5	5.2 mm		
		IEC 60947-1	0.205 in		
Ferrule maximum outer diameter or conductor insulation maximum outer diameter		Manufacturer data	7.5 mm	0.295 in	

The "Connecting capacity with ferrule" data is guaranteed with ABB crimping tool PS-3 (crimping capacity up to 10 mm<sup>2</sup>).

As part of its on-going product improvement, ABB reserves the right to modify the characteristics or the products described in this document. The information given is not contractual. For further details please contact the ABB company marketing these products in your country.

## Multi Connecting capacity per clamp

2 Rigid - Solid / Stranded conductors	Norme			
	Value	0.5 ... 4 mm <sup>2</sup>	20 ... 12 AWG	
2 Flexible conductors	Norme			
	Value	0.5 ... 4 mm <sup>2</sup>		
2 Flexible conductors with twin ferrule	Norme	Manufacturer data	Manufacturer data	
	Value	0.5 ... 4 mm <sup>2</sup>	20 ... 12 AWG	

Don't mix **solid and flexible** conductors **in the same clamp**

Don't mix **solid or flexible** conductors of different sizes **in the same clamp**

The "Connecting capacity with ferrule" data is guaranteed with ABB crimping tool PS-3 (crimping capacity up to 10 mm<sup>2</sup>)

## Cross section

Rated cross section		10 mm <sup>2</sup>		6 AWG
Maximum Cross section	Manufacturer data	10 mm <sup>2</sup>	Manufacturer data	6 AWG

## Electrical characteristics

### Current

Rated current				57 A
	Field and factory wiring Cat.2		UL 1059	62 A
	Factory wiring Cat.1		UL 1059	62 A
			CSA-C-22.2 n°158	62 A
Maximum Exe current			IEC/EN 60079-7	
Rated short-time withstand current 1 s (I <sub>cw</sub> )				1200 A
Short-time withstand current	0.5 s	Manufacturer data		
	5 s	Manufacturer data		
	10 s	Manufacturer data		
	30 s	Manufacturer data		
	1 min	Manufacturer data		
Rated short-circuit withstand current			UL 1059	
Max. current (45° temperature increase) / Max. cross section (mm <sup>2</sup> )			Manufacturer data	10 mm <sup>2</sup>
Maximum short circuit current (1s)			Manufacturer data	1200 A

### Short Circuit Current Rating (SCCR) SA UL 1059 supplement

SCCR		UL 1059	
With the following configurations:			
Suitable conductor wire range			
Maximum voltage			
Fuse class / Max. amp. Rating		J	
		T	
		RK1	
		RK5	
		G	
		CC	

### Voltage

Rated voltage	IEC 60947-1	630 V
Rated voltage	UL 1059	300 V
Use Group	UL 1059	B,C
Rated voltage	CSA-C-22.2 n°158	300 V
Rated voltage Ex e	IEC/EN 60079-7	
Rated impulse withstand voltage	IEC 60947-1	8000 V
Dielectric test voltage	IEC 60947-1	2000 V
Pollution degree	IEC 60947-1	3
Overvoltage category	IEC 60947-1	III

## Temperature range

Ambient temperature min/max	Storage	-55 ... +110 °C	-67 ... +230 °F
	Installing	-5 ... +40 °C	+23 ... +104 °F
	Service	-55 ... +110 °C	-67 ... +230 °F

## Dissipated power

Maximum dissipated power at rated current	IEC 60947-1	3.3 W
Maximum dissipated power at maximum Exe current	IEC 60079-7	

## Rated power dissipation at an ambient temperature of 23 °C - IEC 60947-7-3

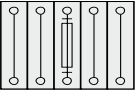
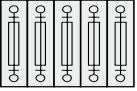
Separate arrangement / Overload and short-circuit protection	 1 fuse and 4 feed-through blocks	
Separate arrangement / Exclusive short-circuit protection		
Compound arrangement / Overload and short-circuit protection	 5 fuse blocks	
Compound arrangement / Exclusive short-circuit protection		

## Environmental Characteristics

### Additional climatic tests

Dry heat		IEC 60068-2 2	Compliant
	Conditions	Temperature	+100 °C
		Duration of test	96 h
Cyclic damp heat		IEC 60068-2 30	Compliant
	Conditions	Temperature	+55 °C
		Relative humidity	
		Number of cycles (1 cycle = 24h)	2
Cold		IEC 60068-2 1	Compliant
	Conditions	Temperature	-40 °C
		Duration of test	96 h
Damp heat steady state		IEC 60068-2-78	
	Conditions	Temperature	
		Relative humidity	
		Duration of test	

## Corrosion

Salt mist		IEC 60068-2 11	Compliant
	Conditions	Duration of test	96 h
		Concentration	5 %
SO <sub>2</sub>		ISO 6988	Compliant
	Conditions	Duration of test	48 h
		Concentration	0.2 dm <sup>3</sup>
Flowing mixed gas corrosion test		IEC 60068-2 60	
	Conditions	Number of the test method	
		Duration of test	

As part of its on-going product improvement, ABB reserves the right to modify the characteristics or the products described in this document. The information given is not contractual. For further details please contact the ABB company marketing these products in your country.

## Vibrations and shocks

Sinusoidal vibrations	Conditions	IEC 60068-2-6	
		Frequency range	10 ... 55 Hz
		Number of cycles	10
		Acceleration	10 m/s <sup>2</sup>
Functional random vibrations Category 1 Class B 3 axes	Conditions	IEC 61373	
		Duration of test	
		Frequency range	
		Acceleration	
Long life testing at increased random vibrations Category 1 Class B 3 axes	Conditions	IEC 61373	
		Duration of test	
		Frequency range	
		Acceleration	
Shock Category 1 Class B 3 axes	Conditions	IEC 61373	
		Duration of test	
		Acceleration	

## ZS10-R1 Terminal Block Accessories Compatibility

Some accessories may modify the terminal block's rating. See complete information in the accessories catalog page.

Description	Type	Order Code	Pack <sup>(ing)</sup> pieces	Weight g (1 pce)
1 Terminal Block Markers	MG-CPM 13	1SNB041791R0612	1680	0.273
	MC812	1SNK160000R0000	22	10.00
	MC812PA	1SNK160011R0000	1	14.00
	MC812PA	1SNK169999R0000	20	14.00
	UMH	1SNK900611R0000	10	0.20
	SAT8	1SNK900616R0000	5	6.00
2 End Sections	ES10-ST	1SNK508910R0000	20	3.5
3 End Stops	BAM4	1SNK900001R0000	50	14.00
	BAZ1	1SNK900002R0000	50	5.30
	BAZH1	1SNK900102R0000	20	24.00
4 Circuit Separators	CS-R3	1SNK900107R0000	20	6.40
5 Protecting Covers	CO	1SNK900604R0000	1	300.00
6 Protecting Cover Kits	KCO	1SNK900624R0000	1	47.80
7 Jumper Bars	JB8-2-R1	1SNK908902R0000	10	7.6
	JB8-3-R1	1SNK908903R0000	10	11.6
	JB8-4-R1	1SNK908904R0000	10	15.5
	JB8-5-R1	1SNK908905R0000	10	19.4
	JB8-10-R1	1SNK908910R0000	10	39.00
8 Lateral Jumper Bars	PC8-2	1SNA116538R1700	10	3.00
	PC8-3	1SNA116539R1000	10	4.00
	PC8-4	1SNA116540R2500	10	6.00
	PC8-10	1SNA163313R2400	10	14.00
	PC8-R1	1SNA400711R0600	10	6.60
	PC8-R2	1SNA400712R0700	10	7.80
	PC8-R3	1SNA400713R0000	10	9.00
	PC8-R4	1SNA400724R0300	10	4.50
		1SNA400842R0000		
		1SNA400843R0000		
	1SNA400849R0000			
	1SNA400850R0000			
9 Short Circuit Plugs	BP8.A4	1SNA173888R2000	10	
10 Test Sockets	AJS9	1SNA179726R0200	25	3.60
	AJS9-BK	1SNA206680R1500	25	3.60
	AJS9-GN	1SNA206681R0200	25	3.60
	AJS9-GR	1SNA206682R0300	25	3.60
	AJS9-BL	1SNA206683R0400	25	3.60
	AJS9-RD	1SNA206720R1400	25	3.60
	AL4-M3	1SNA206721R0100	50	1.10
	AJS10	1SNA206759R0000	100	5.00
11 Short Circuit Bridges	SC-JB8-2	1SNK900652R0000	25	2.00
	SC-JB8-3	1SNK900653R0000	25	3.4

As part of its on-going product improvement, ABB reserves the right to modify the characteristics or the products described in this document. The information given is not contractual. For further details please contact the ABB company marketing these products in your country.



# Contact us

**ABB France**  
**Electrification Products Division**  
**PG Connection**  
3, rue Jean Perrin  
F-69687 Chassieu cedex / France  
Tel. +33 (0)4 7222 1722  
Fax +33 (0)4 7222 1935

*Note*

*We reserve the right to make technical changes or modify the contents of this document without prior notice. With regard to purchase orders, the agreed particulars shall prevail. ABB does not accept any responsibility whatsoever for potential errors or possible lack of information in this document.*

*We reserve all rights in this document and in the subject matter and illustrations contained therein. Any reproduction, disclosure to third parties or utilization of its contents – in whole or in parts – is forbidden without prior written consent of ABB.*

Copyright© 2011 ABB  
All rights reserved

1 SNK161059D0201 - PDF

## X-ON Electronics

Largest Supplier of Electrical and Electronic Components

*Click to view similar products for [TE CONNECTIVITY](#) manufacturer:*

Other Similar products are found below :

[D38999/24FJ4AN](#) [1-2000677-8](#) [SMD100-2](#) [D38999/20WJ43BD](#) [4-176756-8](#) [983-6SE22-12S7-L](#) [D38999/24ZE35PN](#) [DJT10F17-26HN](#) [5-1437490-9](#) [7022X3H](#) [983-6SE18-14P9-L](#) [AFD50-16-23SN-6116-LC](#) [603995-1](#) [D38999/24WF32JE](#) [D38999/24WF32SE-LC](#) [DTS24W19-32HE](#) [D38999/20WD19SB-LC](#) [842723N001](#) [213904-1](#) [C1177A](#) [AFD51-18-32PW-6116-LC](#) [D38999/24FD19PD](#) [D38999/24FD19PD-LC](#) [D38999/24FF32BA](#) [D38999/26WH21PB-LC](#) [D38999/20FH21PE](#) [D38999/20FH21PE-LC](#) [D38999/24FH21PN](#) [DTS20F23-21PE](#) [D38999/20FH21PB-LC](#) [D38999/26FJ35PE](#) [D38999/32Z15N](#) [DTS26W9-35JB-LC](#) [D38999/26JJ29JN](#) [102976-7](#) [D38999/20FJ4SB-LC](#) [1-2322421-6](#) [D38999/20FJ24SB-LC](#) [MS3474L12-10P-LC](#) [MS3474L12-10PW-LC](#) [MS27467T21F16P-LC](#) [D50184-000](#) [WINTOTAL-6-END-USER-LICENCE](#) [164-8033-08](#) [DTS26W17-99HA](#) [MS27468T17F26H](#) [DJT14F17-26HN](#) [DJT14F17-26HB](#) [AFD58-24-61PY-1A](#) [983-6SE18-14S7-L](#)