

Pluggable interface relays CR-U Universal relays

Pluggable interface relays are used for electrical isolation, amplification and signal matching between the electronic controlling, e.g. PLC (programmable logic controller), PC or field bus systems and the sensor / actuator level. They don't use additional internal protective circuits and thus are overload-proof against short-time variations like current or voltage peaks.











2CDC 281 047 F0004

Characteristics

- Standard universal relays with mechanical status indication
- 12 different supply voltages:
DC versions: 12 V, 24 V, 48 V, 110 V, 125 V, 220 V
AC versions: 24 V, 48 V, 60 V, 110 V, 120 V, 230 V
- Output: 2 c/o (SPDT) contacts (10 A), 3 c/o (SPDT) contacts (10 A)
- Available with or without LED
- Integrated test button for manual actuation and locking of output contacts (DC coil = blue, AC coil = orange) that can be removed if necessary
- Cadmium-free contact material
- Width on socket: 38 mm (1.496 in)
- Pluggable function modules: reverse polarity protection/free wheeling diode, LED indication, RC elements, overvoltage protection, multifunction time module

Approvals

	ANSI/UL 508	
	CAN/CSA C22.2 No.14	
	CAN/CSA C22.2 No.14	(except 60 V and 125 V devices)
	VDE	(except 125 V devices)
	EAC	
	Lloyds Register	
	CCC	(except 125 V devices)
	RMRS	(except 60 V and 125 V devices)

Marks

 CE CE

Order data

Packing unit = 10 pieces

Interface relays without LED, 2 c/o (SPDT) contacts: 250 V, 10 A

Type	Rated control supply voltage U_s	Order code
CR-U012DC2	12 V DC	1SVR 405 621 R4000
CR-U024DC2	24 V DC	1SVR 405 621 R1000
CR-U048DC2	48 V DC	1SVR 405 621 R6000
CR-U110DC2	110 V DC	1SVR 405 621 R8000
CR-U220DC2	220 V DC	1SVR 405 621 R9000
CR-U024AC2	24 V AC	1SVR 405 621 R0000
CR-U048AC2	48 V AC	1SVR 405 621 R5000
CR-U110AC2	110 V AC	1SVR 405 621 R7000
CR-U120AC2	120 V AC	1SVR 405 621 R2000
CR-U230AC2	230 V AC	1SVR 405 621 R3000

Interface relays without LED, 3 c/o (SPDT) contacts: 250 V, 10 A

CR-U012DC3	12 V DC	1SVR 405 622 R4000
CR-U024DC3	24 V DC	1SVR 405 622 R1000
CR-U048DC3	48 V DC	1SVR 405 622 R6000
CR-U110DC3	110 V DC	1SVR 405 622 R8000
CR-U125DC3	125 V DC	1SVR 405 622 R8200
CR-U220DC3	220 V DC	1SVR 405 622 R9000
CR-U024AC3	24 V AC	1SVR 405 622 R0000
CR-U048AC3	48 V AC	1SVR 405 622 R5000
CR-U060AC3	60 V AC	1SVR 405 622 R5200
CR-U110AC3	110 V AC	1SVR 405 622 R7000
CR-U120AC3	120 V AC	1SVR 405 622 R2000
CR-U230AC3	230 V AC	1SVR 405 622 R3000

Interface relays with LED, 2 c/o (SPDT) contacts: 250 V, 10 A

CR-U012DC2L	12 V DC	1SVR 405 621 R4100
CR-U024DC2L	24 V DC	1SVR 405 621 R1100
CR-U048DC2L	48 V DC	1SVR 405 621 R6100
CR-U110DC2L	110 V DC	1SVR 405 621 R8100
CR-U220DC2L	220 V DC	1SVR 405 621 R9100
CR-U024AC2L	24 V AC	1SVR 405 621 R0100
CR-U048AC2L	48 V AC	1SVR 405 621 R5100
CR-U110AC2L	110 V AC	1SVR 405 621 R7100
CR-U120AC2L	120 V AC	1SVR 405 621 R2100
CR-U230AC2L	230 V AC	1SVR 405 621 R3100

Interface relays with LED, 3 c/o (SPDT) contacts: 250 V, 10 A

CR-U012DC3L	12 V DC	1SVR 405 622 R4100
CR-U024DC3L	24 V DC	1SVR 405 622 R1100
CR-U048DC3L	48 V DC	1SVR 405 622 R6100
CR-U110DC3L	110 V DC	1SVR 405 622 R8100
CR-U220DC3L	220 V DC	1SVR 405 622 R9100
CR-U024AC3L	24 V AC	1SVR 405 622 R0100
CR-U048AC3L	48 V AC	1SVR 405 622 R5100
CR-U110AC3L	110 V AC	1SVR 405 622 R7100
CR-U120AC3L	120 V AC	1SVR 405 622 R2100
CR-U230AC3L	230 V AC	1SVR 405 622 R3100

Interface relays with LED and freewheeling diode, 3 c/o (SPDT) contacts: 250 V, 10 A

CR-U024DC3LD	24 V DC	1SVR 405 623 R1100
--------------	---------	--------------------

Accessories

Sockets

Type	Version	Order code
------	---------	------------

Sockets

CR-U2S	for 2 c/o (SPDT) contacts + module	1SVR 405 670 R0000
CR-U3S	for 3 c/o (SPDT) contacts + module	1SVR 405 660 R0000
CR-U3E	for 3 c/o (SPDT) contacts	1SVR 405 660 R0100

Small sockets

CR-U2SM	for 2 c/o (SPDT) contacts	1SVR 405 670 R1100
CR-U3SM	for 3 c/o (SPDT) contacts	1SVR 405 660 R1100

Accessories for CR-U sockets

CR-UH	Metall holder	1SVR 405 669 R0000
-------	---------------	--------------------

Function modules

Type	Rated control supply voltage U_s	Version	Order code
Diode - Reverse polarity protection			
CR-U 21	6-220 V DC	A1+, A2-	1SVR 405 661 R0000
Diode and LED - Reverse polarity protection			
CR-U 41	6-24 V DC	red, A1+, A2-	1SVR 405 662 R0000
CR-U 41V	6-24 V DC	green, A1+, A2-	1SVR 405 662 R1000
CR-U 41B	24-60 V DC	red, A1+, A2-	1SVR 405 662 R4000
CR-U 41BV	24-60 V DC	green, A1+, A2-	1SVR 405 662 R4100
CR-U 41C	110 V DC	red, A1+, A2-	1SVR 405 662 R9000
CR-U 41CV	110 V DC	green, A1+, A2-	1SVR 405 662 R9100
RC element - Arc elimination			
CR-U 51B	6-24 V AC/DC		1SVR 405 663 R0000
CR-U 51D	24-60 V AC/DC		1SVR 405 663 R4000
CR-U 51C	110-230 V AC/DC		1SVR 405 663 R1000
Diode and LED			
CR-U 61	6-24 V AC/DC	red, for DC: A1+, A2-	1SVR 405 664 R0000
CR-U 61V	6-24 V AC/DC	green, for DC: A1+, A2-	1SVR 405 664 R1000
CR-U 61E	24-60 V AC/DC	red, for DC: A1+, A2-	1SVR 405 664 R4000
CR-U 61EV	24-60 V AC/DC	green, for DC: A1+, A2-	1SVR 405 664 R4100
CR-U 91	110-230 V AC / 110 V DC	red, for DC: A1+, A2-	1SVR 405 664 R0100
CR-U 91V	110-230 V AC / 110 V DC	green, for DC: A1+, A2-	1SVR 405 664 R1100
Varistor and LED - Overvoltage protection			
CR-U 61C	6-24 V AC/DC	red, for DC: A1+, A2-	1SVR 405 665 R0000
CR-U 61CV	6-24 V AC/DC	green, for DC: A1+, A2-	1SVR 405 665 R1000
CR-U 61D	24-60 V AC/DC	red, for DC: A1+, A2-	1SVR 405 665 R4000
CR-U 61DV	24-60 V AC/DC	green, for DC: A1+, A2-	1SVR 405 665 R4100
CR-U 91C	110-230 V AC / 110 V DC	red, for DC: A1+, A2-	1SVR 405 665 R0100
CR-U 91CV	110-230 V AC / 110 V DC	green, for DC: A1+, A2-	1SVR 405 665 R1100
Varistor - Overvoltage protection			
CR-U 71	24 V AC		1SVR 405 666 R0000
CR-U 71A	115 V AC		1SVR 405 666 R1000
CR-U 81	230 V AC		1SVR 405 666 R2000

Multifunction time module

Type	Rated control supply voltage U_s	Order code
Multifunction timer module		
CR-U T	24-240 V AC/DC	pluggable onto CR-U2S and CR-U3S
		1SVR 405 667 R0000

All CR-U modules can be plugged onto sockets CR-U2S and CR-U3S.

Functions

Operating controls

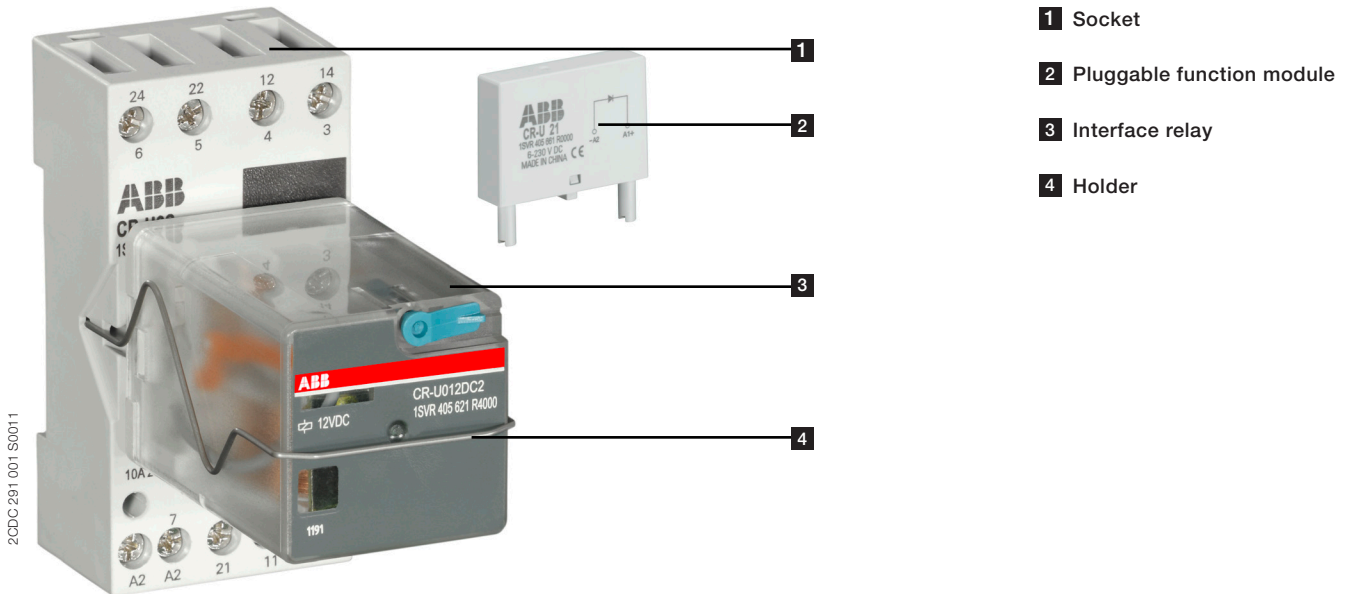

Application

Interface relays are electromechanic and electronic input and output modules for electrical isolation, levelling, noise suppression or signal amplification between control unit and process.

Operating mode

When control supply voltage is applied, the output contacts get closed. When control supply voltage is switched off, the contacts fall back into their starting position. Manual operation and locking of the output relays is possible via the integrated test button.

Note:

During operation of the relay the test button is warming up. To manually press the test button, first switch off the supply voltage of the relay and wait for a while until the button cools down (or press without delay, using protective gloves or insulated tools).

Press the button smoothly and quickly. As long as the button is pressed the n/o contacts are closed. Releasing the button opens the n/o contacts. A 90 degree rotation of the test button closes the n/o contacts permanently. Reverse rotation of the test button re-opens the n/o contacts.

Electrical connection

CR-U with 2 c/o (SPDT) contacts

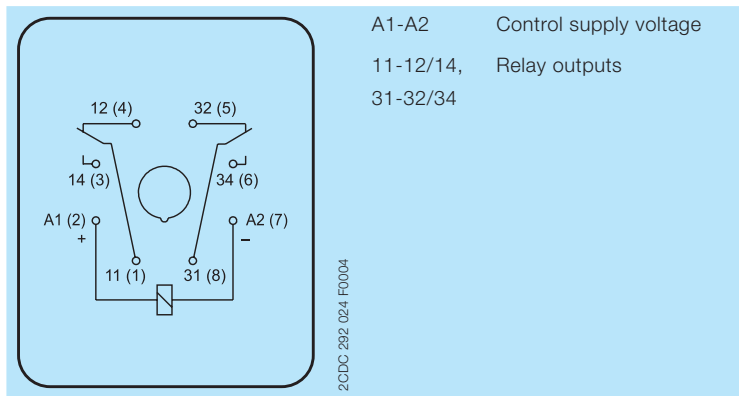

Connection diagram

CR-U with 3 c/o (SPDT) contacts

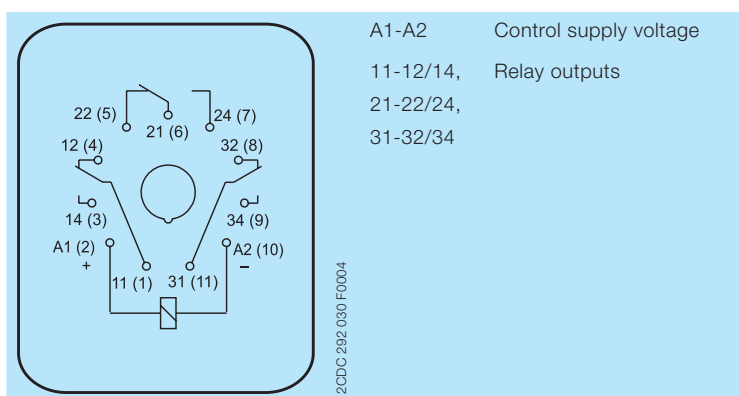

Connection diagram

Technical data

Input circuit - Coil data A1-A2

	Rated control supply voltage U_s	Rated frequency	Make voltage (at 20 °C)	Maxium voltage (at 55 °C)	Break voltage	Rated power	Coil resistance (at 20 °C)	Tolerance of coil resistance
DC coils	12 V DC	-	9.6 V DC	13.2 V DC	$\geq 0.1 U_s$	1,5 W	110 Ω	$\pm 10 \%$
	24 V DC	-	19.2 V DC	26.4 V DC	$\geq 0.1 U_s$	1,5 W	430 Ω	$\pm 10 \%$
	48 V DC	-	38.4 V DC	52.8 V DC	$\geq 0.1 U_s$	1,5 W	1750 Ω	$\pm 10 \%$
	110 V DC	-	88.0 V DC	121.0 V DC	$\geq 0.1 U_s$	1,5 W	9200 Ω	$\pm 10 \%$
	125 V DC	-	100 V DC	137.5 V DC	$\geq 0.1 U_s$	1,5 W	11000 Ω	$\pm 10 \%$
	220 V DC	-	176.0 V DC	242.0 V DC	$\geq 0.1 U_s$	1,5 W	37000 Ω	$\pm 10 \%$
AC Coils	24 V AC	50/60 Hz	19.2 V AC	26.4 V AC	$\geq 0.15 U_s$	2,8 VA (50 Hz) 2,5 VA (60 Hz)	75 Ω	$\pm 10 \%$
	48 V AC	50/60 Hz	38.4 V AC	52.8 V AC	$\geq 0.15 U_s$	2,8 VA (50 Hz) 2,5 VA (60 Hz)	305 Ω	$\pm 10 \%$
	60 V AC	50/60 Hz	48.0 V AC	66.0 V AC	$\geq 0.15 U_s$	2,8 VA (50 Hz) 2,5 VA (60 Hz)	475 Ω	$\pm 10 \%$
	110 V AC	50/60 Hz	88.0 V AC	121.0 V AC	$\geq 0.15 U_s$	2,8 VA (50 Hz) 2,5 VA (60 Hz)	1700 Ω	$\pm 10 \%$
	120 V AC	50/60 Hz	96.0 V AC	132.0 V AC	$\geq 0.15 U_s$	2,8 VA (50 Hz) 2,5 VA (60 Hz)	1910 Ω	$\pm 10 \%$
	230 V AC	50/60 Hz	184.0 V AC	253.0 V AC	$\geq 0.15 U_s$	2,8 VA (50 Hz) 2,5 VA (60 Hz)	7080 Ω	$\pm 10 \%$

Output circuits

Type		CR-U...2	CR-U...3
Output circuits		11-12/14, 31-32/34	11-12/14, 21-22/24, 31-32/34
Kind of output		relays, 2 c/o (SPDT) contacts	relays, 3 c/o (SPDT) contacts
Contact material		AgNi	
Rated operational voltage U_o (IEC/EN 60947-1)		250 V	
Minimum switching voltage		10 V	
Maximum switching voltage		250 V DC / 440 V AC	
Minimum switching current		5 mA	
Rated free air thermal current I_{th}		10 A	
Rated operational current (IEC/EN 60947-5-1)	AC-12 (resistive)	230 V	10 A
	AC-15 (inductive)	230 V	1.5 A
	AC-15 (inductive)	120 V	3 A
	DC-12 (resistive)	24 V	10 A
	DC-13 (inductive)	24 V	2 A
	DC-13 (inductive)	120 V	0.22 A
	DC-13 (inductive)	250 V	0.1 A
AC rating * (UL 508; NEMA ICS-5)	Utilization category (pilot duty) (Contact rating code designation)		B300
	Max. rated operational voltage		300 V AC
	Max. continuous thermal current at utilization category		5 A
	Max. making / breaking apparent power at utilization category		3600 / 360 VA
	Utilization category General Purpose (single-phase)		10 A, 250 V AC
	Utilization category (resistive) (CSA22.2 No.14...)		10 A, 250 V AC
DC rating * (UL 508; NEMA ICS-5)	Utilization category (pilot duty) (Contact rating code designation)		R300
	Max. rated operational voltage		300 V DC
	Max. continuous thermal current at utilization category		1 A
	Max. making / breaking apparent power at utilization category		28 VA
	Utilization category (resistive) (CSA22.2 No.14...)		10 A, 28 V DC
	Maximum making (inrush) current		20 A
Minimum switching power		0.3 W	
Maximum switching (breaking) power	AC-1 (resistive)		2500 VA
Contact resistance			$\leq 100 \text{ m}\Omega$
Maximum operating frequency	rated load AC-1		1200 switching cycles / h
	without load		12000 switching cycles / h
Mechanical lifetime			$> 2 \times 10^7$ switching cycles / h
Electrical lifetime	AC-1 (resistive)		$> 10^9$ switching cycles (12 A, 250 V)
	$\cos \varphi$		See reduction factor F
Response time			typ. 18 ms (DC), typ. 12 ms (AC)
Release time			typ. 7 ms (DC), typ. 10 ms (AC)

*) Those ratings are based on different type tests but they are not covered by the cULus or CSA approvals

Isolation data

Type	CR-U...2	CR-U...3
Rated insulation voltage	250 V AC	
Insulation class	C250	
Rated impulse withstand voltage U_{imp}	between coil and contacts	2.5 kV
	between open contacts	1.5 kV
	between c/o (SPDT) contacts	2 kV
Clearance	between coil and contacts ≥ 3 mm	
Creepage distance	between coil and contacts ≥ 4.2 mm	
Overvoltage category	III	
Pollution degree	3	

General data

Type	CR-U...2	CR-U...3
Dimensions (W x H x D) when mounted	35 x 35 x 54.4 mm (1.378 x 1.378 x 2.142 in)	
Weight	83 g (0.18 lb)	
Mounting	on socket (see accessories)	
Mounting position	any	
Degree of protection	IP 40	

Electrical data

Type	CR-U...2	CR-U...3
Connection	by socket	

Environmental data

Type	CR-U...2	CR-U...3
Ambient temperature range	operation	DC: -40...+70 °C; AC: -40...+55 °C
	storage	-40...+85 °C
Vibration resistance (10-150 Hz)	n/o contact	5 g
	n/c contact	5 g
Shock resistance	n/o contact	10 g
	n/c contact	10 g

Standards / Directives

Type	CR-U...2	CR-U...3
Standards	IEC/EN 61810-1	
Low Voltage Directive	2014/35/EU	
RoHS Directive	2011/65/EU	

Technical diagrams

Load limit curve -
Maximum switching power at resistive load

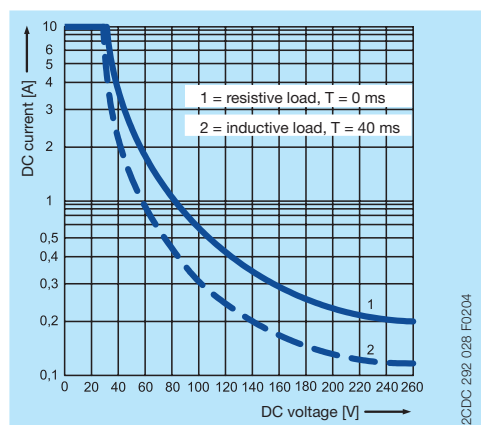

Load limit curve -
Electrical lifetime at resistive AC load

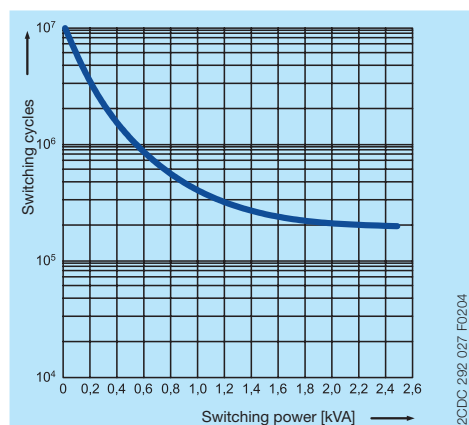

Reduction factor F at inductive AC load

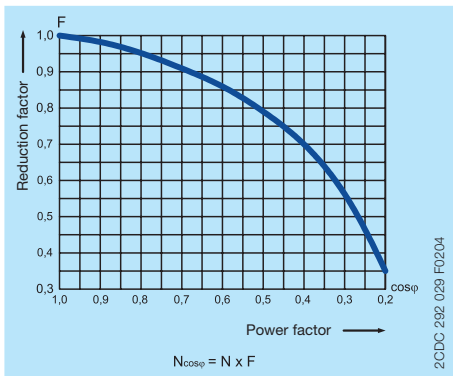

Dimensions

in mm

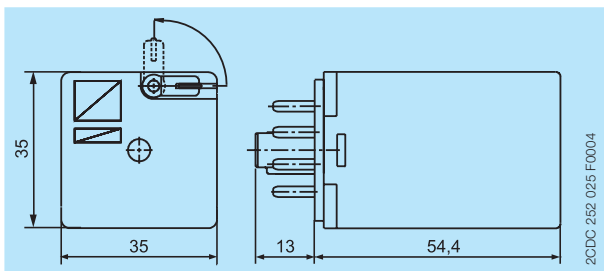

Versions with 2 c/o (SPDT) contacts (CR-U ... 2)

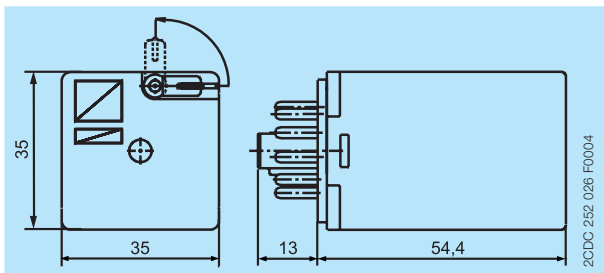

Versions with 3 c/o (SPDT) contacts (CR-U ... 3)

Further documentation

Document title	Document type	Document number
Electronic Products and Relays	Technical catalogue	2CDC 110 004 C02xx
Sockets CR-U	Data sheet	2CDC 117 006 D020x
Pluggable function modules CR-U	Data sheet	2CDC 117 008 D020x
Pluggable multifunction time module CR-U T	Data sheet	2CDC 117 010 D020x

You can find the documentation on the internet at www.abb.com/lowvoltage

-> Automation, control and protection -> Electronic relays and controls

-> Interface relays and optocouplers.

CAD system files

You can find the CAD files for CAD systems at <http://abb-control-products.partcommunity.com>

-> Low Voltage Products & Systems -> Control Products -> Electronic Relays and Controls.

Contact us

ABB STOTZ-KONTAKT GmbH

P. O. Box 10 16 80
69006 Heidelberg, Germany
Phone: +49 (0) 6221 7 01-0
Fax: +49 (0) 6221 7 01-13 25
E-mail: info.desto@de.abb.com

You can find the address of your
local sales organization on the
ABB home page
<http://www.abb.com/contacts>
-> Low Voltage Products and Systems

Note:

We reserve the right to make technical changes or modify the contents of this document without prior notice. With regard to purchase orders, the agreed particulars shall prevail. ABB AG does not accept any responsibility whatsoever for potential errors or possible lack of information in this document.

We reserve all rights in this document and in the subject matter and illustrations contained therein. Any reproduction, disclosure to third parties or utilization of its contents – in whole or in parts – is forbidden without prior written consent of ABB AG.

Copyright© 2016 ABB
All rights reserved

X-ON Electronics

Largest Supplier of Electrical and Electronic Components

Click to view similar products for [ABB manufacturer:](#)

Other Similar products are found below :

[TY27MX](#) [TV10-516R](#) [RF727](#) [2CMA100178R1000](#) [ACS150-01E-09A8-2](#) [KS70-1104](#) [A75-30-11-230V-50HZ](#) [10-100](#) [5SDD](#) [92Z0401](#)
[ESV14-BS](#) [EZS-21-250](#) [F204AC-40/0.1](#) [F362-25/0.03](#) [A40-30-10-84](#) [AF26-30-00-14](#) [AF30-30-00-13](#) [AF460-30-11-68](#) [AF50-30-11-70](#)
[1455](#) [B14-250](#) [EF45-30](#) [ERG297](#) [HSC2-20](#) [1SAM201904R1001](#) [1SAM350000R1003](#) [1SAZ711201R1045](#) [1SAZ721201R1009](#)
[1SAZ721201R1014](#) [1SAZ721201R1025](#) [1SAZ721201R1045](#) [1SBL367001R1300](#) [1SDA057197R1](#) [1SFA611100R1104](#) [1SFA611101R1002](#)
[1SFA611130R1103](#) [1SFA611133R1106](#) [1SFA611143R1101](#) [1SFA611202R1108](#) [1SFA611203R1108](#) [1SFA611210R1101](#)
[1SFA611215R1001](#) [1SFA611216R1108](#) [1SFA611281R1002](#) [1SFA611285R1002](#) [1SFA611702R6006](#) [1SFA616162R1025](#)
[1SFA896106R1100](#) [1SVR730020R0200](#) [IPC4111](#) [OHB125J12](#)