

Printed-circuit board connector - TFKC 2,5/ 2-ST-5,08 - 1962600

Please be informed that the data shown in this PDF Document is generated from our Online Catalog. Please find the complete data in the user's documentation. Our General Terms of Use for Downloads are valid (<http://phoenixcontact.com/download>)

Plug component, nominal current: 12 A, rated voltage (III/2): 320 V, number of positions: 2, pitch: 5.08 mm, connection method: Push-in spring connection, Color: green, contact surface: Tin

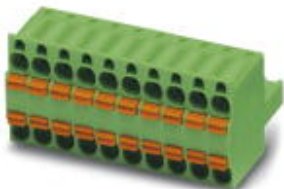

The figure shows a 10-position version of the product

Why buy this product

- Time saving push-in connection, tools not required
- Potentials can be easily looped through – ideal for BUS applications
- Intuitive use through colour coded actuation lever
- Can be combined with the MSTB 2,5 range
- Quick and convenient testing using integrated test option



Key Commercial Data

| | |
|--------------------------------------|---|
| Packing unit | 50 STK |
| Minimum order quantity | 50 STK |
| GTIN |  4 017918 912031 |
| GTIN | 4017918912031 |
| Weight per Piece (excluding packing) | 4.580 g |
| Custom tariff number | 85366990 |
| Country of origin | Bulgaria |

Technical data

Dimensions

| | |
|--------------|----------|
| Length [l] | 25.7 mm |
| Width [w] | 10.06 mm |
| Height [h] | 22.1 mm |
| Pitch | 5.08 mm |
| Dimension a | 5.08 mm |

General

Printed-circuit board connector - TFKC 2,5/ 2-ST-5,08 - 1962600

Technical data

General

| | |
|--|---------------------------|
| Range of articles | TFKC 2,5/...-ST |
| Type of contact | Female connector |
| Number of positions | 2 |
| Connection method | Push-in spring connection |
| Insulating material group | I |
| Rated surge voltage (III/3) | 4 kV |
| Rated surge voltage (III/2) | 4 kV |
| Rated surge voltage (II/2) | 4 kV |
| Rated voltage (III/3) | 320 V |
| Rated voltage (III/2) | 320 V |
| Rated voltage (II/2) | 630 V |
| Connection in acc. with standard | EN-VDE |
| Nominal current I_N | 12 A |
| Nominal cross section | 2.5 mm ² |
| Maximum load current | 12 A |
| Insulating material | PA |
| Flammability rating according to UL 94 | V0 |
| Stripping length | 10 mm |

Connection data

| | |
|---|----------------------|
| Conductor cross section solid min. | 0.2 mm ² |
| Conductor cross section solid max. | 2.5 mm ² |
| Conductor cross section flexible min. | 0.2 mm ² |
| Conductor cross section flexible max. | 2.5 mm ² |
| Conductor cross section flexible, with ferrule without plastic sleeve min. | 0.25 mm ² |
| Conductor cross section flexible, with ferrule without plastic sleeve max. | 2.5 mm ² |
| Conductor cross section flexible, with ferrule with plastic sleeve min. | 0.25 mm ² |
| Conductor cross section flexible, with ferrule with plastic sleeve max. | 2.5 mm ² |
| Conductor cross section AWG min. | 24 |
| Conductor cross section AWG max. | 12 |
| 2 conductors with same cross section, stranded, TWIN ferrules with plastic sleeve, min. | 0.5 mm ² |
| 2 conductors with same cross section, stranded, TWIN ferrules with plastic sleeve, max. | 1 mm ² |
| Minimum AWG according to UL/CUL | 26 |
| Maximum AWG according to UL/CUL | 12 |

Standards and Regulations

| | |
|--|--------|
| Connection in acc. with standard | EN-VDE |
| | CUL |
| Flammability rating according to UL 94 | V0 |

Environmental Product Compliance

Printed-circuit board connector - TFKC 2,5/ 2-ST-5,08 - 1962600

Technical data

Environmental Product Compliance

| | |
|------------|---|
| China RoHS | Environmentally friendly use period: unlimited = EFUP-e |
| | No hazardous substances above threshold values |

Drawings

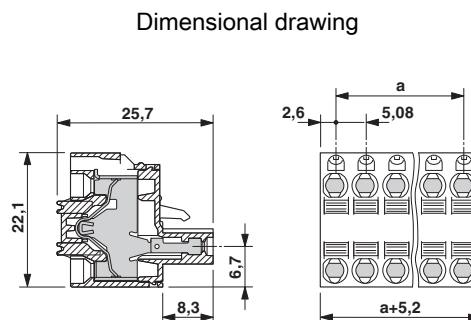
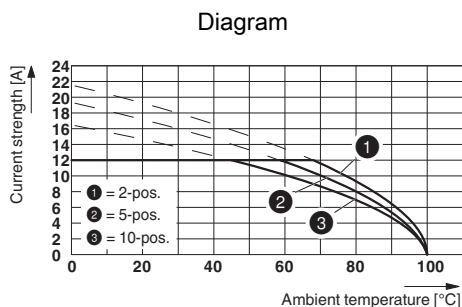

Type: TFKC 2,5/...-ST-5,08 with MSTBVA 2,5/...-G-5,08

Classifications

eCl@ss

| | |
|------------|----------|
| eCl@ss 4.0 | 272607xx |
| eCl@ss 4.1 | 27260701 |
| eCl@ss 5.0 | 27260701 |
| eCl@ss 5.1 | 27260701 |
| eCl@ss 6.0 | 27260704 |
| eCl@ss 7.0 | 27440402 |
| eCl@ss 8.0 | 27440309 |
| eCl@ss 9.0 | 27440309 |

ETIM

| | |
|----------|----------|
| ETIM 3.0 | EC001121 |
| ETIM 4.0 | EC002638 |
| ETIM 5.0 | EC002638 |
| ETIM 6.0 | EC002638 |

UNSPSC

| | |
|---------------|----------|
| UNSPSC 6.01 | 30211810 |
| UNSPSC 7.0901 | 39121409 |
| UNSPSC 11 | 39121409 |
| UNSPSC 12.01 | 39121409 |
| UNSPSC 13.2 | 39121409 |

Printed-circuit board connector - TFKC 2,5/ 2-ST-5,08 - 1962600

Approvals

Approvals

Approvals

VDE Gutachten mit Fertigungsüberwachung / IECCEB Scheme / cULus Recognized / EAC

Ex Approvals

Approval details

| | | | |
|---|---|---|----------|
| VDE Gutachten mit Fertigungsüberwachung |  | http://www.vde.com/en/Institute/OnlineService/VDE-approved-products/Pages/Online-Search.aspx | 40004701 |
| mm ² /AWG/kcmil | 0.2-2.5 | | |
| Nominal current I _N | 12 A | | |
| Nominal voltage U _N | 250 V | | |

| | | | |
|--------------------------------|---|---|----------------|
| IECEE CB Scheme |  | http://www.iecee.org/ | DE1-58978-B1B2 |
| mm ² /AWG/kcmil | 0.2-2.5 | | |
| Nominal current I _N | 12 A | | |
| Nominal voltage U _N | 250 V | | |

| | | | |
|--------------------------------|---|---|-----------------|
| cULus Recognized |  | http://database.ul.com/cgi-bin/XYV/template/LISEXT/1FRAME/index.htm | E60425-19931011 |
| | B | D | |
| mm ² /AWG/kcmil | 26-12 | 26-12 | |
| Nominal current I _N | 10 A | 10 A | |
| Nominal voltage U _N | 300 V | 300 V | |

| | | |
|-----|---|---------|
| EAC |  | B.01742 |
|-----|---|---------|

Accessories

Accessories

Coding element

Printed-circuit board connector - TFKC 2,5/ 2-ST-5,08 - 1962600

Accessories

Coding profile - CP-MSTB - 1734634

Coding profile, is inserted into the slot on the plug or inverted header, red insulating material



Insulating sleeve

Insulating sleeve - MPS-IH WH - 0201663

Insulating sleeve, color: white



Insulating sleeve - MPS-IH RD - 0201676

Insulating sleeve, color: red



Insulating sleeve - MPS-IH BU - 0201689

Insulating sleeve, color: blue



Labeled terminal marker

Marker card - SK 5,08/2,8:FORTL.ZAHLEN - 0804280



Marker card, Card, white, labeled, Horizontal: Consecutive numbers 1 - 10, 11 - 20, etc. up to 91 - (99)100, Mounting type: adhesive, for terminal block width: 5.08 mm, Lettering field: 5.08 x 2.8 mm

Marker pen

Printed-circuit board connector - TFKC 2,5/ 2-ST-5,08 - 1962600

Accessories

Marker pen - B-STIFT - 1051993



Marker pen, for manual labeling of unprinted Zack strips, smear-proof and waterproof, line thickness 0.5 mm

Screwdriver tools

Screwdriver - SZS 0,6X3,5 - 1205053



Actuation tool, for ST terminal blocks, insulated, also suitable for use as a bladed screwdriver, size: 0.6 x 3.5 x 100 mm, 2-component grip, with non-slip grip

Terminal marking

Marker card - SK U/2,8 WH:UNBEDRUCKT - 0803883



Marker card, Sheet, white, unlabeled, can be labeled with: CMS-P1-PLOTTER, PLOTMARK, Office printing systems, Mounting type: adhesive, for terminal block width: 210 mm, Lettering field: 186 x 2.8 mm

Test plug terminal block

Reducing plug - RPS - 0201647



Reducing plug, color: gray

Additional products

Housing - MSTBW 2,5/ 2-G-5,08 - 1735882



Header, nominal current: 12 A, rated voltage (III/2): 320 V, number of positions: 2, pitch: 5.08 mm, Color: green, contact surface: Tin, mounting: Wave soldering

Printed-circuit board connector - TFKC 2,5/ 2-ST-5,08 - 1962600

Accessories

Base strip - MSTBVA 2,5/ 2-G-5,08 - 1755736



Header, nominal current: 12 A, rated voltage (III/2): 320 V, number of positions: 2, pitch: 5.08 mm, Color: green, contact surface: Tin, mounting: Wave soldering

Base strip - MSTBA 2,5/ 2-G-5,08 - 1757242



Header, nominal current: 12 A, rated voltage (III/2): 320 V, number of positions: 2, pitch: 5.08 mm, Color: green, contact surface: Tin, mounting: Wave soldering

Base strip - MSTBV 2,5/ 2-G-5,08 - 1758018



Header, nominal current: 12 A, rated voltage (III/2): 320 V, number of positions: 2, pitch: 5.08 mm, Color: green, contact surface: Tin, mounting: Wave soldering

Base strip - MSTB 2,5/ 2-G-5,08 - 1759017



Header, nominal current: 12 A, rated voltage (III/2): 320 V, number of positions: 2, pitch: 5.08 mm, Color: green, contact surface: Tin, mounting: Wave soldering

Base strip - MDSTB 2,5/ 2-G-5,08 - 1762062



Header, nominal current: 10 A, rated voltage (III/2): 320 V, number of positions: 2, pitch: 5.08 mm, Color: green, contact surface: Tin, mounting: Wave soldering, Can be aligned! Mounting flange: Order no. 1736771, 1736768. In combination with MVSTB or FKCV plugs, both an MVSTBW (or FKCVW) and an MVSTBR plug (or FKCVR) must be used. Combination with TMSTBP plugs is not possible!

Printed-circuit board connector - TFKC 2,5/ 2-ST-5,08 - 1962600

Accessories

Base strip - MDSTBV 2,5/ 2-G-5,08 - 1763074



Header, nominal current: 10 A, rated voltage (III/2): 320 V, number of positions: 2, pitch: 5.08 mm, Color: green, contact surface: Tin, mounting: Wave soldering, Can be aligned! Mounting flange: Order No. 1836477, 1836480. In combination with MVSTB or FKCV plug components, both an MVSTBW (or FKCVW) and an MVSTBR plug (or FKCVR) must be used. Combination with TMSTBP plug components is not possible!

Base strip - SMSTBA 2,5/ 2-G-5,08 - 1767371



Header, nominal current: 12 A, rated voltage (III/2): 320 V, number of positions: 2, pitch: 5.08 mm, Color: green, contact surface: Tin, mounting: Wave soldering

Base strip - SMSTB 2,5/ 2-G-5,08 - 1769463



Header, nominal current: 12 A, rated voltage (III/2): 320 V, number of positions: 2, pitch: 5.08 mm, Color: green, contact surface: Tin, mounting: Wave soldering

Base strip - MSTBA 2,5/ 2-G-5,08-LA - 1770944



Header, nominal current: 12 A, rated voltage (III/2): 320 V, number of positions: 2, pitch: 5.08 mm, Color: green, contact surface: Tin, mounting: Wave soldering

Base strip - MDSTBW 2,5/ 2-G-5,08 - 1802430



Header, nominal current: 10 A, rated voltage (III/2): 320 V, number of positions: 2, pitch: 5.08 mm, Color: green, contact surface: Tin, mounting: Wave soldering, The article can be aligned to create different nos. of positions! In combination with MVSTB or FKCV plug components, both an MVSTBW (or FKCVW) and an MVSTBR plug (or FKCVR) must be used. Combination with TMSTBP plug components is not possible!

Printed-circuit board connector - TFKC 2,5/ 2-ST-5,08 - 1962600

Accessories

Base strip - MDSTBA 2,5/ 2-G-5,08 - 1842063



Header, nominal current: 10 A, rated voltage (III/2): 320 V, number of positions: 2, pitch: 5.08 mm, Color: green, contact surface: Tin, mounting: Wave soldering, The article can be aligned to create different nos. of positions! In combination with MVSTB or FKCV plug components, both an MVSTBW (or FKCVW) and an MVSTBR plug (or FKCVR) must be used. Combination with TMSTBP plug components is not possible!

Base strip - MDSTBVA 2,5/ 2-G-5,08 - 1845332



Header, nominal current: 10 A, rated voltage (III/2): 320 V, number of positions: 2, pitch: 5.08 mm, Color: green, contact surface: Tin, mounting: Wave soldering, The article can be aligned to create different nos. of positions! In combination with MVSTB or FKCV plug components, both an MVSTBW (or FKCVW) and an MVSTBR plug (or FKCVR) must be used. Combination with TMSTBP plug components is not possible!

Base strip - EMSTBVA 2,5/ 2-G-5,08 - 1859519



Header, nominal current: 12 A, rated voltage (III/2): 320 V, number of positions: 2, pitch: 5.08 mm, Color: green, contact surface: Tin, mounting: Press-in technology

Base strip - MDSTBA 2,5/ 2-GL-5,08 - 1877601



Header, nominal current: 10 A, rated voltage (III/2): 320 V, number of positions: 2, pitch: 5.08 mm, Color: green, contact surface: Tin, mounting: Wave soldering, The article can be aligned to create different nos. of positions! In combination with MVSTB or FKCV plug components, both an MVSTBW (or FKCVW) and an MVSTBR plug (or FKCVR) must be used. Combination with TMSTBP plug components is not possible!

Base strip - MDSTBA 2,5/ 2-GR-5,08 - 1877614

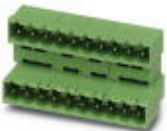

Header, nominal current: 10 A, rated voltage (III/2): 320 V, number of positions: 2, pitch: 5.08 mm, Color: green, contact surface: Tin, mounting: Wave soldering, The article can be aligned to create different nos. of positions! In combination with MVSTB or FKCV plug components, both an MVSTBW (or FKCVW) and an MVSTBR plug (or FKCVR) must be used. Combination with TMSTBP plug components is not possible!

Printed-circuit board connector - TFKC 2,5/ 2-ST-5,08 - 1962600

Accessories

Base strip - MDSTBVA 2,5/ 2-GL-5,08 - 1877627



Header, nominal current: 10 A, rated voltage (III/2): 320 V, number of positions: 2, pitch: 5.08 mm, Color: green, contact surface: Tin, mounting: Wave soldering, The article can be aligned to create different nos. of positions! In combination with MVSTB or FKCV plug components, both an MVSTBW (or FKCVW) and an MVSTBR plug (or FKCVR) must be used. Combination with TMSTBP plug components is not possible!

Housing - MDSTBVA 2,5/ 2-GR-5,08 - 1877630



Header, nominal current: 10 A, rated voltage (III/2): 320 V, number of positions: 2, pitch: 5.08 mm, Color: green, contact surface: Tin, mounting: Wave soldering, The article can be aligned to create different nos. of positions! In combination with MVSTB or FKCV plug components, both an MVSTBW (or FKCVW) and an MVSTBR plug (or FKCVR) must be used. Combination with TMSTBP plug components is not possible!

Base strip - EMSTBA 2,5/ 2-G-5,08 - 1880300



Header, nominal current: 12 A, rated voltage (III/2): 320 V, number of positions: 2, pitch: 5.08 mm, Color: green, contact surface: Tin, mounting: Press-in technology

Base strip - DFK-MSTBA 2,5/ 2-G-5,08 - 1898839



Header, nominal current: 12 A, rated voltage (III/2): 320 V, number of positions: 2, pitch: 5.08 mm, Color: green, contact surface: Tin, mounting: Wave soldering

Base strip - DFK-MSTBVA 2,5/ 2-G-5,08 - 1899139



Header, nominal current: 12 A, rated voltage (III/2): 320 V, number of positions: 2, pitch: 5.08 mm, Color: green, contact surface: Tin, mounting: Wave soldering

Printed-circuit board connector - TFKC 2,5/ 2-ST-5,08 - 1962600

Accessories

Printed-circuit board connector - MSTBA 2,5/ 2-G-5,08 THT - 1902741



Header, nominal current: 12 A, rated voltage (III/2): 320 V, number of positions: 2, pitch: 5.08 mm, Color: black, contact surface: Tin, mounting: THR soldering, User information and design recommendations for through hole reflow technology can be found under "Downloads"

Base strip - MSTBVA 2,5/ 2-G-5,08 THT - 1902819



Header, nominal current: 12 A, rated voltage (III/2): 320 V, number of positions: 2, pitch: 5.08 mm, Color: black, contact surface: Tin, mounting: THR soldering, User information and design recommendations for through hole reflow technology can be found under "Downloads"

Printed-circuit board connector - MSTBA 2,5/ 2-G-5,08 THT-R32 - 1937237



Header, nominal current: 12 A, rated voltage (III/2): 320 V, number of positions: 2, pitch: 5.08 mm, Color: black, contact surface: Tin, mounting: THR soldering, User information and design recommendations for through hole reflow technology can be found under "Downloads"

Base strip - MSTBVA 2,5/ 2-G-5,08 THT-R56 - 1940415



Header, nominal current: 12 A, rated voltage (III/2): 320 V, number of positions: 2, pitch: 5.08 mm, Color: black, contact surface: Tin, mounting: THR soldering, User information and design recommendations for through hole reflow technology can be found under "Downloads"

Printed-circuit board connector - CC 2,5/ 2-G-5,08 P26THR - 1954388



Header, nominal current: 12 A, rated voltage (III/2): 320 V, number of positions: 2, pitch: 5.08 mm, Color: black, contact surface: Tin, mounting: THR soldering, User information and design recommendations for through hole reflow technology can be found under "Downloads"

Printed-circuit board connector - TFKC 2,5/ 2-ST-5,08 - 1962600

Accessories

Printed-circuit board connector - CC 2,5/ 2-G-5,08 P26THRR32 - 1954582



Header, nominal current: 12 A, rated voltage (III/2): 320 V, number of positions: 2, pitch: 5.08 mm, Color: black, contact surface: Tin, mounting: THR soldering, User information and design recommendations for through hole reflow technology can be found under "Downloads"

Printed-circuit board connector - CCA 2,5/ 2-G-5,08 P26THR - 1954919



Header, nominal current: 12 A, rated voltage (III/2): 320 V, number of positions: 2, pitch: 5.08 mm, connection method: Plug connection, Color: black, contact surface: Tin, mounting: THR soldering, User information and design recommendations for through hole reflow technology can be found under "Downloads"

Printed-circuit board connector - CCA 2,5/ 2-G-5,08 P26THRR32 - 1955031



Header, nominal current: 12 A, rated voltage (III/2): 320 V, number of positions: 2, pitch: 5.08 mm, Color: black, contact surface: Tin, mounting: THR soldering, User information and design recommendations for through hole reflow technology can be found under "Downloads"

Printed-circuit board connector - CCV 2,5/ 2-G-5,08 P26THR - 1955387



Header, nominal current: 12 A, rated voltage (III/2): 320 V, number of positions: 2, pitch: 5.08 mm, Color: black, contact surface: Tin, mounting: THR soldering, User information and design recommendations for through hole reflow technology can be found under "Downloads"

Printed-circuit board connector - CCV 2,5/ 2-G-5,08 P26THRR32 - 1955523



Header, nominal current: 12 A, rated voltage (III/2): 320 V, number of positions: 2, pitch: 5.08 mm, Color: black, contact surface: Tin, mounting: THR soldering, User information and design recommendations for through hole reflow technology can be found under "Downloads"

Printed-circuit board connector - TFKC 2,5/ 2-ST-5,08 - 1962600

Accessories

Printed-circuit board connector - CCVA 2,5/ 2-G-5,08 P26THR - 1955853

Header, nominal current: 12 A, rated voltage (III/2): 320 V, number of positions: 2, pitch: 5.08 mm, Color: black, contact surface: Tin, mounting: THR soldering, User information and design recommendations for through hole reflow technology can be found under "Downloads"



Printed-circuit board connector - CCVA 2,5/ 2-G-5,08 P26THRR32 - 1955963

Header, nominal current: 12 A, rated voltage (III/2): 320 V, number of positions: 2, pitch: 5.08 mm, Color: black, contact surface: Tin, mounting: THR soldering, User information and design recommendations for through hole reflow technology can be found under "Downloads"



X-ON Electronics

Largest Supplier of Electrical and Electronic Components

Click to view similar products for [Phoenix Contact](#) manufacturer:

Other Similar products are found below :

[1212619](#) [3240366](#) [1893300](#) [1401029](#) [1773093](#) [2814045](#) [2989433](#) [2963886](#) [2966537](#) [2313944](#) [2834546](#) [2834407](#) [1687312](#) [3056145](#)
[1775619](#) [1618261](#) [1674998](#) [2858894](#) [443023](#) [2905235](#) [2833547](#) [3240098](#) [2905234](#) [FFKDS/V-2.54](#) [0201391](#) [0201595](#) [7001438](#)
[MICROFOX-R](#) [PLC-RSP- 24DC/21-21](#) [PR1-RSC3-LDP-24DC/21](#) [PR1-RSC3-LV-120AC/2X21](#) [PSI-MOS-DNET CAN/FO 660/BM](#) [PSM-](#)
[SET-FSMA/4-KT](#) [PSR-SCF-120UC/URM/2X21](#) [PT 4-DIO 1N 5408/L-R](#) [PT 4-FSI/F-LED 12](#) [1202580](#) [1203534](#) [1205985](#) [1206308](#) [1201798](#)
[1207420](#) [1207886](#) [1208461](#) [1208843](#) [1206188](#) [1212066](#) [1212096](#) [1212171](#) [1212250](#)