



WTB9-3P2261

W9-3

PHOTOELECTRIC SENSORS

SICK
Sensor Intelligence.



Illustration may differ



Ordering information

Type	Part no.
WTB9-3P2261	1049047

Other models and accessories → www.sick.com/W9-3

Detailed technical data

Features

Sensor/detection principle	Photoelectric proximity sensor, Background suppression
Dimensions (W x H x D)	12.2 mm x 49.8 mm x 23.6 mm
Housing design (light emission)	Rectangular
Mounting hole	M3
Sensing range max.	20 mm ... 350 mm ¹⁾
Sensing range	20 mm ... 200 mm ²⁾
Type of light	Visible red light
Light source	PinPoint LED ³⁾
Light spot size (distance)	Ø 4.5 mm (75 mm)
Wave length	650 nm
Adjustment	Potentiometer, 5 turns

¹⁾ Object with 90 % reflectance (referred to standard white, DIN 5033).

²⁾ Object with 6 % reflectance (referred to standard white, DIN 5033).

³⁾ Average service life: 100,000 h at T_J = +25 °C.

Mechanics/electronics

Supply voltage	10 V DC ... 30 V DC ¹⁾
Ripple	< 5 V _{pp} ²⁾
Power consumption	≤ 30 mA ³⁾
Output type	PNP ⁴⁾
Output function	Complementary
Switching mode	Light/dark switching ⁴⁾
Output current I_{max.}	≤ 100 mA ⁵⁾
Response time	< 0.333 ms ⁶⁾
Switching frequency	1,500 Hz ⁷⁾
Connection type	Connector M8, 4-pin
Circuit protection	A ⁸⁾ B ⁹⁾ C ¹⁰⁾
Protection class	III
Weight	13 g
Housing material	Plastic, VISTAL®, Plastic, PMMA
Optics material	Plastic, PMMA
Enclosure rating	IP66 IP67 IP69K
Ambient operating temperature	-40 °C ... +60 °C
Ambient storage temperature	-40 °C ... +75 °C
UL File No.	NRKH.E181493

¹⁾ Limit values when operated in short-circuit protected network: max. 8 A.

²⁾ May not exceed or fall below U_v tolerances.

³⁾ Without load.

⁴⁾ Q = light switching.

⁵⁾ At and above Tu 50 °C, a max. load current of I_{max.} = 50 mA is permitted.

⁶⁾ Signal transit time with resistive load.

⁷⁾ With light/dark ratio 1:1.

⁸⁾ A = V_S connections reverse-polarity protected.

⁹⁾ B = inputs and output reverse-polarity protected.

¹⁰⁾ C = interference suppression.

Classifications

ECl@ss 5.0	27270904
ECl@ss 5.1.4	27270904
ECl@ss 6.0	27270904
ECl@ss 6.2	27270904
ECl@ss 7.0	27270904
ECl@ss 8.0	27270904
ECl@ss 8.1	27270904
ECl@ss 9.0	27270904
ETIM 5.0	EC002719

ETIM 6.0	EC002719
UNSPSC 16.0901	39121528

Adjustments possible

Potentiometer

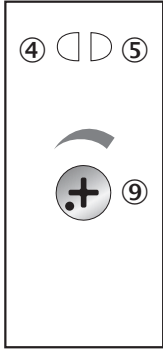

- ④ LED indicator yellow: Status of received light beam
- ⑤ LED indicator green: power on
- ⑨ Adjustment of sensing range

Connection diagram

Cd-084

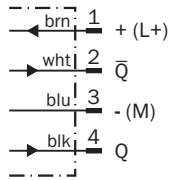

Characteristic curve

WTB9-3, red light, 350 mm

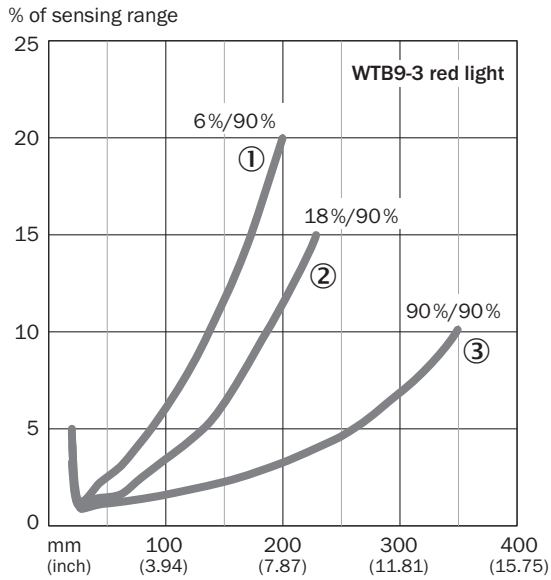

- ① Sensing range on black, 6% remission
- ② Sensing range on gray, 18 % remission
- ③ Sensing range on white, 90% remission

Light spot size

WTB9-3, red light, 350 mm

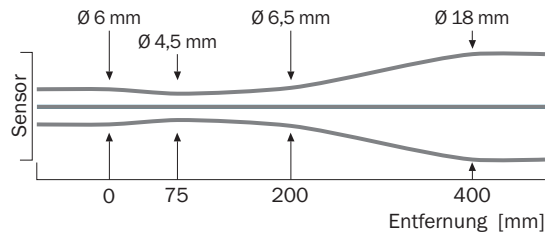

Sensing range diagram

WTB9-3, red light, 350 mm

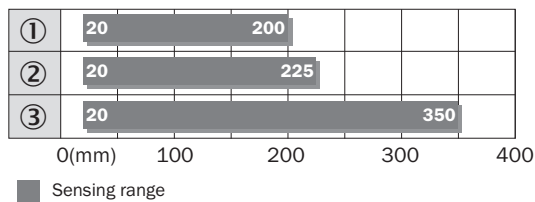

- ① Sensing range on black, 6% remission
- ② Sensing range on gray, 18 % remission
- ③ Sensing range on white, 90% remission

Dimensional drawing (Dimensions in mm (inch))



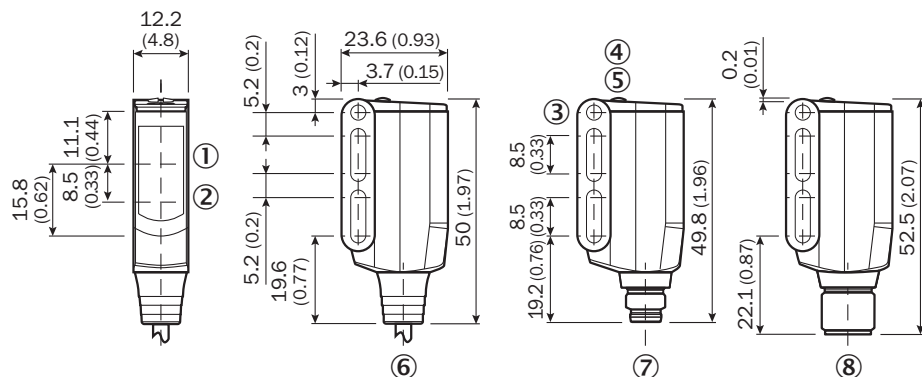

WTB9-3





- ① Center of optical axis, receiver
- ② Center of optical axis, sender
- ③ Mounting hole M3 (Ø 3.1 mm)
- ④ LED indicator yellow: Status of received light beam
- ⑤ LED indicator green: power on
- ⑥ Connection cable 2 m
- ⑦ Connector M8, 4-pin
- ⑧ Male connector M12, 4-pin

Recommended accessories

Other models and accessories → www.sick.com/W9-3

	Brief description	Type	Part no.
Universal bar clamp systems			
	Plate N08 for universal clamp bracket, Zinc plated steel (sheet), Zinc die cast (clamping bracket), Universal clamp (5322626), mounting hardware	BEF-KHS-N08	2051607
Mounting brackets and plates			
	Mounting bracket, steel, zinc coated, mounting hardware included	BEF-WN-W9-2	2022855
	Adapter plate, Stainless steel	BEF-AP-W9	2022734
	Fastening plate with threaded sleeve M3, PMMA, Brass (Br)	BEF-GPM3-W9	4066039
Plug connectors and cables			
	Head A: female connector, M8, 4-pin, straight Head B: cable Cable: PVC, unshielded, 2 m	DOL-0804-G02M	6009870
	Head A: female connector, M8, 4-pin, straight Head B: cable Cable: PVC, unshielded, 5 m	DOL-0804-G05M	6009872

	Brief description	Type	Part no.
	Head A: female connector, M8, 4-pin, angled Head B: cable Cable: PVC, unshielded, 2 m	DOL-0804-W02M	6009871
	Head A: female connector, M8, 4-pin, angled Head B: cable Cable: PVC, unshielded, 5 m	DOL-0804-W05M	6009873
Masks			
	Mask card, vertical/horizontal slots, slot width: 0.5 mm / 1.0 mm / 1.5 mm / 2.0 mm	BL-9-2	4033253

SICK AT A GLANCE

SICK is one of the leading manufacturers of intelligent sensors and sensor solutions for industrial applications. A unique range of products and services creates the perfect basis for controlling processes securely and efficiently, protecting individuals from accidents and preventing damage to the environment.

We have extensive experience in a wide range of industries and understand their processes and requirements. With intelligent sensors, we can deliver exactly what our customers need. In application centers in Europe, Asia and North America, system solutions are tested and optimized in accordance with customer specifications. All this makes us a reliable supplier and development partner.

Comprehensive services complete our offering: SICK LifeTime Services provide support throughout the machine life cycle and ensure safety and productivity.

For us, that is “Sensor Intelligence.”

WORLDWIDE PRESENCE:

Contacts and other locations –www.sick.com

X-ON Electronics

Largest Supplier of Electrical and Electronic Components

Click to view similar products for Sick manufacturer:

Other Similar products are found below :

[6-020-768](#) [CSM-WP11122P](#) [GRL18-P2437](#) [IM05-0B8NS-ZT1](#) [IM12-04BPS-ZC1](#) [KT6W-2P5116](#) [GRSE18-P2442](#) [GRSE18-P2447](#)
[GRTE18-P2412](#) [IM30-15NPS-ZW1](#) [IME08-02BPSZT0S](#) [IME08-2N5PSZT0K](#) [KTM-MB31111P](#) [VTE18-4N2212](#) [WTB11-2P2431](#)
[WLL180T-P434](#) [VTF18-4P1612](#) [VTF-18-4N1240](#) [VTE18-4P8240](#) [VS/VE18-4P3740](#) [WTE280-2P1131](#) [WTE11-2P2432](#) [WTB8-P2231](#)
[CM30-25NNP-EC1](#) [CM18-08BNP-EW1](#) [CM18-12NNP-EC1](#) [CM30-16BPP-EC1](#) [CM30-16BPP-EW1](#) [CM30-25NPP-EW1](#) [E100-](#)
[A2A22C05A](#) [GRL18-P1137](#) [KUP-0606-B](#) [KUP-0610-D](#) [P250H](#) [VT12T-2P410](#) [CQ28-10NPP-KW1](#) [DFS60B-S1PA10000](#) [GL6-P7111](#)
[GRL18-P1132](#) [KT5W-2P1116](#) [WSE11-2N2430](#) [WTB11-2P2461](#) [WSE4-3P2230](#) [WL2SG-2F3235](#) [IMB12-08NPPVC0S](#) [DBS36E-](#)
[BBAK02048](#) [DBS36E-BBEK00500](#) [DBS36E-S3AK01024](#) [DBS36E-S3AK02048](#) [DBS36E-S3EK00600](#)