



# GSE6-P4112

G6

PHOTOELECTRIC SENSORS

**SICK**  
Sensor Intelligence.



### Ordering information

Type	Part no.
GSE6-P4112	1052450

Other models and accessories → [www.sick.com/G6](http://www.sick.com/G6)

Illustration may differ



### Detailed technical data

#### Features

<b>Sensor/detection principle</b>	Through-beam photoelectric sensor
<b>Dimensions (W x H x D)</b>	12 mm x 31.5 mm x 21 mm
<b>Housing design (light emission)</b>	Rectangular
<b>Sensing range max.</b>	0 m ... 15 m
<b>Sensing range</b>	0 m ... 10 m
<b>Type of light</b>	Visible red light
<b>Light source</b>	PinPoint LED <sup>1)</sup>
<b>Light spot size (distance)</b>	Ø 375 mm (12 m)
<b>Wave length</b>	650 nm
<b>Adjustment</b>	None

<sup>1)</sup> Average service life: 100,000 h at T<sub>J</sub> = +25 °C.

#### Mechanics/electronics

<b>Supply voltage</b>	10 V DC ... 30 V DC <sup>1)</sup>
<b>Ripple</b>	± 10 % <sup>2)</sup>
<b>Power consumption</b>	≤ 30 mA <sup>3)</sup>
<b>Output type</b>	PNP

<sup>1)</sup> Limit values when operated in short-circuit protected network: max. 8 A.

<sup>2)</sup> May not exceed or fall below U<sub>V</sub> tolerances.

<sup>3)</sup> Without load.

<sup>4)</sup> At U<sub>V</sub> > 24 V, I<sub>A</sub> max. = 50 mA.

<sup>5)</sup> Signal transit time with resistive load.

<sup>6)</sup> With light/dark ratio 1:1.

<sup>7)</sup> A = V<sub>S</sub> connections reverse-polarity protected.

<sup>8)</sup> B = inputs and output reverse-polarity protected.

<sup>9)</sup> D = outputs overcurrent and short-circuit protected.

<sup>10)</sup> Temperature stability following adjustment +/-10 °C.

<b>Switching mode</b>	Light/dark switching
<b>Switching mode selector</b>	Selectable via light/dark selector
<b>Signal voltage PNP HIGH/LOW</b>	$V_S - (\leq 3 \text{ V}) / \text{ approx. } 0 \text{ V}$
<b>Output current <math>I_{\text{max}}</math></b>	$\leq 100 \text{ mA}^{4)}$
<b>Response time</b>	$< 500 \mu\text{s}^{5)}$
<b>Switching frequency</b>	1,000 Hz <sup>6)</sup>
<b>Connection type</b>	Connector M8, 4-pin
<b>Circuit protection</b>	A <sup>7)</sup> B <sup>8)</sup> D <sup>9)</sup>
<b>Protection class</b>	III
<b>Weight</b>	40 g
<b>Housing material</b>	Plastic, ABS/PC
<b>Optics material</b>	Plastic, PMMA
<b>Enclosure rating</b>	IP67
<b>Items supplied</b>	Stainless steel mounting bracket (1.4301/304) BEF-W100-A
<b>Ambient operating temperature</b>	$-25 \text{ }^\circ\text{C} \dots +55 \text{ }^\circ\text{C}^{10)}$
<b>Ambient storage temperature</b>	$-40 \text{ }^\circ\text{C} \dots +70 \text{ }^\circ\text{C}$
<b>UL File No.</b>	NRKH.E348498 & NRKH7.E348498

1) Limit values when operated in short-circuit protected network: max. 8 A.

2) May not exceed or fall below  $U_V$  tolerances.

3) Without load.

4) At  $U_V > 24 \text{ V}$ ,  $I_A \text{ max.} = 50 \text{ mA}$ .

5) Signal transit time with resistive load.

6) With light/dark ratio 1:1.

7) A =  $V_S$  connections reverse-polarity protected.

8) B = inputs and output reverse-polarity protected.

9) D = outputs overcurrent and short-circuit protected.

10) Temperature stability following adjustment  $\pm 10 \text{ }^\circ\text{C}$ .

## Classifications

<b>ECI@ss 5.0</b>	27270901
<b>ECI@ss 5.1.4</b>	27270901
<b>ECI@ss 6.0</b>	27270901
<b>ECI@ss 6.2</b>	27270901
<b>ECI@ss 7.0</b>	27270901
<b>ECI@ss 8.0</b>	27270901
<b>ECI@ss 8.1</b>	27270901
<b>ECI@ss 9.0</b>	27270901
<b>ETIM 5.0</b>	EC002716
<b>ETIM 6.0</b>	EC002716
<b>UNSPSC 16.0901</b>	39121528

### Adjustments possible

No adjustment possibility

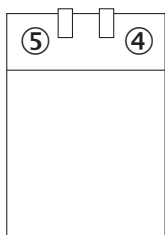

- ④ LED indicator green: Supply voltage active
- ⑤ LED indicator yellow: Status of received light beam

### Connection diagram

Cd-057

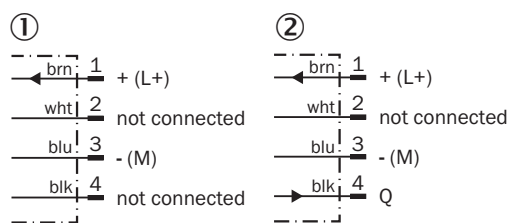

- ① Sender
- ② Receiver

### Characteristic curve

GSE6

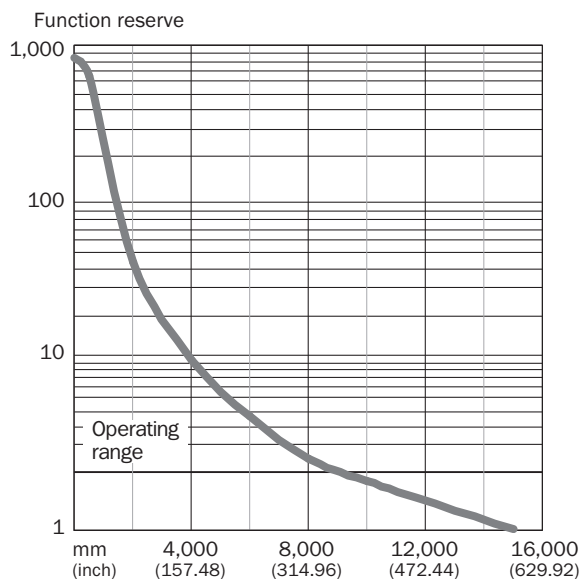

## Light spot size

GSE6

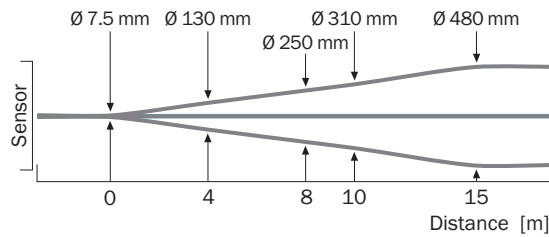

## Sensing range diagram

GSE6

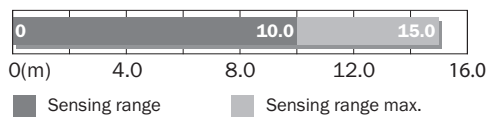

## Dimensional drawing (Dimensions in mm (inch))

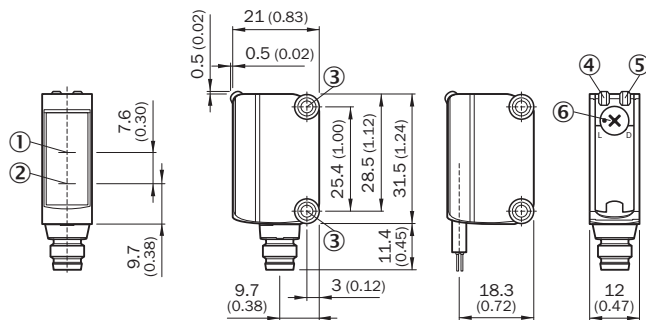

- ① Optical axis, receiver
- ② Optical axis, sender
- ③ Mounting holes M3
- ④ LED indicator green: Supply voltage active
- ⑤ LED indicator yellow: Status of received light beam
- ⑥ Light/ dark rotary switch: L = light switching, D = dark switching

## Recommended accessories

Other models and accessories → [www.sick.com/G6](http://www.sick.com/G6)

	Brief description	Type	Part no.
Universal bar clamp systems			
	Clamp bar to fix G6 sensors on rods of 10 mm, clamp-on design up to 4 mm wall thickness, aluminum (clamp bar), stainless steel (bracket), clamp bar for 10 mm rod mounting and clamp function, mounting bracket, mounting hardware	BEF-KHS-ISG6	2075080

	Brief description	Type	Part no.
Device protection (mechanical)			
	Stainless steel 1.4301 (SVS 304), 3 mm thick protective sleeve for G6, stainless steel 1.4301, mounting hardware included	BEF-SG-G6	2069044
Mounting brackets and plates			
		BEF-WN-G6	2062909
Plug connectors and cables			
	Head A: female connector, M8, 4-pin, straight Head B: cable Cable: PVC, unshielded, 2 m	DOL-0804-G02M	6009870
	Head A: female connector, M8, 4-pin, straight Head B: cable Cable: PVC, unshielded, 5 m	DOL-0804-G05M	6009872
	Head A: female connector, M8, 4-pin, angled Head B: cable Cable: PVC, unshielded, 2 m	DOL-0804-W02M	6009871
	Head A: female connector, M8, 4-pin, angled Head B: cable Cable: PVC, unshielded, 5 m	DOL-0804-W05M	6009873
	Head A: female connector, M8, 4-pin, straight Head B: - Cable: unshielded	DOS-0804-G	6009974
	Head A: female connector, M8, 4-pin, angled Head B: - Cable: unshielded	DOS-0804-W	6009975
	Head A: male connector, M8, 4-pin, straight Head B: - Cable: unshielded	STE-0804-G	6037323
Masks			
	Slit mask, vertical slots, slot width: 1.0 mm, 2 pieces, black, Aluminum, Slit mask (2 pieces)	BEF-SLIT MASK-G6	2075254

## SICK AT A GLANCE

SICK is one of the leading manufacturers of intelligent sensors and sensor solutions for industrial applications. A unique range of products and services creates the perfect basis for controlling processes securely and efficiently, protecting individuals from accidents and preventing damage to the environment.

We have extensive experience in a wide range of industries and understand their processes and requirements. With intelligent sensors, we can deliver exactly what our customers need. In application centers in Europe, Asia and North America, system solutions are tested and optimized in accordance with customer specifications. All this makes us a reliable supplier and development partner.

Comprehensive services complete our offering: SICK LifeTime Services provide support throughout the machine life cycle and ensure safety and productivity.

For us, that is “Sensor Intelligence.”

## WORLDWIDE PRESENCE:

Contacts and other locations –[www.sick.com](http://www.sick.com)

## X-ON Electronics

Largest Supplier of Electrical and Electronic Components

*Click to view similar products for Sick manufacturer:*

Other Similar products are found below :

[6-020-768](#) [CSM-WP11122P](#) [GRL18-P2437](#) [IM05-0B8NS-ZT1](#) [IM12-04BPS-ZC1](#) [KT6W-2P5116](#) [GRSE18-P2442](#) [GRSE18-P2447](#)  
[GRTE18-P2412](#) [IM30-15NPS-ZW1](#) [IME08-02BPSZT0S](#) [IME08-2N5PSZT0K](#) [KTM-MB31111P](#) [VTE18-4N2212](#) [WTB11-2P2431](#)  
[WLL180T-P434](#) [VTF18-4P1612](#) [VTF-18-4N1240](#) [VTE18-4P8240](#) [VS/VE18-4P3740](#) [WTE280-2P1131](#) [WTE11-2P2432](#) [WTB8-P2231](#)  
[CM30-25NNP-EC1](#) [CM18-08BNP-EW1](#) [CM18-12NNP-EC1](#) [CM30-16BPP-EC1](#) [CM30-16BPP-EW1](#) [CM30-25NPP-EW1](#) [E100-](#)  
[A2A22C05A](#) [GRL18-P1137](#) [KUP-0606-B](#) [KUP-0610-D](#) [P250H](#) [VT12T-2P410](#) [CQ28-10NPP-KW1](#) [DFS60B-S1PA10000](#) [GL6-P7111](#)  
[GRL18-P1132](#) [KT5W-2P1116](#) [WSE11-2N2430](#) [WTB11-2P2461](#) [WSE4-3P2230](#) [WL2SG-2F3235](#) [IMB12-08NPPVC0S](#) [DBS36E-](#)  
[BBAK02048](#) [DBS36E-BBEK00500](#) [DBS36E-S3AK01024](#) [DBS36E-S3AK02048](#) [DBS36E-S3EK00600](#)