



WL2S-2P3230

W2S-2

PHOTOELECTRIC SENSORS

SICK
Sensor Intelligence.



Illustration may differ

Ordering information

Type	Part no.
WL2S-2P3230	1063572

Other models and accessories → www.sick.com/W2S-2



Detailed technical data

Features

Sensor/detection principle	Photoelectric retro-reflective sensor, autocollimation
Dimensions (W x H x D)	7.7 mm x 21.8 mm x 13.5 mm
Housing design (light emission)	Rectangular
Sensing range max.	0 m ... 1.2 m ¹⁾
Sensing range	0 m ... 0.55 m ¹⁾
Type of light	Visible red light
Light source	PinPoint LED ²⁾
Light spot size (distance)	Ø 12 mm (250 mm)
Wave length	640 nm
Adjustment	None

¹⁾ Reflector P250F.

²⁾ Average service life: 100,000 h at T_U = +25 °C.

Mechanics/electronics

Supply voltage	10 V DC ... 30 V DC ¹⁾
Ripple	$\leq 5 V_{pp}$ ²⁾
Power consumption	$\leq 20 \text{ mA}$ ³⁾
Output type	PNP
Switching mode	Light/dark switching
Output current $I_{max.}$	$< 50 \text{ mA}$
Response time	$< 0.5 \text{ ms}$ ⁴⁾
Switching frequency	1,000 Hz ⁵⁾
Connection type	Cable with M8 male connector, 4-pin, 200 mm ⁶⁾
Cable material	PVC
Cable diameter	$\varnothing 3 \text{ mm}$
Circuit protection	A ⁷⁾ B ⁸⁾ D ⁹⁾
Polarisation filter	✓
Housing material	Plastic, ABS/PC
Optics material	Plastic, PMMA
Enclosure rating	IP67
Ambient operating temperature	$-25 \text{ °C} \dots +50 \text{ °C}$
Ambient storage temperature	$-40 \text{ °C} \dots +75 \text{ °C}$
UL File No.	NRKH.E181493

¹⁾ Limit values.

²⁾ May not exceed or fall below U_V tolerances.

³⁾ Without load.

⁴⁾ Signal transit time with resistive load.

⁵⁾ With light/dark ratio 1:1.

⁶⁾ Do not bend below 0 °C .

⁷⁾ A = V_S connections reverse-polarity protected.

⁸⁾ B = output reverse-polarity protected.

⁹⁾ D = outputs overcurrent and short-circuit protected.

Classifications

ECl@ss 5.0	27270902
ECl@ss 5.1.4	27270902
ECl@ss 6.0	27270902
ECl@ss 6.2	27270902
ECl@ss 7.0	27270902
ECl@ss 8.0	27270902
ECl@ss 8.1	27270902
ECl@ss 9.0	27270902
ETIM 5.0	EC002717
ETIM 6.0	EC002717
UNSPSC 16.0901	39121528

Connection diagram

Cd-084

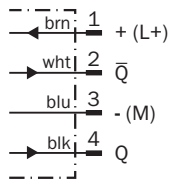

Characteristic curve

WL2S-2

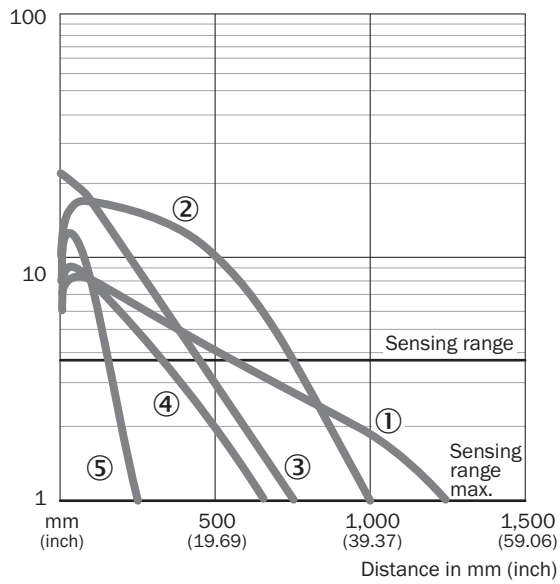

- ① Reflector P250F
- ② Reflector PL20F
- ③ Reflective tape REF-AC1000
- ④ PL10F reflector
- ⑤ Reflector PL8FH

Light spot size

WL2S-2

Spot diameter in mm (inch)

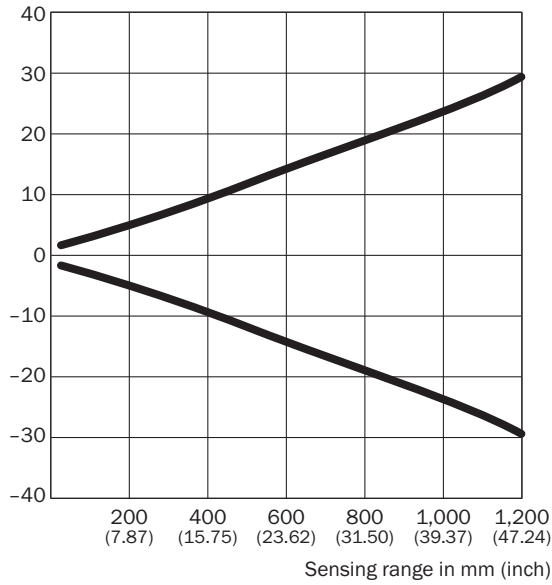

Dimensions in mm (inch)

Sensing range	Spot diameter
20 (0.79)	3.4 (0.13)
100 (3.94)	6.5 (0.26)
250 (9.84)	12.0 (0.47)
500 (19.69)	34.0 (1.34)
1,000 (39.37)	48.0 (1.89)
1,200 (47.24)	60.0 (2.36)

Sensing range diagram

WL2S-2

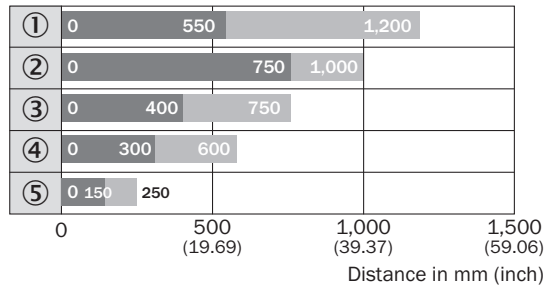

■ Sensing range ■ Sensing range max.

- ① Reflector P250F
- ② Reflector PL20F
- ③ Reflective tape REF-AC1000
- ④ PL10F reflector
- ⑤ Reflector PL8FH

Dimensional drawing (Dimensions in mm (inch))

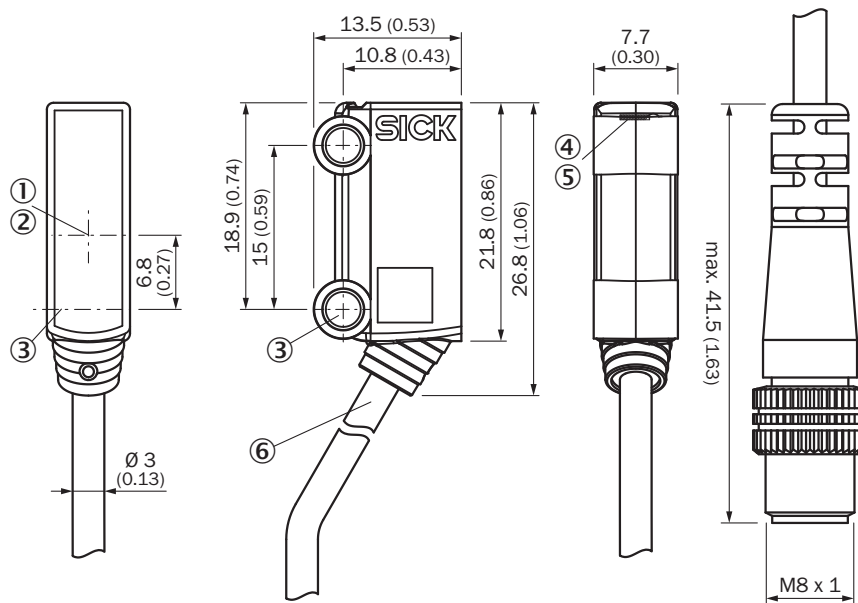

WL2S-2



- ① Optical axis, receiver
- ② Optical axis, sender
- ③ Middle axis fixing hole \varnothing 3.2 mm
- ④ LED indicator green: Supply voltage active
- ⑤ LED indicator yellow: Status of received light beam
- ⑥ Connection

Recommended accessories

Other models and accessories → www.sick.com/W2S-2

	Brief description	Type	Part no.
Mounting brackets and plates			
	Mounting bracket for floor mounting, steel, zinc coated, without mounting hardware	BEF-W2S-A	4034748
	Mounting bracket for wall mounting, steel, zinc coated, without mounting hardware	BEF-W2S-B	4034749
Terminal and alignment brackets			
	Ball clamp bracket, Plastic, mounting hardware included	BEF-GH-MINI01	2023160
Plug connectors and cables			
	Head A: female connector, M8, 4-pin, straight Head B: cable Cable: PVC, unshielded, 2 m	DOL-0804-G02M	6009870
	Head A: female connector, M8, 4-pin, straight Head B: cable Cable: PVC, unshielded, 5 m	DOL-0804-G05M	6009872

	Brief description	Type	Part no.
	Head A: female connector, M8, 4-pin, angled Head B: cable Cable: PVC, unshielded, 2 m	DOL-0804-W02M	6009871
	Head A: female connector, M8, 4-pin, angled Head B: cable Cable: PVC, unshielded, 5 m	DOL-0804-W05M	6009873
Reflectors			
	Rectangular, screw connection, 47 mm x 47 mm, PMMA/ABS, Screw-on, 2 hole mounting	P250	5304812
	Rectangular, screw connection, 38 mm x 15 mm, PMMA/ABS, Screw-on, 2 hole mounting	PL20A	1012719
	Rectangular, screw connection, 56 mm x 28 mm, PMMA/ABS, Screw-on, 2 hole mounting	PL30A	1002314
	Rectangular, screw connection, 37 mm x 56 mm, PMMA/ABS, Screw-on, 2 hole mounting	PL40A	1012720
	Rectangular, screw connection, 80 mm x 80 mm, PMMA/ABS, Screw-on, 2 hole mounting	PL80A	1003865
	Fine triple reflector, screw connection, suitable for laser sensors, 47 mm x 47 mm, PMMA/ABS, Screw-on, 2 hole mounting	P250F	5308843
	Fine triple reflector, screw connection, suitable for laser sensors, 18 mm x 18 mm, PMMA/ABS, Screw-on, 2 hole mounting	PL10F	5311210
	Fine triple reflector, screw connection, suitable for laser sensors, 38 mm x 16 mm, PMMA/ABS, Screw-on, 2 hole mounting	PL20F	5308844
	Fine triple, not self-adhesive, \varnothing 10 mm, \varnothing Reflexionsfläche 8 mm, PMMA/ABS	PL8F	5327934
	Fine triple, not self-adhesive, high temperature up to 99°C, \varnothing 10 mm, \varnothing Reflexionsfläche 8 mm, PMMA/ABS	PL8FH	5328583
	Suitable for laser sensors, self-adhesive, sheet, see alignment note, 225 mm x 225 mm, self-adhesive	REF-AC1000	5319429
	Self-adhesive	REF-IRF-56	5314244

SICK AT A GLANCE

SICK is one of the leading manufacturers of intelligent sensors and sensor solutions for industrial applications. A unique range of products and services creates the perfect basis for controlling processes securely and efficiently, protecting individuals from accidents and preventing damage to the environment.

We have extensive experience in a wide range of industries and understand their processes and requirements. With intelligent sensors, we can deliver exactly what our customers need. In application centers in Europe, Asia and North America, system solutions are tested and optimized in accordance with customer specifications. All this makes us a reliable supplier and development partner.

Comprehensive services complete our offering: SICK LifeTime Services provide support throughout the machine life cycle and ensure safety and productivity.

For us, that is “Sensor Intelligence.”

WORLDWIDE PRESENCE:

Contacts and other locations –www.sick.com

X-ON Electronics

Largest Supplier of Electrical and Electronic Components

Click to view similar products for Sick manufacturer:

Other Similar products are found below :

[6-020-768](#) [CSM-WP11122P](#) [GRL18-P2437](#) [IM05-0B8NS-ZT1](#) [IM12-04BPS-ZC1](#) [KT6W-2P5116](#) [GRSE18-P2442](#) [GRSE18-P2447](#)
[GRTE18-P2412](#) [IM30-15NPS-ZW1](#) [IME08-02BPSZT0S](#) [IME08-2N5PSZT0K](#) [KTM-MB31111P](#) [VTE18-4N2212](#) [WTB11-2P2431](#)
[WLL180T-P434](#) [VTF18-4P1612](#) [VTF-18-4N1240](#) [VTE18-4P8240](#) [VS/VE18-4P3740](#) [WTE280-2P1131](#) [WTE11-2P2432](#) [WTB8-P2231](#)
[CM30-25NNP-EC1](#) [CM18-08BNP-EW1](#) [CM18-12NNP-EC1](#) [CM30-16BPP-EC1](#) [CM30-16BPP-EW1](#) [CM30-25NPP-EW1](#) [E100-](#)
[A2A22C05A](#) [GRL18-P1137](#) [KUP-0606-B](#) [KUP-0610-D](#) [P250H](#) [VT12T-2P410](#) [CQ28-10NPP-KW1](#) [DFS60B-S1PA10000](#) [GL6-P7111](#)
[GRL18-P1132](#) [KT5W-2P1116](#) [WSE11-2N2430](#) [WTB11-2P2461](#) [WSE4-3P2230](#) [WL2SG-2F3235](#) [IMB12-08NPPVC0S](#) [DBS36E-](#)
[BBAK02048](#) [DBS36E-BBEK00500](#) [DBS36E-S3AK01024](#) [DBS36E-S3AK02048](#) [DBS36E-S3EK00600](#)