



IQ40-20BPPKK0S

IQG

INDUCTIVE PROXIMITY SENSORS

SICK
Sensor Intelligence.



Ordering information

Type	Part no.
IQ40-20BPPK0S	1071860

Other models and accessories → www.sick.com/IQG



Detailed technical data

Features

Housing	Rectangular
Housing	Standard design
Dimensions (W x H x D)	40 mm x 40 mm x 118 mm
Sensing range S_n	20 mm
Safe sensing range S_a	16.2 mm
Installation type	Flush
Switching frequency	150 Hz
Connection type	Cable gland
Output type	PNP
Output function	Complementary
Electrical wiring	DC 4-wire
Enclosure rating	IP67, IP68, IP69K

Mechanics/electronics

Supply voltage	10 V DC ... 30 V DC
Ripple	$\leq 10 V_{pp}^{1)}$
Voltage drop	$\leq 2 V$
Current consumption	$\leq 20 mA^{2)}$
Time delay before availability	$\leq 50 ms$
Hysteresis	$3 \% \dots 15 \%^{3)}$
Reproducibility	$\leq 2 \%$
Temperature drift (of S_r)	$\pm 10 \%$
Continuous current I_a	$\leq 200 mA$
Short-circuit protection	✓

¹⁾ Of U_b .

²⁾ Without load.

³⁾ Of S_r .

⁴⁾ Reference voltage: 50 V DC.

Reverse polarity protection	✓
Power-up pulse protection	✓
Shock and vibration resistance	30 g, 11 ms / 10 ... 55 Hz, 1 mm
Ambient operating temperature	-25 °C ... +85 °C
Ambient storage temperature	-40 °C ... +85 °C
Housing material	Plastic, PA 66
Sensing face material	Plastic, PA 66
Tightening torque, max.	1.8 Nm
Protection class	II ⁴⁾
UL File No.	E348498

¹⁾ Of Ub.

²⁾ Without load.

³⁾ Of S_r.

⁴⁾ Reference voltage: 50 V DC.

Reduction factors

Note	The values are reference values which may vary
Stainless steel (V2A, 304)	Approx. 0.71
Aluminum (Al)	Approx. 0.3
Copper (Cu)	Approx. 0.25
Brass (Br)	Approx. 0.36

Installation note

Remark	Associated graphic see "Installation"
A	0 mm
B	40 mm
C	40 mm
D	60 mm
E	0 mm
F	70 mm

Classifications

ECl@ss 5.0	27270101
ECl@ss 5.1.4	27270101
ECl@ss 6.0	27270101
ECl@ss 6.2	27270101
ECl@ss 7.0	27270101
ECl@ss 8.0	27270101
ECl@ss 8.1	27270101
ECl@ss 9.0	27270101
ETIM 5.0	EC002714
ETIM 6.0	EC002714
UNSPSC 16.0901	39122230

Installation note

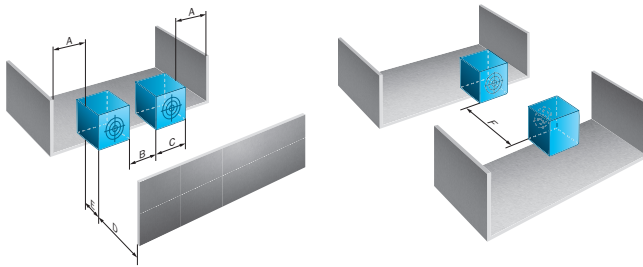

Connection diagram

Cd-030

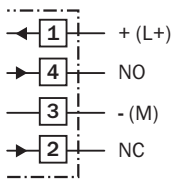

Characteristic curve

IQ40-20Bxxxx

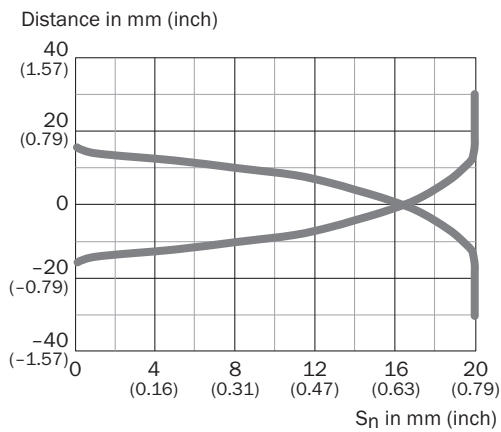

Dimensional drawing (Dimensions in mm (inch))

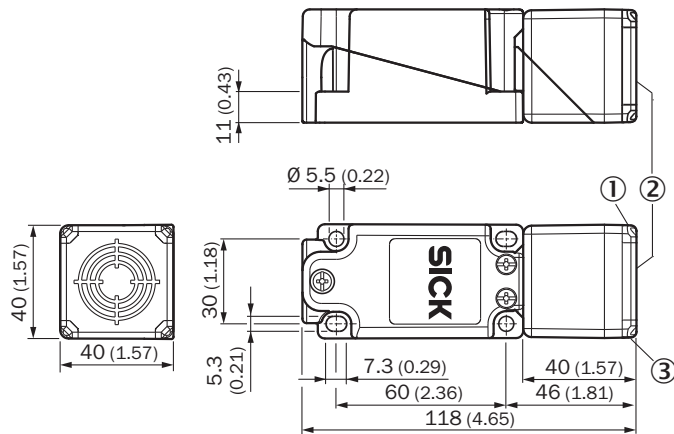

IQG Standard, cable gland



- ① LED output state, yellow
- ② Sensing face
- ③ Operational status LED, green

Recommended accessories

Other models and accessories → www.sick.com/IQG

	Brief description	Type	Part no.
Plug connectors and cables			
	Head A: female connector, M12, 4-pin, straight Head B: cable Cable: PVC, unshielded, 2 m	DOL-1204-G02M	6009382
	Head A: female connector, M12, 4-pin, straight Head B: cable Cable: PVC, unshielded, 5 m	DOL-1204-G05M	6009866
	Head A: female connector, M12, 4-pin, straight Head B: cable Cable: PVC, unshielded, 10 m	DOL-1204-G10M	6010543
	Head A: female connector, M12, 4-pin, angled with LED Head B: cable Cable: PVC, unshielded, 2 m	DOL-1204-L02M	6027945
	Head A: female connector, M12, 4-pin, angled with LED Head B: cable Cable: PVC, unshielded, 5 m	DOL-1204-L05M	6027944
	Head A: female connector, M12, 4-pin, angled with LED Head B: cable Cable: PVC, unshielded, 10 m	DOL-1204-L10M	6027946
	Head A: female connector, M12, 4-pin, angled Head B: cable Cable: PVC, unshielded, 2 m	DOL-1204-W02M	6009383
	Head A: female connector, M12, 4-pin, angled Head B: cable Cable: PVC, unshielded, 5 m	DOL-1204-W05M	6009867

	Brief description	Type	Part no.
	Head A: female connector, M12, 4-pin, angled Head B: cable Cable: PVC, unshielded, 10 m	DOL-1204-W10M	6010541
	Head A: female connector, M12, 4-pin, straight Head B: - Cable: unshielded	DOS-1204-G	6007302
	Head A: female connector, M12, 4-pin, angled Head B: - Cable: unshielded	DOS-1204-W	6007303

SICK AT A GLANCE

SICK is one of the leading manufacturers of intelligent sensors and sensor solutions for industrial applications. A unique range of products and services creates the perfect basis for controlling processes securely and efficiently, protecting individuals from accidents and preventing damage to the environment.

We have extensive experience in a wide range of industries and understand their processes and requirements. With intelligent sensors, we can deliver exactly what our customers need. In application centers in Europe, Asia and North America, system solutions are tested and optimized in accordance with customer specifications. All this makes us a reliable supplier and development partner.

Comprehensive services complete our offering: SICK LifeTime Services provide support throughout the machine life cycle and ensure safety and productivity.

For us, that is “Sensor Intelligence.”

WORLDWIDE PRESENCE:

Contacts and other locations –www.sick.com

X-ON Electronics

Largest Supplier of Electrical and Electronic Components

Click to view similar products for Sick manufacturer:

Other Similar products are found below :

[6-020-768](#) [CSM-WP11122P](#) [GRL18-P2437](#) [IM05-0B8NS-ZT1](#) [IM12-04BPS-ZC1](#) [KT6W-2P5116](#) [GRSE18-P2442](#) [GRSE18-P2447](#)
[GRTE18-P2412](#) [IM30-15NPS-ZW1](#) [IME08-02BPSZT0S](#) [IME08-2N5PSZT0K](#) [KTM-MB31111P](#) [VTE18-4N2212](#) [WTB11-2P2431](#)
[WLL180T-P434](#) [VTF18-4P1612](#) [VTF-18-4N1240](#) [VTE18-4P8240](#) [VS/VE18-4P3740](#) [WTE280-2P1131](#) [WTE11-2P2432](#) [WTB8-P2231](#)
[CM30-25NNP-EC1](#) [CM18-08BNP-EW1](#) [CM18-12NNP-EC1](#) [CM30-16BPP-EC1](#) [CM30-16BPP-EW1](#) [CM30-25NPP-EW1](#) [E100-](#)
[A2A22C05A](#) [GRL18-P1137](#) [KUP-0606-B](#) [KUP-0610-D](#) [P250H](#) [VT12T-2P410](#) [CQ28-10NPP-KW1](#) [DFS60B-S1PA10000](#) [GL6-P7111](#)
[GRL18-P1132](#) [KT5W-2P1116](#) [WSE11-2N2430](#) [WTB11-2P2461](#) [WSE4-3P2230](#) [WL2SG-2F3235](#) [IMB12-08NPPVC0S](#) [DBS36E-](#)
[BBAK02048](#) [DBS36E-BBEK00500](#) [DBS36E-S3AK01024](#) [DBS36E-S3AK02048](#) [DBS36E-S3EK00600](#)