

Cooper Crouse-Hinds® Commercial Products

Weatherproof Products

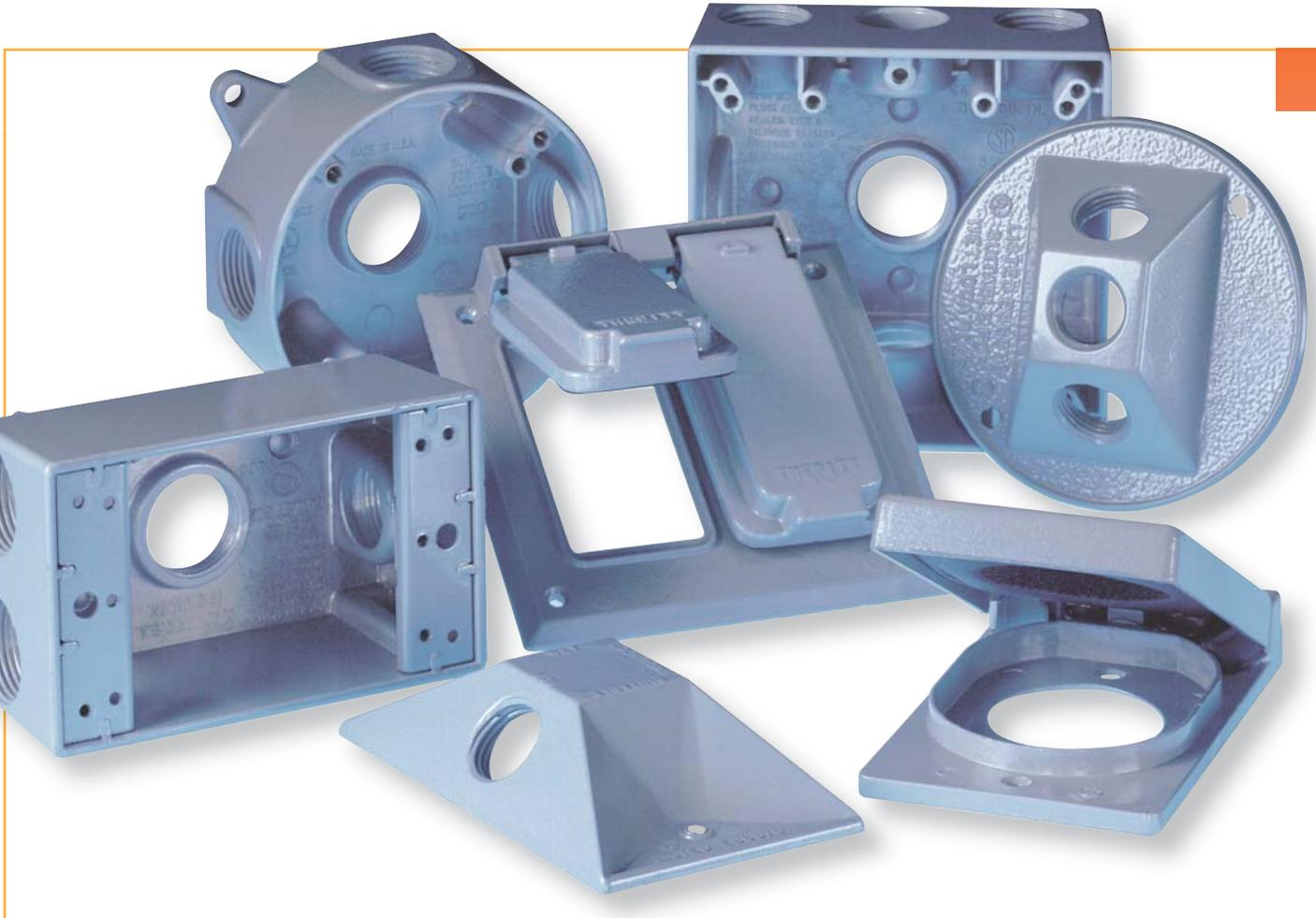

Complete line of Weatherproof Products includes:

- *Outlet Boxes & Covers*
- *Conduit Outlet Bodies, Covers & Gaskets*
- *Vaporproof Lighting*
- *Cast Enclosures & Accessories*
- *Floodlights*
- *Wall Packs*
- *Service Entrance Elbows & Caps*
- *Garden Lights*

COOPER Crouse-Hinds

CROUSE-HINDS
COMMERCIAL
PRODUCTS

Weatherproof Products

Commercial Products complete line of Weatherproof Products includes:



- Outlet Boxes and Covers
- Vaporproof Lighting & Lampholders
- Cast Enclosures & Accessories
- Floodlights
- Wall Packs
- Conduit Outlet Bodies
- Service Entrance Elbows & Caps
- Garden Lights



Commercial Products Weatherproof Products include:

BOXES AND ACCESSORIES

- Rugged continuous and seamless die cast construction prevents entry of dirt, dust and moisture
- Powder coating is applied for uniform cosmetic coating and weatherproof durability
- Closure plugs, ground screw and mounting lugs included
- Mounting can be achieved with mounting lugs or by using integral mounting knockouts
- Clear UL marking cast into each box and extension ring facilitate electrical inspection
- Continuous box and cover compression ensure complete sealing at gasket interface to prevent moisture entry
- 1 gang
- 2 & 3 gang
- 1 & 2 gang extensions
- Round



See page 4-6



WEATHERPROOF COVERS:

BLANK, RAISED, SELF CLOSING, TOGGLE SWITCH & ROUND

Applications:

- For use with 1-gang, 2-gang and Round Outlet Boxes
- Blank covers are for use whenever weatherproof protection is required
- Raised covers provide a means of mounting detection devices, light sensitive photocells and accessories
- In-use covers provide protection when plug is installed and receptacle is in use
- Covers with self-closing lids provide weatherproof protection when receptacle is not in use
- Toggle switch covers provide weatherproof protection when an "on-off" type switch is required
- For GFCI receptacles, single and duplex receptacles, switches, combination devices
- Self-closing covers with gasket and screws included
- Mounting hardware and gasket provided with each cover
- 1 & 2 gang
- 1 & 2 gang GFI
- 1 & 2 gang Toggle Switch
- Aluminum Blank
- Round
- Rectangular



See page 7-9



Commercial Products Weatherproof Products include:

VAPORPROOF LIGHTING FIXTURES

- Used in applications such as: subways, construction sites, bridges, tunnels, coolers, wastewater and sewage treatment plants, schools, building entrances
 - All fixtures are industrial grade, available factory assembled, or in components, fully gasketed
 - Engineered to protect the interior from deteriorating effects of ice, corrosive fumes, non-explosive vapors, etc.
 - Surface mounted
 - Pendant mounted
 - Box mounted
 - Incandescent
 - Fluorescent
- See pages 10-11



LAMP HOLDERS

- For exterior or interior lighting
 - For safety and security, light up walkways, driveways and doorways
 - Locking swivel knuckle allows positive lamp positioning and pinpoint directional aiming
 - Lampholders supplied with porcelain sockets, internal gaskets, extra long wire leads, hardware and installation instructions
- See page 12

HID LIGHTING LUMINAREA™ SERIES: AREA, FLOODLIGHT AND WALLPACK

Typical applications for the Luminarea series lighting include, but are not limited to, the following: parking garages, parking lots, storage areas, stairwells, corridors, lobbies, area lighting, street lighting, recreational and security lighting, banks, buildings, stores and restaurants.

- Durable die cast aluminum housing for long product life
- Architectural bronze powder paint finish for corrosive environments
- Stainless steel hardware

Area Luminaries feature:

- Vandal-resistant polycarbonate lens
- Side and top plugged threaded entries for easy field wiring

Floodlight Luminaries feature:

- Hinged lens for easy access to wiring and lamp chamber
- Polished aluminum reflector maximizes light output
- Side, bottom and rear plugged threaded entries for easy wiring

Wallpack Luminaries feature:

- Hinged lens for easy access to wiring and lamp chamber
 - Glass prismatic lens provides superior light distribution
- See pages 13-17



PHOTOELECTRIC LIGHTING

- For automatic timed control operation
- See page 19

GARDEN LIGHTS

- For accent lighting along walkways, driveways, terraces, porches, pools, patios and garden areas
 - Die cast construction prevents moisture entry
 - Powder coat finish provides for maximum durability and corrosion resistance
 - Porcelain socket with high temperature leads allowing for easy field maintenance
 - 3 tier and 4 tier
 - Incandescent and Fluorescent
- See page 18

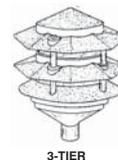

SERVICE ENTRANCE ELBOWS AND CAPS

- Service entrance caps used indoors or outdoors, use in an overhead service entrance
 - Rugged seamless, die cast construction that prevents moisture entry
 - Powder coat finish for maximum weatherproof durability and corrosion resistance
 - Flat back design for easy mounting close to walls
 - Spacious, accessible wiring chamber provides a convenient location to pull conductors and make splices
- See page 24



SERIES 5 COMBINATION CONDUIT OUTLET BODIES FOR EMT AND IMC OR RIGID

Die cast aluminium Series 5 Conduit Bodies are used in conduit systems to:

- Act as pull outlets for conductors being installed
 - Provide openings for making splices and taps in conductors
 - Act as mounting outlets for lighting fixtures and wiring devices
 - Connect conduit sections
 - Provide taps for branch conduit runs
 - Make 90-degree bends in conduit runs
 - Provide for access to conductors for maintenance and future system changes
 - Available with threaded hubs for use with IMC or Rigid conduit, combination body supplied threaded and with set screw for use with IMC, Rigid or EMT conduit
 - Snap-Pack™, body, cover and gasket pre-packaged flexibility in one convenient box.
- See pages 25-27



W-SERIES CAST-IRON WEATHERPROOF JUNCTION BOXES & ACCESSORIES

- Extensive line of over 196 boxes in five different styles
 - XJG internally grounded and XD weathertight expansion and deflection fittings available
- See pages 28-40



Technical Data – Weatherproof Outlet Boxes

Cooper Crouse-Hinds weatherproof products are manufactured in compliance with U.L. requirements for weatherproof boxes and covers and meet U.L. Standard #514A. Cooper Crouse-Hinds lighting products comply with the U.L. requirements of standard UL 1598 and are suitable for wet locations.

Cooper Crouse-Hinds weatherproof products are rust and corrosion resistant made of rugged die-cast construction. Cooper Crouse-Hinds weatherproof products are provided with necessary gaskets, plugs and screws, making installation trouble free.

All products are powder coat painted and various colors are available.

Cooper Crouse-Hinds weatherproof boxes and covers are individually shrink-wrapped. Cooper Crouse-Hinds weatherproof cast aluminum boxes are lugged except where noted and are provided with plugs. The self-closing weatherproof covers are zinc die-cast. The weatherproof lampholders have porcelain sockets and are rated up to 150 watts and have 8½" wire leads.

Vaporite fixtures are die-cast aluminum and the screw-on guards are die-cast zinc, with Allen-Head set screws for locking in place. The fixtures also have a neoprene gasket and porcelain clip-in socket.

SINGLE GANG WEATHERPROOF OUTLET BOXES – 18.0 CUBIC INCH CAPACITY – 2" DEEP CAST ALUMINUM – UL LISTED FOR WET LOCATIONS

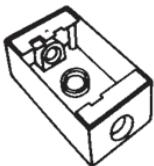

TP7010 – TP7018

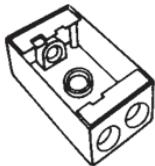

TP7026, TP7034

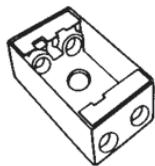

TP7042, TP7050

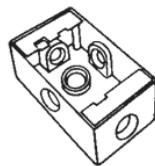

TP7058, TP7066

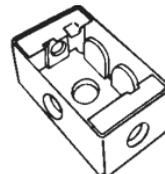

TP7071

Product Number	Description	Outlet Holes	Color	Std. Unit Carton	Wt. Lbs Per 100
TP7010	With Lugs	3-½"	Gray	50	58.3
TP7011	With Lugs	3-½"	White	50	58.3
TP7012	With Lugs	3-½"	Bronze	50	58.3
TP7018	With Lugs	3-¾"	Gray	50	58.3
TP7026	With Lugs	4-½"	Gray	50	58.3
TP7034	With Lugs	4-¾"	Gray	50	58.3
TP7042	With Lugs	5-½"	Gray	50	58.3
TP7050	With Lugs	5-¾"	Gray	50	58.3
TP7058	Side Entry, With Lugs	5-½"	Gray	50	58.3
TP7066	Side Entry, With Lugs	5-¾"	Gray	50	58.3
TP7071	Horiz. Mounting, With Lugs	4-½"	Gray	50	58.3

SINGLE GANG DEEP WEATHERPROOF BOXES – 24.0 CUBIC INCH CAPACITY – 2 5/8" DEEP CAST ALUMINUM-UL LISTED FOR WET LOCATIONS

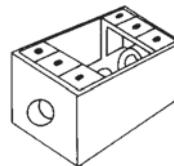

TP7074, TP7078, TP7082

Product Number	Description	Outlet Holes	Color	Std. Unit Carton	Wt. Lbs Per 100
TP7074	With Lugs	3-½"	Gray	25	80
TP7078	With Lugs	3-¾"	Gray	25	80
TP7082	With Lugs	3-1"	Gray	25	80

Weatherproof Outlet Boxes

TWO GANG WEATHERPROOF OUTLET BOXES – 30.5 CUBIC INCH CAPACITY

2" DEEP, ALL TWO GANG BOXES HAVE 2 MOUNTING LUGS AS STANDARD
CAST ALUMINUM-UL LISTED FOR WET LOCATIONS

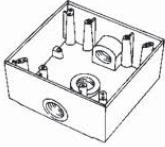

TP7086-TP7090

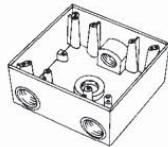

TP7094, TP7098

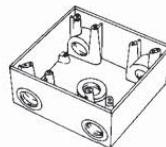

TP7102, TP7106

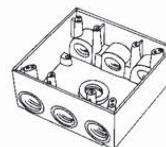

TP7110, TP7114

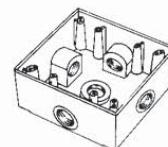

TP7118, TP7122

Product Number	Description	Std. Unit Carton	Color	Wt. Lbs Per 100
TP7086	3-1/2" Holes	10	Gray	83.3
TP7087	3-1/2" Holes	10	White	83.3
TP7088	3-1/2" Holes	10	Bronze	83.3
TP7090	3-3/4" Holes	10	Gray	83.3
TP7094	4-1/2" Holes	10	Gray	83.3
TP7098	4-3/4" Holes	10	Gray	83.3
TP7102	5-1/2" Holes	10	Gray	83.3
TP7106	5-3/4" Holes	10	Gray	83.3
TP7110	7-1/2" Holes	10	Gray	83.3
TP7114	7-3/4" Holes	10	Gray	83.3
TP7118	5-1/2" Holes	10	Gray	83.3
TP7122	5-3/4" Holes	10	Gray	83.3

TWO AND THREE GANG DEEP WEATHERPROOF OUTLET BOXES –

2 5/8" DEEP, ALL BOXES ARE STANDARD WITH MOUNTING LUGS
CAST ALUMINUM-UL LISTED FOR WET LOCATIONS

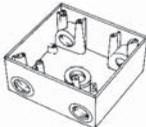

TP7126, TP7130, TP7134

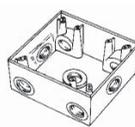

TP7137, TP7138, TP7142

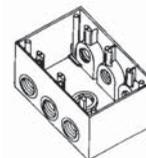

TP7143, TP7144

Product Number	Description	Color	Std. Unit Carton	Capacity Cu. In.	Wt. Lbs Per 100
TWO GANG DEEP WEATHERPROOF OUTLET BOXES					
TP7126	5-1/2" Holes	Gray	6	37	140
TP7130	5-3/4" Holes	Gray	6	37	140
TP7134	5-1" Holes	Gray	6	37	140
TP7137	7-1/2" Holes	Gray	6	37	140
TP7138	7-3/4" Holes	Gray	6	37	140
TP7142	7-1" Holes	Gray	6	37	140
THREE GANG DEEP WEATHERPROOF OUTLET BOXES					
TP7143	7-3/4" Holes	Gray	5	59	159
TP7144	7-1" Holes	Gray	5	59	159

Weatherproof Outlet Boxes

ONE & TWO GANG WEATHERPROOF EXTENSIONS
1" DEEP, DIE-CAST ALUMINUM EXTENSION RING
GASKET AND MOUNTING SCREWS INCLUDED WITH COVER
UL LISTED FOR WET LOCATIONS

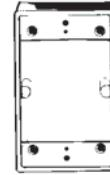

TP7120

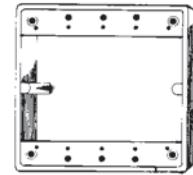

TP7123

Product Number	Description	Color	Std. Unit Carton	Capacity Cu. In.	Wt. Lbs Per 100
TP7120	Single Gang	Gray	25	9	27.2
TP7123	Two Gang	Gray	10	10	27.2

EXTENSION ADAPTER

DIE-CAST ALUMINUM, UL LISTED FOR WET LOCATIONS
3 CLOSURE PLUGS, MOUNTING SCREW AND GASKET INCLUDED
WITH COVER

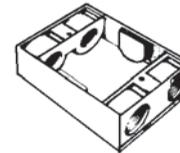

Product Number	Description	Color	Std. Unit Carton	Capacity Cu. In.	Wt. Lbs Per 100
TP7173	4-1/2" Holes	Gray	25	13.0	23.6
TP7174	4-3/4" Holes	Gray	25	13.0	27.8

4" ROUND WEATHERPROOF OUTLET BOXES – 15.5 CUBIC INCH CAPACITY

1 1/2" DEEP, DIE-CAST ALUMINUM, UL LISTED FOR WET LOCATIONS
4 CLOSURE PLUGS AND GROUND SCREW INCLUDED WITH BOX
GASKET AND 2 MOUNTING SCREWS INCLUDED WITH COVER

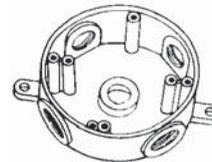

Product Number	Side Holes	Back Hole	Std. Unit Carton	Color	Wt. Lbs Per 100
TP7146	4-1/2"	1/2"	25	Gray	79.2
TP7148	4-1/2"	1/2"	25	White	79.2
TP7149	4-1/2"	1/2"	25	Bronze	79.2
TP7150	4-3/4"	3/4"	25	Gray	79.2
TP7158	Blank Cover Plate		50	Gray	20.8

WITH BLANK PLATE

TP7147	4-1/2"	1/2"	24	Gray	100
TP7151	4-3/4"	3/4"	24	Gray	100

2" DEEP ROUND WEATHERPROOF OUTLET BOX EXTENSION (18.3 CUBIC INCH CAPACITY)

TP7152	4-1/2"	—	25	Gray	58.3
--------	--------	---	----	------	------

Weatherproof Outlet Covers

WEATHERPROOF COVERS

ONE & TWO GANG, SELF-CLOSING COVERS WITH GASKETS
UL LISTED, ZINC, DIE-CAST

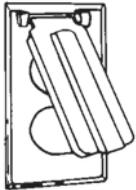

TP7199



TP7202

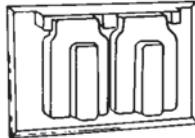

TP7206 – TP7209

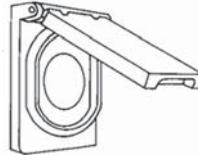

TP7214

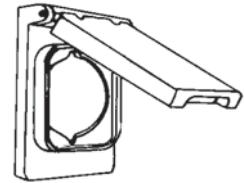

TP7218

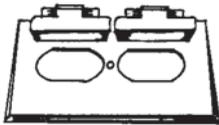

TP7220

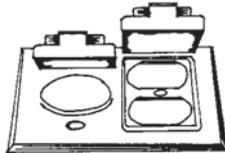

TP7224

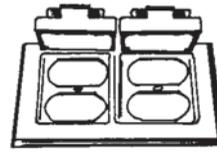

TP7228

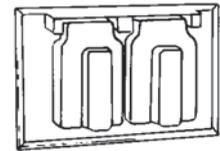

TP7232

Product Number	Description	Color	Std. Unit Carton	Wt. Lbs Per 100
TP7199	One Gang Vertical Duplex Cover	Gray	50	61.1
TP7202	One Gang – For Single Receptacle or Switch – 1.52" Dia. Opening	Gray	25	42.0
TP7206	One Gang – For Duplex Receptacle or Combination Switch	Natural	50	38.0
TP7207	One Gang – For Duplex Receptacle or Combination Switch	Gray	50	38.0
TP7208	One Gang – For Duplex Receptacle or Combination Switch	White	50	38.0
TP7209	One Gang – For Duplex Receptacle or Combination Switch	Bronze	50	38.0
TP7214	One Gang Vertical – For Single Receptacle or Switch 1.62" Dia. Opening	Gray	25	61.1
TP7218	One Gang – For 20, 30 and 50 A Receptacles (2.125" Dia.)	Gray	25	55.6
TP7220	Two Gang – For Two Single Receptacles and/or Switches	Gray	10	66.7
TP7224	Two Gang – For One Single Receptacle or Switch and One Duplex Receptacle, Switch or Combination Device	Gray	10	62.0
TP7228	Two Gang – For Two Duplex Receptacles, Switches or Combination Device	Gray	10	61.1
TP7232	One Gang Stay Open – For Duplex Receptacles, Switches or Combination Devices, Non UL Listed	Natural	50	38.0
TP7233	One Gang Stay Open – For Duplex Receptacles, Switches or Combination Devices, Non UL Listed	Gray	50	38.0

CLOSURE PLUGS – ZINC DIE-CAST†

Product Number	Description	Color	Std. Unit Carton	Wt. Lbs Per 100
TP7940	1/2"	Gray	100	1.5
TP7942	1/2"	Bronze	100	1.5
TP7944	3/4"	Gray	50	2.1

† CSA certified

Weatherproof Outlet Covers

WEATHERPROOF COVERS ONE & TWO GANG SELF-CLOSING GFI COVERS WITH GASKETS, UL LISTED, ZINC DIE-CAST

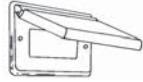

TP7236 – TP7238



TP7240 – TP7242



TP7244



TP7248



TP7252

Product Number	Description	Color	Std. Unit Carton	Wt. Lbs Per 100
TP7236	One Gang – For Horizontal GFI Devices	Gray	25	42
TP7237	One Gang – For Horizontal GFI Devices	White	25	42
TP7238	One Gang – For Horizontal GFI Devices	Bronze	25	42
TP7240	One Gang – For Vertical GFI Devices	Gray	25	54
TP7241	One Gang – For Vertical GFI Devices	White	25	54
TP7242	One Gang – For Vertical GFI Devices	Bronze	25	54
TP7244	Two Gang – For Vertical GFI Devices and One Single Switch or Receptacle	Gray	10	61.1
TP7248	Two Gang – For One Vertical GFI Device and One Duplex Receptacle, Switch or Combination Device	Gray	10	61.1
TP7252	Two Gang – For Two GFI Devices	Gray	10	55.6

WEATHERPROOF COVERS FOR ONE & TWO GANG BOXES “CONSTANT USE” DUPLEX/GFI COVER UL & CSA LISTED, POLYCARBONATE



TP7490
3 1/8" Deep



TP7495
2 1/4" Deep

Product Number	Description	Color	Std. Unit Carton	Wt. Lbs Per 100
TP7490	One Gang, Vertical Mtg. For Duplex or GFI Device (Inserts Included)	Clear	6	41.7
TP7495	One or Two Gang, Vertical or Horizontal Mtg. For One Duplex or GFI Device (Inserts Included)	Clear	6	75

WEATHERPROOF COVERS ONE & TWO GANG TOGGLE SWITCH COVERS WITH GASKETS STAMPED ALUMINUM UL LISTED

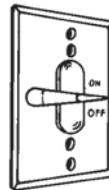

TP7256

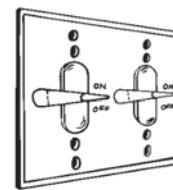

TP7268

Product Number	Description	Std. Unit Carton	Wt. Lbs Per 100
TP7256	One Gang	50	12
TP7260	One Gang With 15A-125V Single Pole Switch	50	27.8
TP7268	Two Gang	10	16.7
TP7272	Two Gang With 2-15A 125V Single Pole Switch	10	33.3
TP7276	Two Gang With 2-15A 125V 3-Way Switch	10	33.3

Weatherproof Outlet Covers

ALUMINUM BLANK BOX WEATHERPROOF COVERS WITH GASKETS UL LISTED FOR WET LOCATIONS



TP7292 – TP7294



TP7296 – TP7298

Product Number	Description	Color	Std. Unit Carton	Wt. Lbs Per 100
TP7292	One Gang	Gray	100	8.3
TP7293	One Gang	White	100	8.3
TP7294	One Gang	Bronze	100	8.3
TP7296	Two Gang	Gray	50	12.5
TP7297	Two Gang	White	50	12.5
TP7298	Two Gang	Bronze	50	12.5

ROUND AND RECTANGULAR WEATHERPROOF COVERS WITH GASKETS, ZINC DIE-CAST, UL LISTED FOR WET LOCATIONS

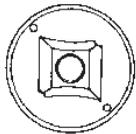

TP7300 – 7302

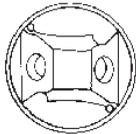

TP7304 – 7306

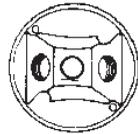

TP7308 – 7310

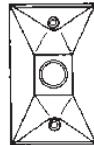

TP7312 – 7314

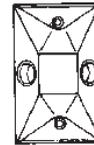

TP7316 – 7318

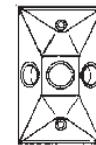

TP7320 – 7322

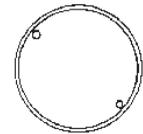

TP7158 – 7160

Product Number	Description	No. of Outlet Holes	Color	Std. Unit Carton	Wt. Lbs Per 100
TP7300	4½" Round	1-½"	Gray	25	20.8
TP7301	4½" Round	1-½"	White	25	20.8
TP7302	4½" Round	1-½"	Bronze	25	20.8
TP7304	4½" Round	2-½"	Gray	25	33.3
TP7305	4½" Round	2-½"	White	25	33.3
TP7306	4½" Round	2-½"	Bronze	25	33.3
TP7308	4½" Round	3-½"	Gray	25	33.3
TP7309	4½" Round	3-½"	White	25	33.3
TP7310	4½" Round	3-½"	Bronze	25	33.3
TP7312	Rectangular	1-½"	Gray	25	33.3
TP7313	Rectangular	1-½"	White	25	33.3
TP7314	Rectangular	1-½"	Bronze	25	33.3
TP7316	Rectangular	2-½"	Gray	25	33.3
TP7317	Rectangular	2-½"	White	25	33.3
TP7318	Rectangular	2-½"	Bronze	25	33.3
TP7320	Rectangular	3-½"	Gray	25	33.3
TP7321	Rectangular	3-½"	White	25	33.3
TP7322	Rectangular	3-½"	Bronze	25	33.3
TP7158	Blank Round	—	Gray	50	20.8
TP7159	Blank Round	—	White	50	20.8
TP7160	Blank Round	—	Bronze	50	20.8

Vapor Proof Lighting Incandescent

VAPOR PROOF FIXTURES – GASKETED CORROSION RESISTANT DIE-CAST CONSTRUCTION, GLASS GLOBES, DIE-CAST GUARDS, UL LISTED



TP7600, TP7601,
TP7800, TP7801,
TP7860



TP7610, TP7611,
TP7805



TP7620, TP7810
TP7621, TP7811



TP7630, TP7815



TP7640, TP7820

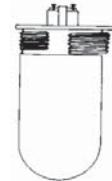

TP7650, TP7825

Product Number	Description	Hole Size	Watts	Std. Unit Carton	Wt. Lbs Per 100
4" BOX MOUNTED					
TP7600	Clear Globe, Cast Guard	1/2"	100	1	325
TP7601	Clear Globe, Cast Guard	3/4"	100	1	324
TP7800	Clear Globe, Wire Guard	1/2"	200	1	516.7
TP7801	Clear Globe, Wire Guard	3/4"	200	1	516
TP7860	Fluorescent Clear Globe, Wire Guard	1/2"	13	1	413
TP7610	Clear Globe	1/2"	100	1	258.3
TP7611	Clear Globe	3/4"	100	1	258
TP7805	Clear Globe	1/2"	200	1	283.3
PENDANT MOUNT					
TP7620	Clear Globe, Cast Guard	1/2"	100	1	300
TP7621	Clear Globe, Cast Guard	3/4"	100	1	299
TP7810	Clear Globe, Wire Guard	1/2"	200	1	350
TP7811	Clear Globe, Wire Guard	3/4"	200	1	349
TP7630	Clear Globe	1/2"	100	1	208.4
TP7815	Clear Globe	1/2"	200	1	258.4
SURFACE MOUNT, FITS 3" and 4" ROUND BOXES					
TP7640	Clear Globe, Cast Guard		100	1	275
TP7820	Clear Globe, Wire Guard		200	1	333.3
TP7650	Clear Globe		100	1	216.7
TP7825	Clear Globe		200	1	180



TP7660, TP7830



TP7670, TP7835



TP7680, TP7840, TP7870



TP7690, TP7845

Product Number	Description	Watts	Std. Unit Carton	Wt. Lbs Per 100
RIGHT ANGLE BRACKET FIXTURES				
TP7660	Clear Globe, Cast Guard	100	1	300
TP7830	Clear Globe, Wire Guard	200	1	516.7
TP7670	Clear Globe	100	1	200
TP7835	Clear Globe	200	1	400
BOX MOUNTED				
TP7680	Clear Globe, Cast Guard	100	1	350
TP7840	Clear Globe, Wire Guard	200	1	560
TP7845	Clear Globe	200	1	450
FLUORESCENT				
TP7870	Clear Globe, Wire Guard	13	1	462

Vapor Proof Lighting Incandescent

VAPOR PROOF COMPONENTS

Product Number	Description	Watts	Std. Unit Carton	Wt. Lbs. Per 100
PENDANT CAP, PORCELAIN SOCKET GASKET AND SCREWS				
TP7496	Grey, 1/2"	100	10	18
TP7497	Grey, 3/4"	100	10	18
TP7498	Grey, 1/2"	200	10	10
TP7499	Grey, 3/4"	200	10	10
CEILING BOX CAP, SOCKET GASKET AND SCREWS				
TP7447	Grey	100	10	12
TP7448	Grey	200	10	12
CEILING MOUNT BOX WITH GASKETS, PORCELAIN SOCKET AND SCREWS				
TP7450	Grey, 1/2"	100	10	19
TP7478	Grey, 3/4"	100	10	19
TP7451	Grey, 1/2"	200	10	19
TP7479	Grey, 3/4"	200	10	19
RIGHT ANGLE BRACKET GASKET, SOCKET, SCREWS				
TP7445	Grey	100	10	21
TP7446	Grey	200	6	12
RIGHT ANGLE BRACKET ATTACHED BOX, GASKET, SOCKET AND SCREWS				
TP7440	Grey, 1/2"	100	1	3
TP7441	Grey, 3/4"	100	1	3
TP7442	Grey, 1/2"	200	1	1.5
TP7443	Grey, 3/4"	200	1	1.5



VAPOR PROOF FIXTURE ACCESSORIES



TP7460 - TP7466



TP7468 - TP7472



TP7474, TP7475



TP7476



TP7477

Product Number	Description	Watts	Std. Unit Carton	Wt. Lbs. Per 100
TP7460	Glass Clear Globe, 130°F Max	100	12	98
TP7462	Glass Amber Globe	100	12	120
TP7463	Glass Blue Globe	100	12	120
TP7464	Glass Green Globe	100	12	120
TP7466	Glass Clear Globe	200	6	200
TP7468	Lexan Clear Prismatic	75	12	58.4
TP7469	Lexan Blue Prismatic	60	12	58.4
TP7470	Lexan Red Prismatic	75	12	58.4
TP7471	Lexan Amber Prismatic	75	12	58.4
TP7472	Lexan White	75	12	58.4
TP7474	Bayonet Mount Die-Cast Guard	100	12	108.4
TP7475	Wire Guard	200	6	183.4
TP7476	Clamp-On Wire Guard	100	12	62.5
TP7477	Adapter Plate	—	12	62.5

Weatherproof Lampholders

WEATHERPROOF LAMPHOLDERS AND ACCESSORIES

ZINC DIE-CAST CONSTRUCTION, UP TO 150 WATTS, WITH LAMP GASKET, UL LISTED

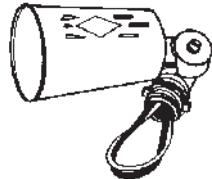

TP7162 – TP7165

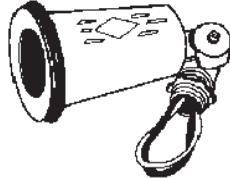

TP7166

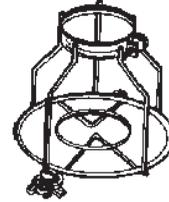

TP7176

Product Number	Description	Color	Std. Unit Carton	Wt. Lbs Per 100
TP7162	Universal Par Lampholder	Natural	36	47.2
TP7163	Universal Par Lampholder	Gray	36	47.2
TP7164	Universal Par Lampholder	White	36	47.2
TP7165	Universal Par Lampholder	Bronze	36	47.2
TP7166	Universal Par Lampholder With External Gasket	Gray	36	50
TP7170	External Gasket Only	—	100	3
TP7176	Clamp-On Guard	—	24	50

WEATHERPROOF LAMPHOLDERS AND ACCESSORIES

ZINC DIE-CAST CONSTRUCTION, UP TO 150 WATTS, WITH LAMP GASKET, UL LISTED

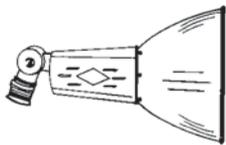

TP7178



TP7186

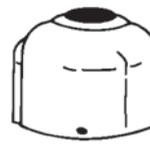

TP7188
(Aluminum)

Product Number	Description	Color	Std. Unit Carton	Wt. Lbs Per 100
TP7178	Par Lampholder With Reflector	Gray	6	166.7
TP7186	Portable Par Lampholder With 6' Cord	Gray	12	100
TP7188	2 1/2" Outside Diameter Pole Fitter with 1/2" Male Thread	Gray	24	50

WEATHERPROOF LAMPHOLDER COMBINATIONS

ZINC DIE-CAST CONSTRUCTION, WITH GASKETS, UL LISTED

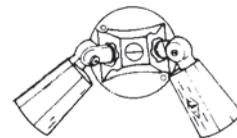

TP7330 – TP7332

Product Number	Description	Color	Std. Unit Carton	Wt. Lbs Per 100
TP7330	2 Par Lampholders and 3-Hole Round Cover	Gray	10	137.5
TP7331	2 Par Lampholders and 3-Hole Round Cover	White	10	137.5
TP7332	2 Par Lampholders and 3-Hole Round Cover	Bronze	10	137.5

Weatherproof Outdoor HID Luminaires

Luminarea™ Series Area Luminaires



Cooper Crouse-Hinds Luminarea Luminaires are ideally suited for general and security lighting indoors or outdoors. Area luminaires are available in 2 sizes in 70 to 175 watt metal halide and 70 to 150 watt high pressure sodium. The bronze epoxy powder coated housing is designed for an extended, trouble-free life. The housing is gasketed for raintight (NEMA 3R) locations. The prismatic polycarbonate lens is vandal resistant for even light distribution. Typical applications include parking garages, storage areas, stairwells, corridors and lobbies.

Key Features and Benefits

- Durable die cast aluminum housing for long product life.
- Architectural bronze powder paint finish for corrosive environments.
- Stainless steel hardware.
- Internal white reflector for maximum light output.
- Vandal resistant polycarbonate lens.
- Side and top plugged threaded entries for easy field wiring.
- High power factor ballast in multi-tap (120, 208, 240, 277 volt) or tri-tap (120, 277, 347 volt) configurations.
- Two housing sizes insure maximum utilization of space.
- Available in 70 to 175 watt metal halide or high pressure sodium versions.

Certifications and Compliances

- UL1598
- UL and cUL listed
- NEMA 3R raintight

Materials & Finishes

- Housing - Die Cast Aluminum
- Lens - Polycarbonate
- Gasket - Silicone
- Hardware - Stainless Steel

Ratings

- 70 to 175 watt metal halide and high pressure sodium.
- Multi-tap (120, 208, 240, 277 volts) or Tri-tap (120, 277, 347 volts)
- 480V

Ordering Information

High Pressure Sodium					
Watts	Voltage	Catalog Number	Description	Lamp Base	Ballast
70	120/208/240/277	WLPG70HPS/MT	8" × 8" Housing	Medium	HPF
70	120/277/347	WLPG70HPS/TT	8" × 8" Housing	Medium	HPF
100	120/208/240/277	WLPG100HPS/MT	12" × 12" Housing	Medium	HPF
100	120/277/347	WLPG100HPS/TT	12" × 12" Housing	Medium	HPF
150	120/208/240/277	WLPG150HPS/MT	12" × 12" Housing	Medium	HPF
150	120/277/347	WLPG150HPS/TT	12" × 12" Housing	Medium	HPF

Metal Halide					
Watts	Voltage	Catalog Number	Description	Lamp Base	Ballast
70	120/208/240/277	WLPG70MH/MT	8" × 8" Housing	Medium	HPF
70	120/277/347	WLPG70MH/TT	8" × 8" Housing	Medium	HPF
100	120/208/240/277	WLPG100MH/MT	12" × 12" Housing	Medium	HPF
100	120/277/347	WLPG100MH/TT	12" × 12" Housing	Medium	HPF
175	120/208/240/277	WLPG175MH/MT	12" × 12" Housing	Medium	HPF
175	120/277/347	WLPG175MH/TT	12" × 12" Housing	Medium	CWA

Lamp not included.

Weatherproof Outdoor HID Luminaires

Luminarea™ Series Floodlight Luminaires



Cooper Crouse-Hinds Luminarea floodlights are ideally suited for area and outdoor parking lot lighting. The floodlights are available in 3 housing sizes in 150 to 1000 watt metal halide or high pressure sodium. The bronze epoxy powder coated housing is designed for an extended, trouble-free life. The housing is gasketed for raintight (NEMA 3R) locations. Floodlights are available with an optional slip fitter or swivel bracket for mounting flexibility. Typical applications include parking lots, area lighting, street lighting, recreational lighting and security lighting.

Key Features and Benefits

- Durable die cast aluminum housing for long product life.
- Bronze powder paint finish for corrosive environments.
- Stainless steel hardware.
- Hinged lens for easy access to wiring and lamp chamber.
- Polished aluminum reflector maximizes light output.
- Side, bottom & rear plugged threaded entries for easy wiring.
- 150W & 175W fixture includes adjustable mounting bracket.
- 250 to 1000 watt fixtures must be ordered with separate slipfitter or or swivel bracket (see page 256).
- Three housing sizes insure maximum utilization of space.
- Available in 150 to 1000 watt metal halide or high pressure sodium versions.

Certifications and Compliances

- UL1598
- UL and cUL listed
- NEMA 3R raintight

Materials & Finishes

- Housing - Die Cast Aluminum
- Lens - Tempered Glass
- Gasket - Silicone
- Hardware - Stainless Steel

Ratings

- 150 to 1000 watt metal halide and high pressure sodium.
- 250 and 400 watt metal halide available with pulse start.
- Multi-tap (120, 208, 240, 277 volts) or Tri-tap (120, 277, 347 volts)
- 480V

Ordering Information

High Pressure Sodium					
Watts	Voltage	Catalog Number	Description	Lamp Base	Ballast
150	120/208/240/277	WLFL150HPS/MT ¹	Medium Housing	Medium	HPF
150	120/277/347	WLFL150HPS/TT ¹	Medium Housing	Medium	HPF
250	120/208/240/277	WLFL250HPS/MT ²	16" × 16" Housing	Mogul	CWA-HPF
250	120/277/347	WLFL250HPS/TT ²	16" × 16" Housing	Mogul	CWA
400	120/208/240/277	WLFL400HPS/MT ²	16" × 16" Housing	Mogul	CWA-HPF
400	120/277/347	WLFL400HPS/TT ²	16" × 16" Housing	Mogul	CWA
1000	120/208/240/277	WLFL1000HPS/MT ³	23" × 23" Housing	Mogul	CWA-HPF
1000	120/277/347	WLFL1000HPS/TT ³	23" × 23" Housing	Mogul	CWA

Metal Halide					
Watts	Voltage	Catalog Number	Description	Lamp Base	Ballast
175	120/208/240/277	WLFL175MH/MT ¹	Medium Housing	Medium	CWA
175	120/277/347	WLFL175MH/TT ¹	Medium Housing	Medium	CWA
250	120/208/240/277	WLFL250MH/MT ²	16" × 16" Housing	Mogul	CWA-HPF
250	120/208/240/277	WLFL250MH/MT-S828 ³	16" × 16" Housing, Pulse Start	Mogul	Pulse
250	120/277/347	WLFL250MH/TT ²	16" × 16" Housing	Mogul	CWA
400	120/208/240/277	WLFL400MH/MT ²	16" × 16" Housing	Mogul	CWA-HPF
400	120/208/240/277	WLFL400MH/MT-S828 ³	16" × 16" Housing, Pulse Start	Mogul	Pulse
400	120/277/347	WLFL400MH/TT ²	16" × 16" Housing	Mogul	CWA
1000	120/208/240/277	WLFL1000MH/MT ³	23" × 23" Housing	Mogul	CWA-HPF
1000	120/277/347	WLFL1000MH/TT ³	23" × 23" Housing	Mogul	CWA

Lamp not included.

1. 150W & 175W Floodlight - Comes with adjustable mounting bracket with 1/2" thread.

2. 250W & 400W Floodlight - Must buy swivel bracket or slipfitter separately

3. 1000W Floodlight - Must buy slipfitter separately

Weatherproof Outdoor HID Luminaires

Luminarea™ Series Wallpack Luminaires



Cooper Crouse-Hinds Luminarea wallpacks are ideally suited for security and perimeter lighting indoors and outdoors. Wallpacks are available in 3 housing sizes in 100 to 400 watt metal halide or high pressure sodium. The bronze epoxy powder coated housing is designed for an extended, trouble-free life. The housing is gasketed for raintight (NEMA 3R) locations. The prismatic glass lens is designed for optimal light distribution to minimize the total number of luminaires required. Typical applications include office buildings, stores, restaurants, warehouses, banks and parking garages.

Key Features and Benefits

- Durable die cast aluminum housing for long product life.
- Architectural bronze powder paint finish for corrosive environments.
- Stainless steel hardware.
- Hinged lens for easy access to wiring and lamp chamber.
- Glass prismatic lens provides superior light distribution.
- Top, side and rear plugged threaded entries for easy field wiring.
- High power factor ballast in multi-tap (120, 208, 240, 277 volt) or tri-tap (120, 277, 347 volt) configurations.
- Three housing sizes insure maximum utilization of space.
- Available in 100 to 400 watt metal halide or high pressure sodium versions.

Certifications and Compliances

- UL1598
- UL and cUL listed
- NEMA 3R raintight

Materials & Finishes

- Housing - Die Cast Aluminum
- Lens - Tempered Glass
- Gasket - Silicone
- Hardware - Stainless Steel

Ratings

- 100 to 400 watt metal halide and high pressure sodium.
- Multi-tap (120, 208, 240, 277 volts) or Tri-tap (120, 277, 347 volts)
- 480V

Ordering Information

High Pressure Sodium						
Watts	Voltage	Catalog Number	Description	Lamp Base	Ballast	
100	120/208/240/277	WLWP100HPS/MT	Small Housing	Medium	HPF	
100	120/277/347	WLWP100HPS/TT	Small Housing	Medium	HPF	
150	120/208/240/277	WLWP150HPS/MT	Medium Housing	Medium	HPF	
150	120/277/347	WLWP150HPS/TT	Medium Housing	Medium	HPF	
250	120/208/240/277	WLWP250HPS/MT	Large Housing	Mogul	CWA-HPF	
250	120/277/347	WLWP250HPS/TT	Large Housing	Mogul	CWA	
400	120/208/240/277	WLWP400HPS/MT	Large Deep Housing	Mogul	CWA	
400	120/277/347	WLWP400HPS/TT	Large Deep Housing	Mogul	CWA	

Metal Halide						
Watts	Voltage	Catalog Number	Description	Lamp Base	Ballast	
100	120/208/240/277	WLWP100MH/MT	Small Housing	Medium	HPF	
100	120/277/347	WLWP100MH/TT	Small Housing	Medium	HPF	
175	120/208/240/277	WLWP175MH/MT	Medium Housing	Medium	CWA-HPF	
175	120/277/347	WLWP175MH/TT	Medium Housing	Medium	CWA	
250	120/208/240/277	WLWP250MH/MT	Large Housing	Mogul	CWA-HPF	
250	120/208/240/277	WLWP250MH/MT-S828	Large Housing, Pulse Start	Mogul	Pulse	
250	120/277/347	WLWP250MH/TT	Large Housing	Mogul	CWA	
400	120/208/240/277	WLWP400MH/MT	Large Deep Housing	Mogul	CWA	
400	120/208/240/277	WLWP400MH/MT-S828	Large Deep Housing, Pulse Start	Mogul	Pulse	
400	120/277/347	WLWP400MH/TT	Large Deep Housing	Mogul	CWA	

Lamp not included.

Weatherproof Outdoor HID Luminaires

Luminarea™ Series Accessories

WALLPACKS

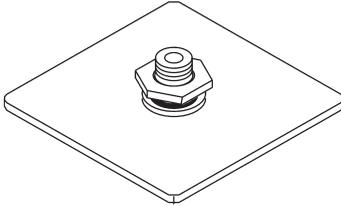

Mounting Plate

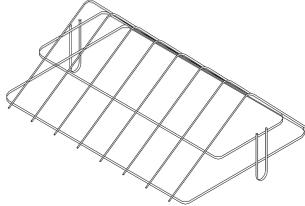

Wire Guards

FLOODLIGHTS

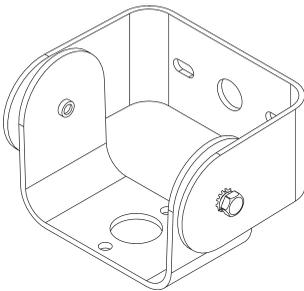

Swivel Bracket

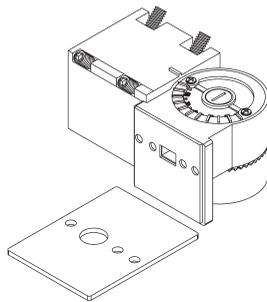

Slipfitters

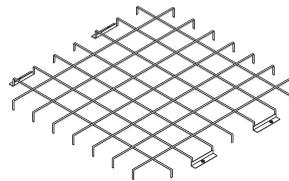

Wire Guards

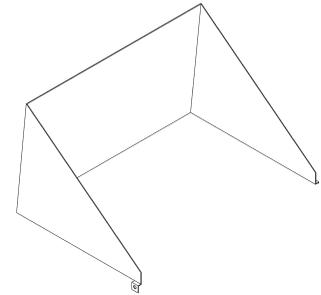

Glare Shields

Ordering Information

Accessories for Wallpacks & Area Luminaires	
Catalog Number	Description
WLWMP-1	Mounting Plate for 100W Wallpack & Area Luminaire
WLWPWG-1	Wire Guard for 100 W Wallpack
WLWPWG-2	Wire Guard for 150/175W Wallpack
WLWPWG-3	Wire Guard for 250 & 400W Wallpack

Accessories for Floodlights	
Catalog Number	Description
WLFLSB-3	Swivel Bracket for 250 & 400W Floodlight
WLFLSF-3	Slipfitter for 250 and 400W Floodlight
WLFLSF-4	Slipfitter for 1000W Floodlight
WLFLWG-3	Wire Guard for 250 & 400W Floodlight
WLFLWG-4	Wire Guard for 1000W Floodlight
WLFLGS-2	Glare Shield for 150/175W Medium Floodlight
WLFLGS-3	Glare Shield for 250 & 400W Floodlight
WLFLGS-4	Glare Shield for 1000W Floodlight

Weatherproof Outdoor HID Luminaires

Luminarea™ Series Dimensions & Weights

Area Luminaires (Inches)

Weight: 15lbs.

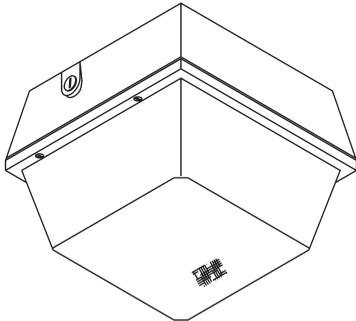

70W
8.75W x 7.5H x 8.75D

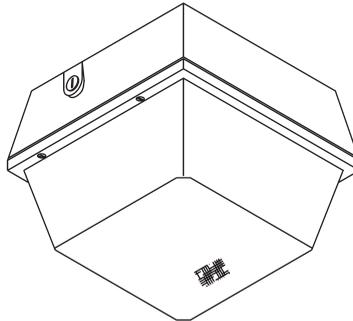

100W to 175W
12.25W x 8.5H x 12.25D

Floodlight Luminaires (Inches)

Weight: 15lbs.

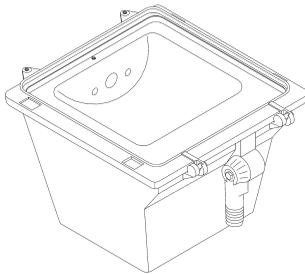

150W & 175W
9.0W x 6.75H x 5.75D

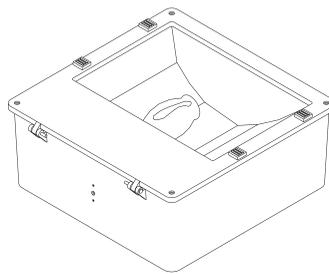

250W & 400W
16.0W x 16.0H x 7.25D

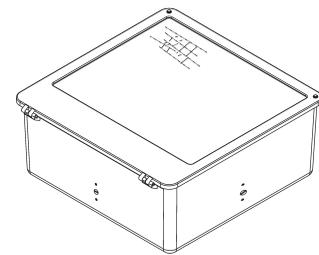

1000W
23.0W x 23.0H x 10.25D

Wallpack Luminaires (Inches)

Weight: 15lbs.

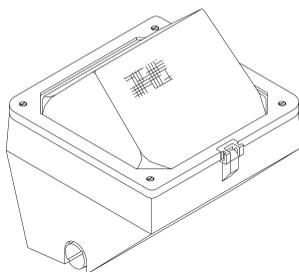

100W
8.5W x 9.375H x 7.0D

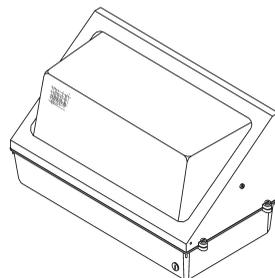

150W & 175W
13.0W x 9H x 7.25D

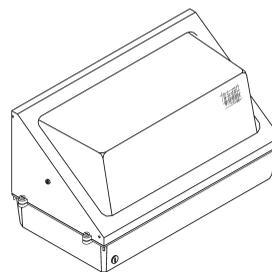

250W
18.0W x 9.0H x 9.75D

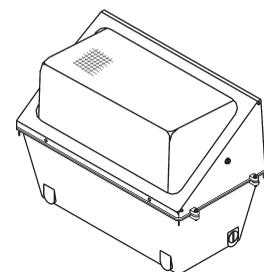

400W
18.0W x 9.0H x 12.75D

Garden Lights

ZINC DIE-CAST CONSTRUCTION, PORCELAIN SOCKET GLASS GLOBES, 3-20" WIRE LEADS, UL LISTED

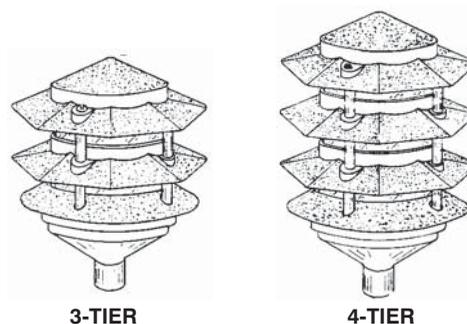

Product Number	Description	Color	Watts	Std. Unit Pkg.	Wt. Lbs Per 100
TP7700	3-Tier	Green	60	6	366.7
TP7701	3-Tier	Black	60	6	366.7
TP7702	3-Tier	Bronze	60	6	366.7
TP7703	3-Tier	White	60	6	366.7
TP7710	4-Tier	Green	100	6	416.7
TP7711	4-Tier	Black	100	6	416.7
TP7712	4-Tier	Bronze	100	6	416.7
TP7713	4-Tier	White	100	6	416.7
TP7720	4-Tier, Fluorescent	Green	7	6	433.3
TP7721	4-Tier, Fluorescent	Black	7	6	433.3
TP7722	4-Tier, Fluorescent	Bronze	7	6	433.3
TP7723	4-Tier, Fluorescent	White	7	6	433.3

GARDEN LIGHT ACCESSORIES

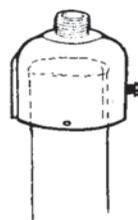

TP7188



TP7770

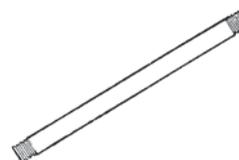

TP7771 - TP7774

Product Number	Description	Color	Std. Unit Pkg.	Wt. Lbs Per 100
TP7188	2½" Diameter Pole Top Filter with ½" Male Thread (Aluminum)	Gray	24	50
TP7770	7" Ground Spike with Male Thread (Zinc)	—	12	33.3
TP7771	12" Heavy Duty Stem	Green	24	83.4
TP7773	12" Heavy Duty Stem	Bronze	24	83.4
TP7774	18" Heavy Duty Stem	Green	12	150

Photoelectric Lighting

PHOTOELECTRIC LIGHTING CONTROLS



TP7920

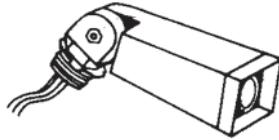

TP7924 – TP7925



TP7927 – TP7928

Product Number	Description	Std. Unit Pkg.	Wt. Lbs Per 100
TP7920	300W Photo Cell With Plate 120V	10	50
TP7924	300W Swivel Photo Cell 120V	10	8.3
TP7925	1200W Swivel Photo Cell 120V	10	8.3
TP7927	300W Photo Cell 120V	10	8.3
TP7928	1000W Photo Cell 208-277V	10	8.3

CLOSURE PLUGS – ZINC DIE-CAST†

Product Number	Description	Std. Unit Pkg.	Color	Wt. Lbs Per 100
TP7940	1/2"	100	Gray	1.5
TP7942	1/2"	100	Bronze	1.5
TP7944	3/4"	50	Gray	2.1

† CSA Certified

DIMENSIONAL DATA

Single Gang Boxes

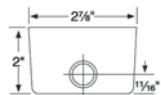
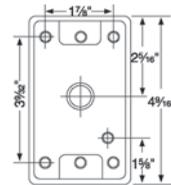

TP7010 – TP7071

Single Gang Deep Boxes

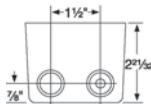
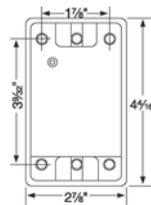

TP7074 – TP7082

Two Gang Boxes

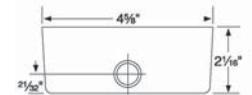
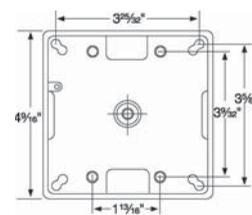

TP7086 – TP7122

Dimensional Data

Two Gang Deep Boxes

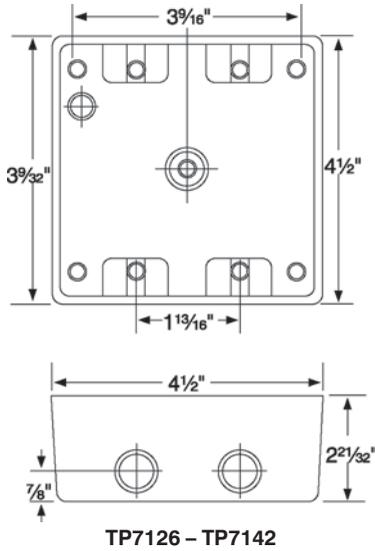

Round Boxes

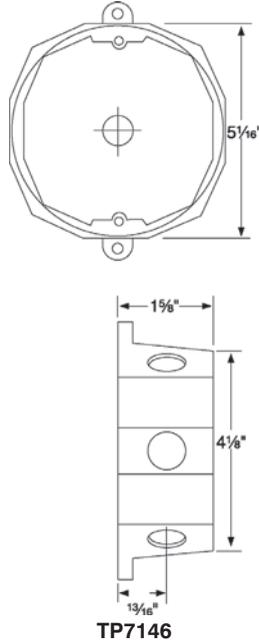

Extension Rings and Flanged Boxes

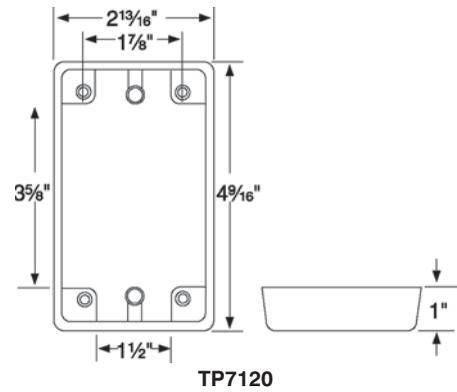

Extension Rings and Flanged Boxes

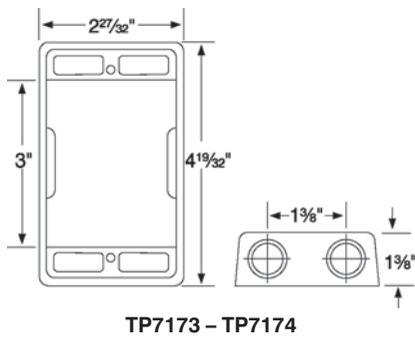

Single Gang, Duplex Receptacle Covers

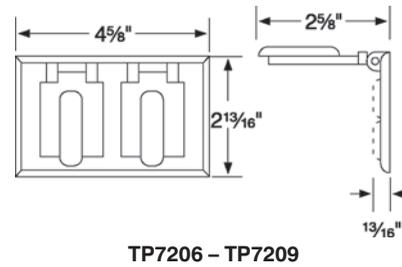

Single Gang, Single Receptacle Covers - Vertical Mount

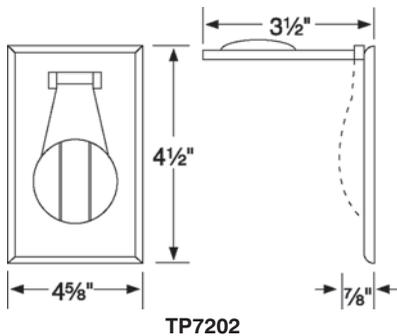

Two Gang, Single Receptacle Covers

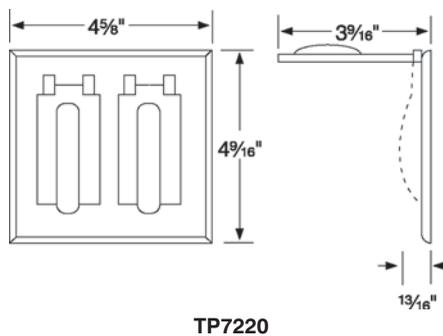

Single Gang, Duplex Receptacle Covers - Vertical Mount

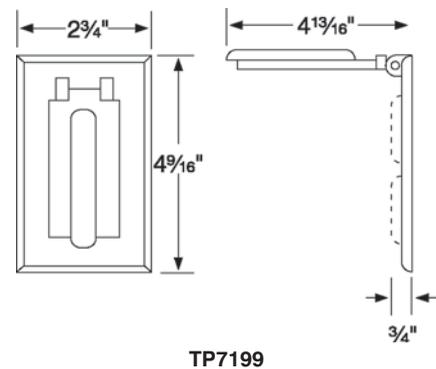

Dimensional Data

Two Gang, Duplex Receptacle Covers

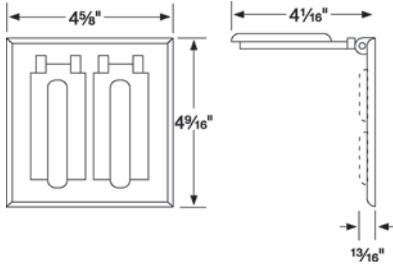

TP7228

Single Gang, GFCI Covers
Horizontal Mount

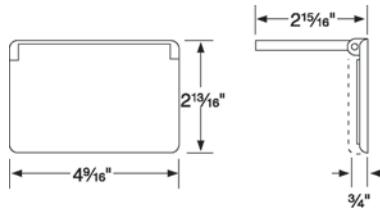

TP7236 - TP7238

Single Gang, GFCI Covers
Vertical Mount

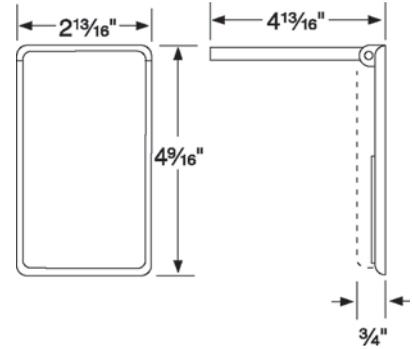

TP7240 - TP7242

Two Gang, GFCI Covers

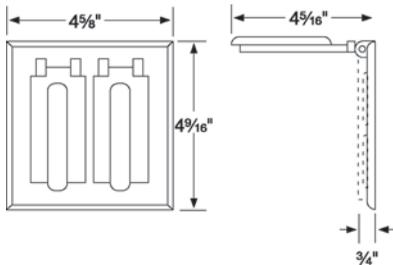

TP7248

Blank Covers

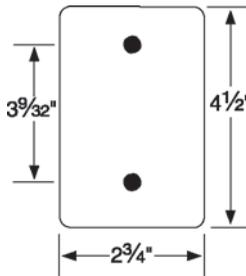

TP7292 - TP7294

Blank Covers

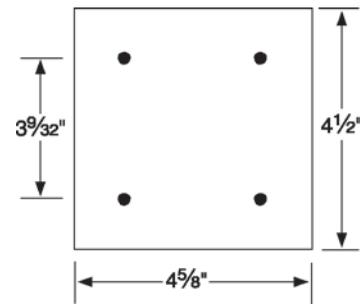

TP7296 - TP7298

Blank Covers

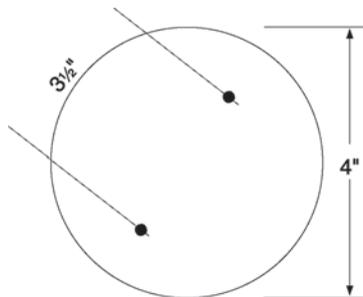

TP7158

Single Gang, Switch Covers
Vertical Mount

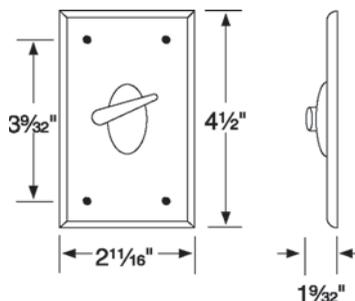

TP7256

Lampholders

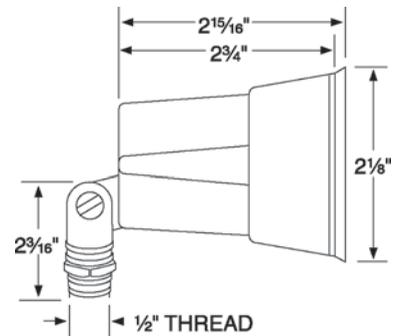

TP7162 - TP7165

Hooded Lampholder

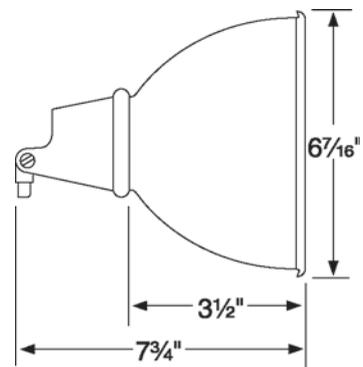

TP7178

Rectangular Lampholder Covers

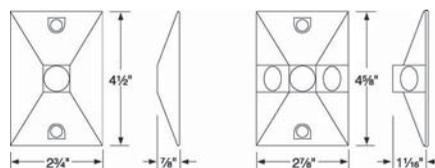

TP7312 - TP7322

Round Lampholder Covers

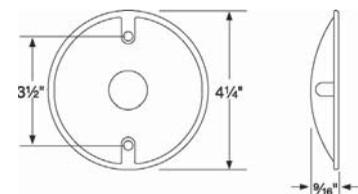

TP7300 - TP7310

Dimensional Data

Lampholder Assemblies

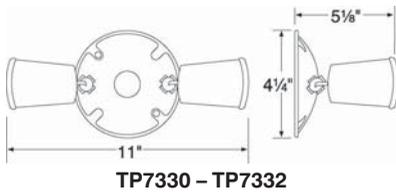

Garden Lights

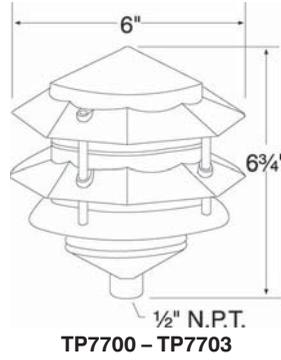

Garden Lights

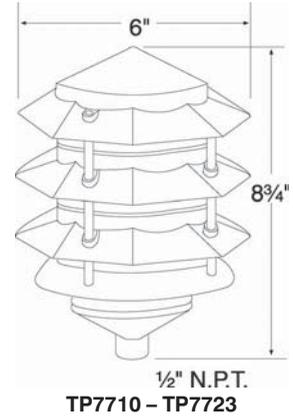

Spike Lights

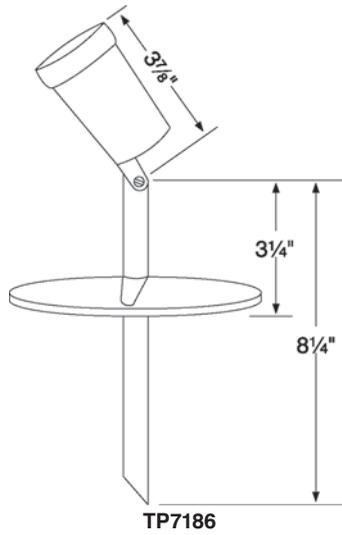

Dimensional Data

VAPOR PROOF DIMENSIONS 200 WATT

Product Number	Length	Overall Width	Depth
TP7830	12½"	5½"	6⅜"
TP7840	12½"	5½"	8"
TP7820	7½"	4½"	—
TP7810	11½"	5½"	—
TP7800	10¾"	5½"	—

100 WATT DIMENSIONS

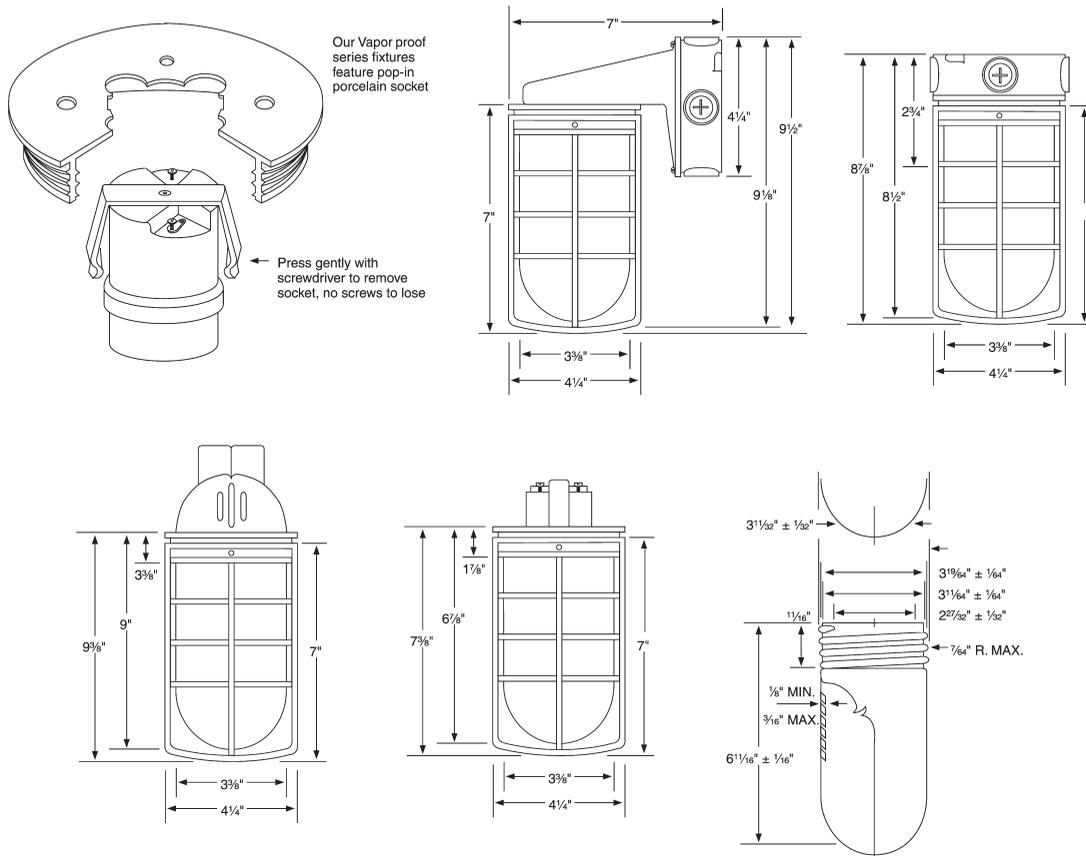

Vapor Proof Lighting

Our Glass Globe Vapor proof fixtures comply with the latest U.L. requirements for standard 1598, for enclosed and gasketed incandescent fixtures.

Suitable For Wet Locations

Corrosion resistant, rugged die-cast construction castings. These lights are designed for indoor and outdoor industrial or commercial locations, gasketing allows their use in outdoor locations.

Designed by our engineers for fast, easy on the job site installation. Cooper Crouse-Hinds Vapor proof series fixtures are perfect for permanent or temporary lighting. Screw on cast guards are supplied with allen head set screws locking it in place to help prevent vandalism. Unit features snap-in, snap-out, copper screw shell porcelain sockets with screws backed out.

- Fixtures may be purchased complete or as components.
 - Fixtures constructed of Die-Cast Aluminum, Guards are Zinc Die-Cast.
 - Heat Resistant Clear Globe Available on 100 watt series.
 - Wire Guard Available.
- Clear glass is standard, colors are available, plastic (polycarbonate) globes which are virtually unbreakable are available in colors and are used as an alternative to glass globe-guard combinations (not recommended to exceed 60 watts).

Service Entrance and Grounding Fittings

- Service Entrance Elbows – Aluminum
- Entrance Caps
- Service Entrance Cable Connectors
- Perforated Strap
- Ground Straps
- Ground Clamp

SERVICE ENTRANCE FITTINGS

SERVICE ENTRANCE ELBOWS – ALUMINUM

Gasketed

UL File No. E-19189



Cat. #	Size	Unit Qty.	Std. Pkg.	Wgt. Lbs. Per 100
SLB1	1/2"	10	50	25
SLB2	3/4"	10	50	30
SLB3	1"	5	25	51
SLB4	1 1/4"	2	10	83
SLB5	1 1/2"	1	5	117
SLB6	2"	1	5	192

SERVICE ENTRANCE CAPS FOR EMT AND RIGID CONDUIT – ALUMINUM

Clamp Type

UL File No. E-22133



Cat. #	Size	Holes in Insulator	Unit Qty.	Std. Pkg.	Wgt. Lbs. Per 100
EH1**	1/2"	4-19/64"	10	50	52
EH2**	3/4"	2-3/8 3-13/32"	10	50	60
EH3	1"	2-7/16" 3-1/2"	5	25	48
EH4	1 1/4"	2-7/16" 3-5/8"	5	25	50
EH5	1 1/2"	2-19/32" 1-7/16" 3-3/4"	3	15	110
EH6	2"	2-3/4" 3-1" 1-17/32"	5	5	140
EH7	2 1/2"	3-7/8" 1-1" 3-1-5/16"	1	1	400
EH8	3"	4-1-1/8" 3-1-3/4"	1	1	650
EH9	3 1/2"	4-1-1/8" 3-1-3/4"	1	1	650
EH10	4"	4-1-1/8" 3-1-3/4"	1	1	600

** Zinc

Series 5 Combination Conduit Outlet Bodies For EMT and IMC or Rigid Conduit

- Combination Conduit Outlet Bodies
- Die Cast Aluminum
- Available in SnapPack™
- Stainless Steel Cover Screws

EMT CONDUIT OUTLET BODIES – CAST ALUMINUM†

UL File No. E-15022

Applications

Die cast aluminum Series 5 Conduit Bodies are used in conduit systems to:

- Act as pull outlets for conductors being installed
- Provide openings for making splices and taps in conductors
- Act as mounting outlets for lighting fixtures and wiring devices
- Connect conduit sections
- Provide taps for branch conduit runs
- Make 90 degree bends in conduit runs
- Provide for access to conductors for maintenance and future system changes
- Conduit bodies are supplied with threaded hubs for use with IMC or Rigid conduit and set screws for use with EMT conduit

Type C



Cat. #	Trade Size	Internal Vol. in Cu. In.	Unit Qty	Std. Pkg	Wt Lbs. Per 100
C15-MT	1/2"	4.25	10	100	27
C25-MT	3/4"	7.0	10	50	40
C35-MT	1"	10.8	5	25	64
C45-MT	1 1/4"	32.3	2	10	165
C55-MT	1 1/2"	32.3	2	10	150
C65-MT	2"	64.0	1	5	270

† SnapPack™ EMT conduit bodies consisting of body and cover assembled and shipped together, change "-MT" to "-MTC" in catalog number i.e.: LB25-MTC

Type LL



Cat. #	Trade Size	Internal Vol. in Cu. In.	Unit Qty	Std. Pkg	Wt Lbs. Per 100
LL15-MT	1/2"	4.25	10	100	27
LL25-MT	3/4"	7.0	10	50	40
LL35-MT	1"	10.8	5	25	64
LL45-MT	1 1/4"	32.3	2	10	165
LL55-MT	1 1/2"	32.3	2	10	150
LL65-MT	2"	64.0	1	5	270

† SnapPack™ EMT conduit bodies consisting of body and cover assembled and shipped together, change "-MT" to "-MTC" in catalog number i.e.: LB25-MTC

Type LR



Cat. #	Trade Size	Internal Vol. in Cu. In.	Unit Qty	Std. Pkg	Wt Lbs. Per 100
LR15-MT	1/2"	4.25	10	100	27
LR25-MT	3/4"	7.0	10	50	40
LR35-MT	1"	10.8	5	25	64
LR45-MT	1 1/4"	32.3	2	10	165
LR55-MT	1 1/2"	32.3	2	10	150
LR65-MT	2"	64.0	1	5	270

† SnapPack™ EMT conduit bodies consisting of body and cover assembled and shipped together, change "-MT" to "-MTC" in catalog number i.e.: LB25-MTC

Type T



Cat. #	Trade Size	Internal Vol. in Cu. In.	Unit Qty	Std. Pkg	Wt Lbs. Per 100
T15-MT	1/2"	4.25	10	100	27
T25-MT	3/4"	7.0	10	50	40
T35-MT	1"	10.8	5	25	64
T45-MT	1 1/4"	32.3	2	10	165
T55-MT	1 1/2"	32.3	2	10	150
T65-MT	2"	64.0	1	5	270

† SnapPack™ EMT conduit bodies consisting of body, cover and gasket assembled and shipped together, change "-MT" to "-MTC" in catalog number i.e.: LB25-MTC

Type LB



Cat. #	Trade Size	Internal Vol. in Cu. In.	Unit Qty	Std. Pkg	Wt Lbs. Per 100
LB15-MT	1/2"	4.25	10	100	27
LB25-MT	3/4"	7.2	10	50	40
LB35-MT	1"	10.8	5	25	56
LB45-MT	1 1/4"	28.8	2	10	132
LB55-MT	1 1/2"	32.3	2	10	175
LB65-MT	2"	66.5	1	5	240
LB75-MT*	2 1/2"	Over 100	1	1	450
LB85-MT*	3"	Over 100	1	1	460
LB95-MT*	3 1/2"	Over 100	1	1	800
LB105-MT*	4"	Over 100	1	1	900

† SnapPack™ EMT conduit bodies consisting of body, cover and gasket assembled and shipped together, change "-MT" to "-MTC" in catalog number i.e.: LB25-MTC

* Fittings greater than 2" are set-screw only (not combination threaded & set-screw)

Covers, Aluminum

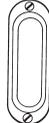

Cat. #	Conduit Size	Unit Quantity	Standard Package	Weight Lbs. Per 100
150	1/2"	50	250	5
250	3/4"	50	250	6
350	1"	50	250	20
450	1 1/4"-1 1/2"	50	50	25
650	2"	25	25	25
850D	2 1/2"-3"	10	10	78
950D	3 1/2"-4"	5	5	140

Gaskets, Neoprene



Cat. #	Conduit Size	Unit Quantity	Standard Package	Weight Lbs. Per 100
GASK015N	1/2"	100	100	2
GASK025N	3/4"	100	100	2
GASK035N	1"	50	50	3
GASK045N	1 1/4"-1 1/2"	50	50	6
GASK065N	2"	25	25	10
GASK085N	2 1/2"-3"	10	10	20
GASK095N	3 1/2"-4"	10	10	30

Series 5 Conduit Outlet Bodies For Rigid/IMC Conduit

- Rigid Conduit Outlet Bodies
- Die Cast Aluminum
- Available in SnapPack™†

RIGID CONDUIT OUTLET BODIES – CAST ALUMINUM						
Type C †						
						
						
						
Cat. #	Trade Size	Internal Volume in Cubic Inches	Unit Qty.	Std. Pkg.	Weight Lbs. Per 100	
C15	1/2"	4.25	10	100	27	
C25	3/4"	7.0	10	50	40	
C35	1"	10.8	5	25	64	
C45	1 1/4"	32.3	2	10	165	
C55	1 1/2"	32.3	2	10	150	
C65	2"	64.0	1	5	270	
C75	2 1/2"	Over 100	1	1	500	
C85	3"	Over 100	1	1	600	
C95*	3 1/2"	Over 100	1	1	900	
C105*	4"	Over 100	1	1	1000	
*Not UL Listed						
Type LL †						
						
						
						
Cat. #	Trade Size	Internal Volume in Cubic Inches	Unit Qty.	Std. Pkg.	Weight Lbs. Per 100	
LL15	1/2"	4.25	10	100	30	
LL25	3/4"	7.0	10	50	48	
LL35	1"	10.8	5	25	64	
LL45	1 1/4"	32.3	2	10	140	
LL55	1 1/2"	32.3	2	10	160	
LL65	2"	63.0	1	5	270	
LL75	2 1/2"	Over 100	1	1	500	
LL85	3"	Over 100	1	1	600	
LL95	3 1/2"	Over 100	1	1	900	
LL105	4"	Over 100	1	1	1000	
Type LR †						
						
						
						
Cat. #	Trade Size	Internal Volume in Cubic Inches	Unit Qty.	Std. Pkg.	Weight Lbs. Per 100	
LR15	1/2"	4.25	10	100	26	
LR25	3/4"	7.0	10	50	48	
LR35	1"	10.8	5	25	64	
LR45	1 1/4"	32.3	2	10	140	
LR55	1 1/2"	32.3	2	10	160	
LR65	2"	63.0	1	5	260	
LR75	2 1/2"	Over 100	1	1	500	
LR85	3"	Over 100	1	1	600	
LR95	3 1/2"	Over 100	1	1	900	
LR105	4"	Over 100	1	1	1000	
Type T †						
						
						
						
Cat. #	Trade Size	Internal Volume in Cubic Inches	Unit Qty.	Std. Pkg.	Weight Lbs. Per 100	
T15	1/2"	4.25	10	100	32	
T25	3/4"	7.0	10	50	46	
T35	1"	10.8	5	25	70	
T45	1 1/4"	32.3	2	10	175	
T55	1 1/2"	32.3	2	10	185	
T65	2"	64.0	1	2	300	
T75	2 1/2"	Over 100	1	1	550	
T85	3"	Over 100	1	1	650	
T95*	3 1/2"	Over 100	1	1	950	
T105*	4"	Over 100	1	1	1050	
*Not UL Listed						

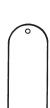
Type LB †						
						
						
						
Cat. #	Trade Size	Internal Volume in Cubic Inches	Unit Qty.	Std. Pkg.	Weight Lbs. Per 100	
LB15	1/2"	4.25	10	100	27	
LB25	3/4"	7.2	10	50	40	
LB35	1"	10.8	5	25	56	
LB45	1 1/4"	28.8	2	10	132	
LB55	1 1/2"	32.3	2	10	175	
LB65	2"	66.5	1	5	240	
LB75	2 1/2"	Over 100	1	1	450	
LB85	3"	Over 100	1	1	460	
LB95	3 1/2"	Over 100	1	1	800	
LB105	4"	Over 100	1	1	900	
Covers, Aluminum						
						
						
						
Cat. #	Conduit Size	Unit Quantity	Standard Package	Weight Lbs. Per 100		
150	1/2"	50	250	5		
250	3/4"	50	250	6		
350	1"	50	250	20		
450	1 1/4"-1 1/2"	50	50	25		
650	2"	25	25	25		
850D	2 1/2"-3"	10	10	78		
950D	3 1/2"-4"	5	5	140		
Gaskets, Neoprene						
						
Cat. #	Conduit Size	Unit Quantity	Standard Package	Weight Lbs. Per 100		
GASK015N	1/2"	100	100	2		
GASK025N	3/4"	100	100	2		
GASK035N	1"	50	50	3		
GASK045N	1 1/4"-1 1/2"	50	50	6		
GASK065N	2"	25	25	10		
GASK085N	2 1/2"-3"	10	10	20		
GASK095N	3 1/2"-4"	10	10	30		

Options:

†SnapPack™ pre-packaged body, cover and neoprene gasket add suffix CGN ie. LB25-CGN

Conduit Outlet Bodies Series 5 Dimensions

- Rigid and combination Rigid or IMC and EMT Conduit Outlet Bodies
- Die Cast Aluminum

Type LB Dimensions – Threaded & Set Screw Conduit

Size	A	B	C	D	E	F
1/2"	1 1/32"	1 57/64"	1/2"	2 11/64"	4 13/32"	1 5/32"
3/4"	1 39/64"	4 49/64"	3/4"	2 7/16"	5 1/8"	1 3/8"
1"	1 3/4"	5 3/8"	1"	2 3/4"	5 15/16"	1 23/32"
1 1/4"	2 39/64"	7 15/64"	1 1/4"	3 35/64"	7 7/8"	2 15/64"
1 1/2"	2 19/32"	7 17/64"	1 1/2"	3 23/32"	7 7/8"	2 3/8"
2"	3 19/64"	9 33/64"	2"	4 1/4"	10 15/64"	2 29/32"
2 1/2"	4 1/2"	12 3/16"	2 1/2"	5 5/32"	12 3/4"	3 13/32"
3"	4 19/32"	12 17/64"	3"	5 21/32"	12 49/64"	4 1/64"
3 1/2"	5 39/64"	15 1/32"	3 1/2"	6 61/64"	15 35/64"	5 5/32"
4"	5 39/64"	15 1/32"	4"	6 61/64"	15 39/64"	5 9/32"

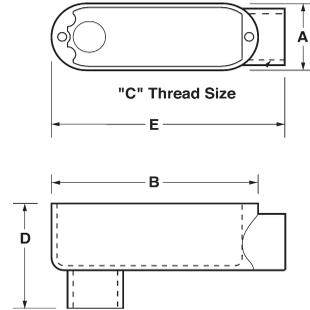

Type C Dimensions – Threaded & Set Screw Conduit

Size	A	B	C	D	E	F
1/2"	1 5/16"	3 27/32"	1/2"	1 1/2"	4 27/32"	1 1/8"
3/4"	1 17/32"	4 19/32"	3/4"	1 5/8"	5 1/64"	1 5/16"
1"	1 3/4"	5 1 1/32"	1"	1 29/32"	6 1/2"	1 1/2"
1 1/4"	2 17/32"	7 1/4"	1 1/4"	2 3/4"	8 1/2"	2 1/4"
1 1/2"	2 17/32"	7 1/4"	1 1/2"	2 3/4"	8 1/2"	2 1/4"
2"	2 7/32"	9 7/16"	2"	3 13/32"	10 3/4"	2 3/4"
2 1/2"	4 1/2"	12 1/4"	2 1/2"	4 1/2"	13"	4 1/2"
3"	4 1/2"	12 1/4"	3"	4 1/2"	13"	4 1/2"
3 1/2"	5 1/2"	15"	3 1/2"	5 9/16"	16 5/16"	5 1/2"
4"	5 1/2"	15"	4"	5 9/16"	16 5/16"	5 1/2"

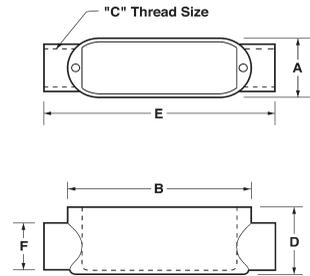

Type LL Dimensions – Threaded & Set Screw Conduit

Size	A	B	C	D	E	F
1/2"	1 3/32"	3 7/8"	1/2"	2"	4 9/32"	1 13/32"
3/4"	1 1/4"	4 21/32"	3/4"	2 11/32"	5 1/8"	1 13/32"
1"	1 1/2"	5 23/64"	1"	2 1/2"	5 99/64"	1 7/8"
1 1/4"	2 1/4"	7 17/64"	1 1/4"	3 13/32"	7 55/64"	2 7/8"
1 1/2"	2 1/4"	7 17/64"	1 1/2"	3 13/32"	7 55/64"	2 7/8"
2"	2 3/4"	9 15/32"	2"	3 27/32"	10 13/64"	3 27/64"
2 1/2"	4 5/8"	12 1/4"	2 1/2"	5 3/4"	13"	4 1/2"
3"	4 5/8"	12 1/4"	3"	5 3/4"	13"	4 1/2"
3 1/2"	5 7/16"	15"	3 1/2"	6 1/8"	16 5/16"	5 9/16"
4"	5 7/16"	15"	4"	6 1/8"	16 5/16"	5 9/16"

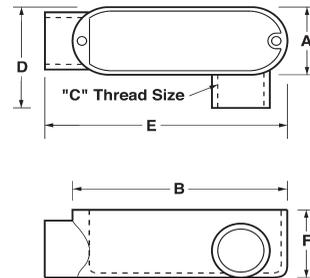

Type LR Dimensions – Threaded & Set Screw Conduit

Size	A	B	C	D	E	F
1/2"	1 7/64"	3 7/8"	1/2"	2"	4 9/32"	1 13/32"
3/4"	1 1/4"	4 21/32"	3/4"	2 11/32"	5 1/8"	1 41/64"
1"	1 1/2"	5 23/64"	1"	2 1/2"	5 99/64"	1 7/8"
1 1/4"	2 1/4"	7 17/64"	1 1/4"	3 13/32"	7 55/64"	2 7/8"
1 1/2"	2 1/4"	7 17/64"	1 1/2"	3 13/32"	7 55/64"	2 7/8"
2"	2 3/4"	9 15/32"	2"	3 27/32"	10 13/64"	3 27/64"
2 1/2"	4 7/16"	12 1/4"	2 1/2"	5 13/16"	12 1/4"	4 1/2"
3"	4 5/8"	12 1/4"	3"	5 13/16"	12 1/4"	4 1/2"
3 1/2"	5 7/16"	15"	3 1/2"	6 1/8"	15"	6 1/4"
4"	5 7/16"	15"	4"	6 1/8"	15"	6 1/4"

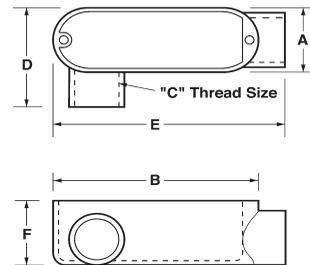

Type T Dimensions – Threaded & Set Screw Conduit

Size	A	B	C	D	E	F
1/2"	1 5/16"	3 27/32"	1/2"	1 3/8"	4 27/32"	2 1/16"
3/4"	1 17/16"	4 39/64"	3/4"	1 41/64"	5 19/32"	2 11/32"
1"	1 25/32"	5 3/8"	1"	1 29/32"	6 1/2"	2 19/32"
1 1/4"	2 1/2"	7 1/4"	1 1/4"	2 3/4"	8 1/2"	3 39/64"
1 1/2"	2 1/2"	7 1/4"	1 1/2"	2 3/4"	8 1/2"	3 35/64"
2"	3 1/4"	9 7/16"	2"	3 27/64"	10 13/16"	4 3/64"
2 1/2"	4 1/2"	12 1/4"	2 1/2"	4 1/2"	13"	5 25/32"
3"	4 1/2"	12 1/4"	3"	4 1/2"	13"	5 25/32"
3 1/2"	5 1/2"	15"	3 1/2"	5 9/16"	16 5/16"	6 13/16"
4"	5 1/2"	15"	4"	5 9/16"	16 5/16"	6 13/16"

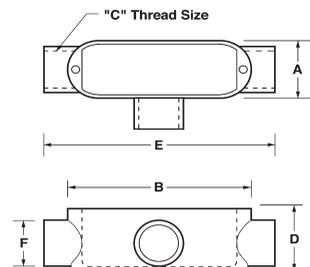

Junction Boxes

Application and Selection

Application:

Junction boxes, designed for hazardous and non-hazardous locations, are used in a variety of industries to perform the following functions:

- as a pull box
- to provide enclosures for splices and taps
- as a mounting box for multi-device control stations
- for housing apparatus, instruments, and other devices

Considerations for Selection:

- Environmental location – the physical location of the junction box will call for proper construction of the box to meet National Electrical Code requirements and

will affect the material and finish needed to meet weather and corrosive conditions, if present.

- Number and size of conductors – combined with the function to be performed (i.e., splicing, pull box), determines the amount of space needed, and therefore, the required physical dimensions of the box.
- Conduit layout – determines the number, size, and location of the conduit openings in the box. It will also determine the type of mounting required (i.e., flush or surface positioning of the box).
- Flexibility required – if changes in the electrical system are anticipated, the box chosen should be easily adaptable, either by construction (i.e., detachable hub plates) or size to the future system.

Options and Accessories:

A wide variety of options and accessories for special application are available for the various junction box families. These can be selected once the type of junction box has been determined. These options are shown on the individual pages. Some of the options available include:

- Special covers
- Hinged covers
- Materials and finishes
- Equipment mounting plates
- Openings for control station and other device mounting
- *Corro-free*[™] epoxy powder coat – information available on request

Quick Selector Chart

Junction Boxes	Environmental Capability/Type Designation	Size Range † L, W, D Inside	Max. Conduit Opening Size	Mtg.	Type of Conduit Opening	Cover Type	Page No.
WAB	Raintight/Type 3, Dust-tight/Type 12	4 x 4 x 2 to 24 x 24 x 8	5	Surface	Drilled and tapped, slip holes	Unflanged	111
WCB	Raintight/Type 3, Watertight/Type 4, Dust-tight/Type 12	4 x 4 x 2 to 24 x 24 x 8	5	Surface	Drilled and tapped, slip holes	Overlapping	112
WJB	Raintight/Type 3, Watertight/Type 4	4 x 4 x 3 to 36 x 24 x 24	6	Surface	Drilled and tapped, slip holes	Flanged	113
WJBF	Raintight/Type 3, Watertight/Type 4	4 x 4 x 4 to 36 x 24 x 24	6	Flush	Drilled and tapped, slip holes	External flanged recessed sidewalk	114
WEB	Raintight/Type 3	4 x 4 x 3 to 36 x 36 x 12	6	Flush	Drilled and tapped, slip holes	Internal Flanged	115

† Length and width are inside dimensions. Depth is inside dimension without cover.

Lightning Service[™] Delivery Identification – Looking for junction boxes to meet tight deadlines? Then specify Lightning Service. All products available with Lightning Service delivery will be marked with a checkmark. Look for pages with the Lightning Service Logo located at the top of the page.

Lightning Service is available for over 90 of the most popular size boxes in five different styles.

Shipped within 24 hours: All enclosures marked with a check mark are available in 24 hours without drilled and tapped openings or a mounting plate.

Shipped within 72 hours: All enclosures marked with a check mark are available in 72 hours with standard drilled and tapped openings and/or a mounting plate.



In Canada: Enclosures without openings or mountings plate shipped within 1 week. Enclosures with standard openings or mounting plate shipped within 2 weeks

WAB Junction Boxes

Heavy Duty

Unflanged for Surface Mounting

See ordering info. on following pages
See dimensions on following pages

Dust-proof
Weatherproof



Application:

Where a heavy duty dustproof or weatherproof enclosure is desired, WAB boxes are installed in conduit system to:

- act as pull box for conductors
- provide openings and space for making splices and taps in conductors
- provide for branch conduit runs
- provide access to conductors for maintenance and future system changes
- enclose and protect electrical devices

Features:

- Flat neoprene gasket cemented to the cover.
- Wide range of drilled and tapped and slip hole conduit entrance sizes and locations permits extreme flexibility of use in conduit system.
- Internal equipment mounting pads available blind tapped for 1/4" – 20 mounting screws.
- Blind tapped into internal mounting pads.
- Mounting straps are standard on all boxes.

Standard Materials:

- Feraloy® iron alloy body
- Heavy-gauge steel cover
- Neoprene gaskets
- Stainless steel cover screws
- Steel mounting straps

Standard Finishes:

- Feraloy iron alloy and heavy gauge steel – hot dip galvanized

Options:

- Factory installed mounting plate... add suffix –MP.
- See Ordering Information, beginning pg. 316 for:
 - Drilled and tapped conduit holes
 - Slip holes

Size Ranges:

- 4" x 4" x 2" to 24" x 24" x 8"

Certifications and Compliances:

- UL Standard: 50
- Dust-proof
- Weatherproof
- H20 Vehicle Load Rating *

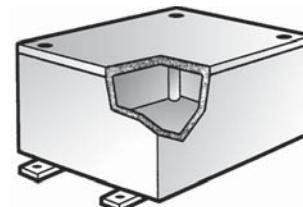

Flat Covers

Cat. #	Wall Thickness (in.)	Length (in.)	Width (in.)	Depth (in.)	Lightning Service
WAB040402	5/32	4	4	2	✓
WAB040403	3/16	4	4	3	✓
WAB040404	1/4	4	4	4	✓
WAB050503	1/4	5	5	3	✓
WAB050504	1/4	5	5	4	✓
WAB060403	1/4	6	4	3	✓
WAB060404	7/32	6	4	4	✓
WAB060603	1/4	6	6	3	✓
WAB060604	3/16	6	6	4	✓
WAB060606	9/32	6	6	6	✓
WAB080403	5/16	8	4	3	✓
WAB080604	7/32	8	6	4	✓
WAB080606	5/16	8	6	6	✓
WAB080804	5/16	8	8	4	✓
WAB080806	5/16	8	8	6	✓
WAB080808	5/16	8	8	8	✓
WAB090604	5/16	9	6	4	✓
WAB100604	1/4	10	6	4	✓
WAB100804	1/4	10	8	4	✓
WAB100806	9/32	10	8	6	✓
WAB101006	1/4	10	10	6	✓
WAB120604	9/32	12	6	4	✓
WAB120606	9/32	12	6	6	✓
WAB120806	9/32	12	8	6	✓
WAB120808	3/8	12	8	8	✓
WAB121204	9/32	12	12	4	✓
WAB121206	9/32	12	12	6	✓
WAB121208	9/32	12	12	8	✓
WAB160606	1/4	16	6	6	✓
WAB161208	5/16	16	12	8	✓
WAB181206	5/16	18	12	6	✓
WAB181208	5/16	18	12	8	✓
WAB181210	3/8	18	12	10	✓
WAB181806	3/8	18	18	6	✓
WAB181812	7/16	18	18	12	✓
WAB241212	7/16	24	12	12	✓
WAB242408	1 1/32	24	24	8	✓

* Self certify to H20 vehicle load rating equivalent to 16,000 lbs. on cover center.

✓ – available with Lightning Service™

WCB Junction Boxes

Heavy Duty

Overlapping Cover for Surface Mounting

See ordering info. on following pages
See dimensions on following pages

Dust-tight
Weatherproof
Watertight
Raintight



Application:

Where a heavy duty dust-tight, weatherproof, raintight, or watertight enclosure is desired, WCB boxes are installed in conduit systems to:

- act as pull box for conductors
- provide openings and space for making splices and taps in conductors
- provide for branch conduit runs
- provide access to conductors for maintenance and future system changes
- enclose and protect electrical devices

Features:

- Flat neoprene gasket cemented to cover.
- Overlapping cover sheds environment.
- Wide range of drilled and tapped and slip hole conduit entrance sizes and locations permits maximum flexibility of use in conduit system.
- Internal equipment mounting pads available blind tapped for 1/4" – 20 mounting screws.
- Blind tapped into internal mounting pads.
- Mounting straps are standard on all boxes.

Standard Materials:

- *Feraloy*® iron alloy cover and body
- Neoprene gaskets
- Stainless steel cover screws
- Steel mounting straps

Standard Finishes:

- *Feraloy* iron alloy – hot dip galvanized

Options:

- Factory installed mounting plate... add suffix -MP.
- See Ordering Information, beginning pg. 316, for:
 - Drilled and tapped conduit holes
 - Slip holes

Size Ranges:

- 4" x 4" x 2" to 24" x 24" x 8"

Certifications and Compliances:

- UL Standard: 50
- Dust-tight
- Weatherproof
- Raintight
- Watertight

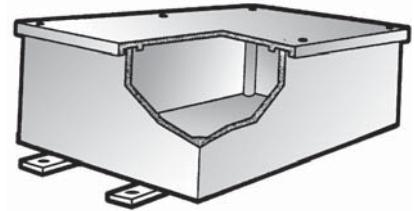

Ordering Information

Cat. #	Wall Thickness (in.)	Length (in.)	Width (in.)	Depth (in.)	Lightning Service
WCB040402	5/32	4	4	2	
WCB040403	3/16	4	4	3	✓
WCB040404	1/4	4	4	4	✓
WCB050503	1/4	5	5	3	✓
WCB050504	1/4	5	5	4	✓
WCB060403	1/4	6	4	3	✓
WCB060404	7/32	6	4	4	✓
WCB060603	1/4	6	6	3	✓
WCB060604	3/16	6	6	4	✓
WCB060606	9/32	6	6	6	✓
WCB080403	5/16	8	4	3	✓
WCB080604	7/32	8	6	4	✓
WCB080606	5/16	8	6	6	✓
WCB080804	5/16	8	8	4	✓
WCB080806	5/16	8	8	6	✓
WCB080808	5/16	8	8	8	✓
WCB090604	5/16	9	6	4	✓
WCB100604	1/4	10	6	4	✓
WCB100804	1/4	10	8	4	✓
WCB100806	9/32	10	8	6	✓
WCB101006	1/4	10	10	6	✓
WCB120604	9/32	12	6	4	✓
WCB120606	9/32	12	6	6	✓
WCB120806	9/32	12	8	6	✓
WCB120808	3/8	12	8	8	✓
WCB121204	9/32	12	12	4	✓
WCB121206	9/32	12	12	6	✓
WCB121208	9/32	12	12	8	✓
WCB160606	1/4	16	6	6	✓
WCB161208	5/16	16	12	8	✓
WCB181206	5/16	18	12	6	✓
WCB181208	5/16	18	12	8	✓
WCB181210	3/8	18	12	10	✓
WCB181806	3/8	18	18	6	✓
WCB181812	7/16	18	18	12	✓
WCB241212	7/16	24	12	12	✓
WCB242408	11/32	24	24	8	✓

✓ – available with Lightning Service™

WJB Junction Boxes

Heavy Duty

Flanged for Surface Mounting

See ordering info. on following pages
See dimensions on following pages

Weatherproof
Watertight
Raintight



Application:

WJB boxes are standard with mounting straps and are primarily designed for surface mounting. WJB heavy duty junction boxes are installed in conduit systems to:

- act as pull box for conductors
- provide openings and space for making splices and taps in conductors
- provide for branch conduit runs
- provide access to conductors for maintenance and future system changes
- enclose and protect electrical equipment

Features:

- Neoprene gasket cemented to cover.
- Wide range of drilled and tapped conduit entrance sizes and locations permits extreme flexibility of use in conduit system.
- Internal equipment mounting pads may be drilled and tapped for 1/4" – 20 mounting screws.
- Blind tapped into internal mounting pads.

Standard Materials:

- *Feraloy*® iron alloy body
- Heavy-gauge steel – cover and mounting straps
- Neoprene gaskets

Standard Finishes:

- *Feraloy* iron alloy and heavy-gauge steel – hot-dip galvanized

Options:

- Factory installed mounting plate... add suffix -MP.
- See Ordering Information, beginning pg. 316 for:
 - Drilled and tapped conduit holes
 - Slip holes

Size Ranges:

- 4" x 4" x 3" to 36" x 24" x 24"

Certifications and Compliances:

- UL Standard: 50
- CSA Standard C22.2
- Weatherproof
- Watertight
- CEC: Class II, E, F, G Class III
Encl. 3-4
- H20 Vehicle Load Rating *

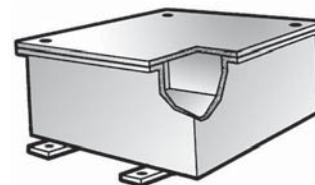

Ordering Information

Cat. #	Wall Thickness (in.)	Length (in.)	Width (in.)	Depth (in.)	Lightning Service
WJB040403	1/4	4	4	3	
WJB040404	1/4	4	4	4	✓
WJB060404	1/4	6	4	4	
WJB060604	1/4	6	6	4	✓
WJB060606	1/4	6	6	6	✓
WJB080604	1/4	8	6	4	
WJB080606	1/4	8	6	6	✓
WJB080804	1/4	8	8	4	✓
WJB080806	1/4	8	8	6	
WJB080808	1/4	8	8	8	
WJB100806	1/4	10	8	6	
WJB100808	1/4	10	8	8	
WJB101006	1/4	10	10	6	✓
WJB101008	1/4	10	10	8	
WJB120606	1/4	12	6	6	
WJB120806	1/4	12	8	6	
WJB120808	1/4	12	8	8	
WJB120810	1/4	12	8	10	
WJB121206	5/16	12	12	6	✓
WJB121208	5/16	12	12	8	✓
WJB121212	5/16	12	12	12	
WJB121218	5/16	12	12	18	
WJB140806	5/16	14	8	6	
WJB141410	5/16	14	14	10	
WJB161206	5/16	16	12	6	
WJB161208	5/16	16	12	8	
WJB161606	5/16	16	16	6	
WJB180806	5/16	18	8	6	
WJB180808	5/16	18	8	8	
WJB181006	5/16	18	10	6	
WJB181206	5/16	18	12	6	
WJB181208	5/16	18	12	8	✓
WJB181210	5/16	18	12	10	
WJB181212	5/16	18	12	12	
WJB181218	3/8	18	12	18	
WJB181806	3/8	18	18	6	
WJB181808	3/8	18	18	8	
WJB181812	3/8	18	18	12	
WJB181818	3/8	18	18	18	
WJB241208	3/8	24	12	8	
WJB241212	3/8	24	12	12	
WJB241808	3/8	24	18	8	
WJB241810	3/8	24	18	10	
WJB241812	3/8	24	18	12	
WJB241818	9/16	24	18	18	
WJB242412	9/16	24	24	12	
WJB242418	9/16	24	24	18	
WJB242424	9/16	24	24	24	
WJB302412	9/16	30	24	12	
WJB302418	9/16	30	24	18	
WJB362418	9/16	36	24	18	
WJB362424	9/16	36	24	24	

* Self certify to H20 vehicle load rating equivalent to 16,000 lbs. on cover center.
✓ – available with Lightning Service™

WJBF Checkered Cover Sidewalk Junction Boxes

**Heavy Duty
External Flanged for Flush Mounting**



See ordering info. on following pages
See dimensions on following pages
Weatherproof
Watertight
Raintight
NEMA 3,4

Application:

WJBF boxes are standard with mounting feet and have a recessed flat checkered sidewalk cover for mounting in walls or floors. They may be ordered less mounting feet. WJBF heavy duty junction boxes are installed in conduit systems to:

- act as pull box for conductors
- provide openings and space for making splices and taps in conductors
- provide for branch conduit runs
- provide access to conductor for maintenance and future system changes
- enclose and protect electrical equipment

Features:

- Covers are suitable for vehicular traffic (H20 loading)
- Neoprene gasket cemented to cover
- Wide range of drilled and tapped conduit entrance sizes and locations permits extreme flexibility of use in conduit system
- Internal equipment mounting pads may be drilled and tapped for 1/4" – 20 mounting screws
- Blind tapped into internal mounting pads

Standard Materials:

- Feraloy® iron alloy – body
- Heavy-gauge steel (checkered) – cover, mounting straps
- Neoprene gaskets

Standard Finishes:

- Feraloy iron alloy and heavy-gauge steel – hot dip galvanized

Options:

- Factory installed mounting plate... add suffix -MP.
- See Ordering Information, beginning pg. 316, for:
 - Drilled and tapped conduit holes
 - Slip holes

Size Ranges:

- 4" x 4" x 4" to 36" x 24" x 24"

Certifications and Complies:

- UL Standard: 50
- CSA Standard C22.2 No. 40
- Weatherproof
- Watertight
- CEC:
 - Class II, Division 1, Groups E,F,G
 - Class III
 - Encl. 3, 4
- H20 Vehicle Load Rating *

✓ – available with Lightning Service™

* Self certify to H20 vehicle load rating equivalent to 16,000 lbs. on cover center.

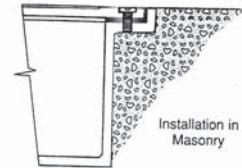
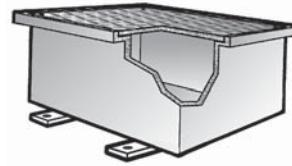

Ordering Information

Cat. #	Wall Thickness (in.)	Length (in.)	Width (in.)	Depth (in.)	Lightning Service
WJBF040404	1/4	4	4	4	✓
WJBF060404	1/4	6	4	4	✓
WJBF060604	1/4	6	6	4	✓
WJBF060606	1/4	6	6	6	✓
WJBF080604	1/4	8	6	4	✓
WJBF080606	1/4	8	6	6	✓
WJBF080804	1/4	8	8	4	✓
WJBF080806	1/4	8	8	6	✓
WJBF080808	1/4	8	8	8	✓
WJBF100806	1/4	10	8	6	
WJBF100808	1/4	10	8	8	
WJBF101006	1/4	10	10	6	✓
WJBF101008	1/4	10	10	8	✓
WJBF120606	1/4	12	6	6	
WJBF120806	1/4	12	8	6	
WJBF120808	1/4	12	8	8	✓
WJBF120810	5/16	12	8	10	
WJBF121206	1/4	12	12	6	✓
WJBF121208	1/4	12	12	8	✓
WJBF121212	5/16	12	12	12	✓
WJBF121218	5/16	12	12	18	
WJBF140806	1/4	14	8	6	
WJBF141410	5/16	14	14	10	
WJBF161206	1/4	16	12	6	
WJBF161208	1/4	16	12	8	✓
WJBF161606	1/4	16	16	6	
WJBF180806	1/4	18	8	6	
WJBF180808	1/4	18	8	8	
WJBF181006	5/16	18	10	6	
WJBF181206	5/16	18	12	6	
WJBF181208	5/16	18	12	8	✓
WJBF181210	3/8	18	12	10	
WJBF181212	5/16	18	12	12	
WJBF181218	3/8	18	12	18	
WJBF181806	3/8	18	18	6	
WJBF181808	3/8	18	18	8	
WJBF181812	3/8	18	18	12	✓
WJBF181818	3/8	18	18	18	
WJBF241208	3/8	24	12	8	
WJBF241212	3/8	24	12	12	
WJBF241808	3/8	24	18	8	
WJBF241810	3/8	24	18	10	✓
WJBF241812	3/8	24	18	12	
WJBF241818	3/8	24	18	18	
WJBF242412	3/8	24	24	12	
WJBF242418	3/8	24	24	18	
WJBF242424	3/8	24	24	24	
WJBF302412	3/8	30	24	12	
WJBF302418	3/8	30	24	18	
WJBF362418	3/8	36	24	18	
WJBF362424	3/8	36	24	24	

WEB Junction Box

Heavy Duty Internal Recess Flange for Flush Mounting

Dust-tight
Raintight
NEMA 3

Application:

WEB Junction Boxes are installed:

- Where a heavy duty, dust-tight or raintight enclosure is desired
- To act as pull box for conductors
- To provide openings and space for making splices and taps in conductors
- To provide for branch conduit runs
- To provide access to conductors for maintenance and future system changes
- To enclose and protect electrical devices

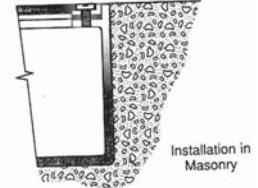
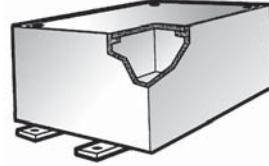

Features:

- Flat neoprene gasket cemented to cover
- Internal equipment mounting pads
- Standard attachable heavy-gauge steel straps for mounting box
- Stainless-steel cover screws
- Internal ground screw
- Optional drilled and tapped conduit entries or slip holes
- Optional mounting plate

Standard Materials:

- Body-*Feraloy*[®] iron alloy, hot dip galvanized
- Cover – heavy-gauge steel, hotdip galvanized
- Cover screws – stainless steel
- Mounting Strap – heavy-gauge steel, electrogalvanized
- Gasket – neoprene

Certifications and Compliances:

- UL Standard 50
- CSA certified C22.2

Options:

- All boxes are available with optional mounting plate, add suffix -MP.
See ordering information beginning on pg. 316 for:
- Drilled and tapped conduit holes
 - Slip holes

Ordering Information

Cat. #	Wall Thickness (in.)	Length (in.)	Width (in.)	Depth (in.)
WEB040403	7/32	4	4	3
WEB040404	1/4	4	4	4
WEB060604	9/32	6	6	
WEB060606	1/4	6	6	6
WEB080804	9/32	8	8	4
WEB080806	1/4	8	8	6
WEB121206	9/32	12	12	6
WEB160606	9/32	16	6	6
WEB160806	1/4	16	8	6
WEB180808	5/16	18	8	8
WEB240606	9/32	24	6	6
WEB240808	5/16	24	8	8
WEB241010	3/8	24	10	10
WEB241210	5/16	24	12	10
WEB241212	5/16	24	12	12
WEB241812	3/8	24	18	12
WEB361212	3/8	36	12	12
WEB361812	3/8	36	18	12
WEB362412	7/16	36	24	12
WEB363612	7/16	36	36	12

W Series Junction Boxes

Ordering Information

DRILLED AND TAPPED CONDUIT OPENINGS OR SLIP HOLES

All W-Series cast-iron junction boxes may be ordered with drilled and tapped conduit openings or slip holes – subject to minimum spacing limitations listed in Table 1.

To order a box from the factory with conduit openings:

Options 1:

Send in a sketch of the box with openings specified (subject to spacing limitations specified in Table 1). **OR**

Option 2:

Step 1: Select one of the four standard arrangements in Table 2, based on number and location of conduit entries.
 Step 2: Pick a symbol from Table 3 for each opening in the arrangement (see example).
 Step 3: Table 4 lists the maximum size and number of conduit openings by box size and the spacing dimensions. Use Table 4 to verify the openings selected are permitted.

Example – Catalog number logic:

- Select box required: WAB121208.
- User wants one 1/2" drilled and tapped hole in the top of the box, two 1" drilled and tapped holes on both sides and three 1/2" slip holes in the bottom of the box.
- Select arrangement 3 because it allows up to three openings per side.
- Next the symbols for the openings are substituted and written in clockwise order starting with location "a". The catalog number is written in three parts; part 1 – box number, part 2 – arrangement number, part 3 – symbols for the conduit openings.
- For this example the box would be ordered as:

WAB121208-3-0AO C0C 1A1A1A C0C

Box	Arrangement #	Symbols
Cat. #		for openings

Table 1
Minimum spacing between centers of conduits

Size of Conduit	6"	5"	4"	3 1/2"	3"	2 1/2"	2"	1 1/2"	1 1/4"	1"	3/4"	1/2"
1/2"	5	4 3/8	3 5/8	3 3/8	3	2 5/8	2 3/8	2	1 7/8	1 3/4	1 5/8	1 1/2
3/4"	5 1/8	4 1/2	3 3/4	3 1/2	3 1/8	2 3/4	2 1/2	2 1/8	2	1 7/8	1 3/4	
1"	5 1/4	4 5/8	4	3 5/8	3 1/4	3	2 5/8	2 3/8	2 1/4	2		
1 1/4"	5 1/2	4 7/8	4 1/8	3 7/8	3 1/2	3 1/8	2 7/8	2 1/2	2 3/8			
1 1/2"	5 5/8	5	4 1/4	4	3 5/8	3 1/4	3	2 5/8				
2"	6	5 3/8	4 5/8	4 1/4	3 7/8	3 5/8	3 1/4					
2 1/2"	6 1/4	5 5/8	4 7/8	4 5/8	4 1/4	3 7/8						
3"	6 5/8	6	5 3/8	5	4 5/8							
3 1/2"	7	6 1/4	5 5/8	5 1/4								
4"	7 1/4	6 5/8	5 7/8									
5"	8	7 1/4										
6"	8 5/8											

Table 2
Standard conduit arrangements

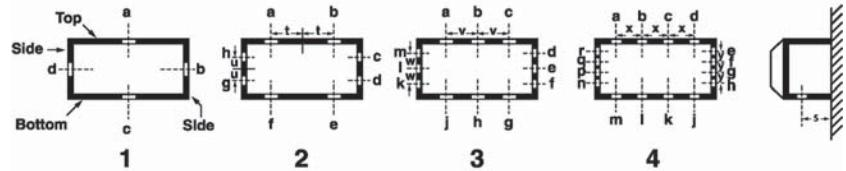

Table 3
Symbols for openings

Conduit Size	Drilled and Tapped Hole	Slip Hole
1/2"	A	1A
3/4"	B	1B
1"	C	1C
1 1/4"	E	1E
1 1/2"	F	1F
2"	G	1G
2 1/2"	H	1H
3"	J	1J
3 1/2"	K	1K
4"	L	1L
5"	M	1M
6"	N	1N
None	0 (Zero)	0 (Zero)



S = Dimension from wall to hole center line

W Series Junction Boxes

Ordering Information

Table 4

W Series Cat. #	Maximum Size and Number of Drilled and Tapped Conduit Openings Top and Bottom†				Sides				Spacing Dimensionst							
	1	2	3	4	1	2	3	4	s	t	u	v	w	x	y	
	040402	¾	¾	—	—	¾	¾	—	—	1¼	7/8	7/8	—	—	—	—
040403	1¼	¾	—	—	1¼	¾	—	—	1½	7/8	7/8	—	—	—	—	
040404	2	¾	—	—	2	¾	—	—	2¼	7/8	7/8	—	—	—	—	
050503	1¼	¾	—	—	1¼	¾	—	—	1½	1¼	1¼	—	—	—	—	
050504	2	1	—	—	2	1	—	—	2¼	1¼	1¼	—	—	—	—	
060403	1¼	¾	¾	—	1¼	¾	—	—	1½	1¾	7/8	1¾	—	—	—	
060404	2	1½	¾	—	2	¾	—	—	2¼	1¾	7/8	1¾	—	—	—	
060603	1¼	1¼	¾	—	1¼	1¼	¾	—	1¼	1¾	1¾	1¾	1¾	—	—	
060604	2	1½	¾	—	2	1½	¾	—	2¼	1¾	1¾	1¾	1¾	—	—	
060606	4	1½	¾	—	4	1½	¾	—	3¾	1¾	1¾	1¾	1¾	—	—	
080403	1¼	1¼	1	¾	1¼	¾	—	—	1½	1½	7/8	2½	—	—	—	
080604	2	2	1	¾	2	1½	¾	—	2¼	1½	1¾	2½	1¾	1¾	—	
080606	4	2	1	¾	4	1½	¾	—	3¾	1½	1¾	2½	1¾	1¾	—	
080804	2	2	1	¾	3	2	1	¾	2¼	1½	1½	2½	2½	1¾	1¾	
080806	4	2	1	¾	4	2	1	¾	3¾	1½	1½	2½	2½	1¾	1¾	
080808	4	2	1	¾	4	2	1	¾	4¼	1½	1½	2½	2½	1¾	1¾	
090604	2	1¼	1½	1	2	1½	¾	—	2¼	2¼	1¾	3	1¾	2	—	
100604	2	2	1½	1	2	1½	¾	—	2¼	2½	1¾	2¾	1¾	2½	—	
100804	2	2	1½	1	2	2	1	¾	2¼	2½	1½	2¾	2½	2½	1¾	
100806	4	3	1½	1	4	2	1	¾	3¾	2½	1½	2¾	1¾	2½	1¾	
100808	5	3	1½	1	5	2	1	¾	4½	2½	1½	2¾	2½	2½	1¾	
101006	4	3	1½	1	3	3	1½	1	2¾	2½	2½	2¾	2¾	2½	2½	
101008	5	3	1½	1	5	3	1½	1	4¼	2½	2½	2¾	2¾	2½	2½	
120604	2	2	2	1½	2	1½	¾	—	2¼	3	1¾	4	1¾	2¾	—	
120606	4	4	2½	1½	4	1½	¾	—	3¾	3	1¾	4	1¾	2¾	—	
120806	4	4	2½	2½	4	2	1	¾	3¾	3	1½	4	2½	2¾	1¾	
120808	5	4	2½	2½	5	2	1	¾	4¼	3	1½	4	2½	2¾	1¼	
121204	2	2	2	1½	2	2	2	1½	2¼	3	3	4	4	2¾	2¾	
121206	4	4	2½	1½	4	4	2½	1½	3¾	3	3	4	4	2¾	2¾	
121208	5	4	2½	1½	5	4	2½	1½	4¼	3	3	4	4	2¾	2¾	
121212	6	4	2½	1½	6	4	2½	1½	5	3	3	4	4	2¾	2¾	
121218	6	4	2½	1½	6	4	2½	1½	5	3	3	4	4	2¾	2¾	
140806	4	4	3	2	4	2	1	¾	3¾	3½	1½	4½	2½	3½	1¾	
141206	4	4	3	2	4	4	2½	1½	3¾	3½	3	4½	4	3½	2¾	
141410	6	4	3	2	6	4	3	2	5	3½	3½	4½	4½	3½	3½	
160606	4	4	3½	2½	4	1½	¾	—	3¾	4	1½	5¾	2	4	—	
160806	4	4	3½	2½	4	2½	1½	¾	3¾	4	2	5¾	2½	4	2	
161206	4	4	3½	2½	4	4	2½	1½	3¾	4	3	5¾	4	4	3	
161208	5	5	3½	2½	5	4	2½	1½	4¼	4	3	5¾	4	4	3	
161606	4	4	3½	2½	4	4	3½	2½	3¾	4	4	5¾	5¾	4	4	
180806	4	4	4	2½	4	2½	1¼	¾	3¾	4½	2	6	2½	4½	2	
180808	5	5	4	2½	5	2½	1¼	¾	4¼	4½	2	6	2½	4½	2	
181206	4	4	4	2½	4	4	2½	1½	3¾	6½	2½	5½	3¾	4	2¾	
181208	5	5	4	2½	5	4	2½	1½	4¼	4½	3	5½	4	4	2¾	
181210	6	5	4	2½	6	4	2½	1½	5	4¼	3	5½	4	4	2¾	

†Spacing dimensions apply to drilled and tapped holes. Space has been provided for a locknut and bushing when drilled and tapped holes are required.
‡Top and bottom are the longer dimensions on enclosures which are not square.

W Series Junction Boxes

Ordering Information

Table 4 (continued)

W Series Cat. #	Maximum Size and Number of Drilled and Tapped Conduit Openings				Spacing Dimensions†											
	Top and Bottom‡				Sides				s	t	u	v	w	x	y	
	1	2	3	4	1	2	3	4								
181212	6	5	4	2½	6	4	2½	1½	5	4½	3	5½	4	4	2¼	
181218	6	5	4	2½	6	4	2½	1½	5	4½	3	5½	4	4	2¾	
181806	4	4	4	2½	5	5	4	2½	3¾	4½	4	6	5¾	4½	4	
181808	5	5	4	2½	5	5	3½	2½	4¼	4½	4	6	5¾	4½	4	
181812	6	6	4	2½	6	6	4	2½	5	4½	4½	6	6	4½	4½	
240606	4	4	4	4	4	1½	¾	—	3¾	6¾	1¾	8	1¾	6	—	
240808	5	5	5	4	5	2½	1¼	¾	4¼	6¾	4½	8	2¾	6	2	
241010	6	6	5	4	6	3	1½	1	5	6½	2½	7	2¾	5¾	2½	
241208	5	5	5	4	5	4	2½	1½	4¼	6½	2¾	7	3¾	5¾	2¾	
241210	6	6	5	4	6	4	2½	1½	5	6½	3	7	4	5¾	2¾	
241212	6	6	5	4	6	4	2½	1½	5	6½	2¾	7	3¾	5¾	2¾	
241808	5	5	5	4	5	5	4	2½	4¼	6½	4½	7	5¾	5¾	4	
241810	6	6	5	4	6	6	4	2½	5	6½	4½	7	5¾	5¾	4	
241812	6	6	5	4	6	5	4	2½	5	6½	4½	7	5¾	5¾	4	
242408	5	5	5	4	5	5	5	4	4¼	6½	6½	7	7½	5¾	5¾	
242412	6	6	5	4	6	6	5	4	5	6½	6½	7	7½	5¾	5¾	
242424	6	6	5	4	6	6	5	4	6½	6¾	6½	7	7½	5¾	5¾	
302412	6	6	6	5	6	6	5	4	5	7½	6¾	10	8	7½	6	
361212	6	6	6	6	6	4	2½	1½	5	8¾	3	12	4	9	2¾	
361812	6	6	6	6	6	5	4	2½	5	8¾	4½	12	4½	9	4	
362412	6	6	6	6	6	6	5	4	5	8¾	6¾	12	8	9	6	
363612	6	6	6	6	6	6	6	6	5	8¾	8¾	12	12	9	9	

†Spacing dimensions apply to drilled and tapped holes. Space has been provided for a locknut and bushing when drilled and tapped holes are required.
‡Top and bottom are the longer dimensions on enclosures which are not square.

XD Expansion/Deflection Coupling

Watertight
Corrosion-Resistant

Application:

XD couplings can be installed indoors, outdoors, buried underground, or embedded in concrete in non-hazardous areas. XD's are used with standard rigid conduit or PVC rigid conduit. (PVC requires rigid metal conduit nipples and rigid metal-to-PVC conduit adapters.) XD's provide a flexible and watertight connection for protection of conduit wiring systems from damage due to movement.

Typical applications include:

- Underground conduit feeder runs
- Runs between sections of concrete subject to relative movement
- Runs between fixed structures
- Conduit entrances in high-rise buildings
- Bridges
- Marinas, docks, piers

Features:

- XD couplings accommodate the following movements without collapsing or fracturing the conduit, and damaging the wires it contains:
 1. Axial expansion or contraction up to $\frac{3}{4}$ "
 2. Angular misalignment of the axes of the coupled conduit runs in any direction to 30°
 3. Parallel misalignment of the axes of coupled conduit runs in any direction to $\frac{3}{4}$ "
- Inner sleeve maintains constant I.D. in any position and provides a smooth insulated wireway for protection of wire insulation
- Watertight flexible neoprene outer jacket is corrosion resistant and protects the grounding strap and the attachment points of the hubs
- Tinned copper flexible braid grounding straps assure grounding continuity
- Stainless steel jacket clamps for strength and corrosion resistance
- Standard tapered electrical threads fit standard rigid conduit
- Integral hub bushing protects insulation of conductors

Standard Materials:

- Hubs – *Feraloy*[®] iron alloy
- Outer jacket – molded neoprene
- Jacket clamps – stainless steel
- Inner sleeve – molded plastic
- Grounding straps – tinned copper flexible braid

Standard Finishes:

- *Feraloy* – electrogalvanized
- Neoprene – natural (black)
- Molded plastic – natural (brown)

Certifications and Complies:

- UL standards: 514B

Size Ranges:

- 1" to 6" (Smaller sizes can be obtained by using reducing bushings)

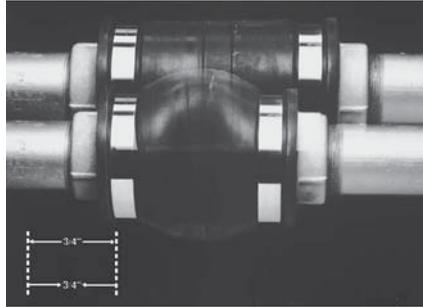

1. Axial expansion/contraction.

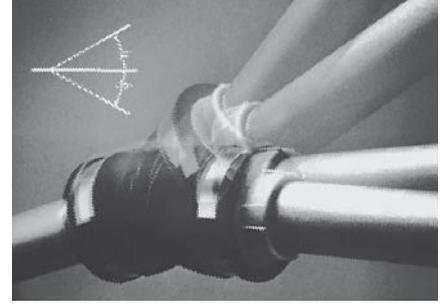

2. Angular misalignment.

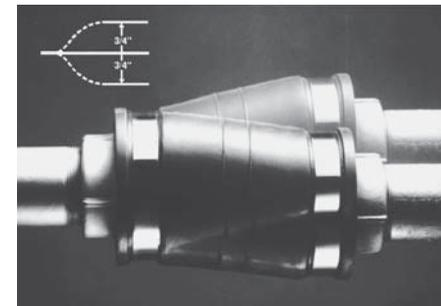

3. Parallel misalignment.

XD

Ordering Information

Hub Size	Cat. #	Hub Size	Cat. #
1	XD3	3	XD8
1 1/4	XD4	3 1/2	XD9
1 1/2	XD5	4	XD010
2	XD6	5	XD012
2 1/2	XD7	6	XD014

Dimensions

Hub Size	a	b
1	7	3 15/16
1 1/4	7 3/8	4 1/4
1 1/2	7 1/4	4 1/2
2	7 1/4	4 15/16
2 1/2	7 1/2	5 5/16
3	7 3/8	5 15/16
3 1/2	7 3/4	6 1/2
4	7 7/8	6 15/16
5	7 3/4	8
6	8 3/8	9

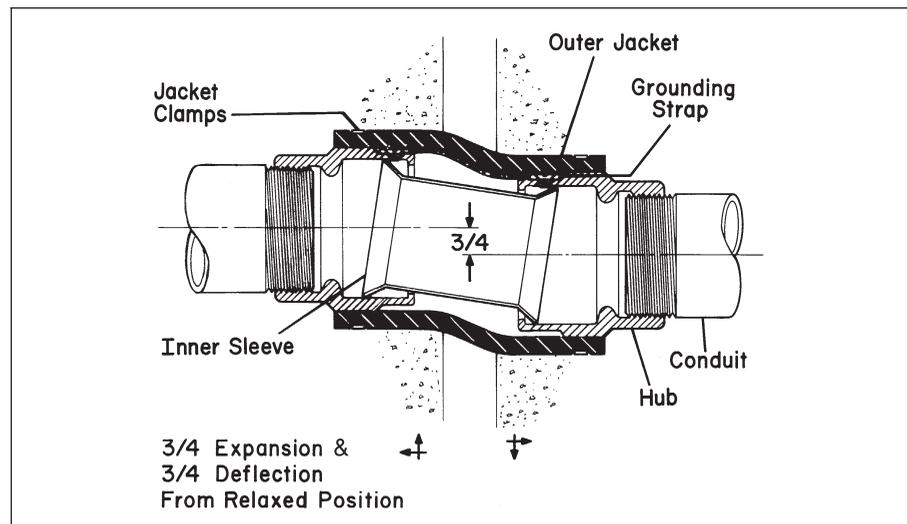
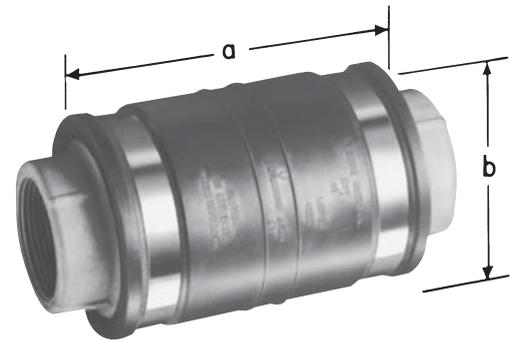

XJG Conduit Expansion Joints With Internal Grounding For Rigid Metal Conduit and IMC

Wet Locations

Application:

XJG expansion couplings are used with rigid metal conduit and IMC:

- **without** the need for an external bonding jumper and clamps (up to 4")
- to couple together two (2) sections of conduit subject to longitudinal movement
- in long conduit runs to permit linear movement caused by thermal expansion and contraction.
- on long conduit runs to prevent conduit from buckling and ensuing circuit failures
- indoors or outdoors where conduit expansion occurs and there are wide temperature ranges
- in conduit runs that cross structural joints
- in conduit runs to prevent damage to conduit supports such as in a building or on a bridge
- **with optional redundant visible grounding strap**

Standard Materials and Finishes

Body

- Steel-electrogalvanized
- Copper-free aluminum - natural
- Feraloy® iron alloy - electrogalvanized (5" + 6" only)

Reducer

- ½" through 1" - Steel - electrogalvanized
- 1¼" through 6" - Feraloy® iron alloy - electrogalvanized and aluminum paint
- Copper-free aluminum - natural

Gland Nut

- ½" through 1" - Steel - electrogalvanized
- 1¼" through 6" - Feraloy® iron alloy - electrogalvanized and aluminum paint
- Copper-free aluminum - natural

Packing

- Teflon® (trademark of E.I. DuPont Co.)

Washer

- Steel - electrogalvanized
- Copper-free aluminum - natural

Gasket

- Vellum

Bushing

- ½" through 1" - Steel - electrogalvanized
- 1¼" through 6" - Feraloy® iron alloy - electrogalvanized and aluminum paint
- Copper-free aluminum - natural

Ground Springs

- Phosphor bronze - electrogalvanized

Ground Strap

- Braided tinned copper

U-Bolts

- Malleable iron – electrogalvanized

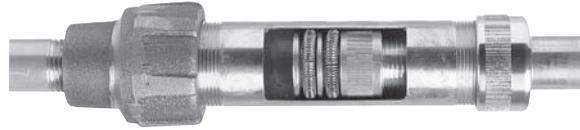

Patent Pending*

XJG – For use with rigid metal conduit and IMC

Conduit Size	Maximum Conduit Movement	Catalog Number	Optional Bonding Jumper	A Diameter	B Length	Bonding Jumper Length
½	4	XJG14	BJ14	1.75	6.75	20"
	8	XJG18	BJ18	1.75	10.75	30"
¾	4	XJG24	BJ24	2.12	6.75	20"
	8	XJG28	BJ28	2.12	10.75	30"
1	4	XJG34	BJ34	2.43	7.25	20"
	8	XJG38	BJ38	2.43	11.25	30"
1¼	4	XJG44	BJ44	3.19	7.56	24"
	8	XJG48	BJ48	3.19	11.56	30"
1½	4	XJG54	BJ54	3.68	7.87	24"
	8	XJG58	BJ58	3.68	11.87	30"
2	4	XJG64	BJ64	4.75	8.25	24"
	8	XJG68	BJ68	4.75	12.25	30"
2½	4	XJG74	BJ74	4.87	9.31	24"
	8	XJG78	BJ78	4.87	13.31	36"
3	4	XJG84	BJ84	5.37	10.00	30"
	8	XJG88	BJ88	5.37	14.00	36"
3½	4	XJG94	BJ94	6.62	9.81	30"
	8	XJG98	BJ98	6.62	13.81	36"
4	4	XJG104	BJ104	6.62	9.81	30"
	8	XJG108	BJ108	6.62	13.81	36"
5	8	XJ128†	—	7.64	15.50	—
6	8	XJ148†	—	9.56	16.00	—

Options:

Available in copper-free aluminum – add suffix SA to Cat. No.

Available with redundant† ground strap for visible indication of grounding – order separately (BJ Series)

Size Ranges:

- ½" through 6" conduit size
- 4" and 8" maximum conduit movement

Certifications and Compliances:

- UL Standard: 514B
- CSA Standard: C22.2 No. 18
- NEC Articles 250-77 and 300-7 (b)
- NEMA FB1
- Wet Locations

Dimensions

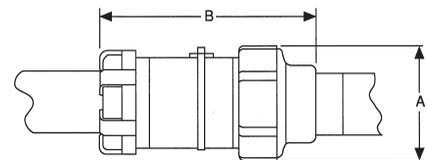

XJG shown with optional bonding jumper

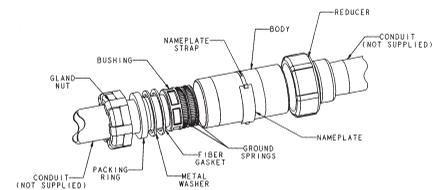

* Teflon® is a registered trademark of E.I. DuPont Co.

† XJG expansion couplings use a metallic bushing and ground springs to create a high integrity internal ground connection. External ground straps offer a redundant ground path and easy visible indication of ground

XJG-EMT Conduit Expansion Joints With Internal Grounding For EMT Conduit

Application:

XJG expansion couplings are used with EMT Conduit:

- without the need for an external bonding jumper and clamps
- to couple together two (2) sections of conduit subject to longitudinal movement
- in long conduit runs to permit linear movement caused by thermal expansion and contraction.
- on long conduit runs to prevent conduit from buckling and ensuing circuit failures
- indoors or outdoors where conduit expansion occurs and there are wide temperature ranges
- in conduit runs that cross structural joints
- in conduit runs to prevent damage to conduit supports such as in a building or on a bridge
- with optional redundant visible grounding strap

Standard Materials and Finishes

Body

- Steel-electrogalvanized
- Copper-free aluminum - natural

Reducer

- 1/2" through 1" - Steel - electrogalvanized
- 1 1/4" through 4" - *Feraloy*® iron alloy - electrogalvanized and aluminum paint

Gland Nut

- 1/2" through 1" - Steel - electrogalvanized
- 1 1/4" through 4" - *Feraloy*® iron alloy - electrogalvanized and aluminum paint

Packing

- Teflon® (trademark of E.I. DuPont Co.)

Washer

- Steel - electrogalvanized

Gasket

- Vellum

Bushing

- 1/2" through 1" - Steel - electrogalvanized
- 1 1/4" through 4" - *Feraloy*® iron alloy - electrogalvanized and aluminum paint

Ground Springs

- Phosphor bronze - electrogalvanized

Ground Strap

- Braided tinned copper

U-Bolts

- Malleable iron – electrogalvanized

Options:

Available with redundant† ground strap for visible indication of grounding – order separately (BJ Series)

Size Ranges:

- 1/2" through 4" conduit size
- 4" maximum conduit movement

Certifications and

Compliances:

- UL Standard: 514B
- CSA Standard: C22.2 No. 18
- NEC Articles 250-77 and 300-7 (b)
- NEMA FB1



XJG-EMT – for use with EMT conduit

Conduit Size	Maximum Conduit Movement	Catalog Number	Optional Bonding Jumper	A Diameter	B Length
1/2"	4"	XJG14-EMT	BJ14	1 3/4"	10 3/4"
3/4"	4"	XJG24-EMT	BJ24	2 1/8"	11"
1"	4"	XJG34-EMT	BJ34	2 7/16"	11 1/2"
1 1/4"	4"	XJG44-EMT	BJ44	3 1/8"	15 1/4"
1 1/2"	4"	XJG54-EMT	BJ54	3 5/8"	15 1/2"
2"	4"	XJG64-EMT	BJ64	4 3/4"	15 1/2"
2 1/2"	4"	XJG74-EMT	BJ74	4 7/8"	18 3/4"
3"	4"	XJG84-EMT	BJ84	5 3/8"	19 7/8"
3 1/2"	4"	XJG94-EMT	BJ94	6 5/8"	21 1/4"
4"	4"	XJG104-EMT	BJ104	6 5/8"	21 1/4"



XJG shown with optional bonding jumper

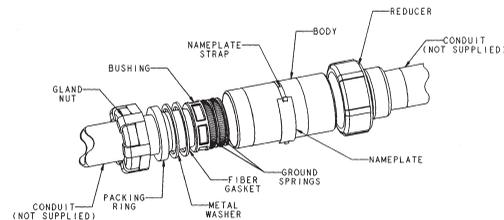

* Teflon® is a registered trademark of E.I. DuPont Co.

† XJG expansion couplings use a metallic bushing and ground springs to create a high integrity internal ground connection. External ground straps offer a redundant ground path and easy visible indication of ground

XJGD Combination Expansion/Deflection Coupling and Expansion Joint Internally Grounded

Wet Locations

Application:

XJGD combination fittings are used with rigid metal conduit and IMC:

- to accommodate axial expansion, angular misalignment and parallel misalignment
- to couple together two (2) sections of conduit subject to longitudinal movement
- to maintain a ground connection *without the need for an external bonding jumper and clamps*
- in long conduit runs to prevent conduit from buckling and causing circuit failures
- indoors or outdoors where conduit expansion occurs and there are wide temperature swings
- in conduit runs that cross structural joints
- in conduit runs to prevent damage to conduit supports such as in a building or on a bridge

Standard Materials:

- Body, Hubs, Gland Nut, Washer, Bushing – *Feraloy*[®]
- Packing – Teflon[®]
- Gasket – vellum
- Ground Spring – phosphor bronze
- Outer Jacket – molded neoprene
- Jacket Clamps – stainless steel
- Inner Sleeve – molded plastic
- Ground Straps – tinned copper braid

Standard Finishes:

- *Feraloy*[®] – electrogalvanized

Certifications and Compliances:

- UL standard: 514B



XJGD Ordering Information

Hub Size	Maximum Conduit Movement	Catalog Number	A Diameter	B Length
1"	4"	XJGD34	3 ¹⁵ / ₁₆ "	17 ³ / ₄ "
1 ¹ / ₄ "	4"	XJGD44	4 ¹ / ₄ "	18 ¹ / ₈ "
1 ¹ / ₂ "	4"	XJGD54	4 ¹ / ₂ "	18 ⁵ / ₈ "
2"	4"	XJGD64	4 ¹⁵ / ₁₆ "	19 ¹ / ₄ "
2 ¹ / ₂ "	4"	XJGD74	5 ⁵ / ₁₆ "	20 ³ / ₄ "
3"	4"	XJGD84	5 ¹⁵ / ₁₆ "	21 ⁵ / ₈ "
3 ¹ / ₂ "	4"	XJGD94	6 ¹ / ₂ "	21 ⁵ / ₈ "
4"	4"	XJGD104	8"	27 ³ / ₄ "

For more information:

Contact an authorized Cooper Crouse-Hinds Distributor, Sales Office or Customer Service Department:

Distributed by:

In the U.S.:

Cooper Crouse-Hinds
P.O. Box 4999
Syracuse, NY 13221
Toll Free: 866-764-5454
(315) 477-5531
FAX: (315) 477-5179
crouse.customerctr@crouse-hinds.com

In Canada:

Cooper Crouse-Hinds Canada
Toll Free: 800-265-0502
(905) 507-4187
FAX: (905) 568-7048

**For office locations outside of North America
or for additional product information, visit our
website at: www.crouse-hinds.com**

Mexico • Latin America/Caribbean • Germany • Australia • Asia • Dubai • India

COOPER Crouse-Hinds

4870-0406

Solutions. Worldwide.™

Crouse-Hinds is a registered trademark of Cooper Industries, Inc.
© 2006 Cooper Industries, Inc.



Printed in U.S.A

X-ON Electronics

Largest Supplier of Electrical and Electronic Components

Click to view similar products for [Crouse-Hinds](#) manufacturer:

Other Similar products are found below :

[RE21](#) [14W48](#) [E1016-1612S](#) [15W47](#) [EMP:0205057-J10](#) [NOR-000-002-220-232](#) [RPE417-116](#) [A100601-24](#) [LT20090](#) [AP100-CON-KIT](#)
[GHG-262-2301-L0003](#) [GLL1](#) [CGB5913](#) [CGB6920](#) [CGD196](#) [CGD197](#) [CGD292](#) [CGD297](#) [TMCX6206](#) [5000115-189B](#) [RPE421-121](#) [51F2F-](#)
[D0](#) [EFS2192](#) [CGE395](#) [CGD293](#) [CGB5915](#) [CGB4911](#) [CG5045 350](#) [CG10090 1050](#) [W2H840](#) [E1016-1600S](#) [NJBW050905TC](#)
[PVM25L2B/UNV1](#) [PVM11LR3B2/UNV1](#) [XJG84](#) [E1016-1687S](#) [CGD4911](#) [AP20458](#) [GH420P5W](#) [DEV12-S769](#) [UNY805](#) [EBM:0206695](#)
[CH360RA6W](#) [ZD13701](#) [EDS11273](#) [STBS1151509](#) [EMP049](#) [ATP375](#) [EFSC2190](#) [DSD918-S769-EM-SP](#)