

## LAY-IN PAINTED FLAT-COVER WIREWAY, NEMA TYPE 1



### APPLICATION

This painted wireway features an open design on one side so wires and cables can be laid in safely along the entire run without pulling, a practice that can damage insulation. A variety of lengths and fittings provide design flexibility.

### FEATURES

- Flat cover design
- Open top assembly
- Available with or without knockouts
- Keyhole screw slots on flat covers

### SPECIFICATIONS

- 16 and 14 gauge pre-painted steel covers and bodies

### FINISH

ANSI 61 gray polyester powder paint finish inside and out.

### INDUSTRY STANDARDS

UL 870 Listed; File No. E27524  
 cUL Listed per CSA C22.2 No. 26; File No. E27524

NEMA/EEMAC Type 1  
 IEC 60529

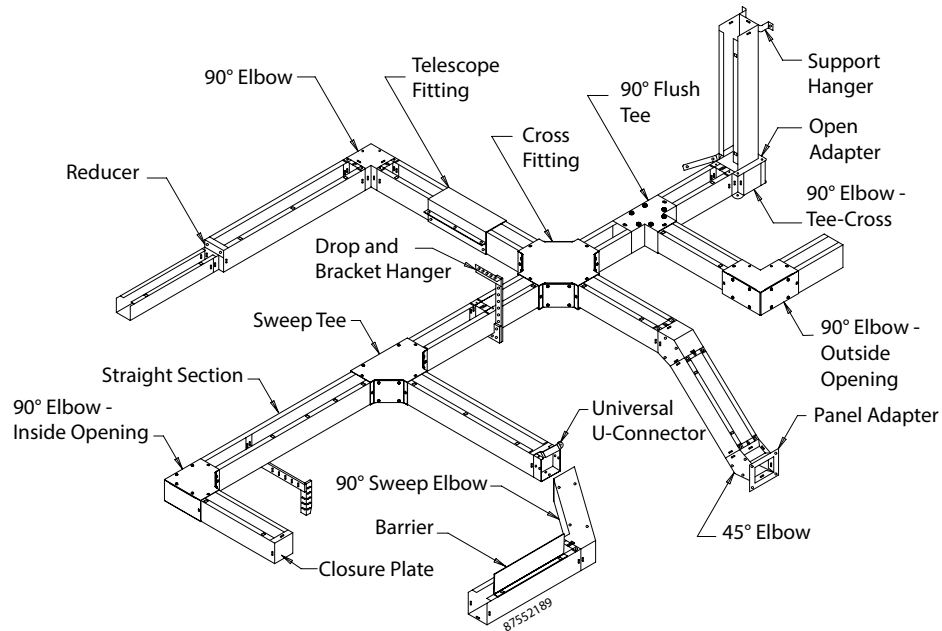

Standard Product Selection Matrix

| Description  | 2.50 x 2.50 in.<br>(64 x 64 mm) | 3.00 x 3.00 in.<br>(76 x 76 mm) | 4.00 x 4.00 in.<br>(102 x 102 mm) | 6.00 x 6.00 in.<br>(152 x 152 mm) | 8.00 x 8.00 in.<br>(203 x 203 mm) | 10.00 x 10.00 in.<br>(254 x 254 mm) | 12.00 x 12.00 in.<br>(305 x 305 mm) |
|--|---------------------------------|---------------------------------|-----------------------------------|-----------------------------------|-----------------------------------|-------------------------------------|-------------------------------------|
| 12.00-in. (305-mm) Straight Section with knockouts       | F22T112GVPWK                    | —                               | F44T112GVPWK                      | F66T112GVPWK                      | F88T112GVPWK                      | —                                   | F1212T112GVPWK                      |
| 12.00-in. (305-mm) Straight Section without knockouts    | F22T112GVP                      | —                               | F44T112GVP                        | F66T112GVP                        | F88T112GVP                        | F1010T112GVP                        | F1212T112GVP                        |
| 18.00-in. (455-mm) Straight Section without knockouts    | —                               | —                               | F44T118GVP                        | F66T118GVP                        | F88T118GVP                        | —                                   | —                                   |
| 24.00-in. (610-mm) Straight Section with knockouts       | F22T124GVPWK                    | —                               | F44T124GVPWK                      | F66T124GVPWK                      | F88T124GVPWK                      | —                                   | F1212T124GVPWK                      |
| 24.00-in. (610-mm) Straight Section without knockouts    | F22T124GVP                      | —                               | F44T124GVP                        | F66T124GVP                        | F88T124GVP                        | F1010T124GVP                        | F1212T124GVP                        |
| 36.00-in. (914-mm) Straight Section with knockouts       | F22T136GVPWK                    | —                               | F44T136GVPWK                      | F66T136GVPWK                      | F88T136GVPWK                      | —                                   | F1212T136GVPWK                      |
| 36.00-in. (914-mm) Straight Section without knockouts    | F22T136GVP                      | —                               | F44T136GVP                        | F66T136GVP                        | F88T136GVP                        | F1010T136GVP                        | F1212T136GVP                        |
| 48.00-in. (1219-mm) Straight Section with knockouts      | F22T148GVPWK                    | —                               | F44T148GVPWK                      | F66T148GVPWK                      | F88T148GVPWK                      | —                                   | F1212T148GVPWK                      |
| 48.00-in. (1219-mm) Straight Section without knockouts   | F22T148GVP                      | —                               | F44T148GVP                        | F66T148GVP                        | F88T148GVP                        | F1010T148GVP                        | F1212T148GVP                        |
| 60.00-in. (1524-mm) Straight Section with knockouts      | F22T160GVPWK                    | —                               | F44T160GVPWK                      | F66T160GVPWK                      | F88T160GVPWK                      | —                                   | F1212T160GVPWK                      |
| 60.00-in. (1524-mm) Straight Section without knockouts   | F22T160GVP                      | F33T160GVP                      | F44T160GVP                        | F66T160GVP                        | F88T160GVP                        | F1010T160GVP                        | F1212T160GVP                        |
| 72.00-in. (1829-mm) Straight Section with knockouts      | —                               | —                               | F44T172GVPWK                      | F66T172GVPWK                      | —                                 | —                                   | —                                   |
| 72.00-in. (1829-mm) Straight Section without knockouts   | —                               | —                               | F44T172GVP                        | F66T172GVP                        | F88T172GVP                        | F1010T172GVP                        | —                                   |
| 120.00-in. (3048-mm) Straight Section with knockouts     | F22T1120GVPWK                   | —                               | F44T1120GVPWK                     | F66T1120GVPWK                     | F88T1120GVP                       | —                                   | —                                   |
| 120.00-in. (3048-mm) Straight Section without knockouts  | F22T1120GVP                     | F33T1120GVP                     | F44T1120GVP                       | F66T1120GVP                       | F88T1120GVP                       | F1010T1120GVP                       | F1212T1120GVP                       |
| 90° Flush Tee  | F22GT                           | F33GT                           | F44GT                             | F66GT                             | F88GT                             | F1010GT                             | F1212GT                             |
| Sweep Tee  | F22T                            | —                               | F44T                              | F66T                              | F88T                              | F1010T                              | F1212T                              |
| Cross Fitting  | F22X                            | —                               | F44X                              | F66X                              | F88X                              | F1010X                              | F1212X                              |
| 90° Sweep Elbow  | F22G90SE                        | —                               | F44G90SE                          | F66G90SE                          | F88G90SE                          | F1010G90SE                          | F1212G90SE                          |
| 90° Elbow-Tee-Cross                                      | F22G90TX                        | F33G90TX                        | F44G90TX                          | F66G90TX                          | F88G90TX                          | F1010G90TX                          | F1212G90TX                          |
| 90° Elbow  | F22G90E                         | F33G90E                         | F44G90E                           | F66G90E                           | F88G90E                           | F1010G90E                           | F1212G90E                           |
| 90° Elbow Outside Opening                                | F2290EOUT                       | —                               | F4490EOUT                         | F6690EOUT                         | F8890EOUT                         | F101090EOUT                         | F121290EOUT                         |
| 90° Elbow Inside Opening                                 | F2290EIN                        | —                               | F4490EIN                          | F6690EIN                          | F8890EIN                          | F101090EIN                          | F121290EIN                          |
| 45° Elbow  | F22G45E                         | F33G45E                         | F44G45E                           | F66G45E                           | F88G45E                           | F1010G45E                           | F1212G45E                           |
| Telescope Fitting <sup>a</sup>                           | F22GA                           | —                               | F44GA                             | F66GA                             | F88GA                             | F1010GA                             | F1212GA                             |
| Open Adapter   | F22GOA                          | —                               | F44GOA                            | F66GOA                            | F88GOA                            | F1010GOA                            | F1212GOA                            |
| Panel Adapter  | F22GPA                          | F33GPA                          | F44GPA                            | F66GPA                            | F88GPA                            | F1010GPA                            | F1212GPA                            |
| Closure Plate with knockouts                             | F22GCP                          | —                               | F44GCP                            | F66GCP                            | F88GCP                            | F1010GCP                            | F1212GCP                            |
| Closure Plate without knockouts                          | F22GCPNK                        | F33GCPNK                        | F44GCPNK                          | F66GCPNK                          | F88GCPNK                          | F1010GCPNK                          | F1212GCPNK                          |
| Reducer  | —                               | F33G22R                         | F44G22R                           | F66G44R                           | F88G66R                           | F1010G88R                           | F1212G1010R                         |
| Drop and Bracket Hanger                                  | F22GDB                          | —                               | F44GDB                            | F66GDB                            | F88GDB                            | F1010GDB                            | F1212GDB                            |
| Support Hanger   | F22GSH                          | —                               | F44GSH                            | F66GSH                            | F88GSH                            | F1010GSH                            | F1212GSH                            |
| Universal U-Connector                                    | F22GUC                          | F33GUC                          | F44GUC                            | F66GUC                            | F88GUC                            | F1010GUC                            | F1212GUC                            |
| Barrier Kit, bolt-on<br>Each barrier 60.00 in. (1524 mm) | —                               | F33BK60                         | F44BK60                           | F66BK60                           | F88BK60                           | —                                   | —                                   |

<sup>a</sup>Not UL/cUL listed.

**STRAIGHT SECTION**

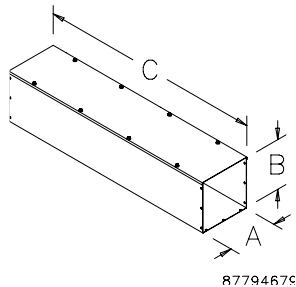

Protects electrical wiring in applications where dust, dirt, oil and water are not serious problems. All sections and fittings are completely open on one side so wires and cables can be laid in along wireway run. No pulling through of wires or cables prevents damage to insulation that often occurs in a pull-through wiring system. Flat cover design allows for mounting flush with walls or ceilings. Keyhole screw slots on flat covers provide easy access.

**BULLETIN: F40FC, F40G**

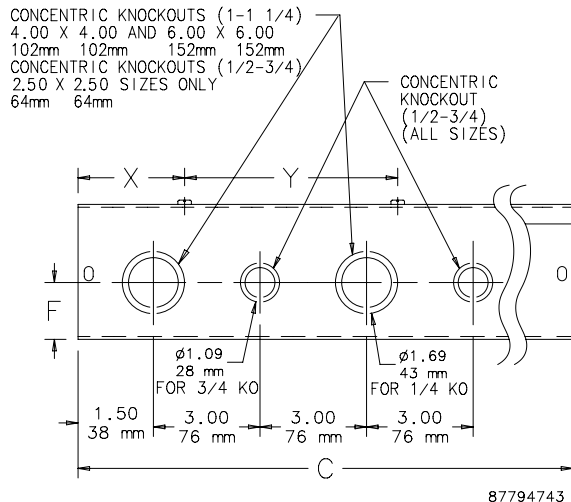

PATTERN REPEATS EVERY 12.00  
305 mm



### 90-DEGREE FLUSH TEE

For flush mounting against a vertical or horizontal surface.

BULLETIN: F40PF

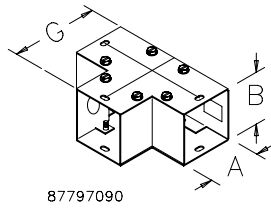

| Catalog Number | AxB in./mm                 | G in./mm     |
|----------------|----------------------------|--------------|
| F22GT          | 2.50 x 2.50<br>64 x 64     | 4.50<br>114  |
| F33GT          | 3.00 x 3.00<br>76 x 76     | 5.00<br>127  |
| F44GT          | 4.00 x 4.00<br>102 x 102   | 6.00<br>152  |
| F66GT          | 6.00 x 6.00<br>152 x 152   | 8.00<br>203  |
| F88GT          | 8.00 x 8.00<br>203 x 203   | 10.00<br>254 |
| F1010GT        | 10.00 x 10.00<br>254 x 254 | 12.00<br>305 |
| F1212GT        | 12.00 x 12.00<br>305 x 305 | 14.00<br>356 |

### SWEEP TEE

For large radius turns. Mounts against vertical or horizontal surfaces. Top and inside covers removable.

BULLETIN: F40PF

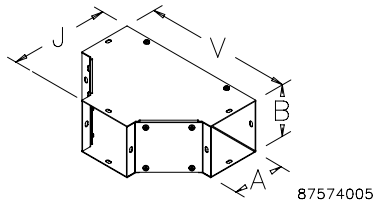

| Catalog Number | AxB in./mm                 | J in./mm     | V in./mm     |
|----------------|----------------------------|--------------|--------------|
| F22T           | 2.50 x 2.50<br>64 x 64     | 6.50<br>165  | 10.35<br>263 |
| F44T           | 4.00 x 4.00<br>102 x 102   | 8.00<br>203  | 11.85<br>301 |
| F66T           | 6.00 x 6.00<br>152 x 152   | 10.00<br>254 | 13.85<br>352 |
| F88T           | 8.00 x 8.00<br>203 x 203   | 12.00<br>305 | 15.84<br>402 |
| F1010T         | 10.00 x 10.00<br>254 x 254 | 14.00<br>356 | 17.84<br>453 |
| F1212T         | 12.00 x 12.00<br>305 x 305 | 16.00<br>406 | 19.84<br>504 |

### CROSS FITTING

For routing cables in four directions. Top, bottom and side covers removable.

BULLETIN: F40PF

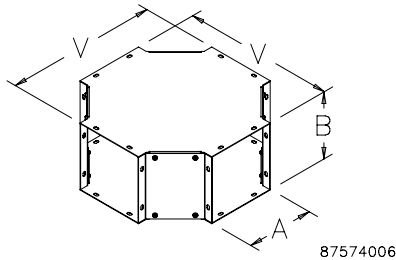

| Catalog Number | AxB in./mm                 | V in./mm     |
|----------------|----------------------------|--------------|
| F22X           | 2.50 x 2.50<br>64 x 64     | 10.35<br>263 |
| F44X           | 4.00 x 4.00<br>102 x 102   | 11.85<br>301 |
| F66X           | 6.00 x 6.00<br>152 x 152   | 13.85<br>352 |
| F88X           | 8.00 x 8.00<br>203 x 203   | 15.84<br>402 |
| F1010X         | 10.00 x 10.00<br>254 x 254 | 17.84<br>453 |
| F1212X         | 12.00 x 12.00<br>305 x 305 | 19.84<br>504 |

### 90-DEGREE SWEEP ELBOW

For large radius turns.

BULLETIN: F40PF

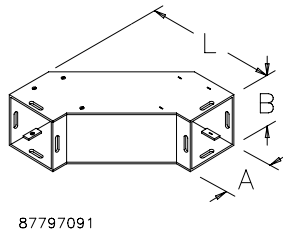

| Catalog Number | AxB in./mm                 | L in./mm     |
|----------------|----------------------------|--------------|
| F22G90SE       | 2.50 x 2.50<br>64 x 64     | 7.91<br>201  |
| F44G90SE       | 4.00 x 4.00<br>102 x 102   | 9.41<br>239  |
| F66G90SE       | 6.00 x 6.00<br>152 x 152   | 11.34<br>288 |
| F88G90SE       | 8.00 x 8.00<br>203 x 203   | 13.44<br>341 |
| F1010G90SE     | 10.00 x 10.00<br>254 x 254 | 15.62<br>395 |
| F1212G90SE     | 12.00 x 12.00<br>305 x 305 | 17.44<br>443 |

### 90-DEGREE ELBOW-TEE-CROSS

Forms left or right 90-degree turns. Can be used as a tee or cross. Use with open adapter for cable entrance in top and bottom. Includes two closure plates.

BULLETIN: F40PF

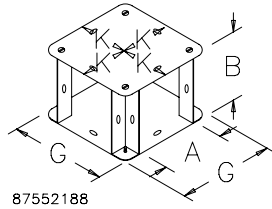

| Catalog Number | AxB in./mm                 | G in./mm     | K in./mm    |
|----------------|----------------------------|--------------|-------------|
| F22G90TX       | 2.50 x 2.50<br>64 x 64     | 4.50<br>114  | 2.25<br>57  |
| F33G90TX       | 3.00 x 3.00<br>76 x 76     | 5.00<br>127  | 2.50<br>64  |
| F44G90TX       | 4.00 x 4.00<br>102 x 102   | 6.00<br>152  | 3.00<br>76  |
| F66G90TX       | 6.00 x 6.00<br>152 x 152   | 8.00<br>203  | 4.00<br>102 |
| F88G90TX       | 8.00 x 8.00<br>203 x 203   | 10.00<br>254 | 5.00<br>127 |
| F1010G90TX     | 10.00 x 10.00<br>254 x 254 | 12.00<br>305 | 6.00<br>152 |
| F1212G90TX     | 12.00 x 12.00<br>305 x 305 | 14.00<br>356 | 7.00<br>178 |

### 90-DEGREE ELBOW

Any side can be removed, retaining lay-in feature regardless of how the elbow is oriented. Sides are held together with screws.

BULLETIN: F40PF

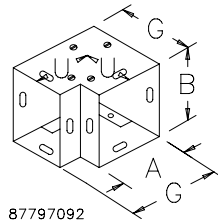

| Catalog Number | AxB in./mm                 | G in./mm     |
|----------------|----------------------------|--------------|
| F22G90E        | 2.50 x 2.50<br>64 x 64     | 4.50<br>114  |
| F33G90E        | 3.00 x 3.00<br>76 x 76     | 5.00<br>127  |
| F44G90E        | 4.00 x 4.00<br>102 x 102   | 6.00<br>152  |
| F66G90E        | 6.00 x 6.00<br>152 x 152   | 8.00<br>203  |
| F88G90E        | 8.00 x 8.00<br>203 x 203   | 10.00<br>254 |
| F1010G90E      | 10.00 x 10.00<br>254 x 254 | 12.00<br>305 |
| F1212G90E      | 12.00 x 12.00<br>305 x 305 | 14.00<br>356 |

### 90-DEGREE ELBOW—OUTSIDE OPENING

For continuous run with 90-degree turns. Top, bottom and outside covers removable.

BULLETIN: F40PF

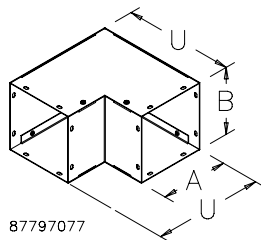

| Catalog Number | AxB in./mm                 | U in./mm     |
|----------------|----------------------------|--------------|
| F2290EOUT      | 2.50 x 2.50<br>64 x 64     | 6.50<br>165  |
| F4490EOUT      | 4.00 x 4.00<br>102 x 102   | 8.00<br>203  |
| F6690EOUT      | 6.00 x 6.00<br>152 x 152   | 10.00<br>254 |
| F8890EOUT      | 8.00 x 8.00<br>203 x 203   | 12.00<br>305 |
| F101090EOUT    | 10.00 x 10.00<br>254 x 254 | 14.00<br>356 |
| F121290EOUT    | 12.00 x 12.00<br>305 x 305 | 16.00<br>406 |

### 90-DEGREE ELBOW—INSIDE OPENING

For continuous run with 90-degree turns. Top and inside covers removable.

BULLETIN: F40PF

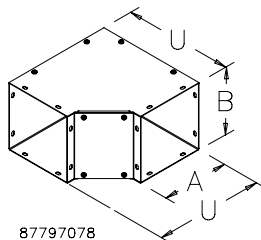

| Catalog Number | AxB in./mm                 | U in./mm     |
|----------------|----------------------------|--------------|
| F2290EIN       | 2.50 x 2.50<br>64 x 64     | 6.50<br>165  |
| F4490EIN       | 4.00 x 4.00<br>102 x 102   | 8.00<br>203  |
| F6690EIN       | 6.00 x 6.00<br>152 x 152   | 10.00<br>254 |
| F8890EIN       | 8.00 x 8.00<br>203 x 203   | 12.00<br>305 |
| F101090EIN     | 10.00 x 10.00<br>254 x 254 | 14.00<br>356 |
| F121290EIN     | 12.00 x 12.00<br>305 x 305 | 16.00<br>406 |

### 45-DEGREE ELBOW

For continuous run with 45-degree turns. Top and inside covers removable.

BULLETIN: F40PF

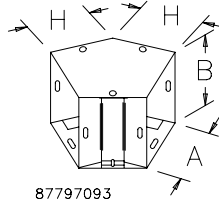

| Catalog Number | AxB in./mm                 | H in./mm    |
|----------------|----------------------------|-------------|
| F22G45E        | 2.50 x 2.50<br>64 x 64     | 2.75<br>70  |
| F33G45E        | 3.00 x 3.00<br>76 x 76     | 2.99<br>76  |
| F44G45E        | 4.00 x 4.00<br>102 x 102   | 3.38<br>86  |
| F66G45E        | 6.00 x 6.00<br>152 x 152   | 4.25<br>108 |
| F88G45E        | 8.00 x 8.00<br>203 x 203   | 5.06<br>129 |
| F1010G45E      | 10.00 x 10.00<br>254 x 254 | 6.00<br>152 |
| F1212G45E      | 12.00 x 12.00<br>305 x 305 | 6.75<br>171 |

### TELESCOPE FITTING

Length easily adjusts to approximately 12.00 in. (305 mm). No cutting or welding required.

BULLETIN: F40PF

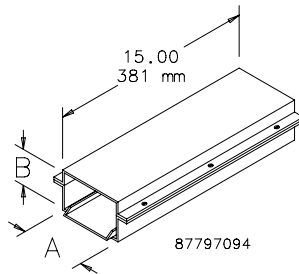

| Catalog Number | AxB in./mm                 |
|----------------|----------------------------|
| F22GA          | 2.50 x 2.50<br>64 x 64     |
| F44GA          | 4.00 x 4.00<br>102 x 102   |
| F66GA          | 6.00 x 6.00<br>152 x 152   |
| F88GA          | 8.00 x 8.00<br>203 x 203   |
| F1010GA        | 10.00 x 10.00<br>254 x 254 |
| F1212GA        | 12.00 x 12.00<br>305 x 305 |

These items not UL/cUL listed.

### OPEN ADAPTER

Used with the 90-Degree Elbow-Tee-Cross fitting to permit a run directly up or down.

BULLETIN: F40PF

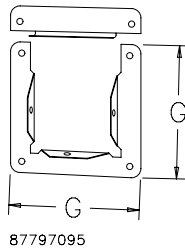

| Catalog Number | G (in.) | G (mm) |
|----------------|---------|--------|
| F22GOA         | 4.50    | 114    |
| F44GOA         | 6.00    | 152    |
| F66GOA         | 8.00    | 203    |
| F88GOA         | 10.00   | 254    |
| F1010GOA       | 12.00   | 305    |
| F1212GOA       | 14.00   | 356    |

### PANEL ADAPTER

A flanged fitting which allows the wireway to be securely connected to an enclosure.

BULLETIN: F40PF

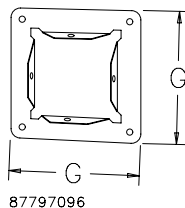

| Catalog Number | G (in.) | G (mm) |
|----------------|---------|--------|
| F22GPA         | 4.50    | 114    |
| F33GPA         | 5.00    | 127    |
| F44GPA         | 6.00    | 152    |
| F66GPA         | 8.00    | 203    |
| F88GPA         | 10.00   | 254    |
| F1010GPA       | 12.00   | 305    |
| F1212GPA       | 14.00   | 356    |

### CLOSURE PLATE

Closes the end of a wireway section or run.

BULLETIN: F40PF

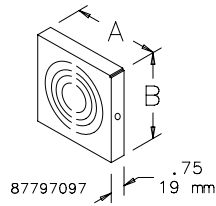

| Catalog Number | AxB in.       | AxB mm    | Knockouts         |
|----------------|---------------|-----------|-------------------|
| F22GCP         | 2.50 x 2.50   | 64 x 64   | With knockouts    |
| F22GCPNK       | 2.50 x 2.50   | 64 x 64   | Without knockouts |
| F44GCP         | 4.00 x 4.00   | 102 x 102 | With knockouts    |
| F33GCPNK       | 3.00 x 3.00   | 76 x 76   | Without knockouts |
| F44GCPNK       | 4.00 x 4.00   | 102 x 102 | Without knockouts |
| F66GCP         | 6.00 x 6.00   | 152 x 152 | With knockouts    |
| F66GCPNK       | 6.00 x 6.00   | 152 x 152 | Without knockouts |
| F88GCP         | 8.00 x 8.00   | 203 x 203 | With knockouts    |
| F88GCPNK       | 8.00 x 8.00   | 203 x 203 | Without knockouts |
| F1010GCP       | 10.00 x 10.00 | 254 x 254 | With knockouts    |
| F1010GCPNK     | 10.00 x 10.00 | 254 x 254 | Without knockouts |
| F1212GCP       | 12.00 x 12.00 | 305 x 305 | With knockouts    |
| F1212GCPNK     | 12.00 x 12.00 | 305 x 305 | Without knockouts |

### DROP AND BRACKET HANGERS

Drop and bracket hangers support a wireway run.

BULLETIN: F40PF

| Catalog Number | N max. (in.) | N max. (mm) | P (in.) | P (mm) | R (in.) | R (mm) | S (in.) | S (mm) | T (in.) | T (mm) |
|----------------|--------------|-------------|---------|--------|---------|--------|---------|--------|---------|--------|
| F22GDB         | 8.50         | 216         | 4.50    | 114    | 3.38    | 86     | 7.25    | 184    | 3.75    | 95     |
| F44GDB         | 10.50        | 267         | 6.00    | 152    | 4.12    | 105    | 9.25    | 235    | 4.50    | 114    |
| F66GDB         | 15.00        | 381         | 7.12    | 181    | 5.12    | 130    | 13.75   | 349    | 5.50    | 140    |
| F88GDB         | 21.00        | 533         | 10.81   | 275    | 7.00    | 178    | 13.75   | 349    | 7.75    | 197    |
| F1010GDB       | 22.00        | 559         | 13.81   | 335    | 8.38    | 213    | 13.75   | 349    | 10.25   | 260    |
| F1212GDB       | 23.00        | 584         | 15.56   | 395    | 9.78    | 248    | 13.75   | 349    | 12.50   | 318    |

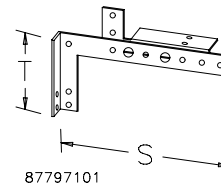
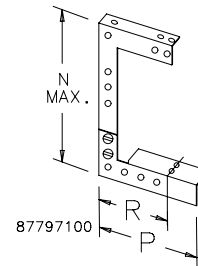

### SUPPORT HANGER

For floor or wall installations.

BULLETIN: F40PF

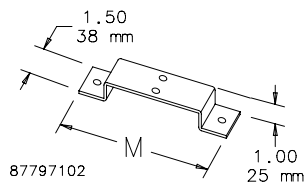

| Catalog Number | AxB in./mm                 | M in./mm     |
|----------------|----------------------------|--------------|
| F22GSH         | 2.50 x 2.50<br>64 x 64     | 4.62<br>117  |
| F44GSH         | 4.00 x 4.00<br>102 x 102   | 6.12<br>155  |
| F66GSH         | 6.00 x 6.00<br>152 x 152   | 8.12<br>206  |
| F88GSH         | 8.00 x 8.00<br>203 x 203   | 10.12<br>257 |
| F1010GSH       | 10.00 x 10.00<br>254 x 254 | 12.12<br>308 |
| F1212GSH       | 12.00 x 12.00<br>305 x 305 | 14.12<br>359 |

### UNIVERSAL U-CONNECTOR

Joins wireway sections and fittings. Top swings aside to retain the lay-in feature. One U-connector required at each wireway joint except telescope fittings, panel adapters, open adapters, closure plates or reducers.

BULLETIN: F40PF

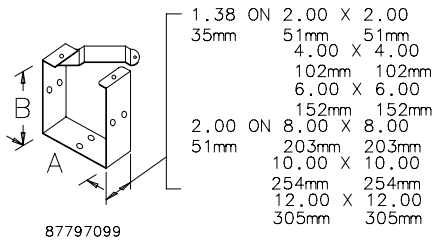

87797099

| Catalog Number | AxB in./mm                 |
|----------------|----------------------------|
| F22GUC         | 2.50 x 2.50<br>64 x 64     |
| F33GUC         | 3.00 x 3.00<br>76 x 76     |
| F44GUC         | 4.00 x 4.00<br>102 x 102   |
| F66GUC         | 6.00 x 6.00<br>152 x 152   |
| F88GUC         | 8.00 x 8.00<br>203 x 203   |
| F1010GUC       | 10.00 x 10.00<br>254 x 254 |
| F1212GUC       | 12.00 x 12.00<br>305 x 305 |

### BARRIER KIT, BOLT-ON

Divides wireway into two or more compartments. Barriers are fastened to wireway sections with screws. Sealing washers are included.

BULLETIN: F20

| Catalog Number | W in./mm    |
|----------------|-------------|
| F33BK60        | 2.00<br>51  |
| F44BK60        | 3.00<br>76  |
| F66BK60        | 4.50<br>114 |
| F88BK60        | 6.00<br>152 |

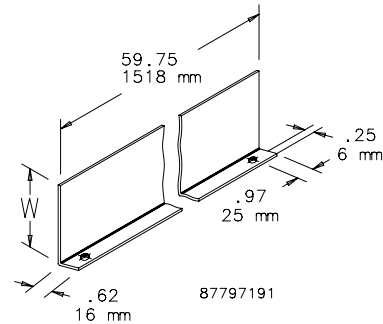

### REDUCER

Reduces wireway to a smaller size.

BULLETIN: F40PF

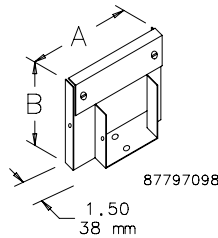

87797098

| Catalog Number | AxB in./mm                 |
|----------------|----------------------------|
| F33G22R        | 3.00 x 3.00<br>76 x 76     |
| F44G22R        | 4.00 x 4.00<br>102 x 102   |
| F44G33R        | 4.00 x 4.00<br>101 x 101   |
| F66G44R        | 6.00 x 6.00<br>152 x 152   |
| F88G66R        | 8.00 x 8.00<br>203 x 203   |
| F1010G88R      | 10.00 x 10.00<br>254 x 254 |
| F1212G88R      | 12.00 x 12.00<br>305 x 305 |
| F1212G1010R    | 12.00 x 12.00<br>305 x 305 |



## **X-ON Electronics**

Largest Supplier of Electrical and Electronic Components

*Click to view similar products for [Hoffman](#) manufacturer:*

Other Similar products are found below :

[A-1412CHQR](#) [A-6P4G](#) [A-202408LP](#) [CSD20168SS](#) [CSD20206](#) [CSD20208SS](#) [CSD24168](#) [CSD36248](#) [CSD36308](#) [PCU7](#) [PDS76R](#)  
[PRA197TP](#) [PT126](#) [A10086CH](#) [A1008CHNFSS](#) [A10106CH](#) [A10106CHFL](#) [A10106PHCW](#) [A1043DSC](#) [A1066JFGQRR](#) [A12106CHQRFG](#)  
[A1212SC](#) [A1412CHNFSS](#) [A161208LP](#) [A161410CH](#) [A16148CHQRFG](#) [A16H12ALP](#) [A18P16AL](#) [A24H2408SSLP](#) [A24H24BLP](#)  
[Q13138PCE](#) [A36P24](#) [Q3PBPCDM](#) [A404CH](#) [A606CHNF](#) [A606NF](#) [A806SC](#) [A845JFGR](#) [A864CHQRFGW](#) [A90P36F1](#) [HJ1412HWPL2LG](#)  
[HJ1816HWPL2LG](#) [RHJ1210HWPL2LG](#) [AS125SS](#) [ASE10X10X4](#) [ASE12X12X4](#) [E1PBG](#) [E2PBG](#) [E3PB](#) [LED24V15](#)