

LR Position Switches

- Technopolymer housing, one conduit entry
- Protection degree IP67 according to EN 60529
- 17 contact blocks available
- 48 actuators available
- M12 assembled connector versions
- Silver contacts gold plated versions
- Other versions available (see LM, LX, LZ datasheets)



Approvals



General data

Ambient temperature:	-25°C ... +80°C
Max. actuation frequency:	3600 operating cycles ¹ /hour
Mechanical endurance:	20 million operating cycles ¹
Mounting position:	any
Safety parameters:	
B _{10d} :	40,000,00 for NC contacts
Mechanical interlock, not coded:	type 1 according to EN ISO 14119

(1) One operation cycle means two movements, one to close and one to open contacts, as defined in EN 60947-5-1.

Cable cross section (flexible copper strands)

Contact blocks C20, C21, C22, C33, C34:	min. 1 x 0.34 mm ²	(1 x AWG 22)
	max. 2 x 1.5 mm ²	(2 x AWG 16)
Contact block C5, C6, C7, C9, C10, C11, C12, C13, C14, C15, C16, C18:	min. 1 x 0.5 mm ²	(1 x AWG 20)
	max. 2 x 2.5 mm ²	(2 x AWG 14)
Contact block C2:	min. 1 x 0.5 mm ²	(1 x AWG 20)
	max. 2 x 1.5 mm ²	(2 x AWG 16)

In conformity with standards:

IEC 60947-5-1, EN 60947-5-1, EN 60947-1, EN 50047, IEC 60204-1, EN 60204-1, EN ISO 14119, EN ISO 12100, IEC 60529, EN 60529, UL 508, CSA 22.2 No. 14 .

Approvals:

IEC 60947-5-1, UL 508, CSA 22.2 No.14, GB14048.5-2001.

In conformity with the requirements of:

Low Voltage Directive 2006/95/EC, Machinery Directive 2006/42/EC and EMC Directive 2004/108/EC.

Positive contact opening in conformity with standards:

IEC 60947-5-1, EN 60947-5-1.

Installation for safety applications:

Use only switches marked with the symbol ⊕ aside the product code. Always connect the safety circuit to the **NC contacts** (normally closed contacts: C11-C12, C21-C22 or C31-C32) as stated in **standard EN 60947-5-1, encl. K, par. 2**. Actuate the switch **at least up to the positive opening travel** shown in the travel diagrams. Operate the switch **at least with the positive opening force**, indicated between brackets below each article, aside the minimum force value.

Electrical data

Utilization category

without connector	Thermal current (I _{th}):	10 A	Alternating current: AC15 (50 ÷ 60 Hz)			
	Rated insulation voltage (U _i):	500 Vac 600 Vdc	Ue (V)	250	400	500
		400 Vac 500 Vdc (contact blocks 2, 11, 12, 20, 21, 22, 33, 34)	Ie (A)	6	4	1
	Rated impulse withstand voltage (U _{imp}):	6 kV	Direct current: DC13			
	4 kV (contact blocks 20, 21, 22, 33, 34)	Ue (V)	24	125	250	
Conditional short circuit current:	1000 A according to EN 60947-5-1	Ie (A)	6	1.1	0.4	
Protection against short circuits:	type aM fuse 10 A 500 V					
Pollution degree:	3					

with connector M12, 4 poles	Thermal current (I _{th}):	4 A	Alternating current: AC15 (50 ÷ 60 Hz)			
	Rated insulation voltage (U _i):	250 Vac 300 Vdc	Ue (V)	24	120	250
	Protection against short circuits:	type gG fuse 4 A 500 V	Ie (A)	4	4	4
	Pollution degree:	3	Direct current: DC13			
Ue (V)	24	125	250			
Ie (A)	4	1.1	0.4			

with connector M12, 8 poles	Thermal current (I _{th}):	2 A	Alternating current: AC15 (50 ÷ 60 Hz)		
	Rated insulation voltage (U _i):	30 Vac 36 Vdc	Ue (V)	24	
	Protection against short circuits:	type gG fuse 2 A 500 V	Ie (A)	2	
	Pollution degree:	3	Direct current: DC13		
Ue (V)	24				
Ie (A)	2				

Specifications

Rated insulation voltage (Ui): 500 Vac
 400 Vac (for contact blocks C2, C11, C12, C20, C21, C22, C33, C34)

Conventional free air thermal current (Ith): 10 A

Protection against short circuits: type aM fuse 10 A 500 V

Rated impulse withstand voltage (U_{imp}): 6 kV
 4 kV (for contact blocks C20, C21, C22, C33, C34)

Protection degree of the housing: IP67

MV terminals (screw terminals)

Pollution degree 3

Utilization category: AC15

Operating voltage (Ue): 400 Vac (50 Hz)

Operating current (Ie): 3 A

Forms of the contact element: Za, Zb, Za+Za, Y+Y, X+X, Y+Y+X, Y+Y+Y, Y+X+X

Positive opening of contacts on contact blocks C5, C6, C7, C9, C11, C13, C14, C16, C18, C20, C21, C22, C33, C34

In conformity with standards: EN 60947-1, EN 60947-5-1 + A1:2009, fundamental requirements of the Low Voltage Directive 2006/95/EC.

Please contact our technical service for the list of approved products.

UL Approval

Utilization categories Q300 (69 VA, 125 ... 250 Vdc)
 A600 (720 VA, 120 ... 600 Vac)

Data of housing type 1, 4X "indoor use only", 12, 13

For all contact blocks except C2 and C3 use 60 or 75°C copper (Cu) conductor, rigid or flexible, wire size AWG 12/14. Terminal tightening torque of 7.1 lb in (0.8 Nm).

For contact blocks C2 and C3 use 60 or 75 °C copper (Cu) conductor, rigid or flexible, wire size AWG 14. Terminal tightening torque of 12 lb in (1.4 Nm).

In conformity with standard: UL 508, CSA 22.2 No.14

Please contact our technical service for the list of approved products.

Connection diagram for M12 connectors

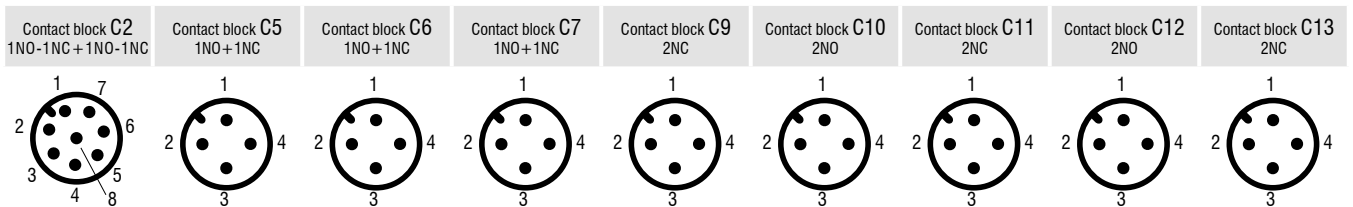

M12 connector, 8 poles M12 connector, 4 poles M12 connector, 4 poles M12 connector, 4 poles M12 connector, 4 poles M12 connector, 4 poles M12 connector, 4 poles M12 connector, 4 poles M12 connector, 4 poles M12 connector, 4 poles

Contact block C2	Contact block C5	Contact block C6	Contact block C7	Contact block C9	Contact block C10	Contact block C11	Contact block C12	Contact block C13
NO 3-4	NC 1-2	NC 1-2	NC 1-2	NC 1-2	NO 1-2	NC 1-2	NO 1-2	NC (1 ^o) 1-2
NC 5-6	NO 3-4	NO 3-4	NO 3-4	NC 3-4	NO 3-4	NC 3-4	NO 3-4	NC (2 ^o) 3-4
NC 7-8								
NO 1-2								

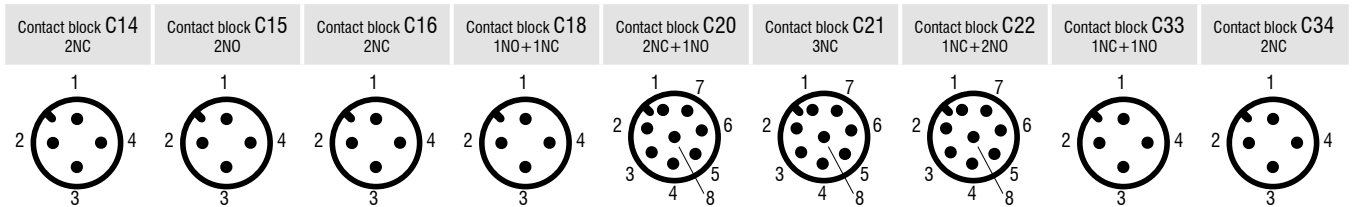

M12 connector, 4 poles M12 connector, 4 poles M12 connector, 4 poles M12 connector, 4 poles M12 connector, 8 poles M12 connector, 8 poles M12 connector, 8 poles M12 connector, 4 poles M12 connector, 4 poles

Contact block C14	Contact block C15	Contact block C16	Contact block C18	Contact block C20	Contact block C21	Contact block C22	Contact block C33	Contact block C34
NC (1 ^o) 1-2	NO (1 ^o) 1-2	NC, lever at the right 1-2	NC 1-2	NC 3-4	NC 3-4	NC 3-4	NC 1-2	NC 1-2
NC (2 ^o) 3-4	NO (2 ^o) 3-4	NC, lever to the left 3-4	NO 3-4	NC 5-6	NC 5-6	NO 5-6	NO 3-4	NC 3-4
				NO 7-8	NC 7-8	NO 7-8		

Contact block E1
PNP

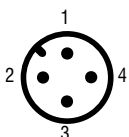

M12 connector, 4 poles

Contacts	Pin no.
+	1
-	3
NC	2
NO	4

Selection diagram

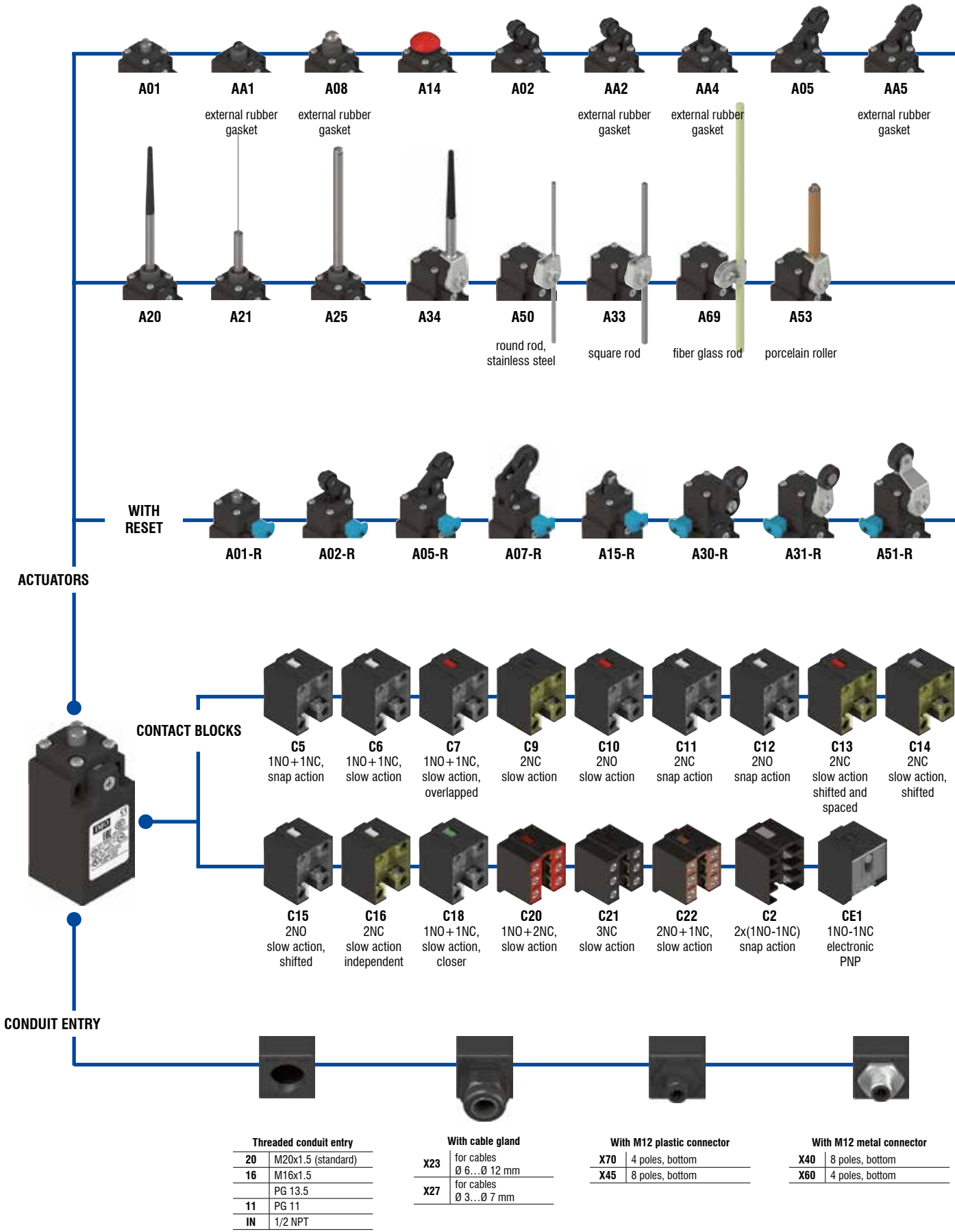

product options
 accessory sold separately



A07



AA7
external rubber
gasket



A15
roller
Ø 11 mm



A15-R28
roller
Ø 12 mm,
stainless steel



A16
roller
Ø 20 mm



A10



A17
roller
Ø 12 mm,
stainless steel



A12



A13
roller
Ø 12 mm,
stainless steel



A76
rope switch for
signalling



A30



A31



A51



A52



A54



A55
adjustable
lever



A56
adjustable
safety lever



A57



A38

without actuator



A52-R



A54-R



A56-R



A57-R



A38-R
without actuator



Options & Ordering Codes

Attention! The feasibility of a code number does not mean the effective availability of a product. Please contact our sales office.

	LR	C5	A02	1	R	SS	20	X70	
Housing	polymer, one conduit entry								Preinstalled Cable Gland or Connectors
	LR								no cable gland or connector (standard)
Contact Blocks									X21 assembled cable gland
1NO+1NC, snap action		C5							X70 4 poles M12 assembled plastic connector
1NO+1NC, slow action		C6							
1NO+1NC, slow action, overlapped		C7							
.....		...							
Other contact blocks available upon request									Threaded Conduit Entry
Actuators									11 PG 13.5 (standard)
short plunger			A01						16 PG 11
roller lever			A02						20 M16 x 1.5
offset roller lever			A05						IN M20 x 1.5
Other actuators available upon request									1/2 NPT
Suffix									External Metallic Parts
no suffix (standard)									zinc plated steel (standard)
with stainless steel roller: - Ø 12mm for actuators AA4, A15 - Ø 14mm for actuators A2, A02, A5, A05 - Ø 20mm for actuators A30, A31, A51, A52, A54, A55, A56, A57				1					SS stainless steel
with Ø 35mm polymer roller				2					Reset Hooking
with Ø 50mm rubber roller				3					without reset (standard)
with Ø 50mm overhanging rubber roller				4	R	simultaneous reset			RI simultaneous reset with increased force

Contact type:

- R** = snap action
- L** = slow action
- LO** = slow action overlapped
- LS** = slow action shifted
- LV** = slow action shifted and spaced
- LI** = slow action independent
- LA** = slow action closer
- △** = electronic PNP

Contact blocks

		With external rubber gasket	With stainless steel roller on request	With external rubber gasket	With stainless steel roller on request
C5	R	LRC5A01 → 1NO+1NC	LRC5AA1 → 1NO+1NC	LRC5A02 → 1NO+1NC	LRC5AA2 → 1NO+1NC
C6	L	LRC6A01 → 1NO+1NC	LRC6AA1 → 1NO+1NC	LRC6A02 → 1NO+1NC	LRC6AA2 → 1NO+1NC
C7	LO	LRC7A01 → 1NO+1NC	LRC7AA1 → 1NO+1NC	LRC7A02 → 1NO+1NC	LRC7AA2 → 1NO+1NC
C9	L	LRC9A01 → 2NC	LRC9AA1 → 2NC	LRC9A02 → 2NC	LRC9AA2 → 2NC
C10	L	LRC10A01 2NO	LRC10AA1 2NO	LRC10A02 2NO	LRC10AA2 2NO
C11	R	LRC11A01 → 2NC	LRC11AA1 → 2NC	LRC11A02 → 2NC	LRC11AA2 → 2NC
C12	R	LRC12A01 2NO	LRC12AA1 2NO	LRC12A02 2NO	LRC12AA2 2NO
C13	LV	LRC13A01 → 2NC	LRC13AA1 → 2NC	LRC13A02 → 2NC	LRC13AA2 → 2NC
C14	LS	LRC14A01 → 2NC	LRC14AA1 → 2NC	LRC14A02 → 2NC	LRC14AA2 → 2NC
C15	LS	LRC15A01 2NO	LRC15AA1 2NO	LRC15A02 2NO	LRC15AA2 2NO
C18	LA	LRC18A01 → 1NO+1NC	LRC18AA1 → 1NO+1NC	LRC18A02 → 1NO+1NC	LRC18AA2 → 1NO+1NC
C20	L	LRC20A01 → 1NO+2NC	LRC20AA1 → 1NO+2NC	LRC20A02 → 1NO+2NC	LRC20AA2 → 1NO+2NC
C21	L	LRC21A01 → 3NC	LRC21AA1 → 3NC	LRC21A02 → 3NC	LRC21AA2 → 3NC
C22	L	LRC22A01 → 2NO+1NC	LRC22AA1 → 2NO+1NC	LRC22A02 → 2NO+1NC	LRC22AA2 → 2NO+1NC
C2	R	LRC2A01 2x(1NO-1NC)	LRC2A01 2x(1NO-1NC)	LRC2A02 2x(1NO-1NC)	LRC2A02 2x(1NO-1NC)
CE1	△	LRCE1A01 1NO-1NC	LRCE1AA1 1NO-1NC	LRCE1A02 1NO-1NC	LRCE1AA2 1NO-1NC
Max. speed		Type 4	Type 4	Type 3	Type 3
Min. force		8 N (25 N →)	6 N (25 N →)	6 N (25 N →)	4.3 N (25 N →)
Travel diagrams		Group 1	Group 1	Group 2	Group 2

		With external rubber gasket	With stainless steel roller on request	With external rubber gasket	With stainless steel roller on request
C5	R	LRC5AA4 → 1NO+1NC	LRC5A05 → 1NO+1NC	LRC5AA5 → 1NO+1NC	LRC5A07 → 1NO+1NC
C6	L	LRC6AA4 → 1NO+1NC	LRC6A05 → 1NO+1NC	LRC6AA5 → 1NO+1NC	LRC6A07 → 1NO+1NC
C7	LO	LRC7AA4 → 1NO+1NC	LRC7A05 → 1NO+1NC	LRC7AA5 → 1NO+1NC	LRC7A07 → 1NO+1NC
C9	L	LRC9AA4 → 2NC	LRC9A05 → 2NC	LRC9AA5 → 2NC	LRC9A07 → 2NC
C10	L	LRC10AA4 2NO	LRC10A05 2NO	LRC10AA5 2NO	LRC10A07 2NO
C11	R	LRC11AA4 → 2NC	LRC11A05 → 2NC	LRC11AA5 → 2NC	LRC11A07 → 2NC
C12	R	LRC12AA4 2NO	LRC12A05 2NO	LRC12AA5 2NO	LRC12A07 2NO
C13	LV	LRC13AA4 → 2NC	LRC13A05 → 2NC	LRC13AA5 → 2NC	LRC13A07 → 2NC
C14	LS	LRC14AA4 → 2NC	LRC14A05 → 2NC	LRC14AA5 → 2NC	LRC14A07 → 2NC
C15	LS	LRC15AA4 2NO	LRC15A05 2NO	LRC15AA5 2NO	LRC15A07 2NO
C18	LA	LRC18AA4 → 1NO+1NC	LRC18A05 → 1NO+1NC	LRC18AA5 → 1NO+1NC	LRC18A07 → 1NO+1NC
C20	L	LRC20AA4 → 1NO+2NC	LRC20A05 → 1NO+2NC	LRC20AA5 → 1NO+2NC	LRC20A07 → 1NO+2NC
C21	L	LRC21AA4 → 3NC	LRC21A05 → 3NC	LRC21AA5 → 3NC	LRC21A07 → 3NC
C22	L	LRC22AA4 → 2NO+1NC	LRC22A05 → 2NO+1NC	LRC22AA5 → 2NO+1NC	LRC22A07 → 2NO+1NC
C2	R	LRC2A05 2x(1NO-1NC)	LRC2A05 2x(1NO-1NC)	LRC2AA5 2x(1NO-1NC)	LRC2A07 2x(1NO-1NC)
CE1	△	LRCE1AA4 1NO-1NC	LRCE1A05 1NO-1NC	LRCE1AA5 1NO-1NC	LRCE1A07 1NO-1NC
Max. speed		Type 5	Type 3	Type 3	Type 3
Min. force		6 N (25 N →)	6 N (25 N →)	4.3 N (25 N →)	4 N (25 N →)
Travel diagrams		Group 1	Group 2	Group 2	Group 3

All measures in the drawings are in mm

Contact type:

- R** = snap action
- L** = slow action
- LO** = slow action overlapped
- LS** = slow action shifted
- LV** = slow action shifted and spaced
- LI** = slow action independent
- LA** = slow action closer
- = electronic PNP

Contact blocks

With external rubber gasket

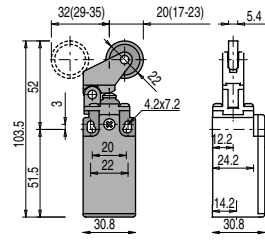

With external rubber gasket

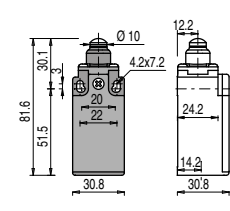

Fixed only by threaded head in vertical position

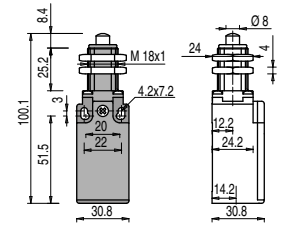
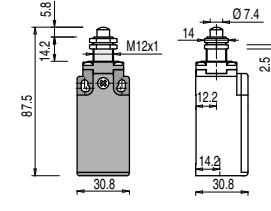

C5	R	LRC5AA7	➔	1NO+1NC	LRC5A08	➔	1NO+1NC	LRC5A10	➔	1NO+1NC	LRC5A12	➔	1NO+1NC
C6	L	LRC6AA7	➔	1NO+1NC	LRC6A08	➔	1NO+1NC	LRC6A10	➔	1NO+1NC	LRC6A12	➔	1NO+1NC
C7	LO	LRC7AA7	➔	1NO+1NC	LRC7A08	➔	1NO+1NC	LRC7A10	➔	1NO+1NC	LRC7A12	➔	1NO+1NC
C9	L	LRC9AA7	➔	2NC	LRC9A08	➔	2NC	LRC9A10	➔	2NC	LRC9A12	➔	2NC
C10	L	LRC10AA7		2NO	LRC10A08		2NO	LRC10A10		2NO	LRC10A12		2NO
C11	R	LRC11AA7	➔	2NC	LRC11A08	➔	2NC	LRC11A10	➔	2NC	LRC11A12	➔	2NC
C12	R	LRC12AA7		2NO	LRC12A08		2NO	LRC12A10		2NO	LRC12A12		2NO
C13	LV	LRC13AA7	➔	2NC	LRC13A08	➔	2NC	LRC13A10	➔	2NC	LRC13A12	➔	2NC
C14	LS	LRC14AA7	➔	2NC	LRC14A08	➔	2NC	LRC14A10	➔	2NC	LRC14A12	➔	2NC
C15	LS	LRC15AA7		2NO	LRC15A08		2NO	LRC15A10		2NO	LRC15A12		2NO
C18	LA	LRC18AA7	➔	1NO+1NC	LRC18A08	➔	1NO+1NC	LRC18A10	➔	1NO+1NC	LRC18A12	➔	1NO+1NC
C20	L	LRC20AA7	➔	1NO+2NC	LRC20A08	➔	1NO+2NC	LRC20A10	➔	1NO+2NC	LRC20A12	➔	1NO+2NC
C21	L	LRC21AA7	➔	3NC	LRC21A08	➔	3NC	LRC21A10	➔	3NC	LRC21A12	➔	3NC
C22	L	LRC22AA7	➔	2NO+1NC	LRC22A08	➔	2NO+1NC	LRC22A10	➔	2NO+1NC	LRC22A12	➔	2NO+1NC
C2	R	LRC2AA7		2x(1NO-1NC)	LRC2A08		2x(1NO-1NC)	LRC2A10		2x(1NO-1NC)	LRC2A12		2x(1NO-1NC)
CE1		LRCE1AA7		1NO-1NC	LRCE1A08		1NO-1NC	LRCE1A10		1NO-1NC	LRCE1A12		1NO-1NC
Max. speed		Type 3			Type 4			Type 4			Type 4		
Min. force		3 N (25 N ➔)			8 N (25 N ➔)			8 N (25 N ➔)			8 N (25 N ➔)		
Travel diagrams		Group 3			Group 1			Group 1			Group 1		

Contact blocks

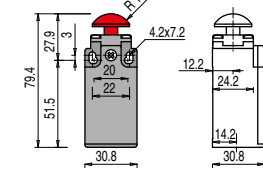
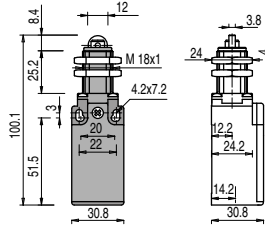

Roller, Ø 11 mm, technopolymer

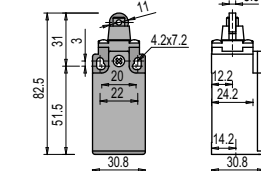

Roller, Ø 12 mm, stainless steel

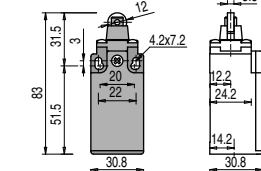

C5	R	LRC5A13	➔	1NO+1NC	LRC5A14	➔	1NO+1NC	LRC5A15	➔	1NO+1NC	LRC5A15-20	➔	1NO+1NC
C6	L	LRC6A13	➔	1NO+1NC	LRC6A14	➔	1NO+1NC	LRC6A15	➔	1NO+1NC	LRC6A15-20	➔	1NO+1NC
C7	LO	LRC7A13	➔	1NO+1NC	LRC7A14	➔	1NO+1NC	LRC7A15	➔	1NO+1NC	LRC7A15-20	➔	1NO+1NC
C9	L	LRC9A13	➔	2NC	LRC9A14	➔	2NC	LRC9A15	➔	2NC	LRC9A15-20	➔	2NC
C10	L	LRC10A13		2NO	LRC10A14		2NO	LRC10A15		2NO	LRC10A15-20		2NO
C11	R	LRC11A13	➔	2NC	LRC11A14	➔	2NC	LRC11A15	➔	2NC	LRC11A15-20	➔	2NC
C12	R	LRC12A13		2NO	LRC12A14		2NO	LRC12A15		2NO	LRC12A15-20		2NO
C13	LV	LRC13A13	➔	2NC	LRC13A14	➔	2NC	LRC13A15	➔	2NC	LRC13A15-20	➔	2NC
C14	LS	LRC14A13	➔	2NC	LRC14A14	➔	2NC	LRC14A15	➔	2NC	LRC14A15-20	➔	2NC
C15	LS	LRC15A13		2NO	LRC15A14		2NO	LRC15A15		2NO	LRC15A15-20		2NO
C18	LA	LRC18A13	➔	1NO+1NC	LRC18A14	➔	1NO+1NC	LRC18A15	➔	1NO+1NC	LRC18A15-20	➔	1NO+1NC
C20	L	LRC20A13	➔	1NO+2NC	LRC20A14	➔	1NO+2NC	LRC20A15	➔	1NO+2NC	LRC20A15-20	➔	1NO+2NC
C21	L	LRC21A13	➔	3NC	LRC21A14	➔	3NC	LRC21A15	➔	3NC	LRC21A15-20	➔	3NC
C22	L	LRC22A13	➔	2NO+1NC	LRC22A14	➔	2NO+1NC	LRC22A15	➔	2NO+1NC	LRC22A15-20	➔	2NO+1NC
C2	R	LRC2A13		2x(1NO-1NC)	LRC2A14		2x(1NO-1NC)	LRC2A15		2x(1NO-1NC)	LRC2A15-20		2x(1NO-1NC)
CE1		LRCE1A13		1NO-1NC	LRCE1A14		1NO-1NC	LRCE1A15		1NO-1NC	LRCE1A15-20		1NO-1NC
Max. speed		Type 2			Type 4			Type 2			Type 2		
Min. force		8 N (25 N ➔)			8 N (25 N ➔)			8 N (25 N ➔)			8 N (25 N ➔)		
Travel diagrams		Group 1			Group 1			Group 1			Group 1		

All measures in the drawings are in mm

Contact type:

- R** = snap action
- L** = slow action
- LO** = slow action overlapped
- LS** = slow action shifted
- LV** = slow action shifted and spaced
- LI** = slow action independent
- LA** = slow action closer
- = electronic PNP

Contact blocks

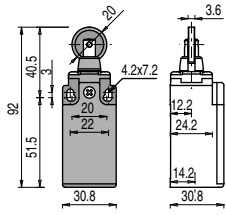

Fixed only by threaded head in vertical position

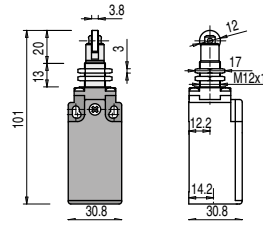

With external rubber gasket

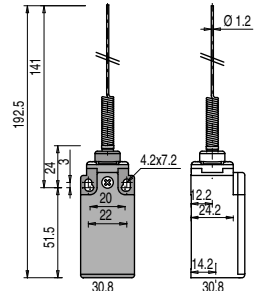
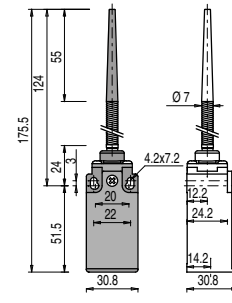

C5	R	LRC5A16-20	1NO+1NC	LRC5A17-20	1NO+1NC	LRC5A20-20	1NO+1NC	LRC5A21-20	1NO+1NC
C6	L	LRC6A16-20	1NO+1NC	LRC6A17-20	1NO+1NC				
C7	LO	LRC7A16-20	1NO+1NC	LRC7A17-20	1NO+1NC				
C9	L	LRC9A16-20	2NC	LRC9A17-20	2NC				
C10	L	LRC10A16-20	2NO	LRC10A17-20	2NO	LRC10A20-20	2NO	LRC10A21-20	2NO
C11	R	LRC11A16-20	2NC	LRC11A17-20	2NC				
C12	R	LRC12A16-20	2NO	LRC12A17-20	2NO	LRC12A20-20	2NO	LRC12A21-20	2NO
C13	LV	LRC13A16-20	2NC	LRC13A17-20	2NC				
C14	LS	LRC14A16-20	2NC	LRC14A17-20	2NC				
C15	LS	LRC15A16-20	2NO	LRC15A17-20	2NO				
C18	LA	LRC18A16-20	1NO+1NC	LRC18A17-20	1NO+1NC	LRC18A20-20	1NO+1NC	LRC18A21-20	1NO+1NC
C20	L	LRC20A16-20	1NO+2NC	LRC20A17-20	1NO+2NC	LRC20A20-20	1NO+2NC	LRC20A21-20	1NO+2NC
C21	L	LRC21A16-20	3NC	LRC21A17-20	3NC	LRC21A20-20	3NC	LRC21A21-20	3NC
C22	L	LRC22A16-20	2NO+1NC	LRC22A17-20	2NO+1NC	LRC22A20-20	2NO+1NC	LRC22A21-20	2NO+1NC
C2	R	LRC2A16-20	2x(1NO-1NC)	LRC2A17-20	2x(1NO-1NC)	LRC2A20-20	2x(1NO-1NC)	LRC2A21-20	2x(1NO-1NC)
CE1		LRCE1A16-20	1NO-1NC	LRCE1A17-20	1NO-1NC	LRCE1A20-20	1NO-1NC	LRCE1A21-20	1NO-1NC
Max. speed		Type 2		Type 2		1 m/s		1 m/s	
Min. force		8 N (25 N \ominus)		8 N (25 N \ominus)		0.07 Nm		0.07 Nm	
Travel diagrams		Group 1		Group 1		Group 4		Group 4	

With external rubber gasket

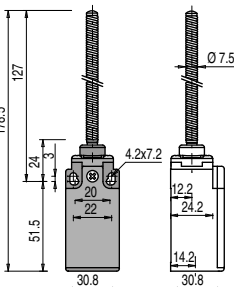

With Ø 20 mm stainless steel roller on request

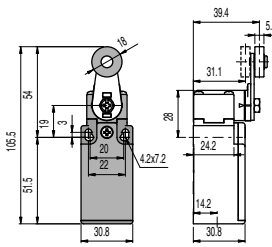
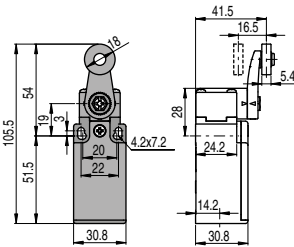

Square rod, 3x3 mm

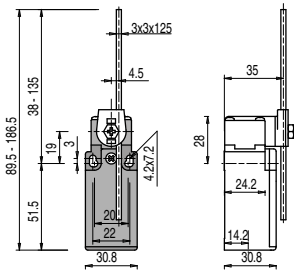

Contact blocks

C5	R	LRC5A25-20	1NO+1NC	LRC5A30-20	1NO+1NC	LRC5A31-20	1NO+1NC	LRC5A33-20	1NO+1NC
C6	L			LRC6A30-20	1NO+1NC	LRC6A31-20	1NO+1NC	LRC6A33-20	1NO+1NC
C7	LO			LRC7A30-20	1NO+1NC	LRC7A31-20	1NO+1NC	LRC7A33-20	1NO+1NC
C9	L			LRC9A30-20	2NC	LRC9A31-20	2NC	LRC9A33-20	2NC
C10	L	LRC10A25-20	2NO	LRC10A30-20	2NO	LRC10A31-20	2NO	LRC10A33-20	2NO
C11	R			LRC11A30-20	2NC	LRC11A31-20	2NC	LRC11A33-20	2NC
C12	R	LRC12A25-20	2NO	LRC12A30-20	2NO	LRC12A31-20	2NO	LRC12A33-20	2NO
C13	LV			LRC13A30-20	2NC	LRC13A31-20	2NC	LRC13A33-20	2NC
C14	LS			LRC14A30-20	2NC	LRC14A31-20	2NC	LRC14A33-20	2NC
C15	LS			LRC15A30-20	2NO	LRC15A31-20	2NO	LRC15A33-20	2NO
C16	LI			LRC16A30-20	2NC	LRC16A31-20	2NC	LRC16A33-20	2NC
C18	LA	LRC18A25-20	1NO+1NC	LRC18A30-20	1NO+1NC	LRC18A31-20	1NO+1NC	LRC18A33-20	1NO+1NC
C20	L	LRC20A25-20	1NO+2NC	LRC20A30-20	1NO+2NC	LRC20A31-20	1NO+2NC	LRC20A33-20	1NO+2NC
C21	L	LRC21A25-20	3NC	LRC21A30-20	3NC	LRC21A31-20	3NC	LRC21A33-20	3NC
C22	L	LRC22A25-20	2NO+1NC	LRC22A30-20	2NO+1NC	LRC22A31-20	2NO+1NC	LRC22A33-20	2NO+1NC
C2	R	LRC2A25-20	2x(1NO-1NC)	LRC2A30-20	2x(1NO-1NC)	LRC2A31-20	2x(1NO-1NC)	LRC2A33-20	2x(1NO-1NC)
CE1		LRCE1A25-20	1NO-1NC	LRCE1A30-20	1NO-1NC	LRCE1A31-20	1NO-1NC	LRCE1A33-20	1NO-1NC
Max. speed		1 m/s		Type 1		Type 1		1.5 m/s	
Min. force		0.12 Nm		0.06 Nm (0.25 Nm \ominus)		0.06 Nm (0.25 Nm \ominus)		0.06 Nm	
Travel diagrams		Group 4		Group 5		Group 5		Group 5	

All measures in the drawings are in mm

Contact type:

- R** = snap action
- L** = slow action
- LO** = slow action overlapped
- LS** = slow action shifted
- LV** = slow action shifted and spaced
- LI** = slow action independent
- LA** = slow action closer
- = electronic PMP

Contact blocks

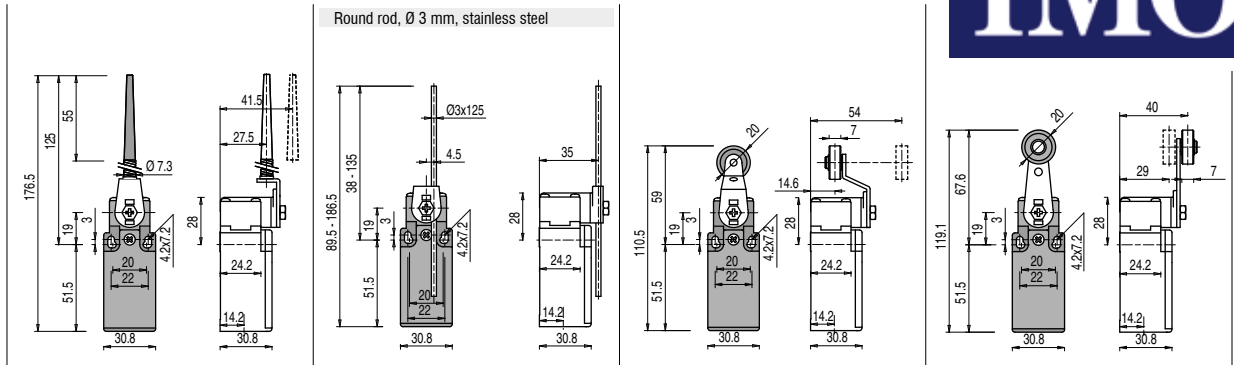

C5	R	LRC5A34-20	1NO+1NC	LRC5A50-20	1NO+1NC	LRC5A51-20	⊕ 1NO+1NC	LRC5A52-20	⊕ 1NO+1NC
C6	L	LRC6A34-20	1NO+1NC	LRC6A50-20	1NO+1NC	LRC6A51-20	⊕ 1NO+1NC	LRC6A52-20	⊕ 1NO+1NC
C7	LO	LRC7A34-20	1NO+1NC	LRC7A50-20	1NO+1NC	LRC7A51-20	⊕ 1NO+1NC	LRC7A52-20	⊕ 1NO+1NC
C9	L	LRC9A34-20	2NC	LRC9A50-20	2NC	LRC9A51-20	⊕ 2NC	LRC9A52-20	⊕ 2NC
C10	L	LRC10A34-20	2NO	LRC10A50-20	2NO	LRC10A51-20	2NO	LRC10A52-20	2NO
C11	R	LRC11A34-20	2NC	LRC11A50-20	2NC	LRC11A51-20	⊕ 2NC	LRC11A52-20	⊕ 2NC
C12	R	LRC12A34-20	2NO	LRC12A50-20	2NO	LRC12A51-20	2NO	LRC12A52-20	2NO
C13	LV	LRC13A34-20	2NC	LRC13A50-20	2NC	LRC13A51-20	⊕ 2NC	LRC13A52-20	⊕ 2NC
C14	LS	LRC14A34-20	2NC	LRC14A50-20	2NC	LRC14A51-20	⊕ 2NC	LRC14A52-20	⊕ 2NC
C15	LS	LRC15A34-20	2NO	LRC15A50-20	2NO	LRC15A51-20	2NO	LRC15A52-20	2NO
C16	LI	LRC16A34-20	2NC	LRC16A50-20	2NC	LRC16A51-20	⊕ 2NC	LRC16A52-20	⊕ 2NC
C18	LA	LRC18A34-20	1NO+1NC	LRC18A50-20	1NO+1NC	LRC18A51-20	⊕ 1NO+1NC	LRC18A52-20	⊕ 1NO+1NC
C20	L	LRC20A34-20	1NO+2NC	LRC20A50-20	1NO+2NC	LRC20A51-20	⊕ 1NO+2NC	LRC20A52-20	⊕ 1NO+2NC
C21	L	LRC21A34-20	3NC	LRC21A50-20	3NC	LRC21A51-20	⊕ 3NC	LRC21A52-20	⊕ 3NC
C22	L	LRC22A34-20	2NO+1NC	LRC22A50-20	2NO+1NC	LRC22A51-20	⊕ 2NO+1NC	LRC22A52-20	⊕ 2NO+1NC
C2	R	LRC2A34-20	2x(1NO-1NC)	LRC2A50-20	2x(1NO-1NC)	LRC2A51-20	2x(1NO-1NC)	LRC2A52-20	2x(1NO-1NC)
CE1		LRCE1A34-20	1NO-1NC	LRCE1A50-20	1NO-1NC	LRCE1A51-20	1NO-1NC	LRCE1A52-20	1NO-1NC
Max. speed		1.5 m/s		1.5 m/s		Type 1		Type 1	
Min. force		0.06 Nm		0.06 Nm		0.06 Nm (0.25 Nm ⊕)		0.06 Nm (0.25 Nm ⊕)	
Travel diagrams		Group 5		Group 5		Group 5		Group 5	

Contact blocks

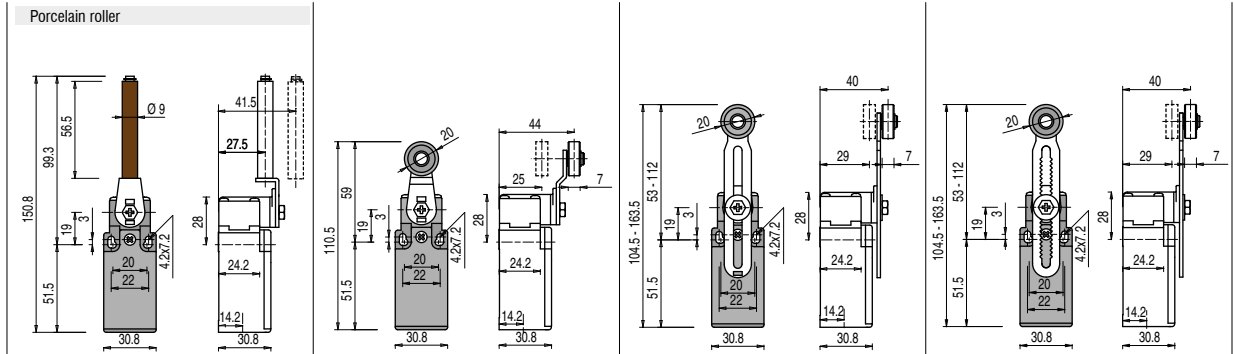

C5	R	LRC5A53-20	⊕ 1NO+1NC	LRC5A54-20	⊕ 1NO+1NC	LRC5A55-20	⊕ (*) 1NO+1NC	LRC5A56-20	⊕ 1NO+1NC
C6	L	LRC6A53-20	⊕ 1NO+1NC	LRC6A54-20	⊕ 1NO+1NC	LRC6A55-20	⊕ (*) 1NO+1NC	LRC6A56-20	⊕ 1NO+1NC
C7	LO	LRC7A53-20	⊕ 1NO+1NC	LRC7A54-20	⊕ 1NO+1NC	LRC7A55-20	⊕ (*) 1NO+1NC	LRC7A56-20	⊕ 1NO+1NC
C9	L	LRC9A53-20	⊕ 2NC	LRC9A54-20	⊕ 2NC	LRC9A55-20	⊕ (*) 2NC	LRC9A56-20	⊕ 2NC
C10	L	LRC10A53-20	2NO	LRC10A54-20	2NO	LRC10A55-20	2NO	LRC10A56-20	2NO
C11	R	LRC11A53-20	⊕ 2NC	LRC11A54-20	⊕ 2NC	LRC11A55-20	⊕ (*) 2NC	LRC11A56-20	⊕ 2NC
C12	R	LRC12A53-20	2NO	LRC12A54-20	2NO	LRC12A55-20	2NO	LRC12A56-20	2NO
C13	LV	LRC13A53-20	⊕ 2NC	LRC13A54-20	⊕ 2NC	LRC13A55-20	⊕ (*) 2NC	LRC13A56-20	⊕ 2NC
C14	LS	LRC14A53-20	⊕ 2NC	LRC14A54-20	⊕ 2NC	LRC14A55-20	⊕ (*) 2NC	LRC14A56-20	⊕ 2NC
C15	LS	LRC15A53-20	2NO	LRC15A54-20	2NO	LRC15A55-20	2NO	LRC15A56-20	2NO
C16	LI	LRC16A53-20	⊕ 2NC	LRC16A54-20	⊕ 2NC	LRC16A55-20	⊕ (*) 2NC	LRC16A56-20	⊕ 2NC
C18	LA	LRC18A53-20	⊕ 1NO+1NC	LRC18A54-20	⊕ 1NO+1NC	LRC18A55-20	⊕ (*) 1NO+1NC	LRC18A56-20	⊕ 1NO+1NC
C20	L	LRC20A53-20	⊕ 1NO+2NC	LRC20A54-20	⊕ 1NO+2NC	LRC20A55-20	⊕ (*) 1NO+2NC	LRC20A56-20	⊕ 1NO+2NC
C21	L	LRC21A53-20	⊕ 3NC	LRC21A54-20	⊕ 3NC	LRC21A55-20	⊕ (*) 3NC	LRC21A56-20	⊕ 3NC
C22	L	LRC22A53-20	⊕ 2NO+1NC	LRC22A54-20	⊕ 2NO+1NC	LRC22A55-20	⊕ (*) 2NO+1NC	LRC22A56-20	⊕ 2NO+1NC
C2	R	LRC2A53-20	2x(1NO-1NC)	LRC2A54-20	2x(1NO-1NC)	LRC2A55-20	2x(1NO-1NC)	LRC2A56-20	2x(1NO-1NC)
CE1		LRCE1A53-20	1NO-1NC	LRCE1A54-20	1NO-1NC	LRCE1A55-20	1NO-1NC	LRCE1A56-20	1NO-1NC
Max. speed		0.5 m/s		Type 1		Type 1		Type 1	
Min. force		0.03 Nm (0.25 Nm ⊕)		0.06 Nm (0.25 Nm ⊕)		0.06 Nm (0.25 Nm ⊕)		0.06 Nm (0.25 Nm ⊕)	
Travel diagrams		Group 6		Group 5		Group 5		Group 5	

(*) Positive opening only with actuator set to max.

All measures in the drawings are in mm

Contact type:

- R** = snap action
- L** = slow action
- LO** = slow action overlapped
- LS** = slow action shifted
- LV** = slow action shifted and spaced
- LI** = slow action independent
- LA** = slow action closer
- = electronic PNP

Contact blocks

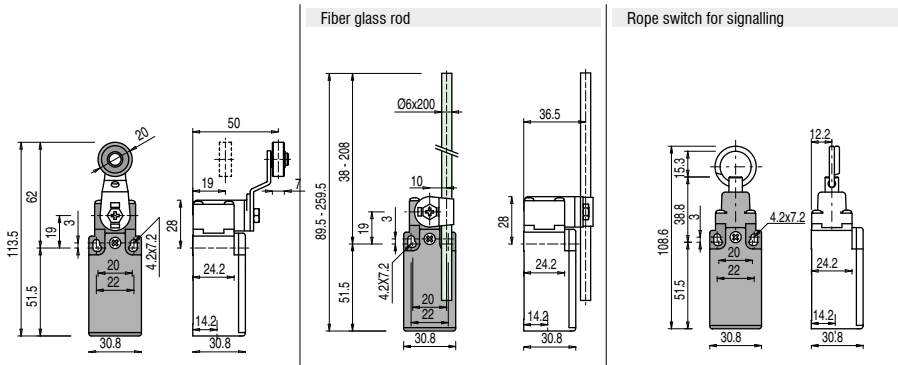

C5	R	LRC5A57-20	⊕ 1NO+1NC	LRC5A69-20	1NO+1NC	LRC5A76-20	1NO+1NC
C6	L	LRC6A57-20	⊕ 1NO+1NC	LRC6A69-20	1NO+1NC	LRC6A76-20	1NO+1NC
C7	LO	LRC7A57-20	⊕ 1NO+1NC	LRC7A69-20	1NO+1NC	LRC7A76-20	1NO+1NC
C9	L	LRC9A57-20	⊕ 2NC	LRC9A69-20	2NC	LRC9A76-20	2NO
C10	L	LRC10A57-20	2NO	LRC10A69-20	2NO	LRC10A76-20	2NC
C11	R	LRC11A57-20	⊕ 2NC	LRC11A69-20	2NC	LRC11A76-20	2NO
C12	R	LRC12A57-20	2NO	LRC12A69-20	2NO	LRC12A76-20	2NC
C13	LV	LRC13A57-20	⊕ 2NC	LRC13A69-20	2NC	LRC13A76-20	2NO
C14	LS	LRC14A57-20	⊕ 2NC	LRC14A69-20	2NC	LRC14A76-20	2NO
C15	LS	LRC15A57-20	2NO	LRC15A69-20	2NO	LRC15A76-20	2NC
C16	LI	LRC16A57-20	⊕ 2NC	LRC16A69-20	2NC		
C18	LA	LRC18A57-20	⊕ 1NO+1NC	LRC18A69-20	1NO+1NC	LRC18A76-20	1NO+1NC
C20	L	LRC20A57-20	⊕ 1NO+2NC	LRC20A69-20	1NO+2NC	LRC20A76-20	2NO+1NC
C21	L	LRC21A57-20	⊕ 3NC	LRC21A69-20	3NC	LRC21A76-20	3NO
C22	L	LRC22A57-20	⊕ 2NO+1NC	LRC22A69-20	2NO+1NC	LRC22A76-20	1NO+2NC
C2	R	LRC2A57-20	2x(1NO-1NC)	LRC2A69-20	2x(1NO-1NC)	LRC2A76-20	2x(1NO-1NC)
CE1		LRCE1A57-20	1NO-1NC	LRCE1A69-20	1NO-1NC		
Max. speed		Type 1		1.5 m/s		0.5 m/s	
Min. force		0.06 Nm (0.25 Nm ⊕)		0.06 Nm		initial 20 N - final 40 N	
Travel diagrams		Group 5		Group 5		Group 7	

Position switches LR series with reset



IMO Precision Controls has developed a range of position switches that incorporate a Reset device. This is denoted by the addition of the suffix R to the part numbers. The Reset device is a block inserted between the switch body and the head, and it can be rotated and positioned in four locations independent to the head. Some of the features of the Reset device are as follows:

- Easy integration in to almost all standard heads
- No need to use snap action contact blocks as the tripping movement is defined by the Reset device
- Rotation for ease of installation
- Two driving forces are available - standard and increased for use in applications where vibration is present
- Mechanical endurance - up to 1 million operating cycles.

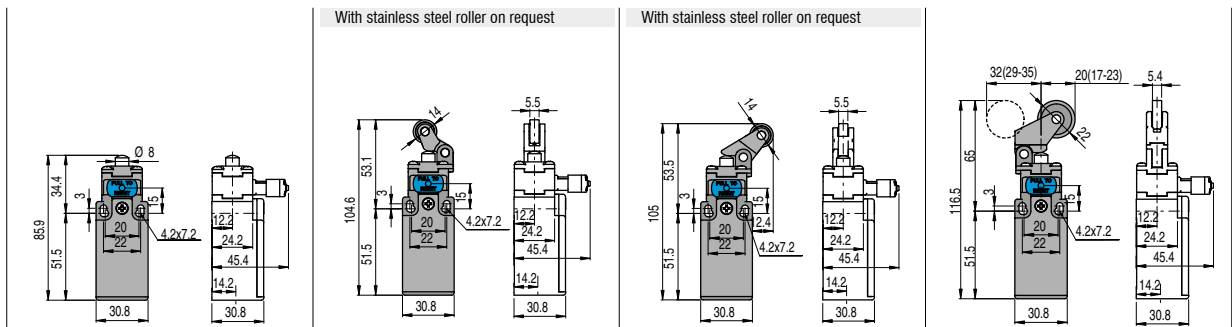

Contact blocks

C6	L	LRC6A01-R20	⊕ 1NO+1NC	LRC6A02-R20	⊕ 1NO+1NC	LRC6A05-R20	⊕ 1NO+1NC	LRC6A07-R20	⊕ 1NO+1NC
C9	L	LRC9A01-R20	⊕ 2NC	LRC9A02-R20	⊕ 2NC	LRC9A05-R20	⊕ 2NC	LRC9A07-R20	⊕ 2NC
C10	L	LRC10A01-R20	2NO	LRC10A02-R20	2NO	LRC10A05-R20	2NO	LRC10A07-R20	2NO
C20	L	LRC20A01-R20	⊕ 1NO+2NC	LRC20A02-R20	⊕ 1NO+2NC	LRC20A05-R20	⊕ 1NO+2NC	LRC20A07-R20	⊕ 1NO+2NC
C21	L	LRC21A01-R20	⊕ 3NC	LRC21A02-R20	⊕ 3NC	LRC21A05-R20	⊕ 3NC	LRC21A07-R20	⊕ 3NC
C22	L	LRC22A01-R20	⊕ 2NO+1NC	LRC22A02-R20	⊕ 2NO+1NC	LRC22A05-R20	⊕ 2NO+1NC	LRC22A07-R20	⊕ 2NO+1NC
C2	R	LRC2A01-R20	2NO+2NC	LRC2A02-R20	2NO+2NC	LRC2A05-R20	2NO+2NC	LRC2A07-R20	2NO+2NC
Max. speed		Type 4		Type 3		Type 3		Type 3	
Min. force		4.5 N (25 N ⊕)		4 N (25 N ⊕)		4 N (25 N ⊕)		2.5 N (25 N ⊕)	
Travel diagrams		Group 1		Group 2		Group 2		Group 3	

All measures in the drawings are in mm

Contact type:

- R** = snap action
- L** = slow action

With Ø 12 mm stainless steel roller on request

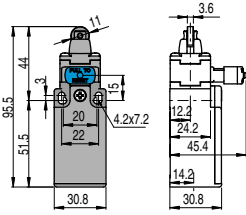

With Ø 20 mm stainless steel roller on request

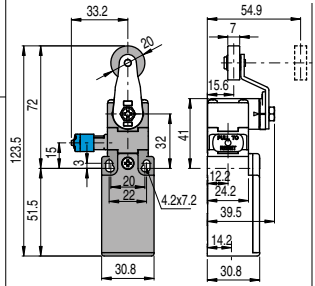
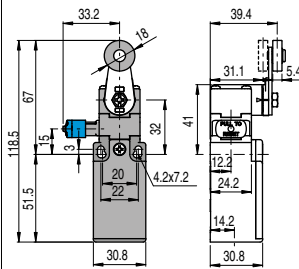
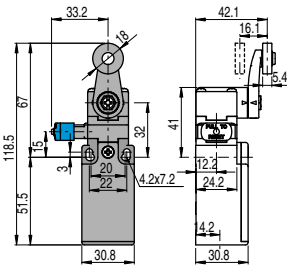

Contact blocks

C6	<input type="checkbox"/> L				
C9	<input type="checkbox"/> L	LRC9A15-R20	⊖ 2NC	LRC9A30-R20	⊕ 2NC
C10	<input type="checkbox"/> L				
C20	<input type="checkbox"/> L	LRC20A15-R20	⊖ 1NO+2NC	LRC20A30-R20	⊕ 1NO+2NC
C21	<input type="checkbox"/> L				
C22	<input type="checkbox"/> L	LRC22A15-R20	⊖ 2NO+1NC	LRC22A30-R20	⊕ 2NO+1NC
C2	<input type="checkbox"/> R				
Max. speed		Type 2		Type 1	
Min. force		4.5 N (25 N ⊕)		0.07 Nm (0.25 Nm ⊖)	
Travel diagrams		Group 1		Group 4	

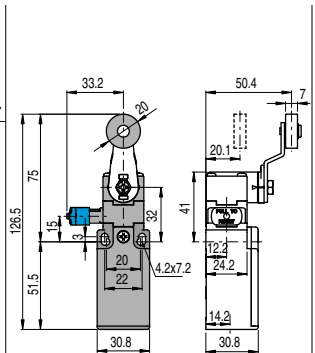
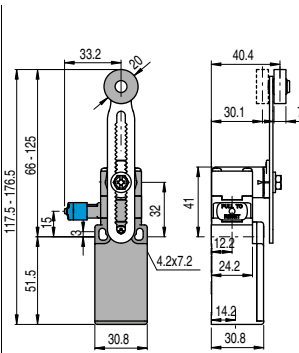
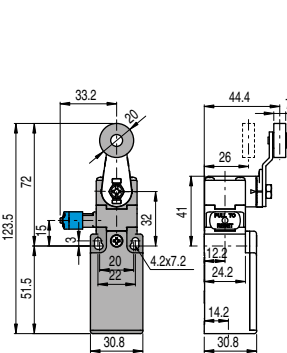
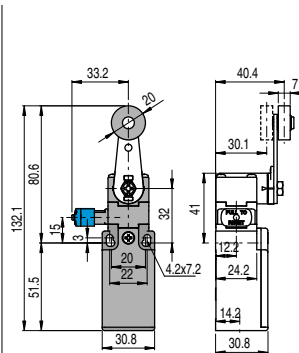

Contact blocks

C6	<input type="checkbox"/> L				
C9	<input type="checkbox"/> L	LRC9A52-R20	⊖ 2NC	LRC9A54-R20	⊕ 2NC
C10	<input type="checkbox"/> L				
C20	<input type="checkbox"/> L	LRC20A52-R20	⊖ 1NO+2NC	LRC20A54-R20	⊕ 1NO+2NC
C21	<input type="checkbox"/> L				
C22	<input type="checkbox"/> L	LRC22A52-R20	⊖ 2NO+1NC	LRC22A54-R20	⊕ 2NO+1NC
C2	<input type="checkbox"/> R				
Max. speed		Type 1		Type 1	
Min. force		0.07 Nm (0.25 Nm ⊕)		0.07 Nm (0.25 Nm ⊕)	
Travel diagrams		Group 4		Group 4	

All measures in the drawings are in mm

Increased actuating force

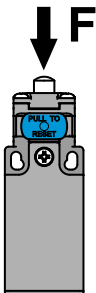

The switch can be delivered with increased actuating force (option RI). Ideal for applications with vibrations.

Actuators	Min. force
01, 14, 15, 16	7 N
02, 05	6 N
07	3.5 N
30 ... 57	0.08 Nm

Position switches with revolving lever without actuator

Contact type:

- R** = snap action
- L** = slow action
- LO** = slow action overlapped
- LS** = slow action shifted
- LV** = slow action shifted and spaced
- LI** = slow action independent
- LA** = slow action closer
- PNP** = electronic PNP

Contact blocks

			With manual reset knob
C5	R	LRC5A38-20	➔ 1NO+1NC
C6	L	LRC6A38-20	➔ 1NO+1NC
C7	LO	LRC7A38-20	➔ 1NO+1NC
C9	L	LRC9A38-20	➔ 2NC
C10	L	LRC10A38-20	2NO
C11	R	LRC11A38-20	➔ 2NC
C12	R	LRC12A38-20	2NO
C13	LV	LRC13A38-20	➔ 2NC
C14	LS	LRC14A38-20	➔ 2NC
C15	LS	LRC15A38-20	2NO
C16	LI	LRC16A38-20	➔ 2NC
C18	LA	LRC18A38-20	➔ 1NO+1NC
C20	L	LRC20A38-20	➔ 1NO+2NC
C21	L	LRC21A38-20	➔ 3NC
C22	L	LRC22A38-20	➔ 2NO+1NC
C2	R	LRC2A38-20	2x(1NO-1NC)
CE1	PNP	LRCE1A38-20	1NO-1NC
Min. force		0.06 Nm (0.25 Nm ➔)	0.07 Nm (0.25 Nm ➔)
Travel diagrams		Group 5	Group 4

Dimensions (mm):

IMPORTANT
For safety applications: join only switches and actuators marked with symbol aside the product code.

All measures in the drawings are in mm

All measures in the drawings are in mm

Loose actuators

All measures in the drawings are in mm

IMPORTANT: These loose actuators can be used with items of series LR, LM, LX, LZ and LK only.

Technopolymer roller Ø 18 mm	Technopolymer roller Ø 18 mm	Adjustable square rod, 3x3x125 mm	Flexible rod with pointed end	Adjustable round rod Ø 3x125 mm	Technopolymer roller Ø 20 mm	
AC-CAE30 ➔	AC-CAE31 ➔	AC-CAE33	AC-CAE34	AC-CAE50	AC-CAE51 ➔	
Technopolymer roller Ø 20 mm	Porcelain roller	Technopolymer roller Ø 20 mm	Adjustable actuator with technopolymer roller	Adjustable safety actuator with technopolymer roller	Technopolymer roller Ø 20 mm	Adjustable fiber glass rod
AC-CAE52 ➔	AC-CAE53 ➔ ⁽²⁾	CA-CAE54 ➔	AC-CAE55 ➔ ⁽¹⁾	AC-CAE56 ➔	AC-CAE57 ➔	AC-CAE69

- ⁽¹⁾ Actuator AC-CAE55 can only be used in safety applications if adjusted to its max. length, as shown in figure beside. If you need an adjustable lever for safety applications, use the adjustable safety lever AC-CAE56.
- ⁽²⁾ The position switch obtained by assembling switch LM • A38-20 (e.g. LMC5A38-20, LMC6A38-20...) with actuator AC-CAE53 will not present the same travel diagrams and actuating forces as switch LM • A53-JOST (e.g. LMC5A53-JOST, LMC6A53-JOST...).
- ⁽⁴⁾ The actuator cannot be rotated to the inside because it will mechanically interfere with the switch head.

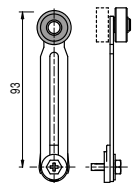

Special loose actuators

All measures in the drawings are in mm

IMPORTANT: These loose actuators can be used with items of series LR, LM, LX, LZ and LK only.

Stainless steel rollers, Ø 20 mm

AC-CAE31-R24 (1)	AC-CAE51-R24 (1)	AC-CAE52-R24 (1)	AC-CAE54-R24 (1)	AC-CAE55-R24 (1) (1)	AC-CAE56-R24 (1)	AC-CAE57-R24 (1)

Technopolymer rollers, Ø 35 mm

AC-CAE31-R25 (4)	AC-CAE51-R25 (4)	AC-CAE52-R25 (4)	AC-CAE54-R25 (4)	AC-CAE55-R25 (1) (1)	AC-CAE56-R25 (1)	AC-CAE57-R25 (1)

Rubber rollers, Ø 40 mm

AC-CAE31-R5 (4)	AC-CAE51-R5 (4)	AC-CAE52-R5 (4)	AC-CAE54-R5 (4)	AC-CAE55-R5 (1) (1)	AC-CAE56-R5 (1)	AC-CAE57-R5 (4)

Rubber rollers, Ø 50 mm

AC-CAE51-R26 (4)	AC-CAE2-R26 (4)	AC-CAE54-R26 (4)	AC-CAE55-R26 (1) (1)	AC-CAE56-R26 (1)	AC-CAE57-R26 (4)

Protruding rubber rollers, Ø 50 mm

AC-CAE55-R27 (1) (1)	AC-CAE56-R27 (1)

Maximum and minimum actuation speed

Lever with roller - Type 1

Ø	Vmax (m/s)	Vmin (mm/s)	
		L	R
15°	2.5	9	0.07
30°	1.5	8	
45°	1	7	
60°	0.75	7	

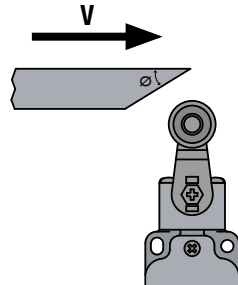

Plunger with roller - Type 2

Ø	Vmax (m/s)	Vmin (mm/s)	
		L	R
15°	1	4	0.04
30°	0.5	2	0.02
45°	0.3	1	0.01

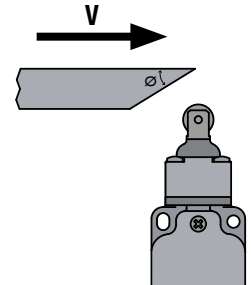

Lever with roller - Type 3

Ø	Vmax (m/s)	Vmin (mm/s)	
		L	R
15°	1	5	0.05
30°	0.5	2.5	0.025
45°	0.3	1.5	0.015

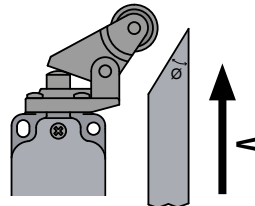

Plunger with roller - Type 5

Ø	Vmax (m/s)	Vmin (mm/s)	
		L	R
15°	0.3	4	0.04
30°	0.2	2	0.02

Plunger with roller - Type 4

Vmax (m/s)	Vmin (mm/s)	
	L	R
0.5	1	0.01

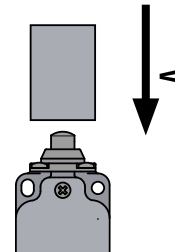

Contacts Type:

- R = snap action
- L = slow action

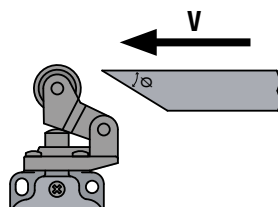

Driving Torques For LR and LX series only

- | | | |
|---|--|--|
| 1 | Cover screws | 0.8...1.2Nm |
| 2 | Head screws | 0.8...1.2Nm |
| 3 | Lever screws | 0.8...1.2Nm |
| 4 | Protection plugs | 1.2...1.6Nm
(conduit entry M20/PG13.5)
1.0...1.4Nm
(conduit entry M16/PG11) |
| 5 | Contact block screws | 0.6...0.8Nm |
| 6 | M5 screws of the housing fastening with washer | 2.0...3.0Nm |

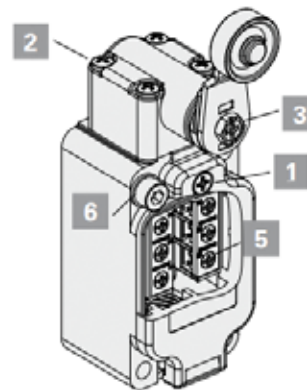

Travel Diagrams

Contact block		Group 1	Group 2	Group 3	Group 4
6 1NO+1NC					
9 2NC					
10 2NO					
20 1NO+2NC					
21 3NC					
22 2NO+1NC					
33 1NO+1NC					
34 2NC					
2 2x(1NO-1NC)					

Legend

Closed contact |
 Opened contact |
 Positive opening travel |
 Pushing the switch /
 Releasing the switch

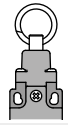
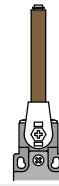
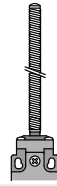

Contact block	Group 1	Group 2	Group 3	Group 4	Group 5	Group 6	Group 7 inverted contacts
2 2x(1NO-1NC)							
3 1NO-1NC							
5 1NO+1NC							
6 1NO+1NC				/			
7 1NO+1NC				/			
9 2NC				/			
10 2NO							
11 2NC				/		/	
12 2NO							
13 2NC				/			
14 2NC				/			
15 2NO				/			
16 2NC	/	/	/	/		/	/
18 1NO+1NC							
20 1NO+2NC							
21 3NC							
22 2NO+1NC							
28 1NO+2NC				/			
29 3NC				/			
30 3NC				/			
33 1NO+1NC							
34 2NC							
37 1NO+1NC				/			
66 1NC							
67 1NO							

Legend
 Closed contact | Opened contact | Positive opening travel | Pushing the switch / Releasing the switch

X-ON Electronics

Largest Supplier of Electrical and Electronic Components

Click to view similar products for [IMO manufacturer](#):

Other Similar products are found below :

[MB12-S-1024](#) [MB09-S-10230](#) [CS20A-A2](#) [SRKE-1AT-SL-24VDC](#) [SRF-1C-SL-12VDC](#) [MB09-S-1024](#) [HYE41PN120AC](#) [HYE41PN240AC](#)
[LDC18RRS](#) [LRC5A01](#) [IV07E-SECP](#) [SFSYE0111](#) [20.3304M/2-E](#) [21.95MHF/3-E](#) [MC24-S-00230](#) [MC18N-S-10230AC](#) [H69-0001](#) [CS20A-](#)
[U1](#) [CS20A-U4](#) [VFC02](#) [20.95MHF/3-E](#) [MC14N-S-10110AC](#) [E69-0003](#) [DPS-1-060-24](#) [BS3P3REDO](#) [DPS-1-030-24](#) [ISOCON-6](#) [20.1550M/2](#)
[FA4515-2DN](#) [U1216E4-MC](#) [MA05-S-0040110AC](#) [MA05-S-0040230AC](#) [20.950MF/5-E](#) [20.4101M/4-P](#) [BS3P34REDO](#) [21.95MH/12-E](#)
[20.920M/5-E](#) [FA4501-2DN](#) [MC10N-S-10230AC](#) [MC10N-S-10110AC](#) [DPS-1-120-24](#) [CS20A-A3](#) [20.95MH/3-E](#) [21.95MV/3](#) [MA05-S-](#)
[01230AC](#) [SRRHN-2CN-SL-5VDC](#) [LB69-4040](#) [20.3001M/6](#) [UFSRE0101](#) [MA05-R-S-10230AC](#)