

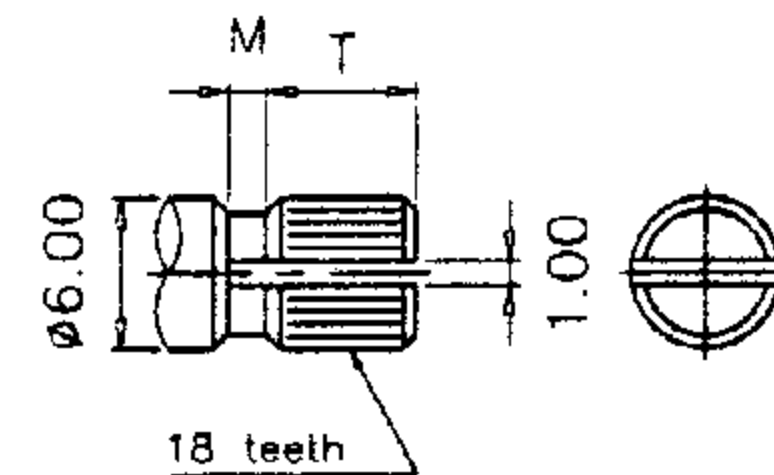

shaft shown in full  
c.c.w. position

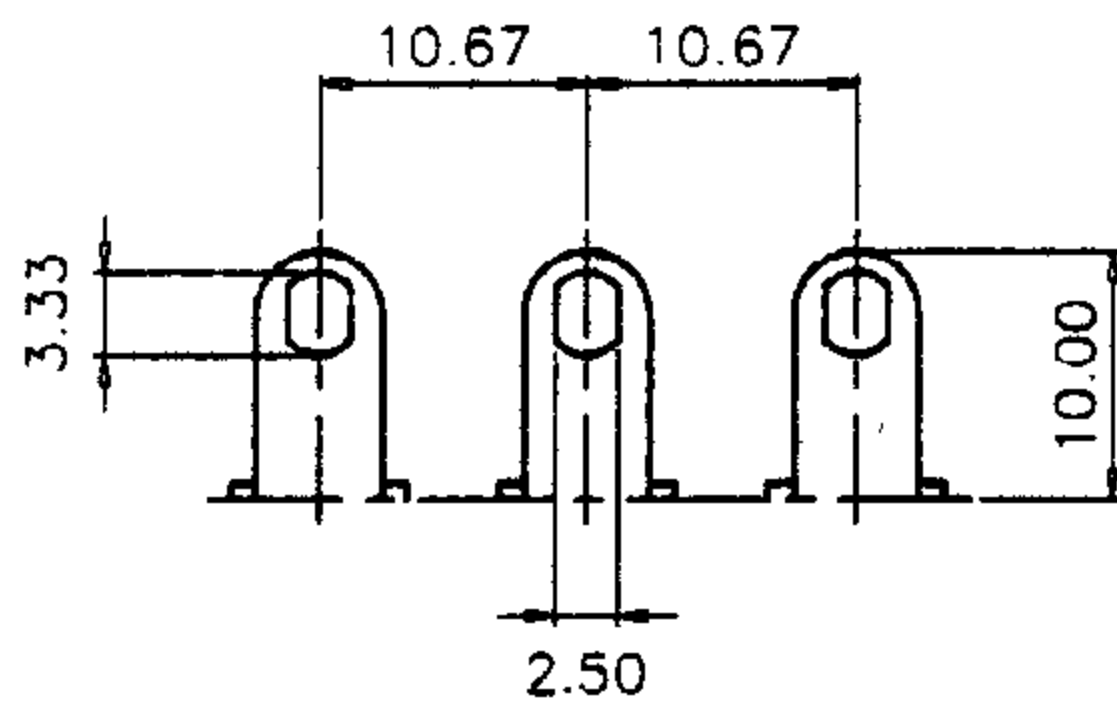

KQ TYPE:

X	4
L	25
T	12.1
M	2

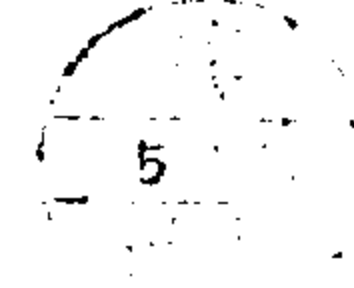
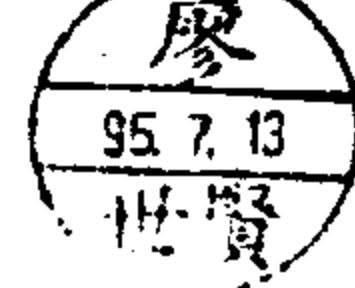
3			NAME	28-0678 5K	
2				DRAWING NO	
1			DRAWN BY		CHECK BY
NO	DATE	DESCRIPTION			
TOLERANCE		SCALE			
less than 10±0.3		2/1 6/5			
above 10-30±0.5		DIMENSION			
above 30-100±1.0		m/m			

(VRA4)

1.RESISTANCE TAPER -----	Linear Taper
2.TOTAL RESISTANCE -----	5KΩ
3.TOTAL RESISTANCE TOLERANCE-----	±20%
4.RATED POWER -----	curve B:0.5W
5.MAX. OPERATING VOLTAGE -----	curve B:500V
6.SLIDING/ROTATIONAL NOISE -----	less than 100mV
7.INSULATION RESISTANCE -----	more than 100MΩ at DC 500V
8.RESIDUAL RESISTANCE -----	10KΩ ≥ R 10Ω MAX. 250KΩ > R > 10KΩ 20Ω MAX. R ≥ 250KΩ 0.1% MAX. of total resistance
9.WITHSTAND VOLTAGE -----	1 minute at AC 500V

**MECHANICAL SPECIFICATION**

1.TOTAL SLIDING/ROTATION ANGLE -----	300° ±5°
2.OPERATING TORQUE FORCE -----	20 ~ 200 gf.cm
3.SHAFT LEVER STRENGTH-----	PULL-PUSH 8 kgf MAX.
4.SHAFT LEVER WOBBLE -----	without bushing 0.7*L/20mm p-p MAX. with bushing 0.7*L/30mm p-p MAX.
5.SLIDE/ROTATION STOP STRENGTH-----	7 kgf.cm
6.CLICK POSITION -----	center/11/21/31/41 detent
7.CLICK TORQUE -----	rotation torque +30 ~ 300 gf.cm
8.NUT TIGHTENING STRENGTH -----	12 kgf.cm MAX.

**DURABILITY**

1.SLIDING/ROTATIONAL LIFE -----	10,000 cycles
2.SWITCH LIFE -----	

NOTE:

PREPARED BY      REVIEWED BY      APPROVED BY



## X-ON Electronics

Largest Supplier of Electrical and Electronic Components

*Click to view similar products for [MCM manufacturer](#):*

Other Similar products are found below :

[NWTBATCAPMB13](#) [25-020](#) [27-505](#) [27-4155](#) [27-840](#) [28-0755](#) [28-5958](#) [50-10820](#) [37-330](#) [PI-UPTIMEUPS](#) [27-5918](#) [27-5977](#) [12-3410](#) [28-6023](#) [55-3230](#) [35SPS-3](#) [28-6008](#) [22-26180](#) [17705](#) [55-5675](#) [27-6020](#) [24-12352](#) [21-7655](#) [28-6017](#) [53-1230](#) [28-5965](#) [21-18966](#) [22-1640](#) [27-4200](#) [83-17607](#) [27-5833](#) [27-5925](#) [24-12344](#) [12-3404](#) [PCM-2100-50](#) [21-19004](#) [28-6080](#) [22-665](#) [24-1040](#) [27-5917](#) [28-6005](#) [55-5670](#)  
[HD15MM35N-100F](#) [21-4605](#) [21-12825](#) [24-5360](#) [27-4270](#) [27-5940](#) [27-5949](#) [27-6112](#)