

SRA3

solid-state relay - three phase

DURAKOOL

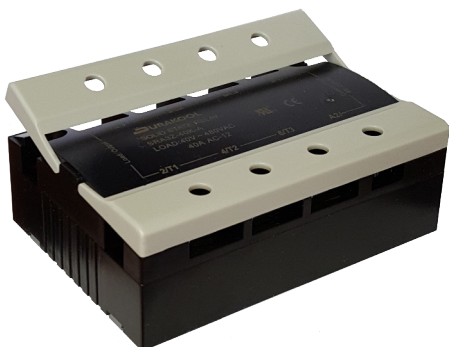

- High load voltage - up to 480VAC
- 4 - 32VDC or 90 - 250VAC control voltage
- Zero cross-over or Random switching
- LED input indicator
- Finger protected terminals
- RoHS Compliant



Output (load)

Load type		3PST-NO (3 N/O) Resistive
Load current		10A, 20A, 25A, 30A, 40A, 60A, or 80A
Load switching voltage	AC V _{rms}	24 - 240V, 40 - 480V
Maximum peak voltage	AC V _{pk}	900V
Switch type		Zero Cross (std) or Random
On voltage drop	V AC	1.5V
Leakage current (off state)	mA	≤ 7mA

Input (control)

Control voltage	V	D: 4 - 32VDC or A: 90 - 250VAC
Control current	mA	< 20mA
Turn-on voltage	V _{min}	D: 3VDC / A: 90VAC
Turn-off voltage	V	D: 1VDC / A: 10VAC

Insulation

Insulation resistance		≤ 500MΩ at 500VDC, 50%RH
Dielectric strength	V AC	≥ 2500V

General Data

Operating time	ms	approx 1/2 cycle of load frequency + ≤1ms (zero x-over)
Release time	ms	approx 1/2 cycle of load frequency + ≤1ms (zero x-over)
Dimensions	L x W x H	106 x 75 x 38mm
Weight		various 365g 10A ~ 500g 80A
Ambient temperature	storage	-30 to 80°C
	operating	-30 to 80°C (with derating). A heat sink may be required.

SRA3

solid-state relay - three phase



Ordering Code

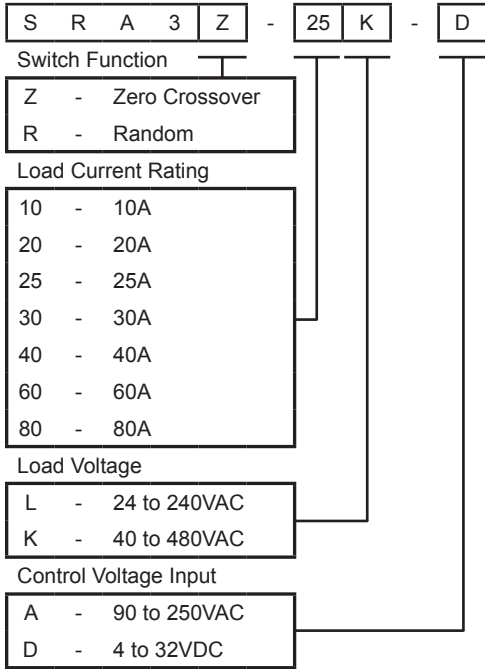

Dimensions

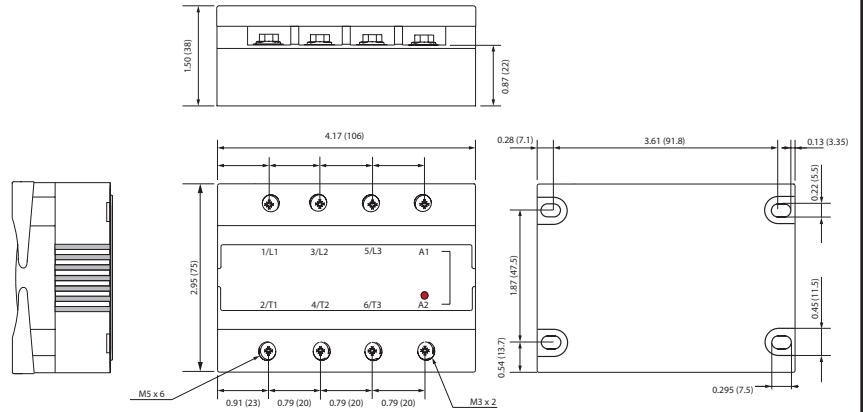

Dimensions in inches (mm)

Fig.2

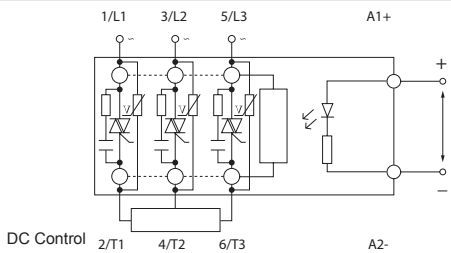

Fig.3

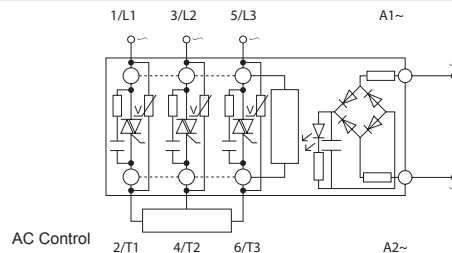
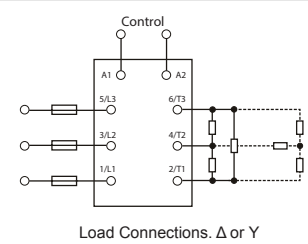

Fig.4



Load Connections. Δ or Y

Table 1

Fig. 5

SSR Series	SRA3*-10*.*	SRA3*-25*.*	SRA3*-40*.*	SRA3*-60*.*
	SRA3*-20*.*	SRA3*-30*.*		SRA3*-80*.*
Current rating	≤ 20A	≤ 30A	≤ 40A	≤ 80A
Heat Sink	DHS05	DHS06	DHS07	DHS08 (or DHS09)
Heat Sink Rating °C/W	0.93	0.65	0.48	0.44 (0.39)

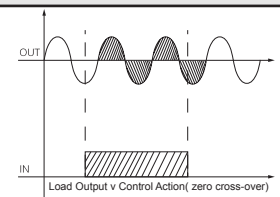
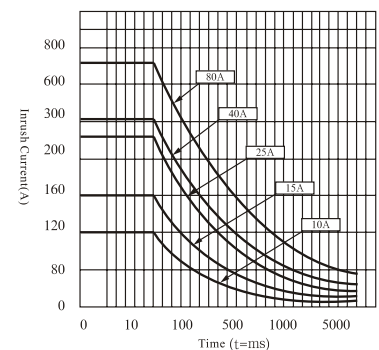
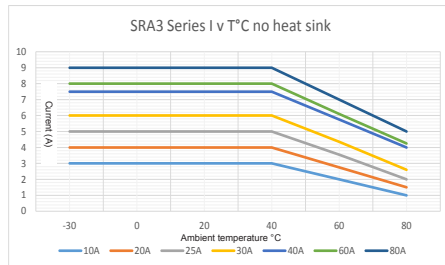
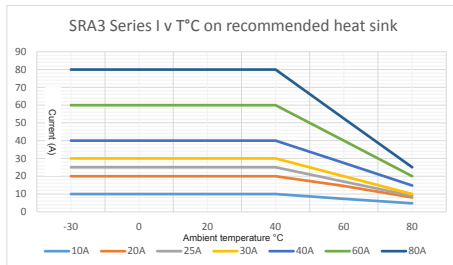

Fig.6

Fig.7

Fig.8



SRA3

solid-state relay - three phase



Heat Sinks

DHS05

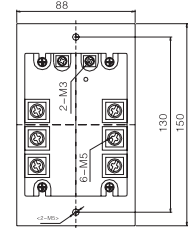
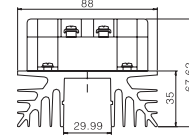
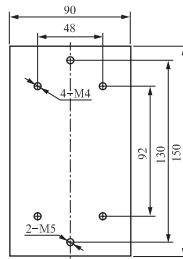
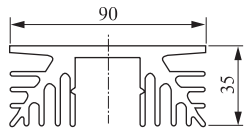
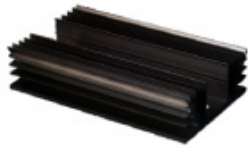

DHS06

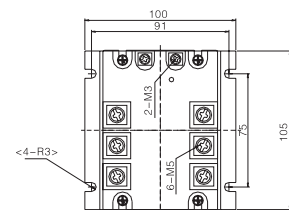
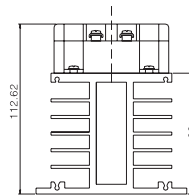
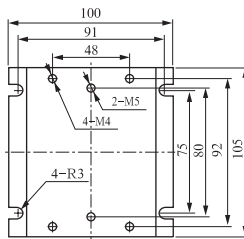
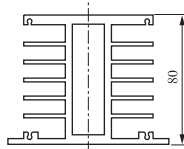

DHS07

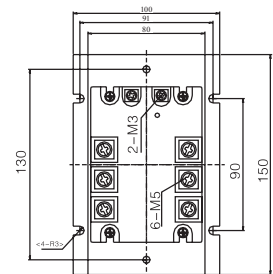
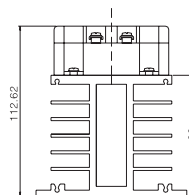
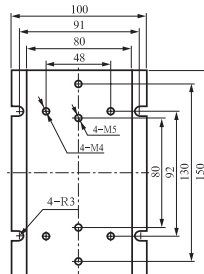
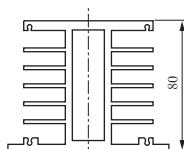

DHS08

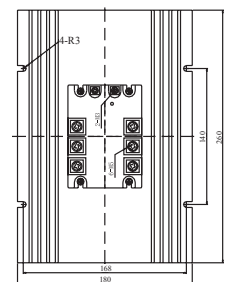
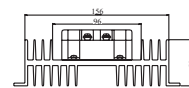
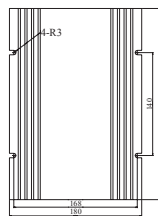
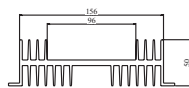

DHS09

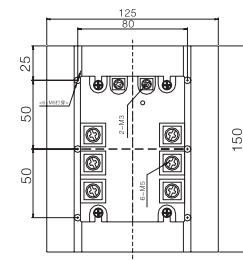
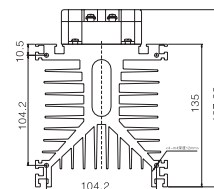
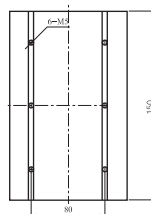
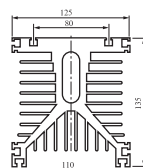

X-ON Electronics

Largest Supplier of Electrical and Electronic Components

Click to view similar products for [Durakool](#) manufacturer:

Other Similar products are found below :

[DG85B-8011-35-1012](#) [SDA3Z-30K-A](#) [4859](#) [DFC3-301](#) [DM84-2012-35-1012](#) [SDA1Z-40K-D](#) [DM85-2011-35-1012](#) [SRA3Z-60K-D](#) [DHS01](#)
[SDA1Z-15K-D](#) [SDA1Z-80K-A](#) [SDA1Z-80K-D](#) [SRA1Z-25K-D](#) [SDA3Z-30K-D](#) [DM84-2012-35-5012](#) [SRA3Z-80K-D](#) [DHS02](#) [SRA1Z-10K-](#)
[D](#) [SRA3Z-60K-A](#) [SRA1Z-40K-D](#) [A1/2-001](#) [SRA1Z-60K-A](#) [SRA1Z-40K-A](#) [SIM212-12VDC](#) [SRA1Z-10K-A](#) [A1B-003](#) [DG85B-](#)
[8021-96-1012-M1](#) [DM84-2012-35-1024](#) [DG85C-8021-75-1012](#) [SRA1Z-25K-A](#) [DG20-8011-35-1012](#) [SRA1Z-60K-D](#) [SRA1Z-100K-A](#) [5002](#)
[SRA2Z-40K-D](#) [SRA1Z-40L-A](#) [SRD-SGR2-M03](#) [DG85CM-5021-76-1012](#) [SRA1Z-15L-D](#) [DG85B-8011-96-1012-M1](#) [SIM112](#) [16VDC](#)
[SRA1Z-80K-A](#) [SRA1Z-25L-A](#) [DTP1](#) [SRA1Z-100K-D](#) [SRA1Z-15L-A](#) [SRA1Z-100L-D](#) [SRA1Z-25L-D](#) [SRA1Z-40L-D](#) [SRA1Z-60L-A](#)