



RF Power LDMOS Transistor

N-Channel Enhancement-Mode Lateral MOSFET

This 45 watt asymmetrical Doherty RF power LDMOS transistor is designed for cellular base station applications requiring very wide instantaneous bandwidth capability covering the frequency range of 2496 to 2690 MHz.

- Typical Doherty Single-Carrier W-CDMA Performance: $V_{DD} = 28$ Volts, $I_{DQA} = 500$ mA, $V_{GSB} = 0.3$ Vdc, $P_{out} = 45$ Watts Avg., Input Signal PAR = 9.9 dB @ 0.01% Probability on CCDF.

Frequency	G_{ps} (dB)	η_D (%)	Output PAR (dB)	ACPR (dBc)
2496 MHz	14.1	45.2	7.8	-31.1
2590 MHz	14.2	44.0	7.8	-35.6
2690 MHz	13.9	44.1	7.6	-37.5

Features

- Advanced High Performance In-Package Doherty
- Designed for Wide Instantaneous Bandwidth Applications
- Greater Negative Gate-Source Voltage Range for Improved Class C Operation
- Designed for Digital Predistortion Error Correction Systems
- In Tape and Reel. R6 Suffix = 150 Units, 56 mm Tape Width, 13-inch Reel.

AFT26H200W03SR6

2496-2690 MHz, 45 W AVG., 28 V AIRFAST RF POWER LDMOS TRANSISTOR

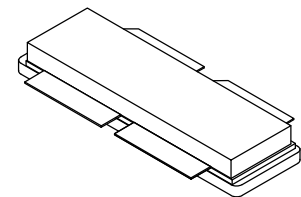

NI-1230S-4S

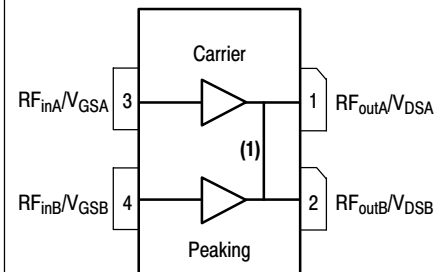

(Top View)

Figure 1. Pin Connections

1. Pin connections 1 and 2 are DC coupled and RF independent.

Table 1. Maximum Ratings

Rating	Symbol	Value	Unit
Drain–Source Voltage	V_{DSS}	–0.5, +65	Vdc
Gate–Source Voltage	V_{GS}	–6.0, +10	Vdc
Operating Voltage	V_{DD}	32, +0	Vdc
Storage Temperature Range	T_{stg}	–65 to +150	°C
Case Operating Temperature Range	T_C	–40 to +125	°C
Operating Junction Temperature Range (1,2)	T_J	–40 to +225	°C

Table 2. Thermal Characteristics

Characteristic	Symbol	Value (2,3)	Unit
Thermal Resistance, Junction to Case Case Temperature 76°C, 45 W–CDMA, 28 Vdc, $I_{DQA} = 500$ mA, $V_{GSB} = 0.3$ Vdc, 2590 MHz	$R_{\theta JC}$	0.46	°C/W

Table 3. ESD Protection Characteristics

Test Methodology	Class
Human Body Model (per JESD22–A114)	2
Machine Model (per EIA/JESD22–A115)	B
Charge Device Model (per JESD22–C101)	III

Table 4. Electrical Characteristics ($T_A = 25^\circ\text{C}$ unless otherwise noted)

Characteristic	Symbol	Min	Typ	Max	Unit
----------------	--------	-----	-----	-----	------

Off Characteristics (4)

Zero Gate Voltage Drain Leakage Current (5) ($V_{DS} = 65$ Vdc, $V_{GS} = 0$ Vdc)	I_{DSS}	—	—	10	μAdc
Zero Gate Voltage Drain Leakage Current (5) ($V_{DS} = 28$ Vdc, $V_{GS} = 0$ Vdc)	I_{DSS}	—	—	5	μAdc
Gate–Source Leakage Current (6) ($V_{GS} = 5$ Vdc, $V_{DS} = 0$ Vdc)	I_{GSS}	—	—	1	μAdc

On Characteristics – Side A (4,6) (Carrier)

Gate Threshold Voltage ($V_{DS} = 10$ Vdc, $I_D = 100$ μAdc)	$V_{GS(th)}$	0.8	1.2	1.6	Vdc
Gate Quiescent Voltage ($V_{DD} = 28$ Vdc, $I_{DA} = 500$ mAdc, Measured in Functional Test)	$V_{GS(Q)}$	1.4	1.8	2.2	Vdc
Drain–Source On–Voltage ($V_{GS} = 6$ Vdc, $I_D = 1.0$ Adc)	$V_{DS(on)}$	0.1	0.15	0.3	Vdc

On Characteristics – Side B (4,6) (Peaking)

Gate Threshold Voltage ($V_{DS} = 10$ Vdc, $I_D = 180$ μAdc)	$V_{GS(th)}$	0.8	1.2	1.6	Vdc
Drain–Source On–Voltage ($V_{GS} = 6$ Vdc, $I_D = 1.8$ Adc)	$V_{DS(on)}$	0.1	0.15	0.3	Vdc

1. Continuous use at maximum temperature will affect MTTF.
2. MTTF calculator available at <http://www.freescale.com/rf>. Select Software & Tools/Development Tools/Calculators to access MTTF calculators by product.
3. Refer to AN1955, *Thermal Measurement Methodology of RF Power Amplifiers*. Go to <http://www.freescale.com/rf>. Select Documentation/Application Notes – AN1955.
4. V_{DDA} and V_{ddb} must be tied together and powered by a single DC power supply.
5. Side A and Side B are tied together for these measurements.
6. Each side of device measure separately.

Table 4. Electrical Characteristics ($T_A = 25^\circ\text{C}$ unless otherwise noted) (continued)

Characteristic	Symbol	Min	Typ	Max	Unit
Functional Tests (1,2,3) (In Freescale Doherty Test Fixture, 50 ohm system) $V_{DD} = 28\text{ Vdc}$, $I_{DQA} = 500\text{ mA}$, $V_{GSB} = 0.3\text{ Vdc}$, $P_{out} = 45\text{ W Avg.}$, $f = 2496\text{ MHz}$, Single-Carrier W-CDMA, IQ Magnitude Clipping, Input Signal PAR = 9.9 dB @ 0.01% Probability on CCDF. ACPR measured in 3.84 MHz Channel Bandwidth @ $\pm 5\text{ MHz}$ Offset.					
Power Gain	G_{ps}	13.0	14.1	16.0	dB
Drain Efficiency	η_D	42.0	45.2	—	%
Output Peak-to-Average Ratio @ 0.01% Probability on CCDF	PAR	7.5	7.8	—	dB
Adjacent Channel Power Ratio	ACPR	—	-31.1	-28.0	dBc

Load Mismatch (In Freescale Test Fixture, 50 ohm system) $I_{DQA} = 500\text{ mA}$, $V_{GSB} = 0.3\text{ Vdc}$, $f = 2590\text{ MHz}$, 10 μsec Pulse Width, 10% Duty Cycle, <100 ns Input Rise Time

VSWR 10:1 at 30 Vdc, 280 W Pulse Output Power (3 dB Input Overdrive from 250 W Pulse Rated Power)	No Device Degradation
--	-----------------------

Typical Performances (3) (In Freescale Doherty Test Fixture, 50 ohm system) $V_{DD} = 28\text{ Vdc}$, $I_{DQA} = 500\text{ mA}$, $V_{GSB} = 0.3\text{ Vdc}$, 2496–2690 MHz Bandwidth

P_{out} @ 1 dB Compression Point, CW	P1dB	—	200	—	W
P_{out} @ 3 dB Compression Point (4)	P3dB	—	280	—	W
AM/PM (Maximum value measured at the P3dB compression point across the 2496–2690 MHz frequency range)	Φ	—	-13	—	$^\circ$
VBW Resonance Point (IMD Third Order Intermodulation Inflection Point)	VBW_{res}	—	220	—	MHz
Gain Flatness in 194 MHz Bandwidth @ $P_{out} = 45\text{ W Avg.}$	G_F	—	0.3	—	dB
Gain Variation over Temperature (-30°C to +85°C)	ΔG	—	0.019	—	dB/°C
Output Power Variation over Temperature (-30°C to +85°C)	$\Delta P1dB$	—	0.0377	—	dB/°C

1. V_{DDA} and V_{ddb} must be tied together and powered by a single DC power supply.
2. Part internally matched both on input and output.
3. Measurements made with device in an asymmetrical Doherty configuration.
4. $P3dB = P_{avg} + 7.0\text{ dB}$ where P_{avg} is the average output power measured using an unclipped W-CDMA single-carrier input signal where output PAR is compressed to 7.0 dB @ 0.01% probability on CCDF.

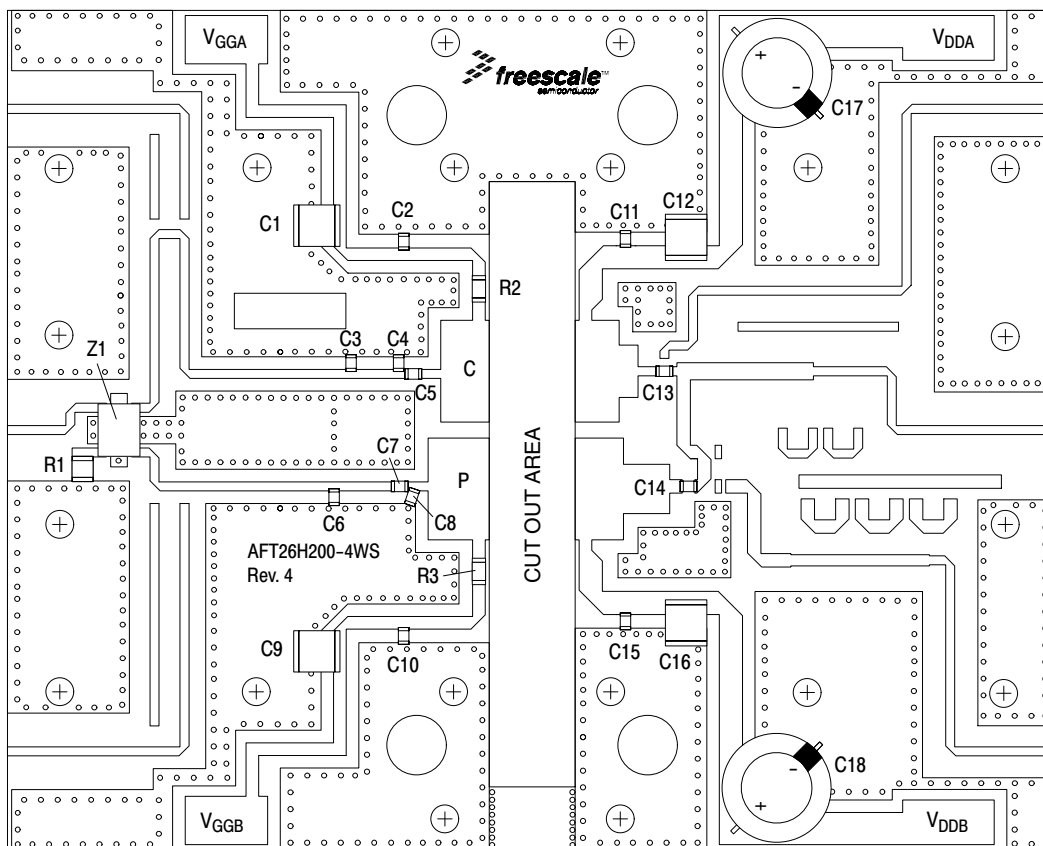

Note: V_{DDA} and V_{DDB} must be tied together and powered by a single DC power supply.

Figure 2. AFT26H200W03SR6 Test Circuit Component Layout

Table 5. AFT26H200W03SR6 Test Circuit Component Designations and Values

Part	Description	Part Number	Manufacturer
C1, C9, C12, C16	10 μ F Chip Capacitors	C5750X7S2A106M230KB	TDK
C2, C5, C7, C10, C11, C14, C15	6.8 pF Chip Capacitors	ATC600F6R8BT250XT	ATC
C3, C4	0.7 pF Chip Capacitors	ATC600F0R7BT250XT	ATC
C6, C8	0.5 pF Chip Capacitors	ATC600F0R5BT250XT	ATC
C13	2.0 pF Chip Capacitor	ATC600F2R0BT250XT	ATC
C17, C18	220 μ F, 50 V Electrolytic Capacitors	227CKS050M	Illinois Capacitor
R1	50 Ω , 4 W Chip Resistor	CW12010T0050GBK	ATC
R2, R3	3.0 Ω , 1/4 W Chip Resistors	CRCW12063R00FNEA	Vishay
Z1	2300–2700 MHz, 5 dB, Directional Coupler	X3C25P1-05S	Anaren
PCB	0.020", $\epsilon_r = 3.5$	RO4350B	Rogers

TYPICAL CHARACTERISTICS

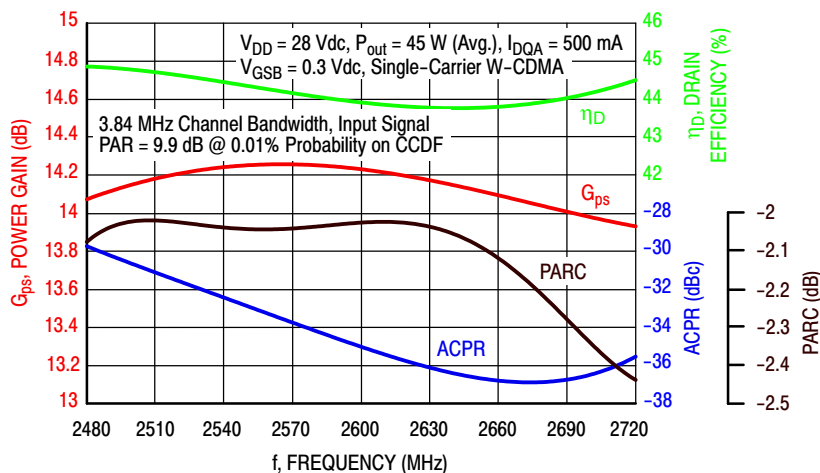

Figure 3. Single-Carrier Output Peak-to-Average Ratio Compression (PARC) Broadband Performance @ $P_{out} = 45$ Watts Avg.

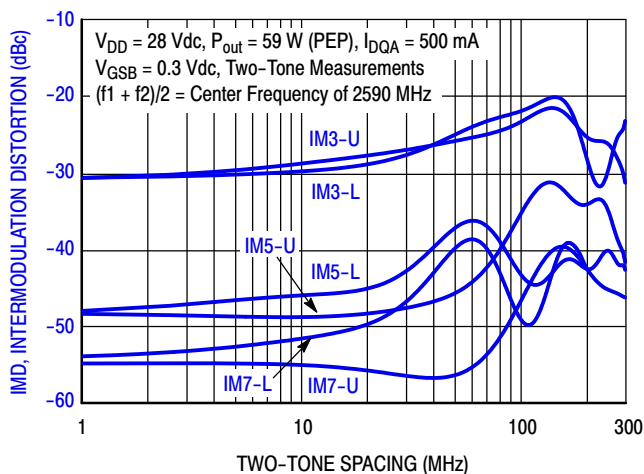

Figure 4. Intermodulation Distortion Products versus Two-Tone Spacing

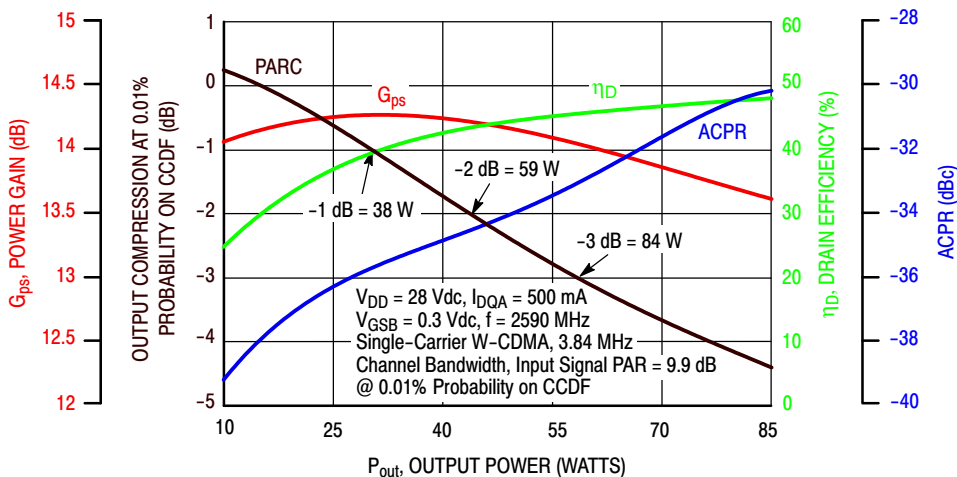

Figure 5. Output Peak-to-Average Ratio Compression (PARC) versus Output Power

TYPICAL CHARACTERISTICS

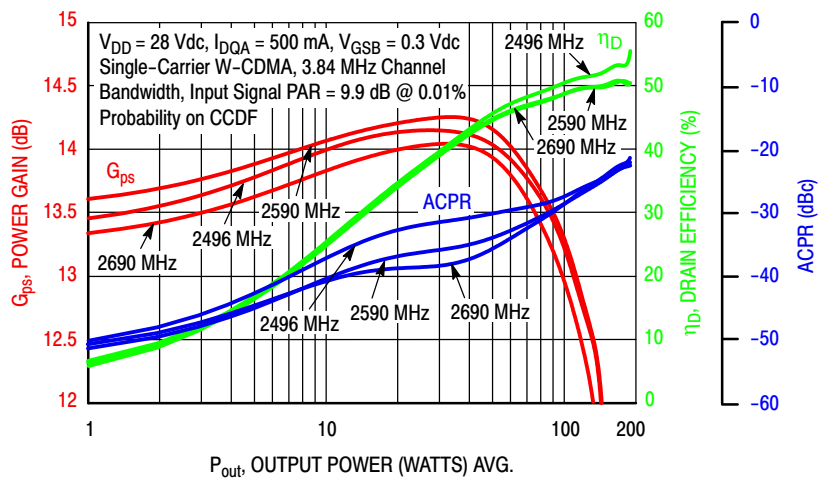

Figure 6. Single-Carrier W-CDMA Power Gain, Drain Efficiency and ACPR versus Output Power

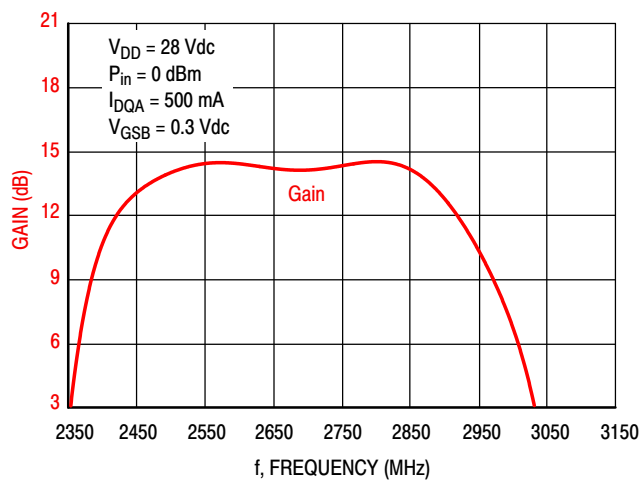

Figure 7. Broadband Frequency Response

$V_{DD} = 28 \text{ Vdc}$, $I_{DQA} = 494 \text{ mA}$, Pulsed CW, 10 $\mu\text{sec}(\text{on})$, 10% Duty Cycle

f (MHz)	$Z_{\text{source}} (\Omega)$	$Z_{\text{in}} (\Omega)$	Max Output Power					
			P1dB					
			$Z_{\text{load}}^{(1)} (\Omega)$	Gain (dB)	(dBm)	(W)	η_D (%)	AM/PM (°)
2496	9.09 - j14.0	8.87 + j13.4	4.40 - j8.11	17.3	50.3	107	53.1	-12
2590	16.1 - j13.2	15.2 + j12.7	4.32 - j8.14	17.5	50.3	107	53.6	-13
2690	22.9 - j0.41	20.5 + j1.37	4.28 - j8.80	17.5	50.2	104	52.2	-13

f (MHz)	$Z_{\text{source}} (\Omega)$	$Z_{\text{in}} (\Omega)$	Max Output Power					
			P3dB					
			$Z_{\text{load}}^{(2)} (\Omega)$	Gain (dB)	(dBm)	(W)	η_D (%)	AM/PM (°)
2496	9.09 - j14.0	9.41 + j14.6	4.15 - j8.72	15.1	51.0	127	53.7	-17
2590	16.1 - j13.2	17.5 + j13.6	4.16 - j8.90	15.2	51.0	127	53.7	-18
2690	22.9 - j0.41	22.2 - j1.34	4.21 - j9.41	15.2	50.9	123	52.3	-18

(1) Load impedance for optimum P1dB power.

(2) Load impedance for optimum P3dB power.

Z_{source} = Measured impedance presented to the input of the device at the package reference plane.

Z_{in} = Impedance as measured from gate contact to ground.

Z_{load} = Measured impedance presented to the output of the device at the package reference plane.

Figure 8. Carrier Side Load Pull Performance — Maximum Power Tuning

$V_{DD} = 28 \text{ Vdc}$, $I_{DQA} = 494 \text{ mA}$, Pulsed CW, 10 $\mu\text{sec}(\text{on})$, 10% Duty Cycle

f (MHz)	$Z_{\text{source}} (\Omega)$	$Z_{\text{in}} (\Omega)$	Max Drain Efficiency					
			P1dB					
			$Z_{\text{load}}^{(1)} (\Omega)$	Gain (dB)	(dBm)	(W)	η_D (%)	AM/PM (°)
2496	9.09 - j14.0	8.65 + j14.2	9.14 - j5.50	19.4	48.7	74	63.1	-20
2590	16.1 - j13.2	15.2 + j14.1	7.18 - j4.60	19.5	48.8	74	63.2	-21
2690	22.9 - j0.41	22.1 + j2.44	6.06 - j4.93	19.5	48.7	74	61.6	-21

f (MHz)	$Z_{\text{source}} (\Omega)$	$Z_{\text{in}} (\Omega)$	Max Drain Efficiency					
			P3dB					
			$Z_{\text{load}}^{(2)} (\Omega)$	Gain (dB)	(dBm)	(W)	η_D (%)	AM/PM (°)
2496	9.09 - j14.0	8.89 + j15.2	8.01 - j6.15	17.1	49.8	95	63.7	-26
2590	16.1 - j13.2	17.2 + j15.2	6.92 - j5.30	17.3	49.6	92	63.4	-27
2690	22.9 - j0.41	23.6 - j0.47	6.02 - j6.43	17.0	49.9	98	61.6	-25

(1) Load impedance for optimum P1dB efficiency.

(2) Load impedance for optimum P3dB efficiency.

Z_{source} = Measured impedance presented to the input of the device at the package reference plane.

Z_{in} = Impedance as measured from gate contact to ground.

Z_{load} = Measured impedance presented to the output of the device at the package reference plane.

Figure 9. Carrier Side Load Pull Performance — Maximum Drain Efficiency Tuning

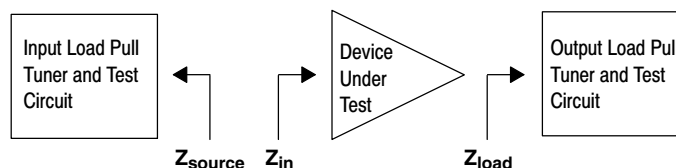

$V_{DD} = 28 \text{ Vdc}$, $V_{GSB} = 0.3 \text{ Vdc}$, Pulsed CW, 10 $\mu\text{sec}(\text{on})$, 10% Duty Cycle

f (MHz)	$Z_{\text{source}} (\Omega)$	$Z_{\text{in}} (\Omega)$	Max Output Power					
			P1dB					
			$Z_{\text{load}}^{(1)} (\Omega)$	Gain (dB)	(dBm)	(W)	η_D (%)	AM/PM (°)
2496	5.24 - j10.6	5.15 + j9.87	2.61 - j5.59	11.6	52.6	181	52.5	-19
2590	10.3 - j9.81	9.38 + j9.30	2.63 - j5.84	12.0	52.5	176	51.9	-20
2690	12.7 - j0.94	12.0 + j1.20	2.68 - j6.10	12.3	52.1	164	49.8	-20

f (MHz)	$Z_{\text{source}} (\Omega)$	$Z_{\text{in}} (\Omega)$	Max Output Power					
			P3dB					
			$Z_{\text{load}}^{(2)} (\Omega)$	Gain (dB)	(dBm)	(W)	η_D (%)	AM/PM (°)
2496	5.24 - j10.6	5.51 + j10.5	2.57 - j5.91	9.4	53.2	211	52.7	-25
2590	10.3 - j9.81	10.7 + j9.63	2.68 - j6.12	9.4	53.1	205	52.3	-25
2690	12.7 - j0.94	12.2 - j0.26	2.79 - j6.48	10.2	52.8	190	49.7	-25

(1) Load impedance for optimum P1dB power.

(2) Load impedance for optimum P3dB power.

Z_{source} = Measured impedance presented to the input of the device at the package reference plane.

Z_{in} = Impedance as measured from gate contact to ground.

Z_{load} = Measured impedance presented to the output of the device at the package reference plane.

Figure 10. Peaking Side Load Pull Performance — Maximum Power Tuning

$V_{DD} = 28 \text{ Vdc}$, $V_{GSB} = 0.3 \text{ Vdc}$, Pulsed CW, 10 $\mu\text{sec}(\text{on})$, 10% Duty Cycle

f (MHz)	$Z_{\text{source}} (\Omega)$	$Z_{\text{in}} (\Omega)$	Max Drain Efficiency					
			P1dB					
			$Z_{\text{load}}^{(1)} (\Omega)$	Gain (dB)	(dBm)	(W)	η_D (%)	AM/PM (°)
2496	5.24 - j10.6	4.66 + j10.2	5.91 - j4.19	12.8	51.1	129	61.3	-27
2590	10.3 - j9.81	8.53 + j10.5	4.92 - j2.75	13.2	50.6	116	61.2	-30
2690	12.7 - j0.94	13.2 + j3.53	3.52 - j2.21	13.1	49.7	93	59.0	-35

f (MHz)	$Z_{\text{source}} (\Omega)$	$Z_{\text{in}} (\Omega)$	Max Drain Efficiency					
			P3dB					
			$Z_{\text{load}}^{(2)} (\Omega)$	Gain (dB)	(dBm)	(W)	η_D (%)	AM/PM (°)
2496	5.24 - j10.6	5.08 + j10.8	5.29 - j4.65	10.7	52.0	160	61.9	-34
2590	10.3 - j9.81	10.2 + j10.5	4.64 - j4.15	11.1	52.0	158	61.2	-34
2690	12.7 - j0.94	13.3 + j1.00	3.85 - j3.19	11.2	51.0	127	58.2	-38

(1) Load impedance for optimum P1dB efficiency.

(2) Load impedance for optimum P3dB efficiency.

Z_{source} = Measured impedance presented to the input of the device at the package reference plane.

Z_{in} = Impedance as measured from gate contact to ground.

Z_{load} = Measured impedance presented to the output of the device at the package reference plane.

Figure 11. Peaking Side Load Pull Performance — Maximum Drain Efficiency Tuning

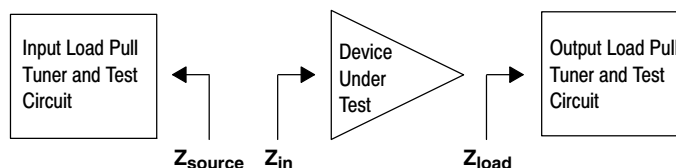

P1dB – TYPICAL CARRIER SIDE LOAD PULL CONTOURS — 2590 MHz

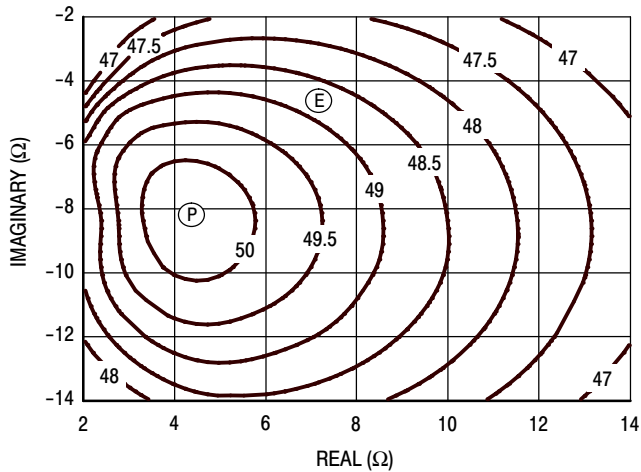

Figure 12. P1dB Load Pull Output Power Contours (dBm)

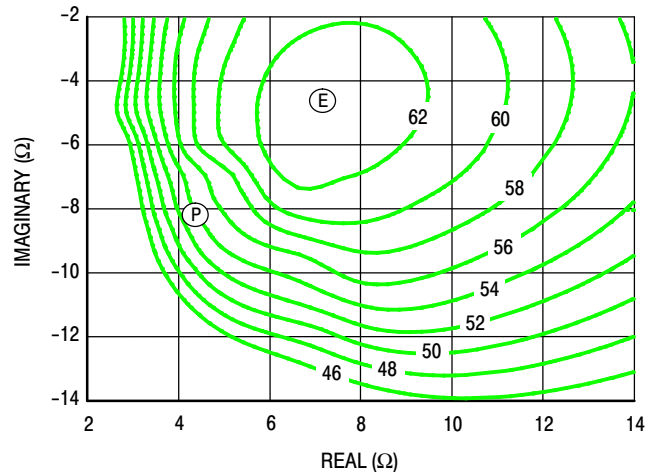

Figure 13. P1dB Load Pull Efficiency Contours (%)

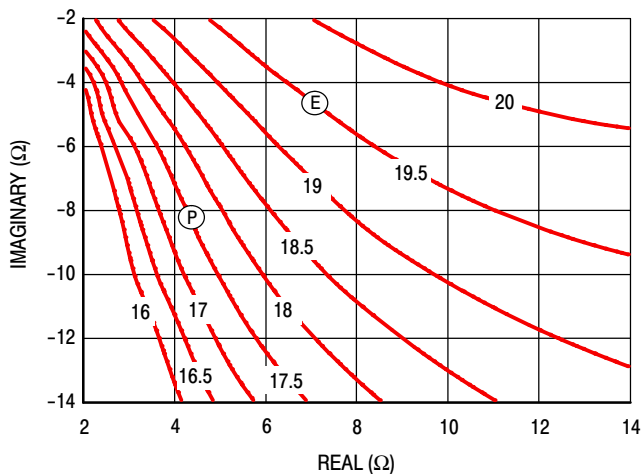

Figure 14. P1dB Load Pull Gain Contours (dB)

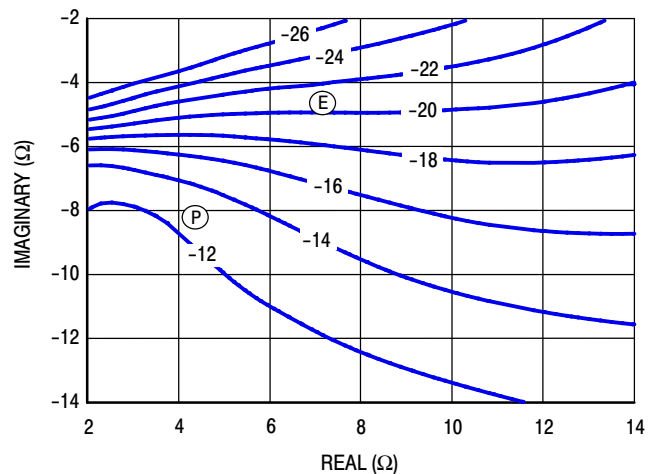

Figure 15. P1dB Load Pull AM/PM Contours (°)

NOTE: (P) = Maximum Output Power
(E) = Maximum Drain Efficiency

- Power Gain
- Drain Efficiency
- Linearity
- Output Power

P3dB – TYPICAL CARRIER SIDE LOAD PULL CONTOURS — 2590 MHz

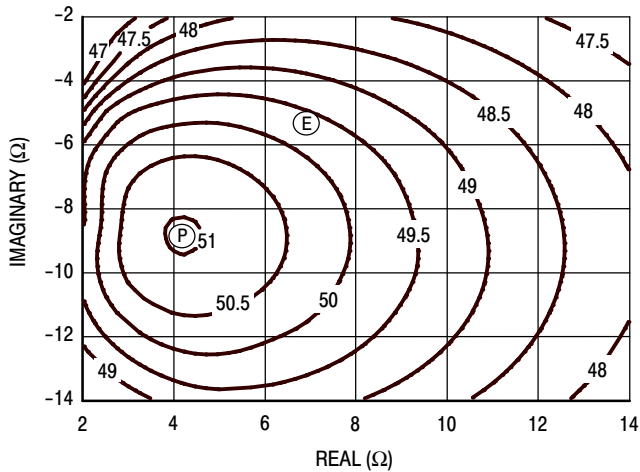

Figure 16. P3dB Load Pull Output Power Contours (dBm)

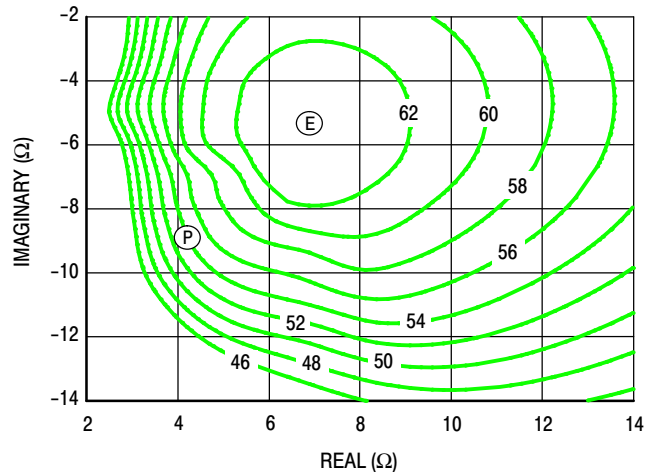

Figure 17. P3dB Load Pull Efficiency Contours (%)

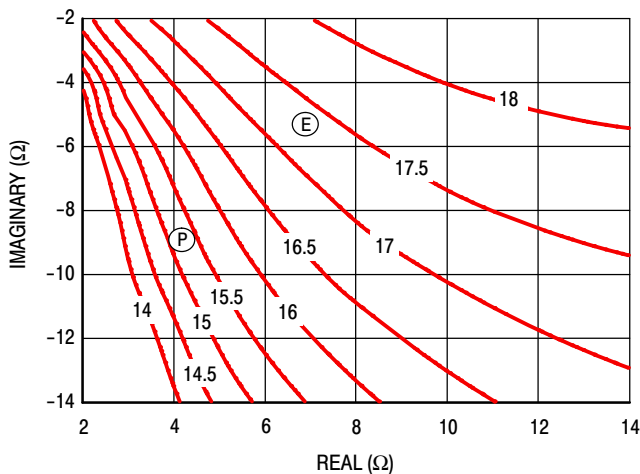

Figure 18. P3dB Load Pull Gain Contours (dB)

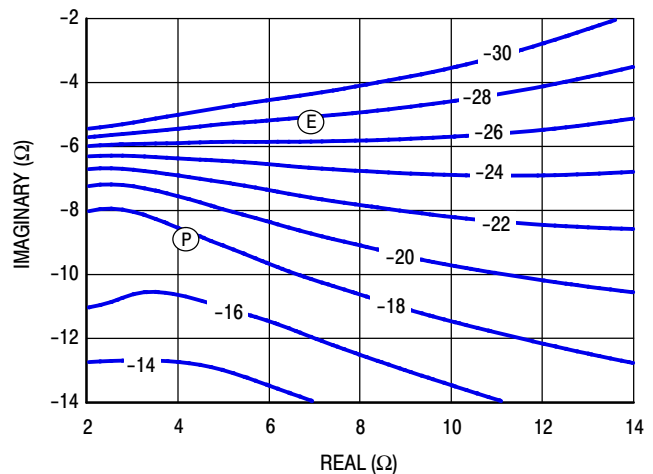

Figure 19. P3dB Load Pull AM/PM Contours (°)

NOTE: (P) = Maximum Output Power
(E) = Maximum Drain Efficiency

- Power Gain
- Drain Efficiency
- Linearity
- Output Power

P1dB – TYPICAL PEAKING SIDE LOAD PULL CONTOURS — 2590 MHz

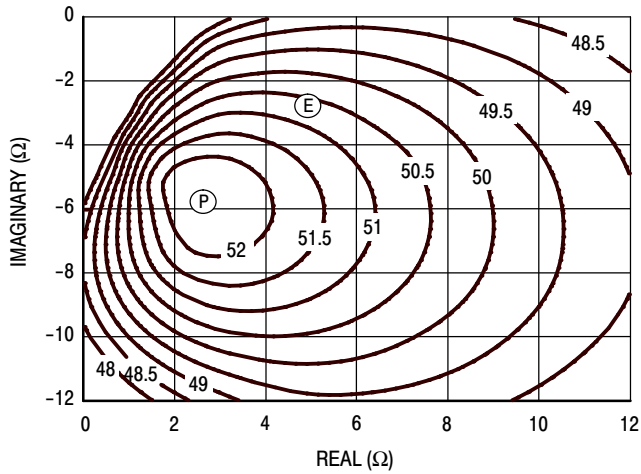

Figure 20. P1dB Load Pull Output Power Contours (dBm)

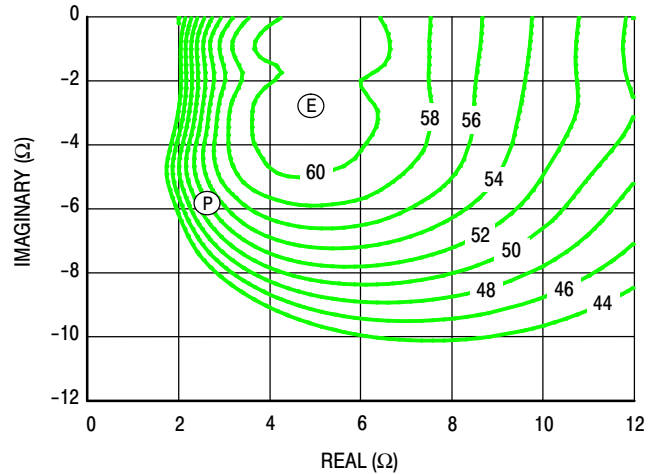

Figure 21. P1dB Load Pull Efficiency Contours (%)

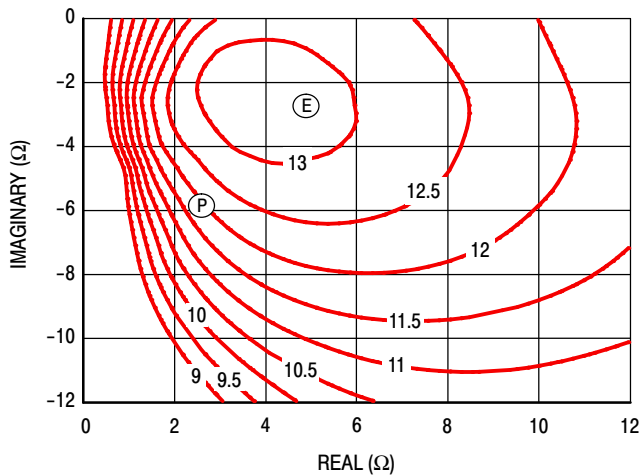

Figure 22. P1dB Load Pull Gain Contours (dB)

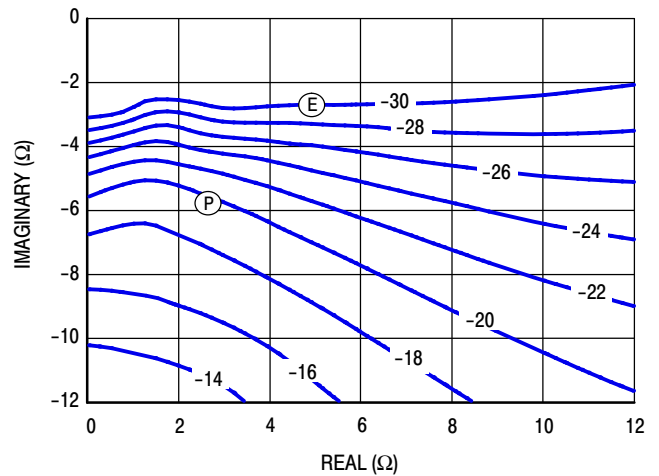

Figure 23. P1dB Load Pull AM/PM Contours (°)

NOTE: (P) = Maximum Output Power
(E) = Maximum Drain Efficiency

- Power Gain
- Drain Efficiency
- Linearity
- Output Power

P3dB – TYPICAL PEAKING SIDE LOAD PULL CONTOURS — 2590 MHz

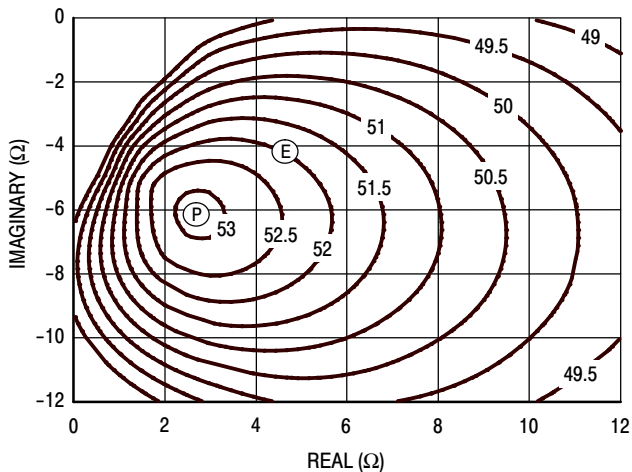

Figure 24. P3dB Load Pull Output Power Contours (dBm)

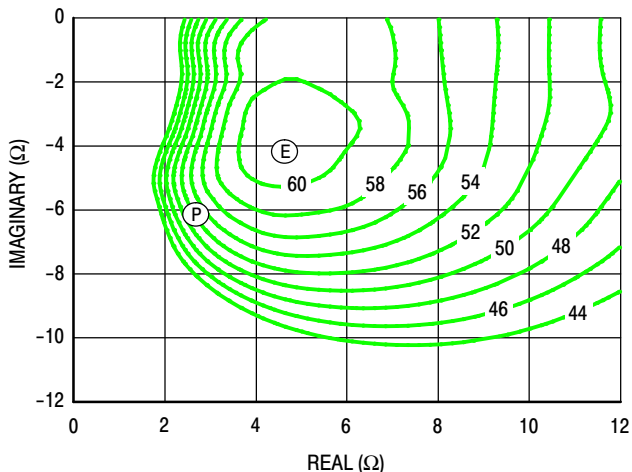

Figure 25. P3dB Load Pull Efficiency Contours (%)

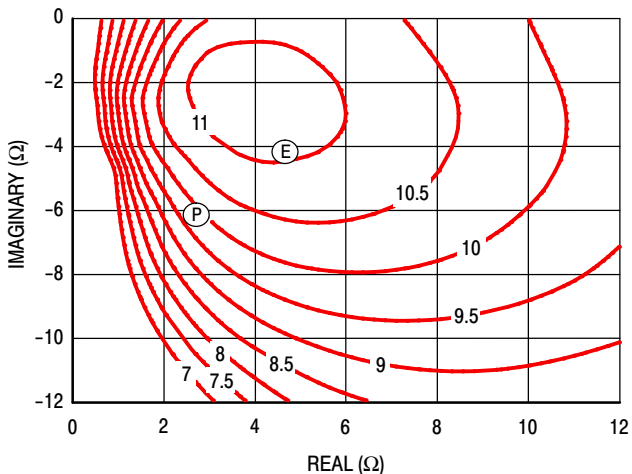

Figure 26. P3dB Load Pull Gain Contours (dB)

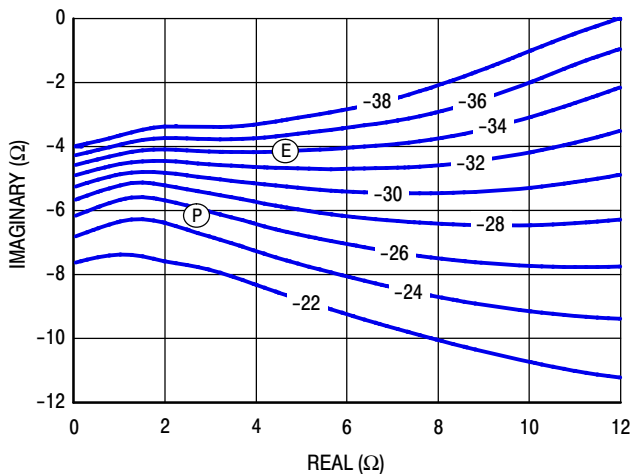

Figure 27. P3dB Load Pull AM/PM Contours (°)

NOTE: (P) = Maximum Output Power
(E) = Maximum Drain Efficiency

- Power Gain
- Drain Efficiency
- Linearity
- Output Power

NOTES:

1. INTERPRET DIMENSIONS AND TOLERANCES PER ASME Y14.5M-1994.
2. CONTROLLING DIMENSION: INCH
3. DIMENSION H IS MEASURED .030 INCH (0.762 MM) AWAY FROM PACKAGE BODY

DIM	INCHES		MILLIMETERS		DIM	INCHES		MILLIMETERS	
	MIN	MAX	MIN	MAX		MIN	MAX	MIN	MAX
AA	1.265	1.275	32.13	32.39	R	.355	.365	9.02	9.27
BB	.395	.405	10.03	10.29	S	.365	.375	9.27	9.53
CC	.170	.190	4.32	4.83	Z	R.000	R.040	R0.00	R1.02
D	.455	.465	11.56	11.81					
E	.062	.066	1.57	1.68	aaa	.013		0.33	
F	.004	.007	0.10	0.18	bbb	.010		0.25	
H	.082	.090	2.08	2.29	ccc	.020		0.51	
K	.117	.137	2.97	3.48					
L	.540 BSC		13.72 BSC						
M	1.219	1.241	30.96	31.52					
N	1.218	1.242	30.94	31.55					
© FREESCALE SEMICONDUCTOR, INC. ALL RIGHTS RESERVED.			MECHANICAL OUTLINE			PRINT VERSION NOT TO SCALE			
TITLE: NI-1230-4S					DOCUMENT NO: 98ARB18247C		REV: G		
					STANDARD: NON-JEDEC				
					01 MAR 2013				

PRODUCT DOCUMENTATION, SOFTWARE AND TOOLS

Refer to the following documents, software and tools to aid your design process.

Application Notes

- AN1955: Thermal Measurement Methodology of RF Power Amplifiers

Engineering Bulletins

- EB212: Using Data Sheet Impedances for RF LDMOS Devices

Software

- Electromigration MTTF Calculator
- RF High Power Model
- .s2p File

Development Tools

- Printed Circuit Boards

For Software and Tools, do a Part Number search at <http://www.freescale.com>, and select the "Part Number" link. Go to the Software & Tools tab on the part's Product Summary page to download the respective tool.

REVISION HISTORY

The following table summarizes revisions to this document.

Revision	Date	Description
0	Aug. 2013	<ul style="list-style-type: none">• Initial Release of Data Sheet

How to Reach Us:

Home Page:
freescale.com

Web Support:
freescale.com/support

Information in this document is provided solely to enable system and software implementers to use Freescale products. There are no express or implied copyright licenses granted hereunder to design or fabricate any integrated circuits based on the information in this document.

Freescale reserves the right to make changes without further notice to any products herein. Freescale makes no warranty, representation, or guarantee regarding the suitability of its products for any particular purpose, nor does Freescale assume any liability arising out of the application or use of any product or circuit, and specifically disclaims any and all liability, including without limitation consequential or incidental damages. "Typical" parameters that may be provided in Freescale data sheets and/or specifications can and do vary in different applications, and actual performance may vary over time. All operating parameters, including "typicals," must be validated for each customer application by customer's technical experts. Freescale does not convey any license under its patent rights nor the rights of others. Freescale sells products pursuant to standard terms and conditions of sale, which can be found at the following address: freescale.com/SalesTermsandConditions.

Freescale and the Freescale logo are trademarks of Freescale Semiconductor, Inc., Reg. U.S. Pat. & Tm. Off. Airfast is a trademark of Freescale Semiconductor, Inc. All other product or service names are the property of their respective owners.

© 2013 Freescale Semiconductor, Inc.



X-ON Electronics

Largest Supplier of Electrical and Electronic Components

Click to view similar products for [RF MOSFET Transistors](#) category:

Click to view products by [Freescale](#) manufacturer:

Other Similar products are found below :

[MRF166W](#) [MHT1006NT1](#) [FH2164](#) [MRFE8VP8600HR5](#) [BLF245](#) [BLF278](#) [ARF1511](#) [ARF465BG](#) [BF 2030 E6814](#) [BLF861A](#) [3SK263-5-TG-E](#) [VRF154FL](#) [MRF6S20010GNR1](#) [DU1215S](#) [DU28200M](#) [VRF150MP](#) [MMRF1015NR1](#) [MRF154](#) [MRF175LU](#) [MRF6S20010GNR1](#) [UF28100M](#) [MW6S010GNR1](#) [MW6S010GNR1](#) [DU2820S](#) [SD2943W](#) [SD2932BW](#) [SD2941-10W](#) [MRF24301HR5](#) [ARF469AG](#) [ARF463BP1G](#) [MMRF1019NR4](#) [MHT1008NT1](#) [MMRF1014NT1](#) [MRF426](#) [MRF422](#) [BLW96](#) [ARF468AG](#) [VRF161MP](#) [ARF468BG](#) [MRFE6VP61K25NR6](#) [MRFE6VP5300NR1](#) [A2T27S020NR1](#) [UF2840P](#) [MMRF1304NR1](#) [MRFE6S9060GNR1](#) [MMRF1008GHR5](#) [A2T27S007NT1](#) [AFT09MP055NR1](#) [DU2860U](#) [MHT1803A](#)