

Soldering - Solderen - Soudage - Lötten - Soldadura - Löding - Juottaminen - Saldatura - Solda

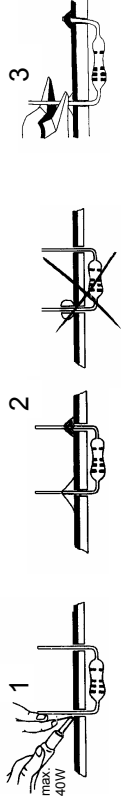

**START** 1

Resistor - Weerstand - Résistance - Widerstand - Resistencia - Motstand - Vastus - Resistenze		<ul style="list-style-type: none"> <li>◇ R1, R2 : 330</li> <li>◇ R3 : 470</li> <li>◇ R4 : 100K</li> <li>◇ R5 : 47K</li> <li>◇ R6, R7, 4K7</li> <li>◇ R8 : 10K</li> <li>◇ R9 : 10</li> <li>◇ R10 : 1K2</li> </ul>
---	--	--

9 PCB tabs

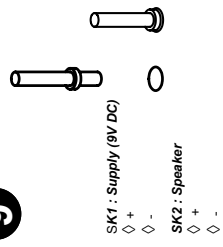

10 Microphone

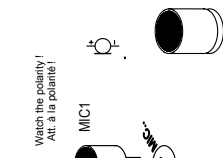

11 Electrolytic capacitors



12 Vertical trimmer

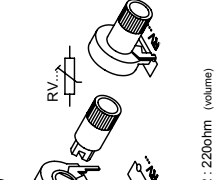

13 Connection

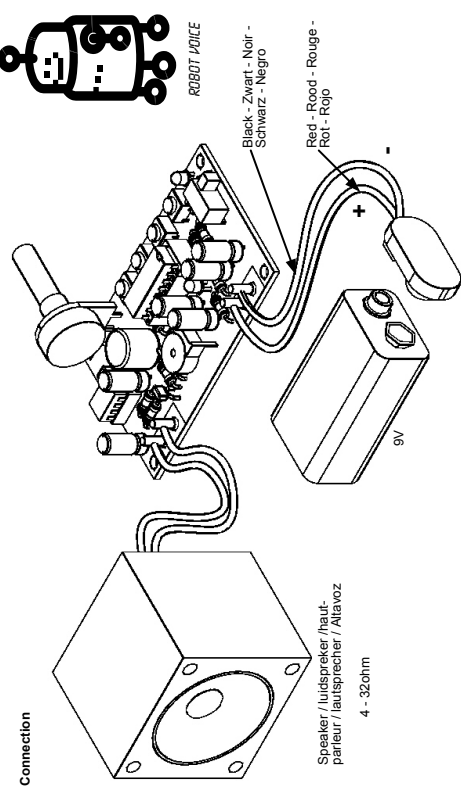

14 IC

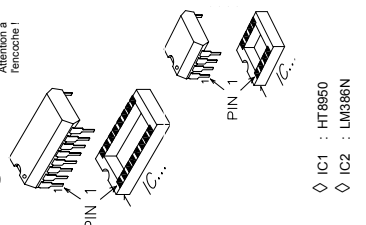

15 Diagram

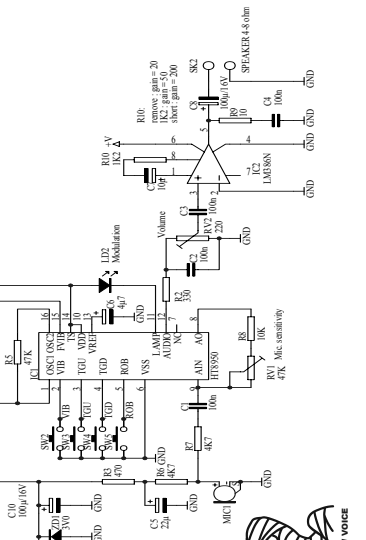

2 Zenodiode

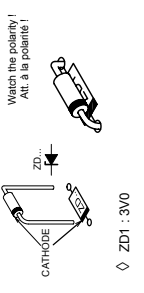

3 Pushbutton

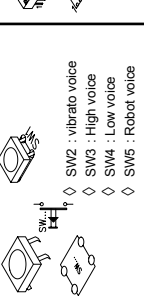

4 IC-socket

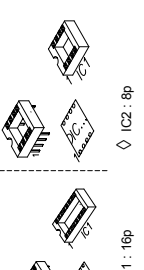

5 Slide switch

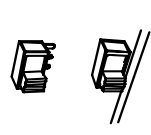

6 Leds

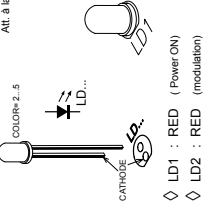

7 Horizontal trimmer

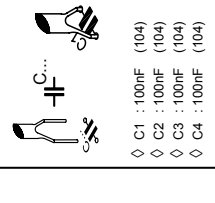

8 Capacitors

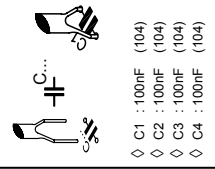

## **X-ON Electronics**

Largest Supplier of Electrical and Electronic Components

*Click to view similar products for [Velleman](#) manufacturer:*

Other Similar products are found below :

[MK137](#) [MK106](#) [K2622](#) [K/DIODE1](#) [72-6514](#) [MK108](#) [K8072](#) [K2634](#) [80-7352](#) [K/TF300](#) [MK149](#) [HPS140MK2](#) [VM100](#) [MK123](#) [MK144](#)  
[MK152](#) [K8086](#) [K/RES-E12](#) [MK190](#) [MK134](#) [K/TRANS1](#) [CD018](#) [K1803](#) [K/RES-E3](#) [MK111](#) [MK103](#) [MK100](#) [OMSB36](#) [K/CAP1](#) [MK109](#)  
[MK120](#) [MK135](#) [MK150](#) [MK112](#) [VTHH6](#)