

Soldering - Solderen - Soudage - Lötten - Soldadura - Lötning - Juottaminen - Soldatura - Solda

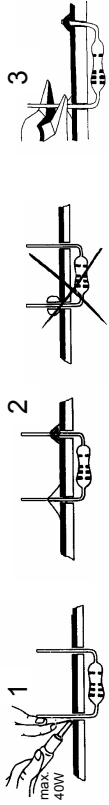

START

1
Resistor - Weerstand - Résistance - Widerstand - Resistencia - Motstånd - Vastus - Resistenze

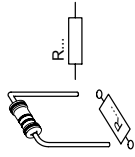

- ◇ R1 : 2K2
- ◇ R2 : 220K
- ◇ R3, R4 : 1M
- ◇ R5 : 1K
- ◇ R6 ... R8 : 470
- ◇ R9 : 220

(Red, Red, Red) - (Rood, Rood, Rood) - (Rouge, Rouge, Rouge) - (Rot, Rot, Rot) - (Röd, Röd, Röd) - (Punainen, Punainen, Punainen) - (Rojo, Rojo, Rojo) - (Encarnado, Encarnado, Encarnado) - (Rosso, Rosso, Rosso)

(Red, Red, Yellow) - (Rood, Rood, Geel) - (Rouge, Rouge, Jaune) - (Rot, Rot, Gelb) - (Röd, Röd, Gul) - (Punainen, Punainen, Keltainen) - (Rojo, Rojo, Amarillo) - (Encarnado, Encarnado, Amaraleo) - (Rosso, Rosso, Giallo)

(Brown, Black, Green) - (Bruin, Zwart, Groen) - (Brun, Noir, Vert) - (Braun, Schwarz, Grün) - (Brun, Svart, Grön) - (Ruskea, Musta, Vihreä) - (Marrón, Negro, Verde) - (Castanho, Preto, Verde) - (Marrone, Nero, Verde)

(Brown, Black, Red) - (Bruin, Zwart, Rood) - (Brun, Noir, Rouge) - (Braun, Schwarz, Rot) - (Brun, Svart, Röd) - (Ruskea, Musta, Punainen) - (Marrón, Negro, Rojo) - (Castanho, Preto, Encarnado) - (Marrone, Nero, Rosso)

(Yellow, Purple, Brown) - (Geel, Paars, Bruin) - (Jaune, Violet, Brun) - (Gelb, Violett, Braun) - (Gul, Lila, Brun) - (Keltainen, Purppura, Ruskea) - (Amarillo, Morado, Marrón) - (Anarêlo, Violeta, Castanho) - (Giallo, Viola, Marrone) - (Gul, Violet, Bruin)

(Red, Red, Brown) - (Rood, Rood, Bruin) - (Rouge, Rouge, Brun) - (Rot, Rot, Braun) - (Röd, Röd, Brun) - (Punainen, Punainen, Ruskea) - (Rojo, Rojo, Marrón) - (Encarnado, Encarnado, Castanho) - (Rosso, Rosso, Marrone)

2
CAPACITORS

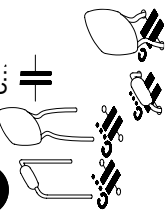

- ◇ C1 : 470 nF (µ47, 474, 0.47)

3
DIODE

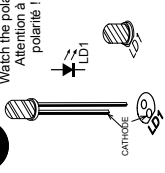

- ◇ LD1 ... LD5 (3mm)

4
PHOTOTRANSISTOR

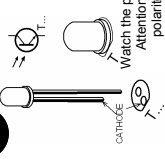

- ◇ T4 : L-5393C (5mm)

5
TRANSISTORS



- ◇ T1, T2 : BC557
- ◇ T3 : BC547

6
SWITCH

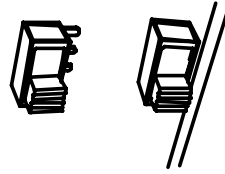

- ◇ SW1

7
BATTERY HOLDER & FINAL ASSEMBLY

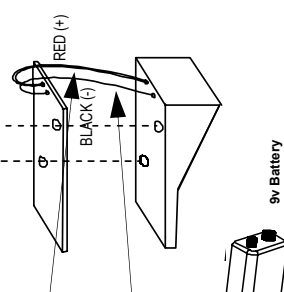

Watch the polarity !
Attention à la polarité !

SCHEMATIC DIAGRAM

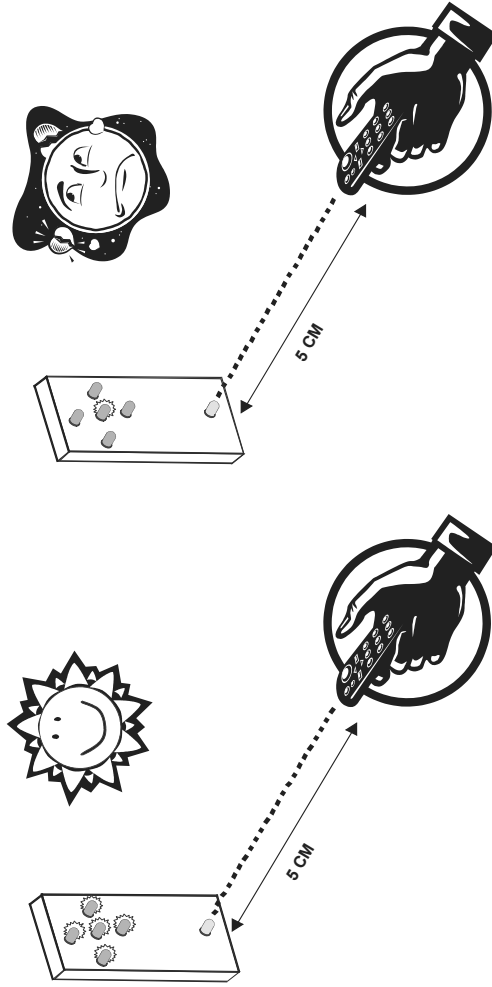
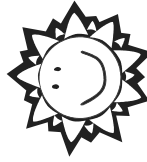
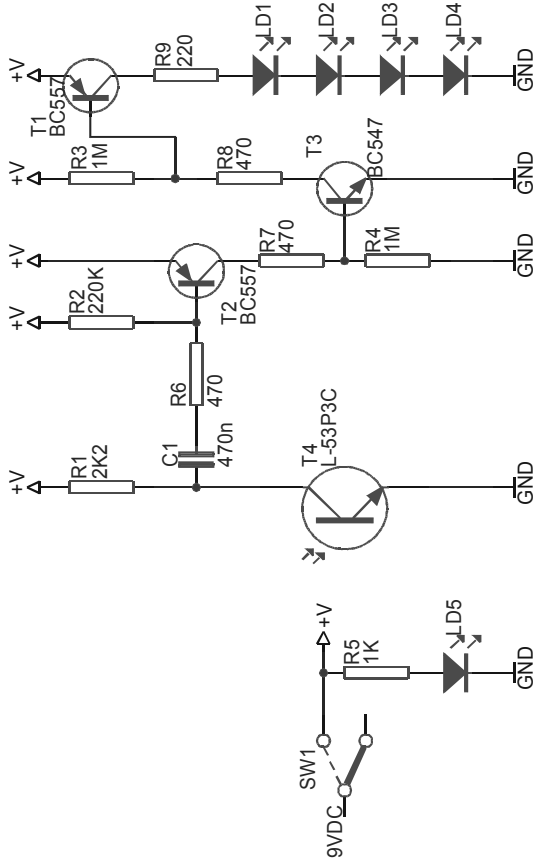

X-ON Electronics

Largest Supplier of Electrical and Electronic Components

Click to view similar products for [Velleman](#) manufacturer:

Other Similar products are found below :

[MK137](#) [MK106](#) [K2622](#) [K/DIODE1](#) [72-6514](#) [MK108](#) [K8072](#) [K2634](#) [80-7352](#) [K/TF300](#) [MK149](#) [HPS140MK2](#) [VM100](#) [MK123](#) [MK144](#)
[MK152](#) [K8086](#) [K/RES-E12](#) [MK190](#) [MK134](#) [K/TRANS1](#) [CD018](#) [K1803](#) [K/RES-E3](#) [MK111](#) [MK103](#) [MK100](#) [OMSB36](#) [K/CAP1](#) [MK109](#)
[MK120](#) [MK135](#) [MK150](#) [MK112](#) [VTHH6](#)