

Soldering - Solderen - Soudage - Löten - Soldadura - Lötning - Juottami nen - Saldatura - Solda

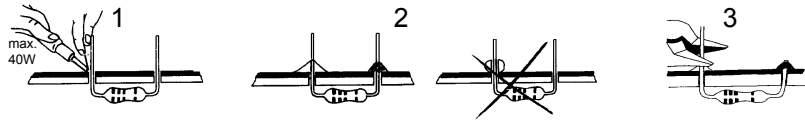

**START** **1** Jumpwire - Draadbrug - Pontage

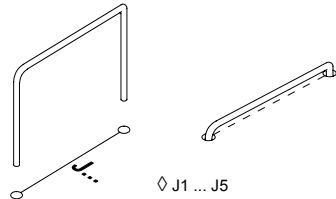

◇ J1 ... J5

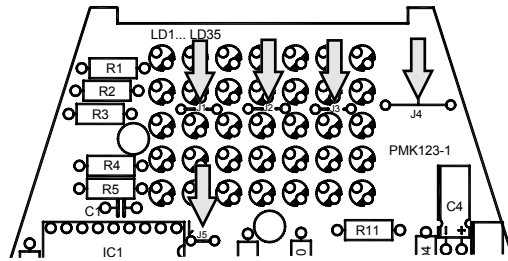

**2** Resistor - Weerstand - Résistance - Widerstand - Resistencia - Motstand - Vastus - Resistenze

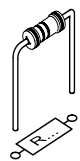

- ◇ R1... R6: 330 Ohm
- ◇ R7, R8: 10K
- ◇ R9... R11: 0 ohm

(Orange, Orange, Brown) - (Oranje, Oranje, Bruin) - (Orange, Orange, Brun) - (Orange, Orange, Braun) - (Orange, Orange, Brun) - (Oranssi, Oranssi, Ruskea) - (Naranjado, Naranjado, Marrón) - (Laranja, Laranja, Castanho) - (Aranciato, Aranciato, Marrone)

(Brown, Black, Orange) - (Bruin, Zwart, Oranje) - (Brun, noir, Orange) - (Braun, Schwarz, Orange) - (Brun, Svart, Orange) - (Ruskea, Musta, Oranssi) - (Marrón, Negro, Naranjado) - (Castanho, Preto, Laranja) - (Marrone, Nero, Aranciato)

(Black) - (zwart) - (noir) - (Schwarz) - (Svart) - (Musta) - (Negro) - (Preto) - (Nero)



MK123\_rev.1

**3** Diode

Watch the polarity!  
Attention à la polarité!

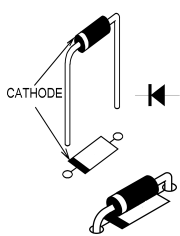

◇ D1 ... D4 : 1N4148

**4** CAPACITOR

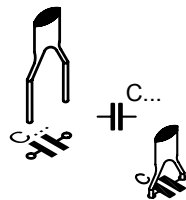

- ◇ C1 : 100nF (104)
- ◇ C2 : 22pF
- ◇ C3 : 5pF (3p ... 6p)

**5** QUARTZ CRYSTAL

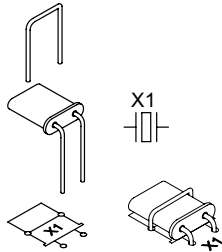

◇ X1 : 4,194304

**6** ELECTROLYTIC CAPACITORS

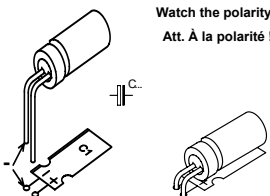

Watch the polarity!  
Att. À la polarité!

◇ C4, C5 : 4,7µF

**7** LED

Watch the polarity!  
Att. la polarité!

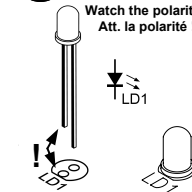

◇ LD1... LD35

**8** VOLTAGE REGULATOR

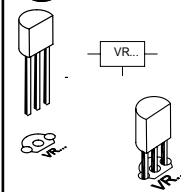

◇ VR1: 78L05

**9** TRIM CAPACITOR

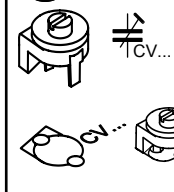

◇ CV1: 3-10pF

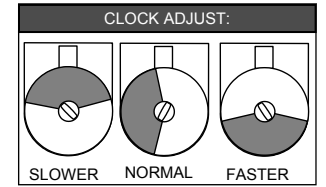

**10** PUSH BUTTON

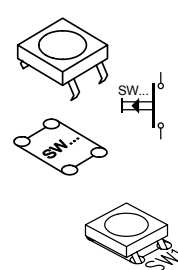

- ◇ SW1 : set
- ◇ SW2 : select

**11** SOCKET + IC

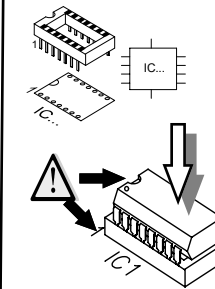

◇ IC1: VMK123  
(Programmed PIC16C54)

**12** POWER JACK

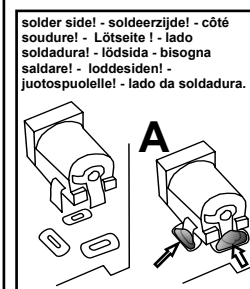

◇ SK1

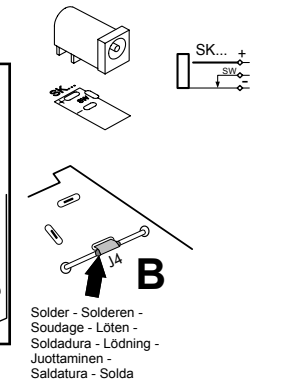

solder side! - soldeerzijde! - côté soudure! - Lötseite! - lado soldadura! - lödsida - bisogna saldare! - loddesiden! - juotospuolelle! - lado da soldadura.

Solder - Solderen - Soudage - Lötten - Soldadura - Lötning - Juottaminen - Saldatura - Solda

**13** BATTERY HOLDER

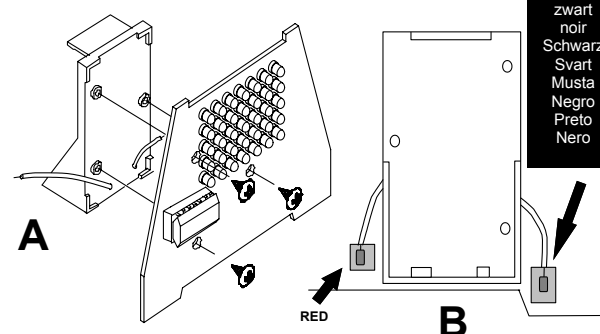

Black  
zwart  
noir  
Schwarz  
Svart  
Musta  
Negro  
Preto  
Nero

**14** DISPLAY

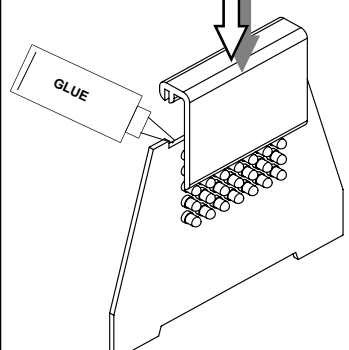

## **X-ON Electronics**

Largest Supplier of Electrical and Electronic Components

*Click to view similar products for [Velleman](#) manufacturer:*

Other Similar products are found below :

[MK137](#) [MK106](#) [K2622](#) [K/DIODE1](#) [72-6514](#) [MK108](#) [K8072](#) [K2634](#) [80-7352](#) [K/TF300](#) [MK149](#) [HPS140MK2](#) [VM100](#) [MK123](#) [MK144](#)  
[MK152](#) [K8086](#) [K/RES-E12](#) [MK190](#) [MK134](#) [K/TRANS1](#) [CD018](#) [K1803](#) [K/RES-E3](#) [MK111](#) [MK103](#) [MK100](#) [OMSB36](#) [K/CAP1](#) [MK109](#)  
[MK120](#) [MK135](#) [MK150](#) [MK112](#) [VTHH6](#)