

Soldering - Solderen - Soudage - Löten - Soldadura - Lödning - Juottaminen - Saldatura - Solda

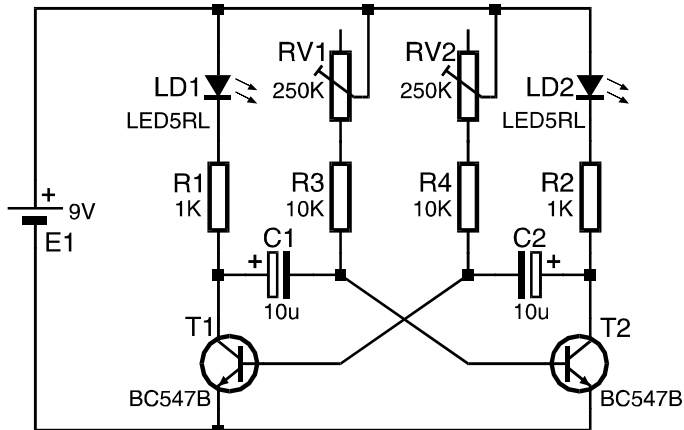

VELLEMAN KIT NV
 Legen Heirweg 33
 9890 Gavere
 Belgium
 Email: Support@velleman.be

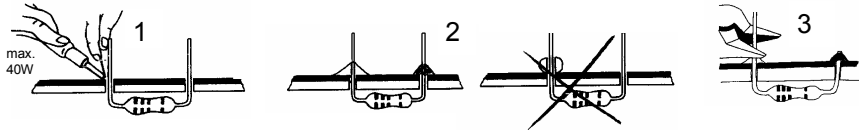

1 Resistor - Weerstand -
 Resistance - Widerstand -
 Resistencia - Motstand -
 Vastus - Resistenze

∅R1: 1K (Brown, Black, Red) - (Bruin, Zwart, Rood) - (Brun, Noir, Rouge)
 (Braun, Schwarz, Rot) - (Brun, Svart, Röd)
 (Ruskea, Musta, Punainen) - (Marrón, Negro, Rojo)
 (Castanho, Preto, Encarnado) - (Marrone, Nero, Rosso)

∅R3: 10K (Brown, Black, Orange) - (Bruin, Zwart, Oranje) - (Brun, noir, Orange)
 (Braun, Schwarz, Orange) - (Brun, Svart, Orange)
 (Ruskea, Musta, Oranssi) - (Marrón, Negro, Naranjado)
 (Castanho, Preto, Laranja) - (Marrone, Nero, Aranciato)

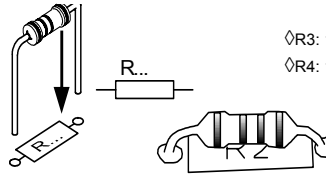

2 Trimpotentiometer - Potentiomètre de réglage -
 Potentiómetro de regulación - Trimmerpotentiometri -
 Trimme-potentiometer - Trimmer potenziometri

∅RV1: 220K (250K)
 ∅RV2: 220K (250K)

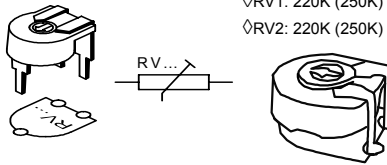

3 Transistor
 ∅T1: BC547
 ∅T2: BC547

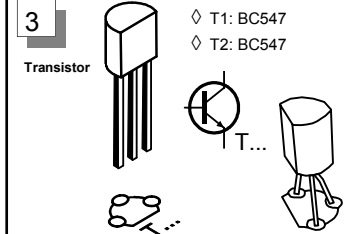

4 ELCO

∅C1: 10µF
 ∅C2: 10µF
 Watch the polarity !

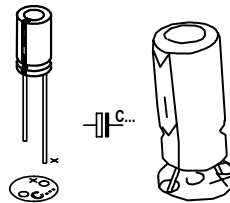

5 LED

∅LD1: 5mm
 ∅LD2: 5mm
 COLOR = 2...5 Watch the polarity !

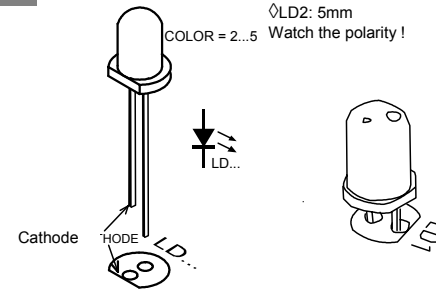

6

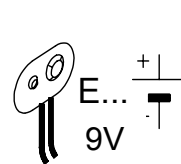

Red - Rood - Rouge - Rot - Röd -

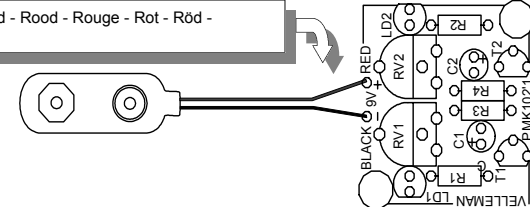

X-ON Electronics

Largest Supplier of Electrical and Electronic Components

Click to view similar products for [Velleman](#) manufacturer:

Other Similar products are found below :

[MK137](#) [MK106](#) [K2622](#) [K/DIODE1](#) [72-6514](#) [MK108](#) [K8072](#) [K2634](#) [80-7352](#) [K/TF300](#) [MK149](#) [HPS140MK2](#) [VM100](#) [MK123](#) [MK144](#)
[MK152](#) [K8086](#) [K/RES-E12](#) [MK190](#) [MK134](#) [K/TRANS1](#) [CD018](#) [K1803](#) [K/RES-E3](#) [MK111](#) [MK103](#) [MK100](#) [OMSB36](#) [K/CAP1](#) [MK109](#)
[MK120](#) [MK135](#) [MK150](#) [MK112](#) [VTHH6](#)