

Soldering - Solderen - Soudage - Löten - Soldadura - Lödning - Juottaminen - Saldatura - Solda

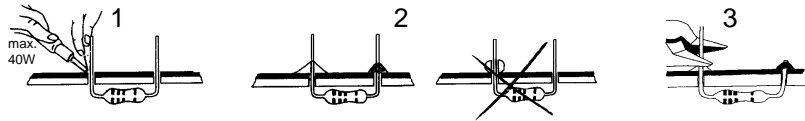

START

1

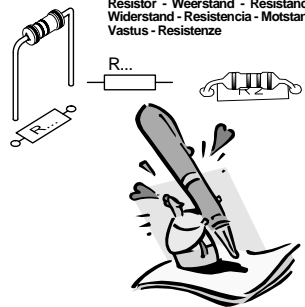

◇ R1, R2 : 100	(Brown, Black, Brown) - (Bruin, zwart, Brown) - (Brun, noir, Brun) - (Braun, Schwarz, Braun) - (Brun, Svart, Brun) - (Ruskea, Musta, Ruskea) - (Marrón, Negro, Marrón) - (Castanho, Preto, Castanho) - (Marrone, Nero, Marrone)
◇ R3 ... R6 : 1K	(Brown, Black, Red) - (Bruin, Zwart, Rood) - (Brun, Noir, Rouge) - (Braun, Schwarz, Rot) - (Brun, Svart, Röd) - (Ruskea, Musta, Punainen) - (Marrón, Negro, Rojo) - (Castanho, Preto, Encarnado) - (Marrone, Nero, Rosso)
◇ R7, R8 : 10K	(Brown, Black, Orange) - (Bruin, Zwart, Oranje) - (Brun, noir, Orange) - (Braun, Schwarz, Orange) - (Brun, Svart, Orange) - (Ruskea, Musta, Oranssi) - (Marrón, Negro, Rojo) - (Castanho, Preto, Laranja) - (Marrone, Nero, Aranciato)
◇ R9 ... R12 : 100K	(Brown, Black, Yellow) - (Bruin, zwart, Geel) - (Brun, noir, Jaune) - (Braun, Schwarz, Gelb) - (Brun, Svart, Gul) - (Ruskea, Musta, Keltainen) - (Marrón, Negro, Amarillo) - (Castanho, Preto, Amarelo) - (Marrone, Nero, Giallo)
◇ R13 : 150	(Brown, Green, Brown) - (Bruin, Groen, Bruin) - (Brun, Vert, Brun) - (Braun, Grün, Braun) - (Brun, Grön, Brun) - (Ruskea, Vihreä, Ruskea) - (Marrón, Verde, Marrón) - (Castanho, Verde, Castanho) - (Marrone, Verde, Marrone)
◇ R14 : 470	(Yellow, Purple, Brown) - (Geel, Paars, Bruin) - (Jaune, Violet, Brun) - (Gelb, Violet, Braun) - (Gul, Lila, Brun) - (Keltainen, Purppura, Ruskea) - (Amarillo, Morado, Marrón) - (Amarelo, Violeta, Castanho) - (Giallo, Viola, Marrone) - (Gul, Violet, Brun)

2

DIODE

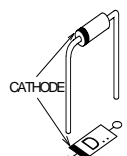

◇ D1 : 1N4148

3

CAPACITOR

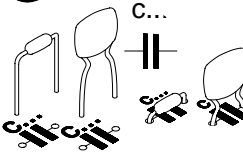

◇ C5 ... C7 : 100nF (104)
◇ C8 : 3n9 (392)

4

IC SOCKETS

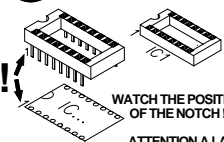

◇ IC1 : 14p
◇ IC2 : 18p

5

TRIMMER

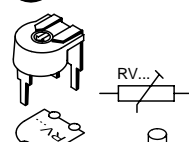

◇ RV1 : 220K

6 LED'S

Watch the polarity!
Attention à la polarité!

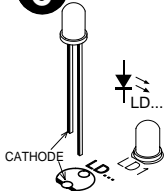

◇ LD1, LD2 : Red, Rood, Rouge, Rot, Röd, Punainen, Rojo, Encarnado, Rosso
◇ LD3 ... LD5 : Yellow, Geel, Jaune, Gelb, Gul, Keltainen, Amarillo, Amarelo, Giallo
◇ LD6 ... LD10 : Green, Groen, Vert, Grün, Grön, Vihreä, Verde

7 TRANSISTORS

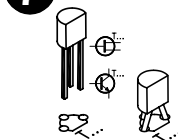

◇ T1 : BC557
◇ T2 : BC547

8 VOLTAGE REGULATOR

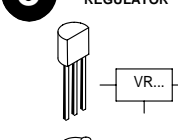

◇ VR1 : UA78L05

9 SWITCH

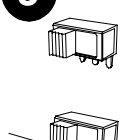

◇ SW1

11 BUZZER

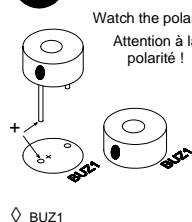

◇ BUZ1

12 IC'S

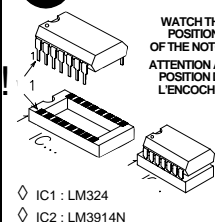

◇ IC1 : LM324
◇ IC2 : LM3914N

13 ELECTROLYTIC CAPACITORS

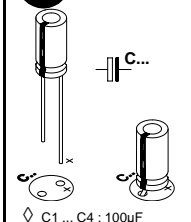

◇ C1 ... C4 : 100µF

14 BATTERYHOLDER

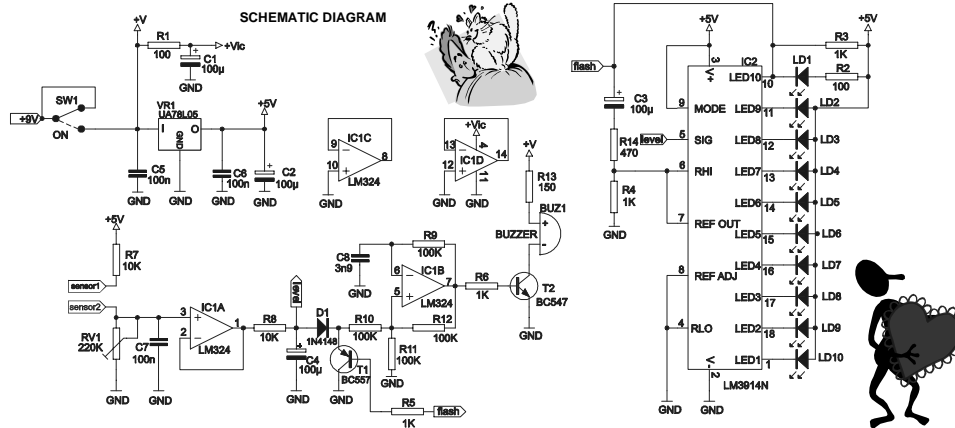
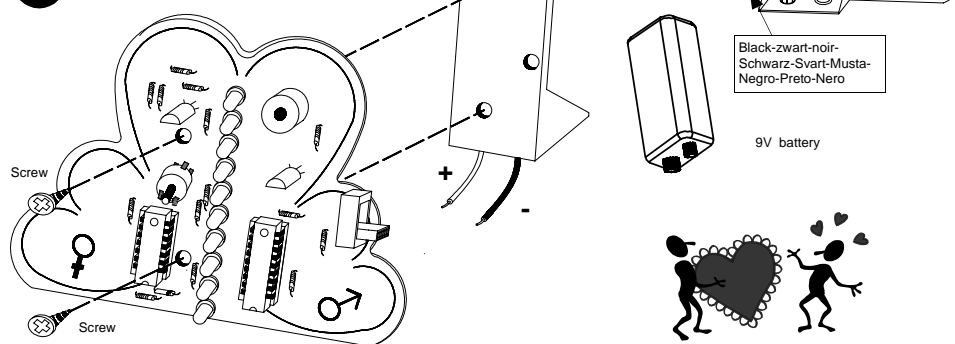

X-ON Electronics

Largest Supplier of Electrical and Electronic Components

Click to view similar products for [Velleman](#) manufacturer:

Other Similar products are found below :

[MK137](#) [MK106](#) [K2622](#) [K/DIODE1](#) [72-6514](#) [MK108](#) [K8072](#) [K2634](#) [80-7352](#) [K/TF300](#) [MK149](#) [HPS140MK2](#) [VM100](#) [MK123](#) [MK144](#)
[MK152](#) [K8086](#) [K/RES-E12](#) [MK190](#) [MK134](#) [K/TRANS1](#) [CD018](#) [K1803](#) [K/RES-E3](#) [MK111](#) [MK103](#) [MK100](#) [OMSB36](#) [K/CAP1](#) [MK109](#)
[MK120](#) [MK135](#) [MK150](#) [MK112](#) [VTHH6](#)