



Datenblatt - Fiche technique - Data sheet

**11.02.8313**



ROLINE USB 2.0 Magnet-Steckerkopf, Micro B, ST, 3 Stück

ROLINE Adaptateur magnétique pour 11.02.8312, 3x

ROLINE Detachable Magnetic Connector for 11.02.8312, 3 pcs.

1

2

3

4

5

6

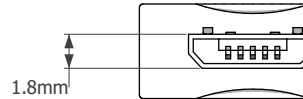
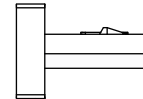
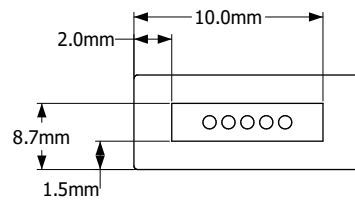
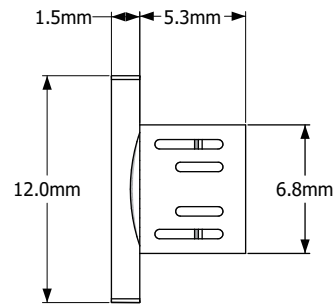
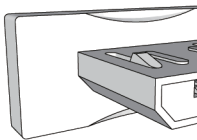
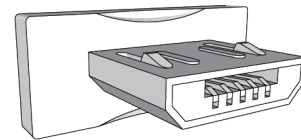
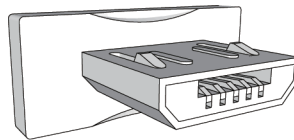

Description :

1. Micro B Magnetic Suction Connector \*3pcs

REV.	DATE	CONTENTS OF CHANGE	DESIGNER	TOL ±								APPROVAL	CHECK	DRAWING	DESIGN		
				RANGE	Pla	Met	Ins	Por	V	Cab	Pac					Gas	DIS
①				0~6	0.1	0.1	0.1	0.2	0.5	1	0.5	0.2	Allen	Allen		Philip	
②				6~30	0.1	0.1	.15	.25	1	1	0.5	.25					
③				30~80	0.1	.15	0.2	0.3	2	1.5	1	0.3					
④				80~180	.15	.15	.25	0.3	2	2	1	.45					
⑤				180~315	.15	0.2	0.3	0.4	2.5	2	1	0.6					
⑥				315~800	0.2	0.3	0.4	0.5	3	3	2	1.1	⑦	SCALE	1 : 2.5	UNIT	mm

1

2

3

4

5

6

## X-ON Electronics

Largest Supplier of Electrical and Electronic Components

*Click to view similar products for [Roline manufacturer](#):*

Other Similar products are found below :

[11.04.5710](#) [11.04.5547](#) [11.04.5779](#) [11.04.5789](#) [11.02.8877](#) [11.04.5690](#) [11.04.5792](#) [11.04.5793](#) [11.04.5202](#) [12.03.3114](#) [11.04.5552](#)  
[11.04.5601](#) [11.02.8311](#) [11.02.8753](#) [12.04.1088](#) [11.02.8902](#) [11.02.9025](#) [21.15.0831](#) [21.15.0833](#) [21.15.2713](#) [21.15.2720](#) [21.15.2762](#)  
[11.09.4446](#) [11.04.5609](#) [12.02.1041](#) [21.15.0591](#) [11.04.5736](#) [11.04.5691](#) [26.11.0378](#) [12.03.3119](#) [11.01.6230](#) [11.04.5595](#) [11.09.4345](#)  
[11.09.4510](#) [21.15.0830](#) [21.15.2606](#) [16.01.3031](#) [11.02.8722](#) [11.02.8780](#) [11.04.5619](#) [11.04.5649](#) [11.04.5818](#) [12.03.3130](#) [11.02.8322](#)  
[11.02.8825](#) [11.01.5860](#) [11.09.4338](#) [11.09.4359](#) [12.03.3129](#) [21.15.2630](#)