USER MANUAL

PAX2D – 1/8 DIN DIGITAL INPUT PANEL METER



SAFETY SUMMARY

All safety related regulations, local codes and instructions that appear in this literature or on equipment must be observed to ensure personal safety and to prevent damage to either the instrument or equipment connected to it. If equipment is used in a manner not specified by the manufacturer, the protection provided by the equipment may be impaired. Do not use this unit to directly command motors, valves, or other actuators not equipped with safeguards. To do so can be potentially harmful to persons or equipment in the event of a fault to the unit.

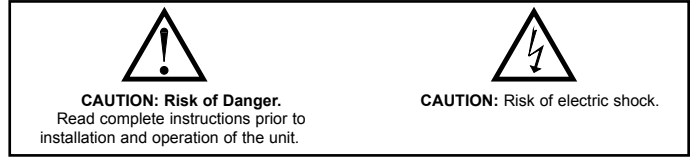

TABLE OF CONTENTS

Ordering Information	4
Using This Manual	5
Crimson Programming Software	5
General Meter Specifications	6
Option Cards	7
1.0 Installing the Meter	8
2.0 Setting the DIP Switches	8
3.0 Installing Option Cards	9
4.0 Wiring the Meter	9
5.0 Front Panel Keys And Display Overview	11
Line 2 Display Loops	12
6.0 Programming The PAX2D	12
6.1 Input Parameters (<i>I NPUT</i>)	13
6.2 Output Parameters (<i>OUT PUT</i>)	20
6.3 Display Parameters (<i>di SPLAY</i>)	24
6.4 Communications Port Parameters (<i>Port</i>)	27
Serial Communications Overview	28
PAX2D Frequently Used Modbus Registers	29
6.5 Factory Service Operations (<i>FACt r y</i>)	33
Troubleshooting	34
PAX2D Programming Quick Overview	38

ORDERING INFORMATION

Meter Part Numbers

MODEL NO.	DESCRIPTION	PART NUMBER
PAX2D	Digital Input Panel Meter	PAX2D000

Option Card and Accessories Part Numbers

TYPE	MODEL NO.	DESCRIPTION	PART NUMBER
Option Cards	PAXCDS	Dual Setpoint Relay Output Card	PAXCDS10
		Quad Setpoint Relay Output Card	PAXCDS20
		Quad Setpoint Sinking Open Collector Output Card	PAXCDS30
		Quad Setpoint Sourcing Open Collector Output Card	PAXCDS40
		Dual Triac/Dual SSR Drive Digital Output Card	PAXCDS50
		Quad Form C Relay Digital Output Card	PAXCDS60 *
	PAXCDC ¹	RS485 Serial Communications Card with Terminal Block	PAXCDC10
		Extended RS485 Serial Communications Card with Dual RJ11 Connector	PAXCDC1C
		RS232 Serial Communications Card with Terminal Block	PAXCDC20
		Extended RS232 Serial Communications Card with 9 Pin D Connector	PAXCDC2C
		DeviceNet Communications Card	PAXCDC30
		Profibus-DP Communications Card	PAXCDC50
	PAXCDL	Analog Output Card	PAXCDL10
Accessories	CBLUSB	USB Programming Cable Type A-Mini B	CBLUSB01
	RCP	Replacement Case with knock-out features.	RCPX2H00

Notes:

¹. For Modbus communications use RS485 Communications Output Card and configure communication (TYPE) parameter for Modbus.

* This card is not suitable for use in older PAX2 models. For proper installation, 3 case knock-out features must be present on the top case surface. To update a case to include these knock-outs, a replacement case is available.

USING THIS MANUAL

This manual contains installation and programming instructions for the PAX2D and all applicable option cards. To make installing the option card easier, it is recommended to use the Installation Guide provided with the card.

Only the portions of this manual that apply to the application need to be read. Minimally, we recommend that General Specifications, Reviewing the Front Buttons and Display, and Crimson® Programming Software portions of this manual be read in their entirety.

We recommend that unit programming be performed using Crimson programming software. When using Crimson, the programming portion of this manual serves as an overview of the programming options that are available through Crimson. The programming section of the manual will serve to provide expanded explanations of some of the PAX2D programming features found in Crimson. For users who do not intend to use Crimson to program their unit, this

manual includes information to provide for a user to program one, or all, of the programming parameters using the unit's keypad.

To find information regarding a specific topic or mnemonic, it is recommended that the manual be viewed on a computer and the "find" function be used. The alternate method of finding information is to identify the programming parameter involved and review the information contained in the section of the manual that pertains to that parameter.

CRIMSON PROGRAMMING SOFTWARE

Crimson® software is a Windows® based program that allows configuration of the PAX® from a PC. Crimson offers standard drop-down menu commands, that make it easy to program the unit. The unit's program can then be saved in a PC file for future use.

PROGRAMMING USING CRIMSON:

Crimson is included on the Flash Drive that is shipped with the PAX2. Check for updates to Crimson at <http://www.redlion.net/crimson2>.

- Install Crimson. Follow the installation instructions provided by the source from which Crimson is being downloaded or installed.
- Using a USB Type A-Mini B cable, plug the Mini B end of the cable into the PAX2 USB Programming Port.
- Plug the other end of the USB cable into an available USB port on the PC.
- Apply power to the PAX2. See Troubleshooting, on page 34, for error message resolution.
- Start Crimson.
- Click the Crimson "Link" tab.
- Click "Extract..."
 - o Crimson will extract the current program settings from the PAX2.
 - o If the PAX2 has not been programmed, the extracted file will contain factory settings. Note that the PAX2 factory settings vary based on the option cards installed.
- A programming selection screen will appear. Double click on an applicable programming selection and make program specific parameter selections. When completed, click "Close" and continue selecting applicable programming selections and making appropriate parameter selections. Continue until all necessary programming parameters have been configured.
- When all programming selections have been made, save the configuration file.
- Download the configuration file to the PAX2 by clicking the "Link" tab and selecting "Update".

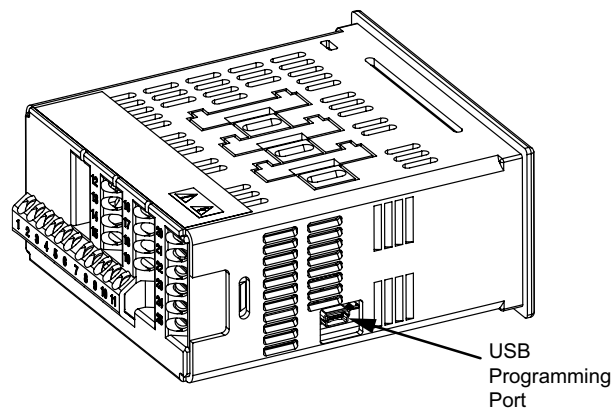

GENERAL METER SPECIFICATIONS

1. **DISPLAY:** Negative image LCD
 Top Line - 6 digit, 0.71" (18 mm), with tri-color backlight (red, green or orange), display range: -199,999 to 999,999;
 Bottom Line - 9 digit, 0.35" (8.9 mm), with green backlight, display range: -199,999,999 to 999,999,999

2. **POWER:**
 AC Power: 40 to 250 VAC, 50/60 Hz, 20 VA
 DC Power: 21.6 to 250 VDC, 8 W
 Isolation: 2300 Vrms for 1 min. to all inputs and outputs.

3. **SENSOR POWER:** +18 VDC, $\pm 5\%$ @ 60 mA max., short circuit protected

4. **ANNUNCIATORS:**
 Line 1 Units Display – Programmable 3 digit units annunciator with tri-color backlight (red, green or orange)
 Setpoint Output Status Indicators - Red backlight color

- 1 - Setpoint 1 output
- 2 - Setpoint 2 output
- 3 - Setpoint 3 output
- 4 - Setpoint 4 output

5. **KEYPAD:** 2 programmable function keys, 4 keys total
 6. **COUNTER DISPLAYS:** 6-digit (top line) or 9-digit (bottom line)

Top Line Display Range: -199,999 to 999,999
 Bottom Line Display Range: -199,999,999 to 999,999,999
 Over Range Display: $\overline{00Er}$
 Under Range Display: $\underline{00Er}$
 Display Designators: $\overline{E} \overline{t} \overline{R}$, $\overline{E} \overline{t} \overline{b}$, $\overline{E} \overline{t} \overline{L}$ (top line), \overline{R} , \overline{b} , \overline{L} (bottom line)
 Maximum Count Rates: 50% duty cycle, count mode dependent
 If setpoints disabled: 35 KHz for all modes except Quadrature x4 (32 KHz)
 If setpoint(s) enabled: 20 KHz for any mode except Quadrature x1 (19 KHz), Quadrature x2 (17 KHz) and Quadrature x4 (10 KHz)

7. **RATE DISPLAYS:** 6-digit (top or bottom line)
 Rate A or Rate B Display Range: 0 to 999,999
 Rate C, Rate Max (High) or Min (Low) Display Range: -199,999 to 999,999
 Over Range Display: $\overline{00Er}$
 Under Range Display: $\underline{00Er}$
 Display Designators: $\overline{R} \overline{t} \overline{R}$, $\overline{R} \overline{t} \overline{b}$, $\overline{R} \overline{t} \overline{L}$, $\overline{H} \overline{t}$, $\overline{L} \overline{t}$ (top or bottom line)
 Maximum Frequency: 50 KHz
 Minimum Frequency: 0.001 Hz
 Display Update Time: 0.1 to 999.9 seconds
 Accuracy: $\pm 0.01\%$

8. **SIGNAL INPUTS (INPUT A and INPUT B):**
 See Section 2.0 Setting the DIP Switches for complete input specifications.
 DIP switch selectable inputs accept pulses from a variety of sources including switch contacts, TTL outputs, magnetic pickups and all standard RLC sensors. Inputs accept current sinking or current sourcing outputs and provide selectable input filtering for low frequency signals or switch contact debounce.

DUAL COUNT MODES:

When any dual count mode is used, then User Inputs 1 and/or 2 will accept the second signal of each signal pair. The user inputs do not have the Logic/Mag, HI/LO Freq, and Sink/Source input setup switches. The user inputs are inherently a logic input with no low frequency filtering. Any mechanical contacts used for these inputs in a dual count mode must be debounced externally. The user input may only be selected for sink/source by the User Input Active parameter ($USrAct$).

9. **USER INPUTS:** Three programmable user inputs
 Max. Continuous Input: 30 VDC
 Isolation To Sensor Input Common: Not isolated.
 Response Time: 12 msec. max.
 Logic State: User Selectable for sinking (active low) or sourcing (active high)

INPUT STATE	SINKING INPUTS	SOURCING INPUTS
Active	20K Ω pull-up to +3.3V $V_{IN} < 1.1$ VDC	20K Ω pull-down $V_{IN} > 2.2$ VDC
Inactive	$V_{IN} > 2.2$ VDC	$V_{IN} < 1.1$ VDC

10. **PRESCALER OUTPUT:**
 NPN Open Collector: $I_{SNK} = 100$ mA max. @ $V_{OL} = 1$ VDC max. $V_{OH} = 30$ VDC max. Duty cycle 25% min. and 50 % max.

11. **MEMORY:** Nonvolatile memory retains all programmable parameters and count values when power is removed.

12. **ENVIRONMENTAL CONDITIONS:**
 Operating Temperature Range: 0 to 50 °C
 Storage Temperature Range: -40 to 60 °C
 Vibration to IEC 68-2-6: Operational 5-150 Hz, 2 g
 Shock to IEC 68-2-27: Operational 25 g (10 g relay)
 Operating and Storage Humidity: 0 to 85% max. RH non-condensing
 Altitude: Up to 2000 meters

13. **CERTIFICATIONS AND COMPLIANCES:**
CE Approved
 EN 61326-1 Immunity to Industrial Locations
 Emission CISPR 11 Class A
 IEC/EN 61010-1
 RoHS Compliant
 UL Listed: File #E179259
 Type 4X Indoor Enclosure rating (Face only)
 IP65 Enclosure rating (Face only)
 IP20 Enclosure rating (Rear of unit)
Refer to EMC Installation Guidelines section of the bulletin for additional information.

14. **CONNECTIONS:** High compression cage-clamp terminal block
 Wire Strip Length: 0.3" (7.5 mm)
 Wire Gauge Capacity: 26 to 16 AWG (0.14 to 1.5 mm²)
 Torque: 4.4-5.3 inch-lbs (0.5-0.6 N-m)

15. **CONSTRUCTION:** This unit is rated Type 4X/IP65 for indoor use only. IP20 Touch safe. Installation Category II, Pollution Degree 2. One piece bezel/ case. Flame resistant. Synthetic rubber keypad. Panel gasket and mounting clip included.

16. **WEIGHT:** 8 oz. (226.8 g)

DIMENSIONS In inches (mm)

Note: Recommended minimum clearance (behind the panel) for mounting clip installation is 2.1" (53.4) H x 5.5" (140) W.

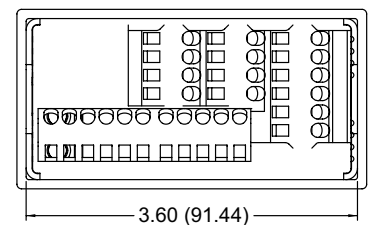
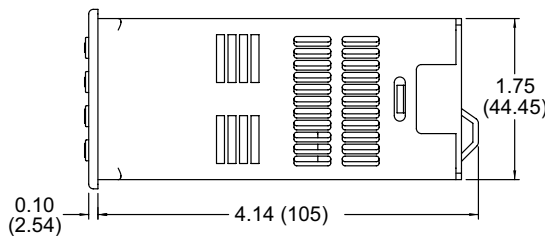
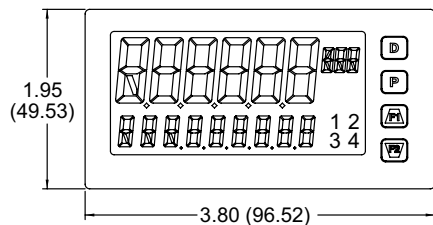

OPTION CARDS



WARNING: Disconnect all power to the unit before installing option cards.

Adding Option Cards

The PAX2 can be fitted with up to three option cards. The details for each option card can be reviewed in the specification section below. Only one card from each function type can be installed at a time. The function types include Setpoint Alarms (PAXCDS), Communications (PAXCDC), and Analog Output (PAXCDL). The option cards can be installed initially or at a later date.

COMMUNICATION CARDS (PAXCDC)

A variety of communication protocols are available for the PAX2. Only one PAXCDC card can be installed at a time. *Note: For Modbus communications use RS485 Communications Output Card and configure communication (TYPE) parameter for Modbus.*

SERIAL COMMUNICATIONS CARD: PAXCDC1_ and PAXCDC2_

Type: RS485 or RS232

Communication Type: Modbus ASCII, RLC Protocol (ASCII), and Modbus RTU

Isolation To Sensor & User Input Commons: 500 Vrms for 1 min.
Not Isolated from all other commons.

Data: 7/8 bits

Baud: 1200 to 38,400

Parity: no, odd or even

Bus Address: Selectable 0 to 99 (RLC Protocol), or 1 to 247 (Modbus Protocol), Max. 32 meters per line (RS485)

Transmit Delay: Selectable for 0 to 0.250 sec (+2 msec min)

DEVICENET™ CARD: PAXCDC30

Compatibility: Group 2 Server Only, not UCMM capable

Baud Rates: 125 Kbaud, 250 Kbaud, and 500 Kbaud

Bus Interface: Phillips 82C250 or equivalent with MIS wiring protection per DeviceNet™ Volume I Section 10.2.2.

Node Isolation: Bus powered, isolated node

Host Isolation: 500 Vrms for 1 minute between DeviceNet™ and unit input common.

PROFIBUS-DP CARD: PAXCDC50

Fieldbus Type: Profibus-DP as per EN 50170, implemented with Siemens SPC3 ASIC

Conformance: PNO Certified Profibus-DP Slave Device

Baud Rates: Automatic baud rate detection in the range 9.6 Kbaud to 12 Mbaud

Station Address: 0 to 125, set by rotary switches.

Connection: 9-pin Female D-Sub connector

Network Isolation: 500 Vrms for 1 minute between Profibus network and sensor and user input commons. Not isolated from all other commons.

SETPOINT CARDS (PAXCDS)

The PAX2 has 6 available setpoint alarm output option cards. Only one PAXCDS card can be installed at a time. (Logic state of the outputs can be reversed in the programming.) These option cards include:

DUAL RELAY CARD: PAXCDS10

Type: Two FORM-C relays

Isolation To Sensor & User Input Commons: 2000 Vrms for 1 min.

Contact Rating:

One Relay Energized: 5 amps @ 120/240 VAC or 28 VDC (resistive load).

Total current with both relays energized not to exceed 5 amps

Life Expectancy: 100 K cycles min. at full load rating. External RC snubber extends relay life for operation with inductive loads

QUAD RELAY CARD: PAXCDS20

Type: Four FORM-A relays

Isolation To Sensor & User Input Commons: 2300 Vrms for 1 min.

Contact Rating:

One Relay Energized: 3 amps @ 240 VAC or 30 VDC (resistive load).

Total current with all four relays energized not to exceed 4 amps

Life Expectancy: 100K cycles min. at full load rating. External RC snubber extends relay life for operation with inductive loads

QUAD SINKING OPEN COLLECTOR CARD: PAXCDS30

Type: Four isolated sinking NPN transistors.

Isolation To Sensor & User Input Commons: 500 Vrms for 1 min.
Not Isolated from all other commons.

Rating: 100 mA max @ $V_{SAT} = 0.7$ V max. $V_{MAX} = 30$ V

QUAD SOURCING OPEN COLLECTOR CARD: PAXCDS40

Type: Four isolated sourcing PNP transistors.

Isolation To Sensor & User Input Commons: 500 Vrms for 1 min.
Not Isolated from all other commons.

Rating: Internal supply: 18 VDC unregulated, 30 mA max. total
External supply: 30 VDC max., 100 mA max. each output

DUAL TRIAC/DUAL SSR DRIVE CARD: PAXCDS50

Triac:

Type: Isolated, zero crossing detection

Voltage: 260 VAC max., 20 VAC min.

Max Load Current: 1 Amp @ 25°C
0.75 Amp @ 50°C

Total load current with both triacs ON not to exceed 1.5 Amps

Min Load Current: 5 mA

Off State Leakage Current: 1 mA max @ 60 Hz

Operating Frequency: 20-400 Hz

SSR Drive:

Type: Two isolated sourcing PNP Transistors.

Isolation To Sensor & User Input Commons: 500 Vrms for 1 min.
Not Isolated from all other commons.

Rating:

Output Voltage: 18/24 VDC (unit dependent) $\pm 10\%$, 30 mA max.
total both outputs

QUAD FORM C RELAY CARD: PAXCDS60

Type: Four FORM-C relays

Isolation To Sensor & User Input Commons: 500 Vrms for 1 min.

Contact Rating:

Rated Load: 3 Amp @ 30 VDC/125 VAC

Total Current With All Four Relays Energized not to exceed 4 amps

Life Expectancy: 100 K cycles min. at full load rating. External RC snubber extends relay life for operation with inductive loads

LINEAR DC OUTPUT (PAXCDL)

Either a 0(4)-20 mA or 0-10 V retransmitted linear DC output is available from the analog output option card. The programmable output low and high scaling can be based on various display values. Reverse slope output is possible by reversing the scaling point positions.

ANALOG OUTPUT CARD: PAXCDL10

Types: 0 to 20 mA, 4 to 20 mA or 0 to 10 VDC

Isolation To Sensor & User Input Commons: 500 Vrms for 1 min.
Not Isolated from all other commons.

Accuracy: 0.17% of FS (18 to 28 °C); 0.4% of FS (0 to 50 °C)

Resolution: 1/3500

Compliance: 10 VDC: 10 K Ω load min., 20 mA: 500 Ω load max.

Powered: Self-powered

Response Time: 50 msec max., 10 msec typical

1.0 INSTALLING THE METER

Installation

The PAX2 meets Type 4X/IP65 requirements when properly installed. The unit is intended to be mounted into an enclosed panel. Prepare the panel cutout to the dimensions shown. Remove the panel latch from the unit. Slide the panel gasket over the rear of the unit to the back of the bezel. The unit should be installed fully assembled. Insert the unit into the panel cutout.

While holding the unit in place, push the panel latch over the rear of the unit so that the tabs of the panel latch engage in the slots on the case. The panel latch should be engaged in the farthest forward slot possible. To achieve a proper seal, tighten the latch screws evenly until the unit is snug in the panel (Torque to approximately 7 in-lbs [79N-cm]). Do not over-tighten the screws.

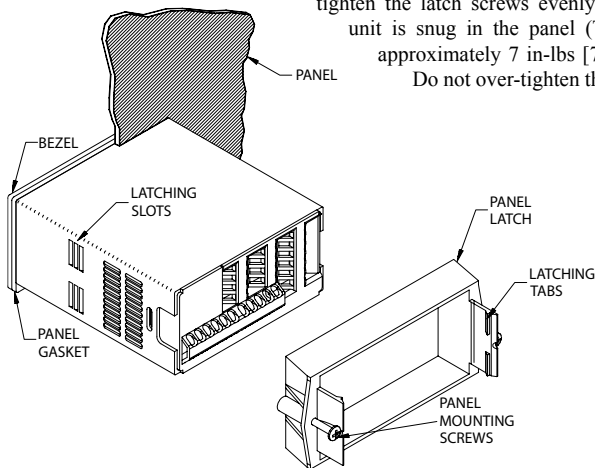

Installation Environment

The unit should be installed in a location that does not exceed the operating temperature and provides good air circulation. Placing the unit near devices that generate excessive heat should be avoided.

The bezel should only be cleaned with a soft cloth and neutral soap product. Do NOT use solvents. Continuous exposure to direct sunlight may accelerate the aging process of the bezel.

Do not use tools of any kind (screwdrivers, pens, pencils, etc.) to operate the keypad of the unit.

PANEL CUT-OUT

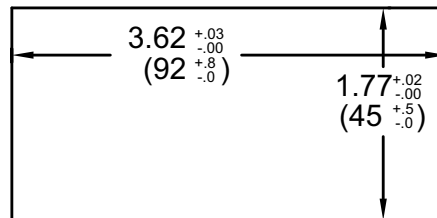

2.0 SETTING THE DIP SWITCHES

To access the switches, remove the unit base from the case by firmly squeezing and pulling back on the side rear finger tabs. This should lower the latch below the case slot (which is located just in front of the finger tabs). It is recommended to release the latch on one side, then start the other side latch.



Warning: Exposed line voltage exists on the circuit boards. Remove all power to the unit AND load circuits before removing the unit from its case.

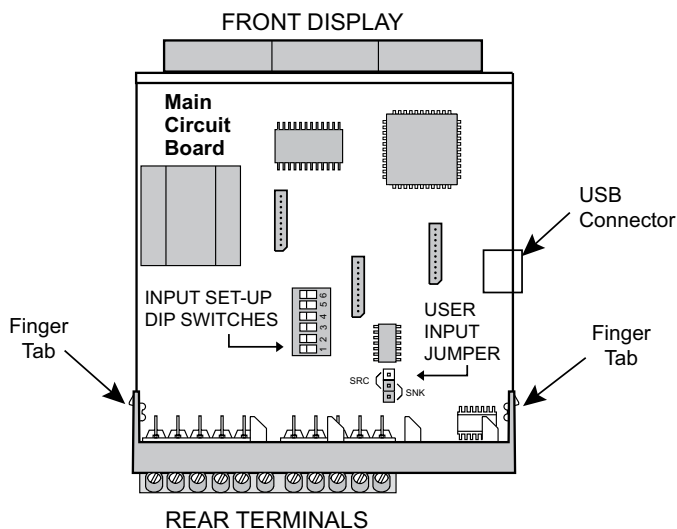

SETTING THE INPUT DIP SWITCHES

The unit has six DIP switches for Input A and Input B terminal set-up that must be set before applying power.

Input B LO Freq.	<input type="checkbox"/>	6	HI Freq.
Input B SRC.	<input type="checkbox"/>	5	SNK.
Input B MAG.	<input type="checkbox"/>	4	Logic
Input A LO Freq.	<input type="checkbox"/>	3	HI Freq.
Input A SRC.	<input type="checkbox"/>	2	SNK.
Input A MAG.	<input type="checkbox"/>	1	Logic
	ON		

■ Factory Setting

SWITCHES 1 and 4

LOGIC: Input trigger levels $V_{IL} = 1.5$ V max.; $V_{IH} = 3.75$ V min.
MAG: 200 mV peak input sensitivity; 100 mV hysteresis; maximum voltage: ± 40 V peak (28 Vrms); Input impedance: 3.9 K Ω @ 60 Hz; Must also have SRC switch ON. (Not recommended with counting applications.)

SWITCHES 2 and 5

SNK.: Adds internal 7.8 K Ω pull-up resistor to +5 VDC, $I_{MAX} = 0.7$ mA.
SRC.: Adds internal 3.9 K Ω pull-down resistor, 7.3 mA max. @ 28 VDC, $V_{MAX} = 30$ VDC.

SWITCHES 3 and 6

HI Frequency: Removes damping capacitor and allows max. frequency.
LO Frequency: Adds a damping capacitor for switch contact bounce. Also limits input frequency to maximum 50 Hz and input pulse widths to minimum 10 msec.

3.0 INSTALLING OPTION CARDS

The option cards are separately purchased cards that perform specific functions. These cards plug into the main circuit board of the unit. The option cards have many unique functions when used with the PAX2.



CAUTION: The option card and main circuit board contain static sensitive components. Before handling the cards, discharge static charges from your body by touching a grounded bare metal object. Ideally, handle the cards at a static controlled clean workstation. Also, only handle the cards by the edges. Dirt, oil or other contaminants that may contact the cards can adversely affect circuit operation.

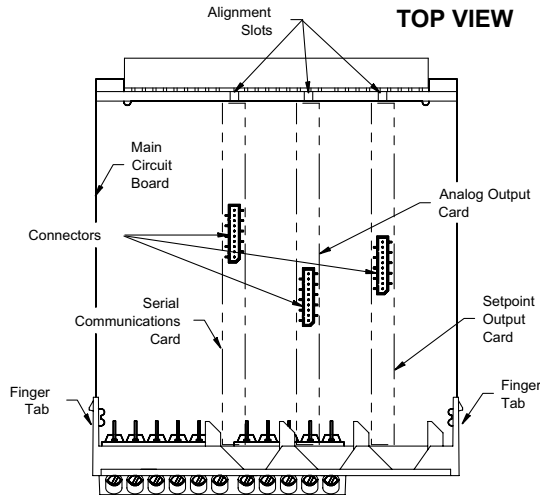

WARNING: Exposed line voltage exists on the circuit boards. Remove all power to the unit AND load circuits before removing the unit from its case.

To Install:

1. For option card specific installation instructions, see the installation instructions provided with the option card being installed.
2. When handling the main circuit board, hold it by the rear cover. When handling the option card, hold it by the terminal block.
3. Remove the main assembly from the rear of the case by squeezing both finger holds on the rear cover and pulling the assembly out of the case. Or use a small screwdriver to depress the side latches and pull the main assembly out of the case. Do not remove the rear cover from the main circuit board.
4. Locate the appropriate option card slot location on the main circuit board. Align the option card terminal block with the slot terminal block position on the rear cover. Align the option card connector with the main circuit board option card connector and then press to fully engage the connector. Verify the tab on the option card rests in the alignment slot on the display board.
5. If installing an option card that includes a terminal block on the top of the option card, a knock-out on the top of the PAX case will need to be removed to allow the top terminal block to be inserted later. Locate the  shaped knock-out that aligns with the option slot for which the option card is being installed. Carefully remove the knock-out, being careful not to remove additional knock-outs. Trim knock-out tabs (gates) that remain on the case. The top terminal block on the option card will need to be removed before completing step 6.
6. Slide the assembly back into the case. Be sure the rear cover latches engage in the case. If option card includes a top terminal block, install top terminal block at this time.

4.0 WIRING THE METER

WIRING OVERVIEW

Electrical connections are made via screw-clamp terminals located on the back of the unit. All conductors should conform to the meter's voltage and current ratings. All cabling should conform to appropriate standards of good installation, local codes and regulations. It is recommended that the power supplied to the unit (DC or AC) be protected by a fuse or circuit breaker.

When wiring the unit, compare the numbers embossed on the back of the unit case against those shown in wiring drawings for proper wire position. Strip the wire, according to the terminal block specifications (stranded wires should be tinned with solder). Insert the lead into the correct terminal and then tighten the terminal until the wire is secure (Pull wire to verify tightness).

EMC INSTALLATION GUIDELINES

Although Red Lion Controls Products are designed with a high degree of immunity to Electromagnetic Interference (EMI), proper installation and wiring methods must be followed to ensure compatibility in each application. The type of the electrical noise, source or coupling method into a unit may be different for various installations. Cable length, routing, and shield termination are very important and can mean the difference between a successful or troublesome installation. Listed are some EMI guidelines for a successful installation in an industrial environment.

1. A unit should be mounted in a metal enclosure, which is properly connected to protective earth.
2. Use shielded cables for all Signal and Control inputs. The shield connection should be made as short as possible. The connection point for the shield depends somewhat upon the application. Listed below are the recommended methods of connecting the shield, in order of their effectiveness.
 - a. Connect the shield to earth ground (protective earth) at one end where the unit is mounted.
 - b. Connect the shield to earth ground at both ends of the cable, usually when the noise source frequency is over 1 MHz.
3. Never run Signal or Control cables in the same conduit or raceway with AC power lines, conductors, feeding motors, solenoids, SCR controls, and heaters, etc. The cables should be run through metal conduit that is properly grounded. This is especially useful in applications where cable runs are long and portable two-way radios are used in close proximity or if the installation

is near a commercial radio transmitter. Also, Signal or Control cables within an enclosure should be routed as far away as possible from contactors, control relays, transformers, and other noisy components.

4. Long cable runs are more susceptible to EMI pickup than short cable runs.
5. In extremely high EMI environments, the use of external EMI suppression devices such as Ferrite Suppression Cores for signal and control cables is effective. The following EMI suppression devices (or equivalent) are recommended:

Fair-Rite part number 0443167251 (RLC part number FCOR0000)

Line Filters for input power cables:

Schaffner # FN2010-1/07 (Red Lion Controls # LFIL0000)

6. To protect relay contacts that control inductive loads and to minimize radiated and conducted noise (EMI), some type of contact protection network is normally installed across the load, the contacts or both. The most effective location is across the load.

- a. Using a snubber, which is a resistor-capacitor (RC) network or metal oxide varistor (MOV) across an AC inductive load is very effective at reducing EMI and increasing relay contact life.
- b. If a DC inductive load (such as a DC relay coil) is controlled by a transistor switch, care must be taken not to exceed the breakdown voltage of the transistor when the load is switched. One of the most effective ways is to place a diode across the inductive load. Most RLC products with solid state outputs have internal zener diode protection. However external diode protection at the load is always a good design practice to limit EMI. Although the use of a snubber or varistor could be used.

RLC part numbers: Snubber: SNUB0000

Varistor: ILS11500 or ILS23000

7. Care should be taken when connecting input and output devices to the instrument. When a separate input and output common is provided, they should not be mixed. Therefore a sensor common should NOT be connected to an output common. This would cause EMI on the sensitive input common, which could affect the instrument's operation.

Visit RLC's web site at <http://www.redlion.net/emi> for more information on EMI guidelines, Safety and CE issues as they relate to Red Lion Controls products.

4.1 POWER WIRING

AC Power

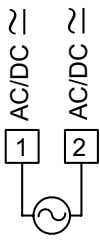

DC Power

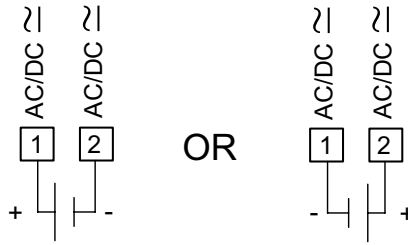

The power supplied to the unit shall employ a 15 Amp UL approved circuit breaker for AC input and a 1 Amp, 250 V UL approved fuse for DC input. It shall be easily accessible and marked as a disconnecting device to the installed unit. This device is not directly intended for connection to the mains without a reliable means to reduce transient over-voltages to 1500 V.

4.2 INPUT SIGNAL WIRING



CAUTION: Sensor input common is NOT isolated from user input common. In order to preserve the safety of the unit application, the sensor input common must be suitably isolated from hazardous live earth referenced voltage; or input common must be at protective earth ground potential. If not, hazardous voltage may be present at the User Inputs and User Input Common terminals. Appropriate considerations must then be given to the potential of the user input common with respect to earth ground; and the common of the isolated option cards with respect to input common.

If you are wiring Input B, connect signal to Terminal 6 instead of 5, and set DIP switches 4, 5, and 6 to the positions shown for 1, 2, and 3.

<p>Magnetic Pickup</p>	<p>AC Inputs From Tach Generators, Etc.</p>	<p>Two Wire Proximity, Current Source</p>
<p>Current Sinking Output</p>	<p>Current Sourcing Output</p>	<p>Interfacing With TTL</p>
<p>Switch or Isolated Transistor; Current Sink</p>	<p>Switch or Isolated Transistor; Current Source</p>	<p>Emitter Follower; Current Source</p>
<p>Quad; Current Sink Output</p> <p>If using single Counter B, then wire signal to 6, and Quad/Direction to 9. Set switches as shown.</p>	<p>Dual Quad/Count; Current Sink Output</p>	<p>Dual Quad/Quad; Current Sink Output</p>

Shaded areas not recommended for counting applications.

4.3 USER INPUT WIRING

If User Input 1 and/or 2 are wired for quadrature or directional counting, an additional switching device should not be connected to that User Input terminal. User Input terminal does not need to be wired in order to remain in inactive state.

Sinking Logic (USER1 LO)

When the USER1 parameter is programmed to LO, the user inputs are internally pulled up to +3.3 V with 20 KΩ resistance. The input is active when it is pulled low (<1.1 V).

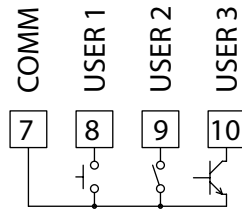

Sourcing Logic (USER1 HI)

When the USER1 parameter is programmed to HI, the user inputs are internally pulled down to 0 V with 20 KΩ resistance. The input is active when a voltage greater than 2.2 VDC is applied.

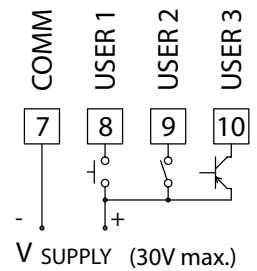

4.4 SETPOINT (ALARMS) WIRING

4.5 SERIAL COMMUNICATION WIRING

4.6 ANALOG OUTPUT WIRING

See appropriate option card bulletin for wiring details.

4.7 PRESCALER OUTPUT WIRING (NPN O.C.)

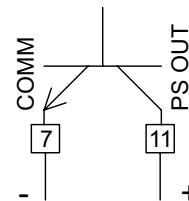

5.0 FRONT PANEL KEYS AND DISPLAY OVERVIEW

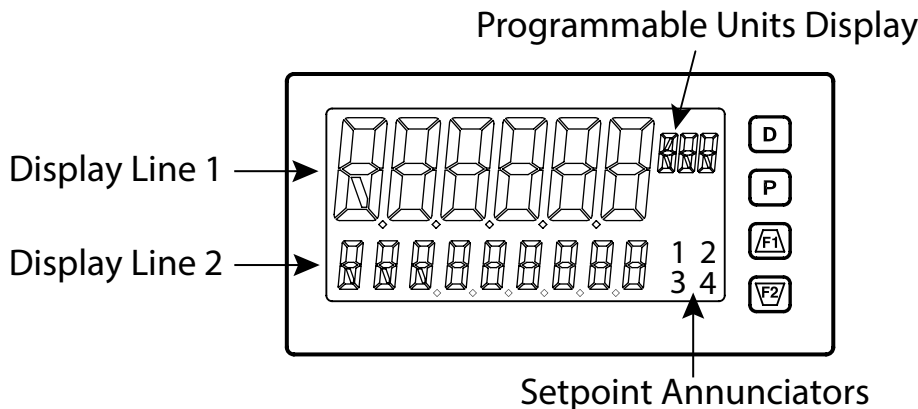

KEY DISPLAY MODE OPERATION

- D** Index through enabled Line 2 display values
- P** Enter full programming mode or access the parameter and hidden display loops; Press and hold to skip parameters and go directly to Code or Programming Menu
- F1** User programmable Function key 1; hold for 3 seconds for user programmable second function 1
Index through enabled Line 1 values (factory setting)
- F2** User programmable Function key 2; hold for 3 seconds for user programmable second function 2
Reset Line 1 (factory setting)

PROGRAMMING MODE OPERATION

- Return to the previous menu level (momentary press)
Quick exit to Display Mode (press and hold)
- Access the programming parameter menus, store selected parameter and index to next parameter
- Increment selected parameter value; Hold **F1** and momentarily press **F2** key to increment next decade or **D** key to increment by 1000's
- Decrement selected parameter value; Hold **F2** and momentarily press **F1** key to decrement next decade or **D** key to decrement by 1000's

DISPLAY LINE 1

Line 1 is the large, 6-digit top line display. Counter values, rate values and the maximum (Hi) and minimum (Lo) rate capture values can be shown on Line 1. The 3-digit Units mnemonic characters can be used to indicate which Line 1 display value is shown. Standard or custom mnemonics are available for the Line 1 values. See Line 1 parameters in the Display Parameters programming section for configuration details.

DISPLAY LINE 2

Line 2 is the smaller, 9-digit bottom line display. Counter values, rate values, rate capture values, setpoint values and parameter List A/B status can all be shown on the Line 2 display. The display loops described below are used to view, reset and modify the selected display values, based on the Line 2 Value Access setting programmed for each available value. See Line 2 parameters in the Display Parameters programming section for configuration details.

LINE 2 DISPLAY LOOPS

The PAX2D offers three display loops to allow users quick access to needed information.

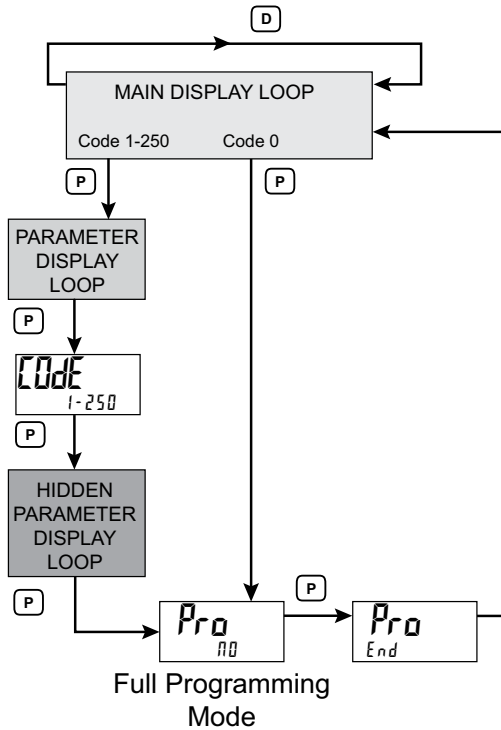

Main Display Loop

In the Main display loop, the D key is pressed to sequence through the selected Line 2 values. A left justified 2 or 3-character mnemonic indicates which Line 2 value is currently shown. When in the Main display loop, the Function keys $\overline{F1}$ and $\overline{F2}$ perform the user functions programmed in the User Input parameter section.

Parameter and Hidden Parameter Display Loops

These Display loops provide quick access to selected parameters that can be viewed and modified on Line 2 without having to enter Full Programming mode. These values include Parameter List A/B selection, setpoints, scale factors, counter load values and display (color, intensity and contrast) settings. To utilize the Parameter or Hidden Parameter Display Loops, a security code (1-250) must be programmed. (See Programming Security Code in the Display Parameters programming section for details.)

The Parameter Display Loop is accessed by pressing the P key. The selected Parameter Display Loop values can be viewed and/or changed per the Line 2 Value Access setting programmed for each available value. The Hidden Parameter Display Loop follows the Parameter display loop, and can only be accessed when the correct security code is entered at the Code prompt. Combining the two parameter loops provides an area for parameters that require general access and/or protected or secure access depending on the application needs.

While in the Parameter and Hidden Parameter loops, pressing the D key will return the unit to the Main Display Loop. To directly access the Code prompt, press and hold the P key. This can be done from the Main display loop or at any point during the Parameter display loop. Also, to directly access Full Programming mode while in the Hidden Parameter loop, press and hold the P key to bypass any remaining Hidden Parameter loop values.

6.0 PROGRAMMING THE PAX2D

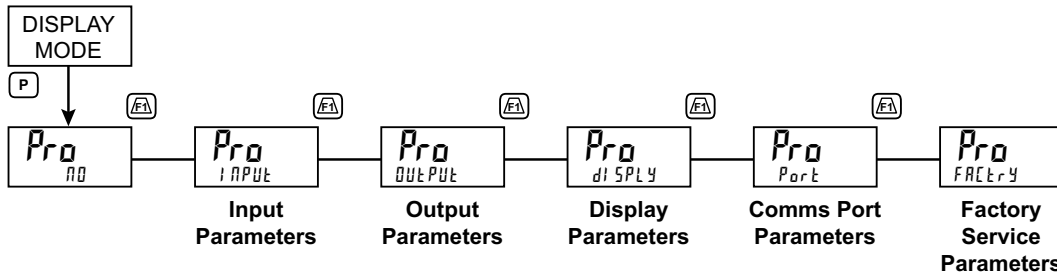

It is recommended that program settings be recorded as programming is performed. A blank Parameter Value Chart is provided at the end of this bulletin.

PROGRAMMING MODE ENTRY

The Programming Mode is entered by pressing the P key. Full Programming Mode will be accessible unless the unit is programmed to use the Parameter loop or Hidden Parameter loop on the Line 2 display. In this case, programming access will be limited by a security code and/or a hardware program lock. (Refer to the previous section for details on Line 2 display loops and limited programming access.) Full Programming Mode permits all parameters to be viewed and modified. In this mode, the front panel keys change to Programming Mode Operations and certain user input functions are disabled.

MODULE ENTRY

The Programming Menu is organized into five modules. These modules group together parameters that are related in function. The $\overline{F1}$ and $\overline{F2}$ keys are used to select the desired module. The displayed module is entered by pressing the P key.

MODULE MENU

Upon entering a module, a parameter selection sub-menu is provided to choose the specific parameter type for programming. For example, this includes counter, rate and user input under the Input Parameter menu. Use the $\overline{F1}$ and $\overline{F2}$ keys to select the desired parameter type, and press the P key to enter the parameter menu.

PARAMETER MENU

Upon entering the Parameter Menu, the P key is pressed to advance to a specific parameter to be changed. After completing the parameter menu, or upon pressing the D key, the display returns to the initial entry point for the parameter menu. For each additional press of the D key, the display returns to the previous level within the module until exiting the module entirely.

SELECTION/VALUE ENTRY

For each parameter, the top line display shows the parameter while the bottom line shows the selections/value for that parameter. The $\overline{F1}$ and $\overline{F2}$ keys are used to move through the selections/values for the parameter. Pressing the P key, stores and activates the displayed selection/value. This also advances the unit to the next parameter.

Numerical Value Entry

If the parameter is programmed for enter (Ent r), the $\overline{F1}$ and $\overline{F2}$ keys are used to change the parameter values in any of the display loops.

The $\overline{F1}$ and $\overline{F2}$ keys will increment or decrement the parameter value. When the $\overline{F1}$ or $\overline{F2}$ key is pressed and held, the value automatically scrolls. The longer the key is held the faster the value scrolls.

For large value changes, press and hold the $\overline{F1}$ or $\overline{F2}$ key. While holding that key, momentarily press the opposite arrow key ($\overline{F2}$ or $\overline{F1}$) to shift decades (10's, 100's, etc), or momentarily press the D key and the value scrolls by 1000's as the arrow key is held. Releasing the arrow key removes the decade or 1000's scroll feature. The arrow keys can then be used to make small value changes as described above.

As an alternative, a Select and Set value entry method is provided. This can be used in combination with the value scrolling described above. To change the selected digit in the numerical value, press both the $\overline{F1}$ and $\overline{F2}$ keys simultaneously. The next digit to the left will be selected (flashing). If both keys are pressed and held, the selected digit will scroll from right to left until one or both keys are released.

Once a digit is selected, the arrow keys are used to increment or decrement that digit to the desired number.

PROGRAMMING MODE EXIT

To exit the Programming Mode, press and hold the **D** key (from anywhere in the Programming Mode) or press the **P** key with *PrO nO* displayed. This will commit any stored parameter changes to memory and return the unit to the Display Mode. If a parameter was just changed, the **P** key must be pressed to store the change before pressing the **D** key. (If power loss occurs before returning to the Display Mode, verify recent parameter changes.)

PROGRAMMING TIPS

It is recommended to start with the Input Parameters and proceed through each module in sequence. If lost or confused while programming, press and hold the **D** key to exit programming mode and start over. It is recommended that program settings be recorded as programming is performed. When programming is complete lock out programming with a user input or lock-out code.

Factory Settings may be completely restored in the Factory Service Operations module. This is useful when encountering programming problems.

6.1 INPUT PARAMETERS (INPUT)

INPUT SELECT



COUNT RATE USER

Select the Count, Rate or User Input to be programmed.

6.1.1 COUNTER INPUT PARAMETERS (COUNT)

This section details the programming for Counter A and the Prescaler Output, Counter B, and Counter C. For maximum input frequency, the counters not being used should be set to mode *nONE*. The Prescaler should be set to *nO* when it is not in use. When set to *nONE* or *nO*, the remaining related parameters are not accessible. A Select Parameter List feature for Scale Factors and Count Load values is explained in the User Input programming section.

In the display depictions shown in this section, "x" represents A, B, or C for the counter being programmed.

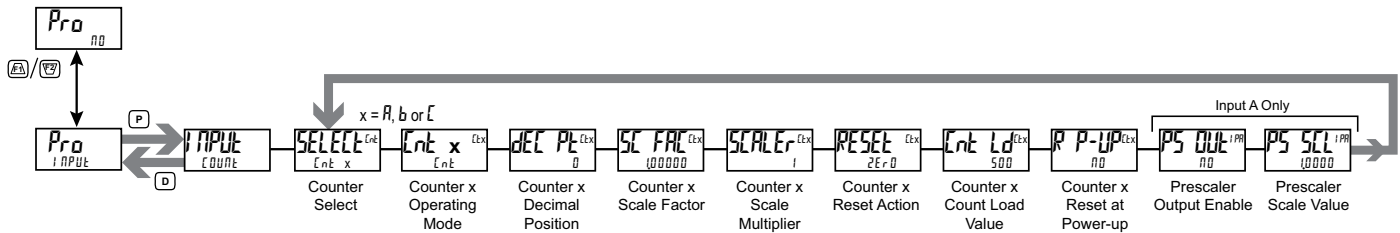

COUNTER SELECT



Cnt A Cnt b Cnt C

Select the Counter to be programmed.

COUNTER OPERATING MODE

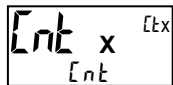

Choose the operating mode for the selected counter.

SELECTION	MODE	DESCRIPTION
qURd2	Quad X2	Adds Input A rising edge when Input B is high and Input A falling edge when Input B is low. Subtracts Input A falling edge when Input B is high and Input A rising edge when Input B is low.
qURd4	Quad X4	Adds Input A rising edge when Input B is high, Input A falling edge when Input B is low, Input B rising edge when Input A is high. Subtracts Input A falling edge when Input B is high, Input A rising edge when Input B is low, Input B rising edge when Input A is high, and Input B falling edge when Input A is low.
dqURd1	Dual Count Quad X1	Adds Input A rising edge when User 1 is high. Subtracts Input A falling edge when User 1 is high.
dqURd2	Dual Count Quad X2	Adds Input A rising edge when User 1 is high and Input A falling edge when User 1 is low. Subtracts Input A falling edge when User 1 is high and Input A rising edge when User 1 is low.
Cnt2	Count X2	Adds Input A rising and falling edges.
CntUd2	Count X2 w/direction	Adds Input A rising and falling edges if Input B is high. Subtracts Input A rising and falling edge if Input B is low.
dCtUd2	Dual Count X2 w/direction	Adds Input A rising and falling edges if User 1 is high. Subtracts Input A rising and falling edge if User 1 is low.

Counter A Selections

SELECTION	MODE	DESCRIPTION
nONE	None	Does not count.
Cnt	Count X1	Adds Input A falling edge.
CntUd	Count X1 w/direction	Adds Input A falling edge if Input B is high. Subtracts Input A falling edge if Input B is low.
dCntUd	Dual Count X1 w/direction	Adds Input A falling edge if User 1 is high. Subtracts Input A falling edge if User 1 is low.
AddAdd	Dual Input X1 Add/Add	Adds Input A falling edge and Input B falling edge.
AddSub	Dual Input X1 Add/Subtract	Adds Input A falling edge. Subtracts Input B falling edge.
qURd1	Quad X1	Adds Input A rising edge when Input B is high. Subtracts Input A falling edge when Input B is high

SCALING CALCULATION

Each counter has the ability to scale an input signal to a desired display value. This is accomplished by the counter mode (Cnt x), decimal point (DEC Pt), scale factor (SC FAc), and scale multiplier (SCALr). The scale factor is calculated using:

$$SF (SC FAc) = \frac{DDD}{(\text{Number of pulses per 'single' unit} \times CMF \times SM)}$$

Where:

Number of pulses per 'single' unit: pulses per unit generated by the process (i.e. # of pulses per foot)

CMF: Counter Mode (Cnt x) times factor of the mode 1, 2 or 4.

SM: Scale Multiplier (SCALr) selection of 10, 1, 0.1 or 0.01.

DDD: Desired Display Decimal (1 = 1, 1.0 = 10, 1.00 = 100, etc.)

Example:

- Indicate feet to the hundredths (0.00) with 100 pulses per foot:
Scale Factor would be $100 / (100 \times 1 \times 1) = 1$
(In this case, the scale multiplier and counter mode factor are 1)
- Indicate feet with 120 pulses per foot: Scale Factor would be $1 / (120 \times 1 \times 1) = 0.0083333$. (In this case, the scale multiplier of 0.01 could be used: $1 / (120 \times 1 \times 0.01) = 0.83333$ or show to hundredths (0.00): $100 / (120 \times 1 \times 1) = 0.8333$.)

General Rules on Scaling

- It is recommended that, the scale factor be as close as possible to, but not exceeding 1.00000. This can be accomplished by increasing or decreasing the counter decimal point position, using the scale multiplier, or selecting a different count mode.
- To double the number of pulses per unit, use counter modes direction X2 or quad X2. To increase it by four times, use counter mode quad X4. Using these modes will decrease the allowable maximum input frequency.
- A scale factor greater than 1.00000 will cause Counter display rounding. In this case, digit jumps could be caused by the internal count register rounding the display. The precision of a counter application cannot be improved by using a scale factor greater than 1.00000.
- The number of pulses per single unit must be greater than or equal to the DDD value in order for the scale factor to be less than or equal to one.
- Lowering the scale factor can be accomplished by lowering the counter decimal position. (Example: 100 (Hundredths)/10 pulses = 10.000 lowering to 10 (Tenths)/10 = 1.000.)

6.1.2 RATE INPUT PARAMETERS (RATE)

This section details programming for the Rate indicators (A, B and C) and the Maximum and Minimum Rate Capture displays. For maximum input frequency, the Rate indicators should be disabled when they are not in use. When Rate Enable (Rate A and B) or Rate Calculation (Rate C) is set to **NO** or **NOPE**, the remaining related parameters are not accessible. In the display depictions shown in this section, "x" represents A or B for the rate indicator being programmed.

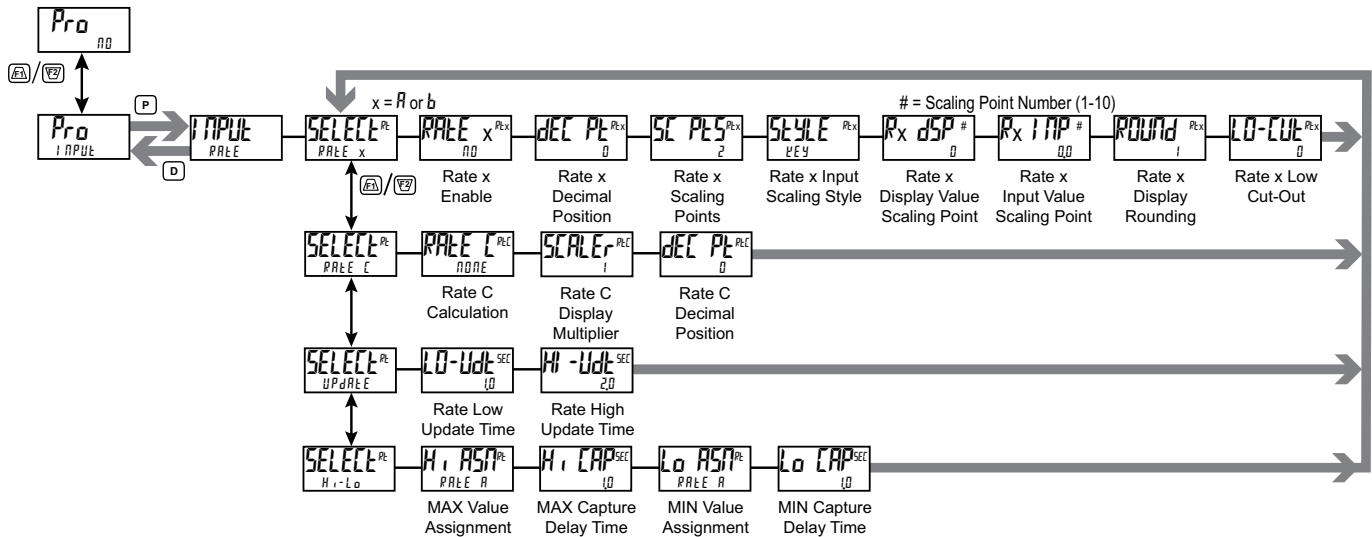

RATE SELECTION



RATE A RATE C H, -Lo
 RATE b UPdATE

Select the Rate parameters to be programmed.

RATE ENABLE

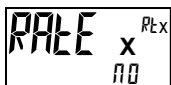

NO YES

Select YES to measure the rate (speed) of pulses on the corresponding Input. Rate measurement is independent of the corresponding Counter count modes.

RATE DECIMAL POSITION



0 0.00 0.0000
 0.0 0.000

This selects the decimal point position for the selected Rate indicator.

RATE SCALING POINTS

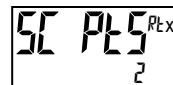

2 to 10

This parameter sets the number of scaling points for the Rate Scaling function. The number of scaling points used depends on the linearity of the process and the display accuracy required.

About Scaling Points

Each scaling point is specified by two programmable parameters: A desired Rate Display Value (Rx dSP) and a corresponding Rate Input Value (Rx INP). Scaling points are entered sequentially in ascending order of Rate Input value. Each scaling point defines the upper endpoint of a linear segment, with the lower endpoint being the previous scaling point.

Linear Application – 2 Scaling Points

Linear processes use two scaling points to provide a linear Rate display from 0 up to the maximum input frequency. For typical zero based frequency measurements, the lower point is set to display 0 for 0 Hz input (factory setting) and the upper point set to display the desired value for a given input frequency. For non-zero based applications, the lower point is set to the desired display for 0 Hz input.

Non-linear Application – Up to 10 Scaling Points

For non-linear processes, up to 10 scaling points may be used to provide a piece-wise linear approximation representing the non-linear function. The Rate Display will be linear between sequential scaling points. Thus, the greater the number of scaling points, the greater the conformity accuracy. The Crimson software provides several linearization equations for common Rate applications.

RATE INPUT SCALING STYLE



KEY APPLY

Rate Input values for scaling points can be entered by using the Key-in or the Applied style described below.

Key-in:

Enter the Rate Input value by pressing the $\sqrt{F1}$ or $\sqrt{F2}$ keys. This value is always in pulses per second (Hz).

Applied:

The existing programmed Rate Input value will appear. To retain this value, press the **P** key to continue to the next parameter. To enter a new value, apply an external rate signal to the appropriate input terminal. Press the $\sqrt{F2}$ key and the applied input frequency (in Hz) will be displayed. To insure the correct reading, wait until a consistent reading is displayed, then press the **P** key to accept this value as the Rate Input Value and continue to the next parameter. Follow the same procedure if using more than 2 scaling points.

RATE DISPLAY VALUE SCALING POINT 1



0 to 999999

For all zero-based applications (display value 0 for 0 Hz input), the Display Value and Input Value for Scaling Point 1 should be set to 0 and 0.0 respectively. For non-zero based applications, enter the desired Display Value for a 0 Hz input.

RATE INPUT VALUE SCALING POINT 1



0.0 to 99999.9

Normally the Rate Input Value for Scaling Point 1 is 0.0.

RATE DISPLAY VALUE SCALING POINT 2



0 to 999999

Enter the desired Rate Display Value for Scaling Point 2.

RATE INPUT VALUE SCALING POINT 2



0.0 to 99999.9

Enter the corresponding Rate Input Value for Scaling Point 2, by using the Input Scaling Style selected.

RATE DISPLAY ROUNDING



1 5 20 100
2 10 50

Rounding values other than '1' round the Rate display to the nearest increment selected (e.g. rounding of '5' causes 122 to round to 120 and 123 to round to 125). Rounding starts at the least significant digit of the Rate display.

RATE LOW CUT-OUT



0 to 999999

The Low Cut Out value forces the Rate display to zero when the Rate display falls below the value entered.

RATE SCALING

To scale the Rate, enter a Scaling Display value with a corresponding Scaling Input value. (The Display and Input values can be entered by Key-in or Applied Methods.) These values are internally plotted to a Display value of 0 and Input value of 0 Hz. A linear relationship is formed between these points to yield a rate display value that corresponds to the incoming input signal rate.

KEY-IN SCALING METHOD CALCULATION

If a display value versus input signal (in pulses per second) is known, then those values can be entered into Scaling Display ($R_x dSP$) and Scaling Input ($R_x I/P$). No further calculations are needed.

If only the number of pulses per 'single' unit (i.e. # of pulses per foot) is known, then it can be entered as the Scaling Input value and the Scaling Display value will be entered as the following:

RATE PER	DISPLAY ($R_x dSP$)	INPUT ($R_x I/P$)
Second	1	# of pulses per unit
Minute	60	# of pulses per unit
Hour	3600	# of pulses per unit

NOTES:

- If # of pulse per unit is less than 10, then multiply both Input and Display values by 10.
- If # of pulse per unit is less than 1, then multiply both Input and Display values by 100.
- If the Display value is raised or lowered, then Input value must be raised or lowered by the same proportion (i.e. Display value for per hour is entered by a third less (1200) then Input value is a third less of # of pulses per unit). The same is true if the Input value is raised or lowered, then Display value must be raised or lowered by the same proportion.

EXAMPLE:

- With 15.1 pulses per foot, indicate feet per minute in tenths. Scaling Display = 60.0 Scaling Input = 15.1.
- With 0.25 pulses per gallon, indicate whole gallons per hour. (To have greater accuracy, multiply both Input and Display values by 10.) Scaling Display = 36000 Scaling Input = 2.5.

RATE C PARAMETERS



RATE C CALCULATION



Select the calculation for the Rate C display.

SELECTION	MODE	DESCRIPTION
NONE	None	Rate C disabled.
Add A/B	SUM (A+B)	Rate C shows the sum of Rate A and Rate B.
Sub A/B	DIFFERENCE (A-B)	Rate C shows the difference of Rate A and Rate B.
Pct A/B	RATIO (A/B)	Rate C shows the percentage of Rate A to Rate B.
Pct A	PERCENT OF TOTAL (A/A+B)	Rate C shows the percentage of Rate A to the total of Rate A and Rate B.
Pct dr	PERCENT DRAW (A-B/B)	Rate C shows the percent draw between Rate A and Rate B.

RATE C DISPLAY MULTIPLIER



Set the Display Multiplier to obtain the desired Rate C display resolution. For Rate C percentage calculations, the result is internally multiplied by 100 to show percent as a whole number. By using a Display Multiplier of 10, 100 or 1000, along with the proper decimal point position, percentage can be shown in tenths, hundredths or thousandths respectively.

RATE C DECIMAL POSITION



Select the decimal point position for Rate C.

RATE UPDATE PARAMETERS



RATE LOW UPDATE TIME (DISPLAY UPDATE)

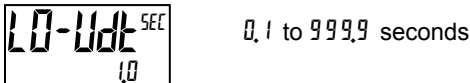

The Low Update Time is the minimum amount of time between display updates for all enabled Rate displays. Small Low Update Time values may increase the possibility of the display indicating an unstable input (jittery display). The factory setting of 1.0 will update the display at a minimum of every second.

RATE HIGH UPDATE TIME

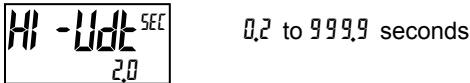

The High Update Time is the maximum amount of time before the enabled Rate displays are forced to zero. (For more explanation, refer to Input Frequency Calculation.) The High Update Time must be higher than the Low Update Time and higher than the desired slowest readable speed (one divided by pulses per second). The factory setting of 2.0, will force the display to zero for speeds below 0.5 Hz or a pulse every 2 seconds.

INPUT FREQUENCY CALCULATION

The unit determines the input frequency by summing the number of falling edges received during a sample period of time. The sample period begins on the first falling edge. At this falling edge, the unit starts accumulating time towards Low Update and High Update values. Also, the unit starts accumulating the number of falling edges. When the time reaches the Low Update Time value, the unit looks for one more falling edge to end the sample period. If a falling edge occurs (before the High Update Time value is reached), the Rate display will update to the new value and the next sample period will start on the same edge. If the High Update Time value is reached (without receiving a falling edge after reaching Low Update Time), then the sample period will end but the Rate display will be forced to zero. The High Update Time value must be greater than the Low Update Time value. Both values must be greater than 0.0. The input frequency calculated during the sample period, is then shown as a Rate value

RATE VALUE CALCULATED

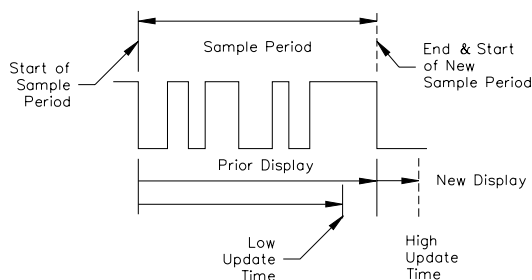

ZERO RATE CALCULATED

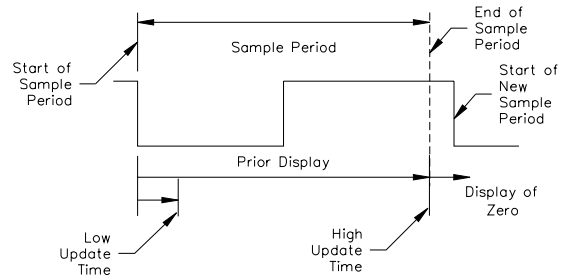

determined by either scaling method.

RATE MAXIMUM/MINIMUM CAPTURE PARAMETERS



MAXIMUM CAPTURE VALUE ASSIGNMENT



Select the Rate display to which the Maximum Capture value is assigned.

MAXIMUM CAPTURE DELAY TIME



When the assigned Rate value is above the present Maximum rate value for the entered amount of time, the unit will capture that Rate value as the new Maximum value. A delay time helps to avoid false captures of sudden short spikes.

MINIMUM CAPTURE VALUE ASSIGNMENT



Select the Rate display to which the Minimum Capture value is assigned.

MINIMUM CAPTURE DELAY TIME



When the assigned Rate value is below the present Minimum rate value for the entered amount of time, the unit will capture that Rate value as the new Minimum value. A delay time helps to avoid false captures of sudden short spikes.

6.1.3 USER INPUT/FUNCTION KEY PARAMETERS (USER)

This section details the programming for the rear terminal User Inputs and front panel Function Keys. Three user inputs are individually programmable to perform specific unit control functions. While in the Display Mode, the function is executed when the user input transitions to the active state. (Refer to the user input specifications for response times.) Certain User input functions are disabled in Programming Mode. Two front panel function keys, $\overline{F1}$ and $\overline{F2}$, are also individually programmable to perform specific unit control functions. While in the Display Mode, the primary function is executed when the key is pressed. Holding the $\overline{F1}$ or $\overline{F2}$ function key for three seconds executes a secondary function. It is possible to program a secondary function without a primary function. The front panel key functions are disabled while in Programming Mode.

In most cases, if more than one user input and/or function key is programmed for the same function, the maintained (level trigger) actions will be performed while at least one of those user inputs or function keys are activated. The momentary (edge trigger) actions are performed every time any of those user inputs or function keys transition to the active state.

The List user function has a value assignment sublist, which appears when the **P** key is pressed and **LI 5t** is selected. The function will only be performed for the assignment values selected as **YES**. If a user input or function key is configured for a function with a sublist, then that sublist will need to be scrolled through each time to access the remaining user inputs or function keys following the sublist.

Note: In the following explanations, not all selections are available for both user inputs and front panel function keys. Displays are shown with each selection. Those selections showing both displays are available for both. If a display is not shown, it is not available for that selection. In the parameter explanations, *USER-n* represents all user inputs. *Fn* represents both function keys and second function keys.

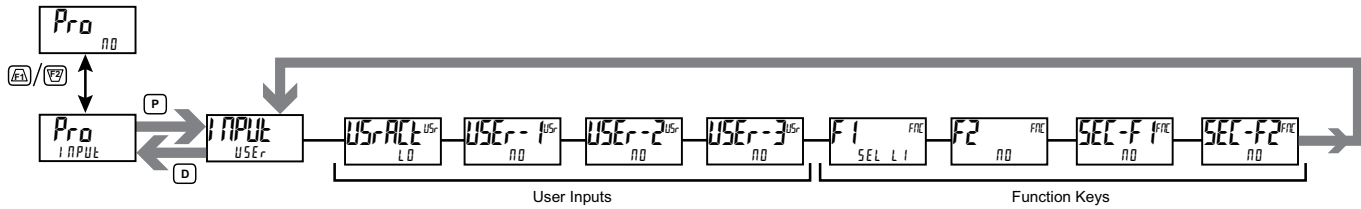

USER INPUT ACTIVE STATE



L0 HI

Select the desired active state for the User Inputs. Select **L0** for sink input, active low. Select **HI** for source input, active high.

NO FUNCTION

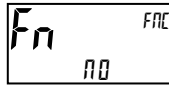

No function is performed if activated. This is the factory setting for all user inputs and second function keys.

PROGRAMMING MODE LOCK-OUT



Programming Mode is locked-out, as long as activated (maintained action). A security code can be configured to allow programming access during lock-out.

SELECT LINE 1 DISPLAY



When activated (momentary action), the display advances to the next Line 1 display that has been made available (in the Display Module, Line 1/Select sub-menu). This is the factory setting for function key $\overline{F1}$.

SELECT LINE 2 DISPLAY



When activated (momentary action), the display advances to the next Line 2 display that has been made available (in the Display Module, Line 2/Access sub-menu).

RESET LINE 1 DISPLAY

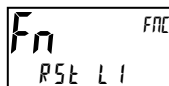

When activated (momentary action), resets the current Line 1 Display value. This is the factory setting for function key $\overline{F2}$.

RESET LINE 2 DISPLAY



When activated (momentary action), resets the current Line 2 Display value.

RESET LINE 1 AND LINE 2 DISPLAYS



When activated (momentary action), resets both the current Line 1 Display value and Line 2 Display value.

CHANGE DISPLAY COLOR



When activated (momentary action), Line 1 will change color green to red, red to orange, orange to green.

ADJUST DISPLAY INTENSITY LEVEL



When activated (momentary action), the display intensity changes to the next intensity level.

ADJUST DISPLAY CONTRAST LEVEL



When activated (momentary action), the display contrast changes to the next higher level.

TURN OFF METER DISPLAY



Turns off the display backlight when activated. If a user input is used, the backlight is off when the user input is active (maintained action). If a front panel key is used, the backlight will toggle for each key press (momentary action). The backlight is always on in programming mode.

SELECT PARAMETER LIST

Two lists of values are available to allow the user to switch between two sets of Setpoints, Scale Factors, Counter Load values and Units mnemonics. The two lists are List A and List B. If a user input is used to select the list then List A is selected when the user input is not active and List B is selected when the user input is active (maintained action). If a front panel key is used to select the list then the list will toggle for each key press (momentary action). The display will only indicate which list is active when the list is changed.

A submenu is used to select whether the programmed Units Mnemonics are included in the List function. Select *YES* in the submenu to have different Units Mnemonics for List A and List B. Select *NO* to display the same mnemonics regardless of the list selected.

To program the values for List A and List B, first complete the programming of all the parameters with List A selected. Exit programming and switch to List B. Re-enter programming and program the desired values for the parameters included in the List.

DISPLAY	DESCRIPTION	FACTORY
UNIT S	Units Mnemonics	NO

PRINT REQUEST

The unit issues a block print through the serial port when activated, and the serial type is set to *RL*. The data transmitted during a print request and the serial type is programmed in Port (Serial) module. If the user input is still active after the transmission is complete (about 100 msec), an additional transmission occurs. As long as the user input is held active, continuous transmissions occur.

PRINT REQUEST AND RESET DISPLAYS

The unit issues a block print through the serial port when activated just like the Print Request function. In addition, when activated (momentary action), the unit performs a reset of the displays configured as *YES* in the sublist. Both the Print and Reset actions will only function when the serial type parameter (*TYPE*) is set to Red Lion protocol (*RL*).

DISPLAY	DESCRIPTION	FACTORY
[n t A	Counter A	NO
[n t b	Counter B	NO
[n t C	Counter C	NO
H i	Maximum	NO
L o	Minimum	NO

MAINTAINED (LEVEL) RESET AND INHIBIT

The unit performs a reset and inhibits the displays configured as *YES* in the sublist, as long as activated (maintained action).

DISPLAY	DESCRIPTION	FACTORY
[n t A	Counter A	NO
[n t b	Counter B	NO
[n t C	Counter C	NO
H i	Maximum	NO
L o	Minimum	NO

MOMENTARY (EDGE) RESET

When activated (momentary action), the unit resets the displays configured as *YES* in the sublist.

DISPLAY	DESCRIPTION	FACTORY
[n t A	Counter A	NO
[n t b	Counter B	NO
[n t C	Counter C	NO
H i	Maximum	NO
L o	Minimum	NO

INHIBIT

The unit inhibits the displays configured as *YES* in the sublist, as long as activated (maintained action).

DISPLAY	DESCRIPTION	FACTORY
[n t A	Counter A	NO
[n t b	Counter B	NO
[n t C	Counter C	NO
H i	Maximum	NO
L o	Minimum	NO

STORE DISPLAY

The unit holds (freezes) the displays configured as *YES* in the sublist, as long as activated (maintained action). Internally, the counters and max and min values continue to update.

DISPLAY	DESCRIPTION	FACTORY
[n t A	Counter A	NO
[n t b	Counter B	NO
[n t C	Counter C	NO
H i	Maximum	NO
L o	Minimum	NO

STORE AND RESET DISPLAY

The unit holds (freezes) the displays and then performs a reset of the displays configured as *YES* in the sublist, as long as activated (maintained action).

DISPLAY	DESCRIPTION	FACTORY
[n t A	Counter A	NO
[n t b	Counter B	NO
[n t C	Counter C	NO
H i	Maximum	NO
L o	Minimum	NO

SETPOINT DEACTIVATE (RESET) MAINTAINED (LEVEL)

The unit deactivates (resets) the setpoint outputs configured as *YES* in the sublist, as long as activated (maintained action).

DISPLAY	DESCRIPTION	FACTORY
S 1	Setpoint 1	NO
S 2	Setpoint 2	NO
S 3	Setpoint 3	NO
S 4	Setpoint 4	NO

SETPOINT DEACTIVATE (RESET) MOMENTARY (EDGE)

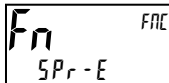
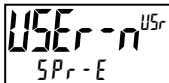

When activated (momentary action), the unit deactivates (resets) the setpoint outputs configured as YES in the sublist.

DISPLAY	DESCRIPTION	FACTORY
51	Setpoint 1	NO
52	Setpoint 2	NO
53	Setpoint 3	NO
54	Setpoint 4	NO

SETPOINT ACTIVATE (SET) MOMENTARY (EDGE)



When activated (momentary action), the unit activates (sets) the setpoint outputs configured as YES in the sublist.

DISPLAY	DESCRIPTION	FACTORY
51	Setpoint 1	NO
52	Setpoint 2	NO
53	Setpoint 3	NO
54	Setpoint 4	NO

SETPOINT ACTIVATE (SET) MAINTAINED (LEVEL)

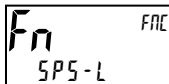

The unit activates (sets) the setpoint outputs configured as YES in the sublist, as long as activated (maintained action).

DISPLAY	DESCRIPTION	FACTORY
51	Setpoint 1	NO
52	Setpoint 2	NO
53	Setpoint 3	NO
54	Setpoint 4	NO

HOLD SETPOINT STATE



The unit holds the state of the setpoint outputs configured as YES in the sublist, as long as activated (maintained action).

DISPLAY	DESCRIPTION	FACTORY
51	Setpoint 1	NO
52	Setpoint 2	NO
53	Setpoint 3	NO
54	Setpoint 4	NO

6.2 OUTPUT PARAMETERS (OUTPUT)

OUTPUT SELECT



SETPnt ANALOG

Select the Setpoint or Analog output to be programmed. The Analog output selection only appears if an analog output option card is installed in the unit.

6.2.1 SETPOINT OUTPUT PARAMETERS (SETPnt)

This section details the programming for the setpoints. To have output capabilities, a setpoint option card needs to be installed into the PAX2D (see Ordering Information). Depending on the card installed, there will be two or four setpoint outputs available. If no output card is installed, programming for the setpoints is still available. An Exchange Parameter Lists feature for setpoint values is explained in User Input programming. For maximum input frequency, unused setpoints should be configured for NO action.

The Setpoint Assignment and Setpoint Output Action determine setpoint feature availability. The Setpoint Parameter Availability chart illustrates this.

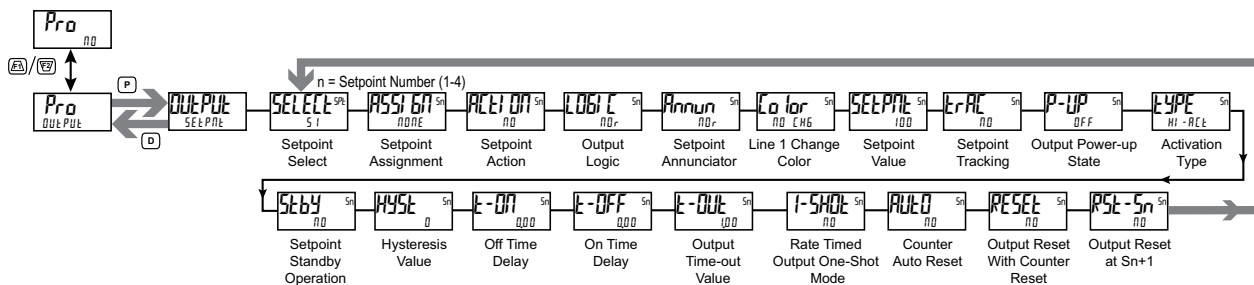

SETPOINT PARAMETER AVAILABILITY

PARAMETER	DESCRIPTION	COUNTER ASSIGNMENT			RATE ASSIGNMENT		
		TIMED OUT t-OUT	BOUNDARY BOUND	LATCH LATCH	TIMED OUT t-OUT	BOUNDARY BOUND	LATCH LATCH
LOGIC	Setpoint Output Logic	Yes	Yes	Yes	Yes	Yes	Yes
Annun	Setpoint Annunciator	Yes	Yes	Yes	Yes	Yes	Yes
Color	Setpoint Line 1 Color	Yes	Yes	Yes	Yes	Yes	Yes
SEtPnt	Setpoint Value	Yes	Yes	Yes	Yes	Yes	Yes
TrAC	Setpoint Tracking	Yes	Yes	Yes	Yes	Yes	Yes
P-UP	Setpoint Output Power-up State	No	No	Yes	No	No	Yes
TYPE	Setpoint Activation Type	No	Yes	No	Yes	Yes	Yes
StBY	Standby Operation	No	Yes	No	Yes	Yes	Yes
HYS	Setpoint Hysteresis	No	No	No	Yes	Yes	No
E-ON	Setpoint On Time Delay	No	No	No	Yes	Yes	Yes
E-OFF	Setpoint Off Time Delay	No	No	No	No	Yes	No
E-OUT	Setpoint Output Time-out Value	Yes	No	No	Yes	No	No
I-SHOT	Rate Timed Output One-shot	No	No	No	Yes	No	No
RUC	Counter Auto Reset	Yes	No	Yes	No	No	No
RESEt	Output Reset with Manual Reset	Yes	No	Yes	No	No	No
RSE-Sn	Setpoint Output Reset at Sn+1	Yes	No	Yes	No	No	No

SETPOINT SELECT



51 52 53 54

Select the Setpoint output to be programmed. The “5n” in the following parameters will reflect the chosen setpoint number. After the chosen setpoint is completely programmed, the display returns to the Setpoint Select menu. Repeat steps for each setpoint to be programmed.

The number of outputs available is setpoint output card dependent (2 or 4). If no output card is installed, programming is still available for all setpoints. This allows the Line 1 color change feature to provide a visual indication when a setpoint value has been reached, even if no setpoint output card is being used.

SETPOINT ASSIGNMENT



NONE ENT X RATE X

Select the display to which the setpoint is assigned.

SELECTION	DISPLAY VALUE
NONE	Manual Mode operation (See SERIAL RLC PROTOCOL)
ENT X	Counter Display Value (x = A, B or C)
RATE X	Rate Display Value (x = A, B or C)

SETPOINT ACTION



NO LATCH T-OUT BOUND

Select the desired Setpoint Output Action. Choose NO (no action) if a setpoint is unused or for manual mode operation. See “Setpoint (Alarm) Figures for Rate” for a visual detail of Rate Assigned setpoint actions.

For Counter Assignments:

LATCH	LATCH Action - The setpoint output activates when the count value equals the setpoint value. The output remains active until reset.
T-OUT	TIMED OUT Action - The setpoint output activates when the count value equals the setpoint value and deactivates after the Time Out value.
BOUND	BOUNDARY Action - The setpoint output activates when the count value is greater than or equal to (for TYPE = HI - RCT) or less than or equal to (for TYPE = LO - RCT) the setpoint value. The setpoint output will deactivate when the count value is less than (for TYPE = HI - RCT) or greater than (for TYPE = LO - RCT) the setpoint value.

For Rate Assignments:

LATCH	LATCH Action - The setpoint output activates when the rate value is equal to the setpoint value. The setpoint output remains active until reset. If after reset, the rate value is greater than or equal to (for TYPE = HI - RCT) or less than or equal to (for TYPE = LO - RCT) the setpoint value, the output will reactivate.
T-OUT	TIMED OUT Action - The setpoint output cycles when the rate value is greater than or equal to (for TYPE = HI - RCT) or less than or equal to (for TYPE = LO - RCT) the setpoint value. The Setpoint Time Out (T-OUT) and Setpoint On Delay (T-ON) values determine the cycling times. One-shot mode provides a single output pulse (T-OUT) rather than on/off cycling.
BOUND	BOUNDARY Action - The setpoint output activates when the rate value is greater than or equal to (for TYPE = HI - RCT) or less than or equal to (for TYPE = LO - RCT) the setpoint value. The setpoint output will deactivate (Auto reset) as determined by the Hysteresis value.

OUTPUT LOGIC



NOr rEU

Enter the output logic of the alarm output. The NOr logic leaves the output operation as normal. The rEU logic reverses the output logic. In rEU, the alarm states in the Setpoint Alarm Figures are reversed.

SETPOINT ANNUNCIATOR



NOr rEU FLASH OFF

The NOr mode displays the corresponding setpoint annunciators of “on” alarm outputs. The rEU mode displays the corresponding setpoint annunciators of “off” alarms outputs. The FLASH mode flashes the corresponding setpoint annunciators of “on” alarm outputs. The OFF mode disables display setpoint annunciators.

LINE 1 CHANGE COLOR



NO CHG GREEN ORANGE rEd
GrnOrG rEdOrG rEdGrn LINE 1

This parameter allows the Line 1 Display to change color, or alternate between two colors, when the alarm is activated. When multiple alarms are programmed to change color, the highest numbered active alarm (S4-S1) determines the display color.

The NO CHG selection will maintain the color displayed prior to the alarm activation. The LINE 1 selection sets the display to the Display (Line 1) Color (Color).

SETPOINT VALUE



- 199999 to 999999

Enter desired setpoint alarm value. Setpoint values can also be entered in the Display Mode during Program Lockout when the setpoint is programmed as ENTER in the Display (Line 2) Access parameters. The decimal point position is determined by the Setpoint Assignment value.

SETPOINT TRACKING



NO 52 54 CLD b
51 53 CLD A CLD C

If a selection other than NO is chosen, then the value of the setpoint being programmed (“n”) will track the entered selection’s value. Tracking means that when the selection’s value is changed, the “n” setpoint value will also change (or follow) by the same amount.

OUTPUT POWER-UP STATE



OFF ON SAVE

OFF will deactivate the output at power up. ON will activate the output at power up. SAVE will restore the output to the same state it was at before the unit was powered down.

ACTIVATION (BOUNDARY) TYPE



HI - RCT LO - RCT

HI - RCT activates the output when the assigned display value (ASSIGN) equals or exceeds the setpoint value. LO - RCT activates the output when the assigned display value is less than or equal to the setpoint.

SETPOINT STANDBY OPERATION



NO YES

This parameter only applies to low acting setpoint activation (boundary) type setpoints. Select YES to disable a low acting setpoint at power-up, until the assigned display value crosses into the output “off” area. Once in the output “off” area, the setpoint will function per the description for low acting activation (boundary) type.

HYSTERESIS VALUE

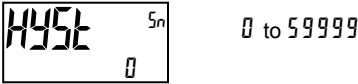

The hysteresis value is added to (for $TYPE = LO-Act$), or subtracted from (for $TYPE = HI-Act$), the setpoint value to determine at what value to deactivate the associated setpoint output. Hysteresis is only available for Rate assigned setpoints.

ON TIME DELAY



This is the amount of time the assigned Rate display must meet the setpoint activation requirements (below setpoint for Low Acting and above setpoint for High Acting), before the setpoint output activates. If the Rate Setpoint Action is Timed-Out, this is the amount of time the output is OFF during the ON/OFF output cycling. This parameter is only available for Rate assigned setpoints.

OFF TIME DELAY

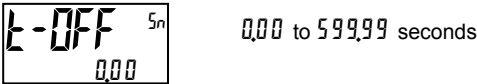

This is the amount of time the assigned Rate display must meet the setpoint deactivation requirements (below hysteresis for High Acting and above hysteresis for Low Acting), before the setpoint output deactivates. This parameter is only available for Rate assigned setpoints.

OUTPUT TIME-OUT



If the setpoint action is Timed Out and the setpoint is assigned to Counter, then this is the amount of time the output will activate once the count value equals the setpoint value. If the setpoint action is Timed Out and the setpoint is assigned to Rate, then this is the amount of time the output is ON during the ON / OFF output cycling. If Rate Timed Output One-Shot mode is enabled, then this is the time duration for the one-shot output pulse.

RATE TIMED OUTPUT ONE-SHOT



If the setpoint action is Timed Out and the setpoint is assigned to Rate, select **YES** to have the output activate for a single pulse (one-shot) when the assigned Rate display meets the setpoint activation requirements. Select **NO** for ON / OFF output cycling per the "Setpoint (Alarm) Figures For Rate" diagram.

COUNTER AUTO RESET



This automatically resets the display value of the Setpoint Assigned Counter each time the setpoint value is reached. The automatic reset can occur at output start or output end if the setpoint output action is programmed for timed output mode. The counter may be reset to zero or the count load value. This reset may be different from the counter reset action programmed in the Input Parameter (*INPUT*) menu section.

SELECTION	ACTION
NO	No Auto Reset
ZEr-Sk	Reset to Zero at the Start of output activation
CLd-Sk	Reset to Count Load value at the Start of output activation
ZEr-En	Reset to Zero at the End of output activation (timed out only)
CLd-En	Reset to Count Load at the End of output activation (timed out only)

OUTPUT RESET WITH COUNTER RESET



Selecting **YES** causes the Setpoint output to deactivate (reset) when the Setpoint Assigned Counter is reset. The only exception is when the assigned counter is reset by a setpoint generated counter auto reset.

OUTPUT RESET AT Sn+1



Selecting **Sn-Str** causes the setpoint output to deactivate (reset) when setpoint $S_n + 1$ activates. (Example: S1 deactivates when S2 activates, and S4 when S1 activates.) The last setpoint will wrap around to the first.

Selecting **Sn-End** causes the setpoint output to deactivate (reset) when setpoint $S_n + 1$ activates and then times out (deactivates). This selection only applies if the $S_n + 1$ setpoint action is Timed Out. (Example: S1 deactivates when S2 is activated and then times out.) The last setpoint will wrap around to the first. This parameter is only available for Counter assigned setpoints.

Setpoint (Alarm) Figures for Rate

(For Reverse Logic, The Alarm state is opposite.)

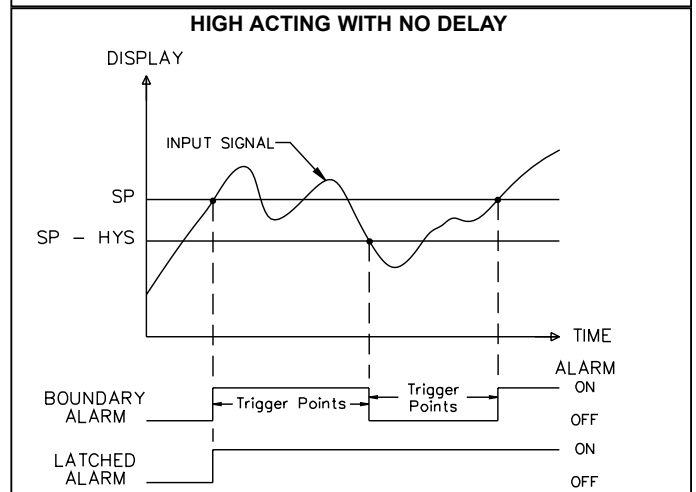
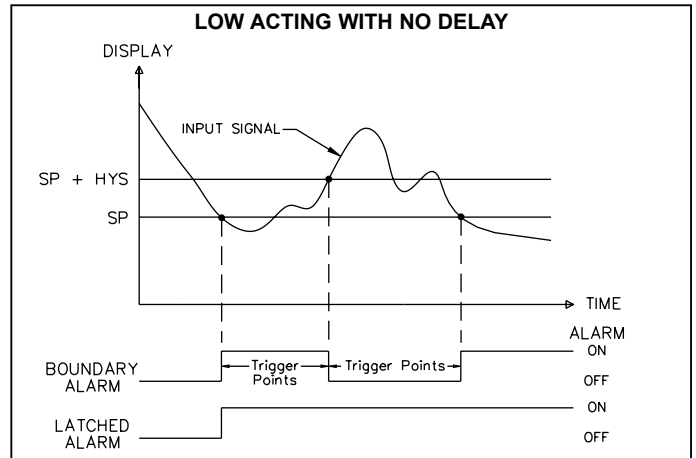

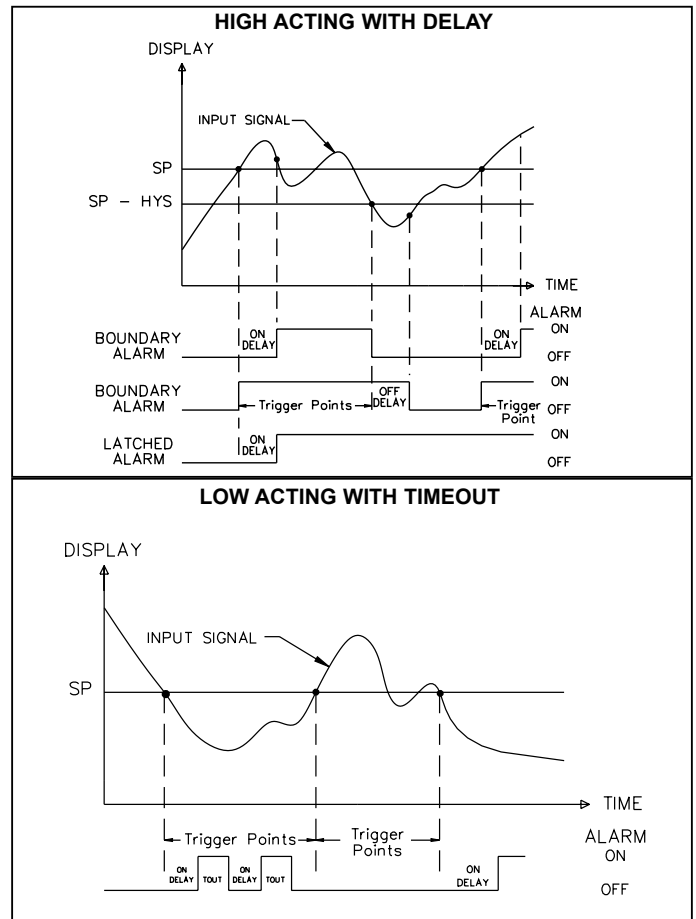
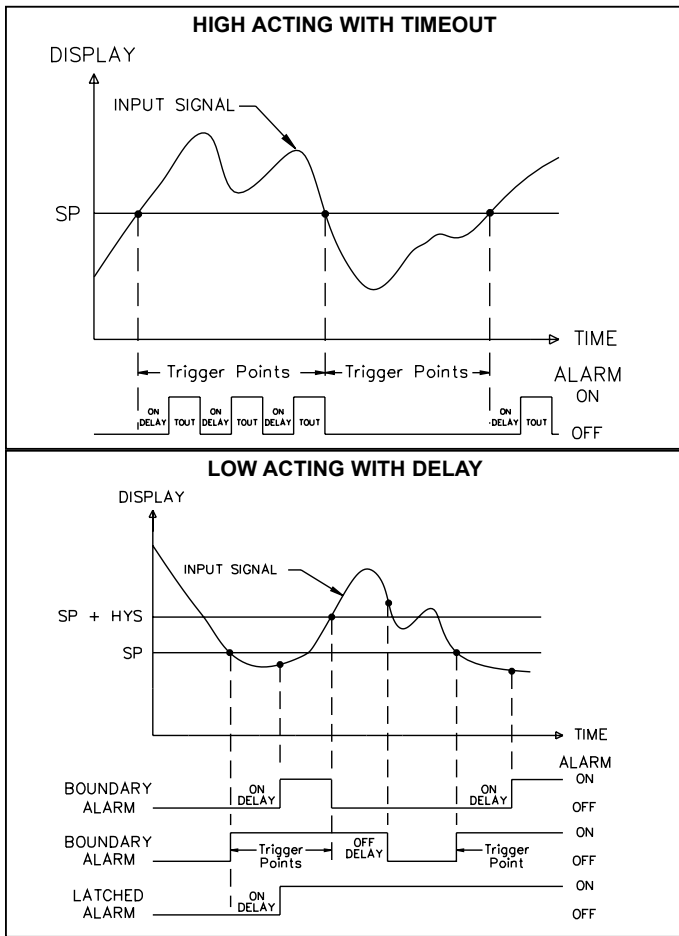

6.2.2 ANALOG OUTPUT PARAMETERS (ANALOG)

This section is only accessible with the optional PAXCDL Analog card installed (see Ordering Information).

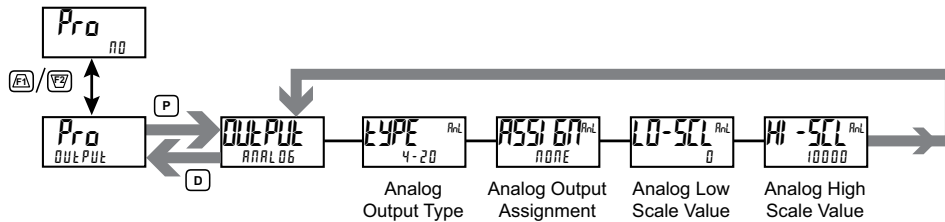

ANALOG OUTPUT TYPE

TYPE ANALOG
4-20

4-20 0-10 0-20

Enter the analog output type. For 0-20 mA or 4-20 mA use terminals 18 and 19. For 0-10 V use terminals 16 and 17. Only one range can be used at a time.

ANALOG LOW SCALE VALUE

LO-SCALE ANALOG
0

- 199999 to 999999

Enter the Display Value that corresponds to 0 mA (0-20 mA) , 4 mA (4-20 mA) or 0 VDC (0-10 VDC).

ANALOG OUTPUT ASSIGNMENT

ASSIGN ANALOG
NONE

Enter the source for the analog output to retransmit:

- | SELECTION | DISPLAY VALUE |
|-----------|--|
| NONE | Manual Mode operation . (See Serial RLC Protocol in the Communications Port module). |
| Entxx | Counter Display Value (x = A, B or C) |
| RREx | Rate Display Value (x = A, B or C) |
| Hi | Maximum Display Value |
| Lo | Minimum Display Value |
| S1-S4 | Setpoint Value (S1-S4) |

ANALOG HIGH SCALE VALUE

HI-SCALE ANALOG
10000

- 199999 to 999999

Enter the Display Value that corresponds to 20 mA (0-20 mA) , 20 mA (4-20 mA) or 10 VDC (0-10 VDC).

6.3 DISPLAY PARAMETERS (d SPLY)

DISPLAY LINE SELECT



LINE 1 LINE 2

Select the Display Line to be programmed.

6.3.1 LINE 1 PARAMETERS (LINE 1)

This section details programming for the Line 1 (Top Line) Display. The Input, Gross, Tare, Total, Maximum (HI) and Minimum (LO) capture values and setpoints can be shown on the Line 1 display. The 3-digit Units mnemonic characters can be used to indicate which Line 1 display value is shown. Standard or custom mnemonics are available for Line 1 values.

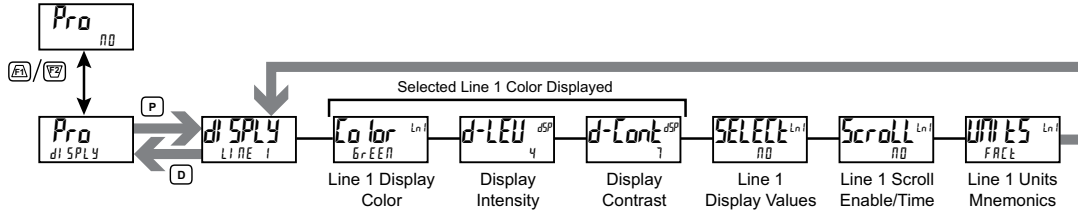

LINE 1 DISPLAY COLOR



GREEN red ORANGE

Enter the desired Display Line 1 and programmable Units Display color.

LINE 1 DISPLAY SCROLL ENABLE/TIME



NO 1 to 15 seconds

If Line 1 Display Scrolling is desired, set the scroll time in seconds.

DISPLAY INTENSITY LEVEL



1 to 4

Enter the desired Display Intensity Level (1-4) by using the arrow keys. The display will actively dim or brighten as the levels are changed. This parameter can also be accessed in the Parameter display loop when enabled.

LINE 1 UNITS MNEMONIC(S)



OFF LABEL CUST FACT

Select the mode for Line 1 Units Mnemonic(s). See LINE 1 UNITS MNEMONIC DIAGRAM for programming details.

SELECTION	MODE	DESCRIPTION
OFF	OFF	No Line 1 mnemonic shown.
LABEL	LABEL	Single programmable mnemonic shown for all Line 1 values.
CUST	CUSTOM	Custom programmable mnemonics shown for each Line 1 value.
FACT	FACTORY	Factory default mnemonics shown for each Line 1 value.

The characters available for the programmable modes include:

A B C D E F G H I J K L M N O P Q R S T U V W X Y Z 0 1
2 3 4 5 6 7 8 9 a b c d e f g h i j k l m n o p q r s t u v w x y z . blank

Two character spaces are required to display this character.

LINE 1 DISPLAY VALUE SELECT/ENABLE



NO YES

Enter YES to select which values will be shown on the Line 1 display. A sub-menu provides Yes/No selection for each available Line 1 value. Values set to YES in the sub-menu will be displayable on Line 1.

DISPLAY	DESCRIPTION	FACTORY
Cnt A	Counter A	YES
Cnt B	Counter B	NO
Cnt C	Counter C	NO
Rate A	Rate A	NO
Rate B	Rate B	NO
Rate C	Rate C	NO
Hi	Max Value	NO
Lo	Min Value	NO

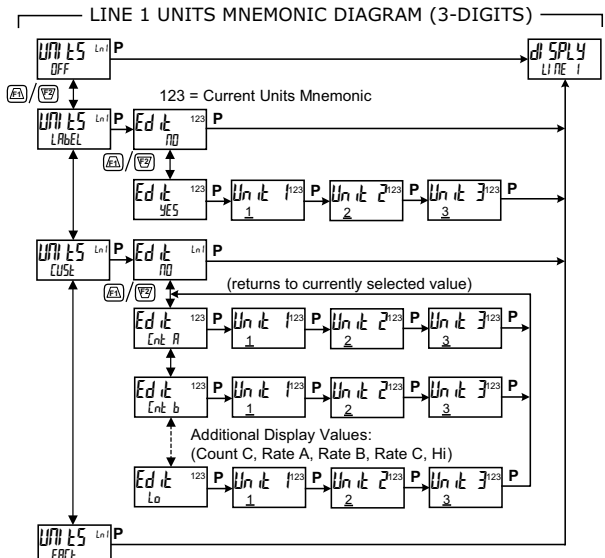

6.3.2 LINE 2 PARAMETERS (LINE 2)

This section details programming for the Line 2 (Bottom Line) Display. The Counter values, Rate values, Rate Capture values, Setpoint values and Parameter List A/B status can all be shown on the Line 2 display. The display loops described below are used to view, reset and modify the selected display values, based on the Line 2 Value Access setting programmed for each available value.

Main Display Loop

In the Main Display Loop, the selected values can be consecutively read on Line 2 by pressing the **D** key. A left justified 2 or 3-character mnemonic indicates which Line 2 value is currently shown. When in the Main display loop, the Function keys **F1** and **F2** perform the User functions programmed in the User Input program section.

Parameter Display Loop and Hidden Parameter Loop

These display loops provide quick access to selected parameters that can be viewed and modified on Line 2 without having to enter Full Programming Mode. These values include Parameter List A/B selection, Setpoints, Scale Factors, Counter Load values and Display Settings (color, intensity and contrast). To utilize the Parameter or Hidden Parameter loops, a security code (1-250) must be programmed. (See Programming Security Code at the end of this section.)

The Parameter display loop is accessed by pressing the **P** key. The selected Parameter display loop values can be viewed and/or changed per the Line 2 Value Access setting programmed for each available value. The Hidden Parameter Loop follows the Parameter display loop, and can only be accessed when the correct security code is entered at the Code prompt.

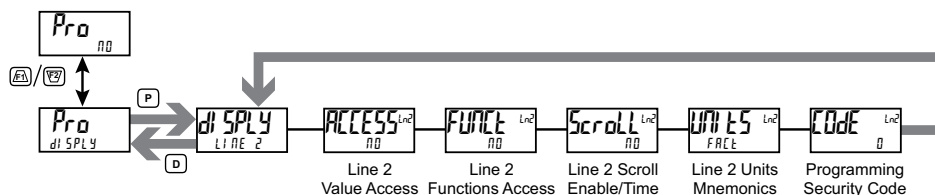

LINE 2 VALUE ACCESS



Select **YES** to program the Value Access setting for each available Line 2 parameter. Line 2 values can be made accessible in either the Main (**D** key), Parameter (**P** key) or Hidden (**P** key following code entry) display loops.

Each parameter must be configured for one of the following settings. Not all settings are available for each parameter, as shown in the Parameter Value Access table.

SELECTION	DESCRIPTION
LDC	Not viewed on Line 2 Display (Factory Default Setting)
d-rERd	View in Main display loop. Cannot change or reset.
d-rSt	View and reset in Main display loop.
d-EntR	View and change in Main display loop
P-rERd	View in Parameter display loop. Cannot change or reset.
P-EntR	View and change in Parameter display loop
HidE	View and change in Hidden Parameter display loop

LINE 2 FUNCTIONS ACCESS



Select **YES** to display the following list of functions that can be made available at the end of the Parameter (**P-EntR**) or Hidden (**HidE**) display loops. Each Line 2 Function can be programmed for **LDC**, **P-EntR**, or **HidE**.

The more critical and frequently used functions should be first assigned to the User Inputs and User Function keys, however if more functions are needed than what can be obtained with user inputs and function keys, these will provide a means to provide that access. Refer to Input module, User sub-menu section for a description of the function.

SELECTION	DESCRIPTION
r-L1	Reset Line 1 Display Value
r-ctA	Reset Counter A
r-ctB	Reset Counter B
r-ctC	Reset Counter C
r-RbC	Reset Counters A, B and C
r-Hi	Reset Maximum Rate Capture Value
r-Lo	Reset Minimum Rate Capture Value
r-HL	Reset Max and Min Rate Capture Values
Print	Print Request (Block Print)

LINE 2 PARAMETER VALUE ACCESS

DISPLAY	DESCRIPTION	NOT VIEWED	MAIN DISPLAY LOOP (D KEY)			PARAMETER DISPLAY LOOP (P KEY)		HIDDEN LOOP
			LDC	d-rERd	d-rSt	d-EntR	P-rERd	
Cnt A	Counter A	X	X	X				
Cnt b	Counter B	X	X	X				
Cnt C	Counter C	X	X	X				
RAte A	Rate A	X	X					
RAte b	Rate B	X	X					
RAte C	Rate C	X	X					
Hi	Max Value	X	X	X				
Lo	Min Value	X	X	X				
List	Parameter List A/B	X	X		X	X	X	X
Snx	Setpoint Value (S1-S4) *	X	X		X	X	X	X
Sc FAc	Scale Factor A, B, C *	X				X	X	X
Cnt Ld	Counter Load A, B, C *	X				X	X	X
Color	Line 1 Display Color	X				X	X	X
d-LEU	Display Intensity Level	X				X	X	X
d-Cont	Display Contrast Level	X				X	X	X

* Indicates multiple value entries.

LINE 2 DISPLAY SCROLL ENABLE/TIME



NO 1 to 15 seconds

If Line 2 Display Scrolling is desired, set the scroll time in seconds.

LINE 2 UNITS MNEMONIC(S)



OFF EUSL Lb-ESL Lb Ln1
LABEL FACT Lb-FAC L1-FAC

Select the mode for Line 2 Units Mnemonic(s). See LINE 2 UNITS MNEMONIC DIAGRAM for programming details.

SELECTION	MODE	DESCRIPTION
OFF	OFF	No Line 2 mnemonics shown.
LABEL	LABEL	Single programmable mnemonic shown as a separate item in the Line 2 Display loop. No individual mnemonics are shown with the other Line 2 Display values.
EUSL	CUSTOM	Individual Custom programmable mnemonics shown with each value in the Line 2 Display loop.
FACT	FACTORY	Individual Factory default mnemonics shown with each value in the Line 2 Display loop.
Lb-ESL	LABEL & CUSTOM	A programmable mnemonic shown as a separate item in the Line 2 Display loop. Also, individual Custom programmable mnemonics shown with each value in the Line 2 Display loop.
Lb-FAC	LABEL & FACTORY	A programmable mnemonic shown as a separate item in the Line 2 Display loop. Also, individual Factory default mnemonics shown with each value in the Line 2 Display loop.
Lb Ln1	LINE 1 INDEXED LABELS	Individual programmable mnemonics, indexed to the Line 1 Display value, are shown as a separate item in the Line 2 Display loop. These same mnemonics are also shown with each value in the Line 2 Display loop.
L1-FAC	LINE 1 INDEXED LABELS & FACTORY	Individual programmable mnemonics, indexed to the Line 1 Display value, are shown as a separate item in the Line 2 Display loop. Also, individual Factory default mnemonics are shown with each value in the Line 2 Display loop.

The characters available for the programmable modes include:

A b c d e f g h i j k l m n o p q r s t u v w x y z 0 1
2 3 4 5 6 7 8 9 a b c d e f g h i j k l m n o p q r s t u v w x y z 0 1 blank

Two character spaces are required to display this character.

PROGRAMMING SECURITY CODE



0 to 250

To activate either the Parameter or Hidden Parameter display loops, a security code (1-250) must be entered. If a "0" security code is programmed, pressing the P key takes you directly to the Full Programming Mode.

The Security Code determines the programming mode and the accessibility of programming parameters. This code can be used along with the Program Mode Lock-out (PLDL) in the User Input Function parameter (Input [User] module).

Two programming modes are available. Full Programming Mode allows all parameters to be viewed and modified. Parameter display loop mode provides access to those selected parameters, that can be viewed and/or modified without entering the Full programming mode.

The following chart indicates the levels of access based on various Code and User Input PLDL settings.

SECURITY CODE	USER INPUT CONFIGURED	USER INPUT STATE	WHEN P KEY IS PRESSED	FULL PROGRAMMING MODE ACCESS
0	not PLDL	_____	Full Programming	Immediate Access
0	PLDL	Not Active	Full Programming	Immediate Access
0	PLDL	Active	Enter Parameter Display Loop	No Access
>0	not PLDL	_____	Enter Parameter Display Loop	After Parameter Display Loop with correct code # at Code prompt.
>0	PLDL	Not Active	Full Programming	Immediate Access
>0	PLDL	Active	Enter Parameter Display Loop	After Parameter Display Loop with correct code # at Code prompt.

LINE 2 UNITS MNEMONIC DIAGRAM (9-DIGITS)

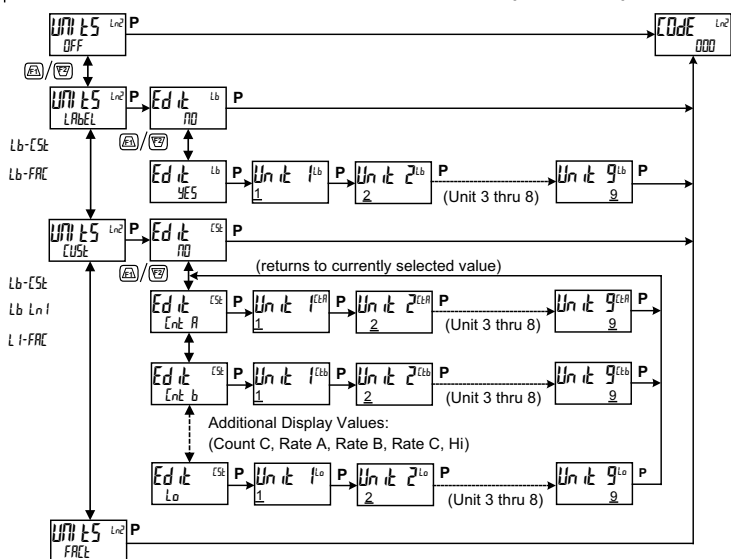

6.4 COMMUNICATIONS PORT PARAMETERS (Port)

To select *SErIAL*, an optional communication card must be installed.

PORT SELECT



USB SERIAL

Select the Communications Port to be programmed.

6.4.1 USB PORT PARAMETERS (USB)

USB CONFIGURATION



AUTO SERIAL

AUTO Unit automatically configures USB port settings to operate with Crimson configuration software. When a USB cable is attached to PAX2S and PC, the port is internally set to Modbus RTU protocol, 38400 baud, 8 bits, and Unit Address 247. The Serial Port settings programmed below will not change, or show this.

SErIAL Configures USB port to utilize the Serial Port settings and protocol programmed below.

6.4.2 SERIAL PORT PARAMETERS (SErIAL)

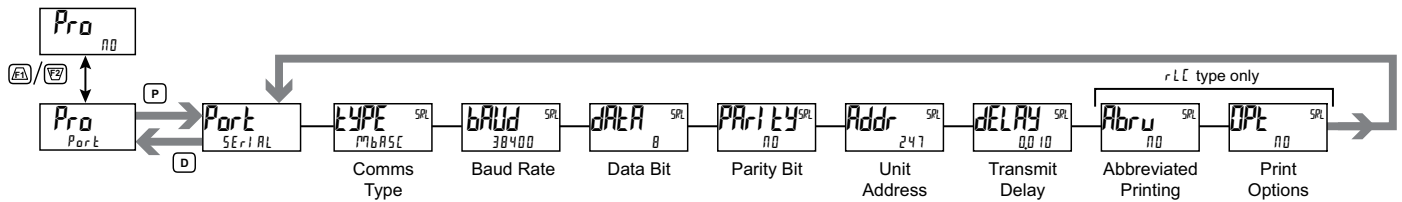

COMMUNICATIONS TYPE



Modbus - Modbus RTU
Modbus - Modbus ASCII
RLC - RLC Protocol (ASCII)

Select the desired communications protocol. Modbus is preferred as it provides access to all unit values and parameters. Since the Modbus protocol is included within the PAX2D, the PAX Modbus option card, PAXCDC4, should not be used. The PAXCDC1 (RS485), or PAXCDC2 (RS232) card should be used instead.

PARITY BIT



no EVEN odd

Set the parity bit to match that of the other serial communications equipment on the serial link. The unit ignores the parity when receiving data and sets the parity bit for outgoing data. If no parity is selected with 7 bit word length, an additional stop bit is used to force the frame size to 10 bits. Parity is not available if *DATA* is set for 8 bit.

BAUD RATE



1200 4800 19200
 2400 9600 38400

Set the baud rate to match the other serial communications equipment on the serial link. Normally, the baud rate is set to the highest value that all the serial equipment are capable of transmitting and receiving.

UNIT ADDRESS



1 to 247 - Modbus
 0 to 99 - RLC Protocol

Select a Unit Address that does not match an address number of any other equipment on the serial link.

DATA BIT

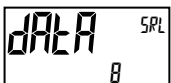

7 8

Select either 7 or 8 bit data word lengths. Set the word length to match the other serial communications equipment on the serial link. For *Modbus* communication type, data bit setting is fixed at 8 bits.

TRANSMIT DELAY



0.000 to 0.250 seconds

Following a Modbus command or RLC Transmit Value command, the PAX2D will wait this minimum amount of time in seconds before issuing a serial response

The following programming steps are only available when Communications Type (TYPE) is programmed for RLC.

ABBREVIATED PRINTING



NO YES

Select NO for full print or Command T transmissions (unit address, mnemonics and parameter data) or YES for abbreviated print transmissions (parameter data only). This will affect all the parameters selected in the print options. If the unit address is 00, it will not be sent during a full transmission.

PRINT OPTIONS



NO YES

YES - Enters the sub-menu to select the unit parameters to appear during a print

request. For each parameter in the sub-menu, select YES for that parameter information to be sent during a print request or NO for that parameter information not to be sent. A print request is sometimes referred to as a block print because more than one parameter information (unit address, mnemonics and parameter data) can be sent to a printer or computer as a block.

DISPLAY	DESCRIPTION	FACTORY SETTING	MNEMONIC
Cnt A	Counter A	YES	CTA
Cnt B	Counter B	NO	CTB
Cnt C	Counter C	NO	CTC
Rate A	Rate A	NO	RTA
Rate B	Rate B	NO	RTB
Rate C	Rate C	NO	RTC
Hi	Max Value	NO	MAX
Lo	Min Value	NO	MIN
SC FRC	Scale Factor A & B	NO	SFA, SFB
Cnt Ld	Counter Load A & B	NO	CLA, CLB
SEt Pnt	Setpoint Values	NO	SP1 - SP4

SERIAL COMMUNICATIONS OVERVIEW

The PAX2 supports serial communications using the optional serial communication cards or via the USB programming port located on the side of the unit. When USB is being used (connected), the serial communication card is disabled. When using the standard RS232 and RS485 PAX2 supports both the RLC protocol and also supports Modbus communications. The PAX Modbus option card should not be used with the PAX2, as the PAX2 internal Modbus protocol supports complete unit configuration, and is much more responsive.

USB

The USB programming port is primarily intended to be used to configure the PAX2D with the Crimson programming software. It can also be used as a virtual serial communications port following installation of the PAX2D USB drivers that are supplied with the Crimson software. When the USB port is being used, i.e. the USB cable is connected between PAX2D and PC, all serial communications with the serial option card (if used) is disabled.

USB Cable type required: USB A to Mini-B (not supplied)

PAX2D CONFIGURATION USING CRIMSON AND USB

1. Install Crimson software.
2. Supply power to PAX2D.
3. Insure USB Configuration (ENF15) in USB Port Parameters is set to AUTO (factory default setting).
4. Attach USB cable (USB A to Mini-B) between PC and PAX2D.
5. Create a new file (File, New) or open an existing PAX2D database within Crimson.
6. Configure Crimson Link options (Link, Options) to the serial port which the USB cable is attached (in Step 4).

SERIAL MODBUS COMMUNICATIONS

Modbus Communications requires that the Serial Communications Type Parameter (TYPE) be set to "mbrtu" or "mbR5C".

PAX2D CONFIGURATION USING CRIMSON AND SERIAL COMMUNICATIONS CARD

1. Install Crimson software.
2. Install RS232 or RS485 card and connect communications cable from PAX2D to PC.
3. Supply power to PAX2D.
4. Configure serial parameters (SERIAL) to Modbus RTU "mbrtu", 38,400 baud, address 247.
5. Create a new file (File, New) or open an existing PAX2D database within Crimson.
6. Configure Crimson Link options (Link, Options) to the serial port which the communication cable is attached (in step 2).

SUPPORTED FUNCTION CODES

FC03: Read Holding Registers

1. Up to 64 registers can be requested at one time.
2. HEX <8000> is returned for non-used registers.

FC04: Read Input Registers

1. Up to 64 registers can be requested at one time.
2. Block starting point can not exceed register boundaries.
3. HEX <8000> is returned in registers beyond the boundaries.
4. Input registers are a mirror of Holding registers.

FC06: Preset Single Register

1. HEX <8001> is echoed back when attempting to write to a read only register.
2. If the write value exceeds the register limit (see Register Table), then that register value changes to its high or low limit. It is also returned in the response.

FC16: Preset Multiple Registers

1. No response is given with an attempt to write to more than 64 registers at a time.
2. Block starting point cannot exceed the read and write boundaries (1-1280).
3. If a multiple write includes read only registers, then only the write registers will change.
4. If the write value exceeds the register limit (see Register Table), then that register value changes to its high or low limit.

FC08: Diagnostics

The following is sent upon FC08 request:

Module Address, 08 (FC code), 04 (byte count), "Total Comms" 2 byte count, "Total Good Comms" 2 byte count, checksum of the string "Total Comms" is the total number of messages received that were addressed to the PAX2. "Total Good Comms" is the total messages received by the PAX2D with good address, parity and checksum. Both counters are reset to 0 upon response to FC08 and at power-up.

FC17: Report Slave ID

The following is sent upon FC17 request:

RLC-PAX2D ab<0100h><40h><40h><10h>
a = SP Card, "0"-No SP, "2" or "4" SP
b = Linear Card "0" = None, "1" = Yes
<0100> Software Version Number (1.00)
<40h>Max Register Reads (64)
<40h>Max Register Writes (64)
<10h> Number Guid/Scratch Pad Regs (16)

SUPPORTED EXCEPTION CODES

01: Illegal Function

Issued whenever the requested function is not implemented in the unit.

02: Illegal Data Address

Issued whenever an attempt is made to access a single register that does not exist (outside the implemented space) or to access a block of registers that falls completely outside the implemented space.

03: Illegal Data Value

Issued when an attempt is made to read or write more registers than the unit can handle in one request.

07: Negative Acknowledge

Issued when a write to a register is attempted with an invalid string length.

PAX2D FREQUENTLY USED MODBUS REGISTERS

Only frequently used registers are shown below. The entire Modbus Register Table can be found at www.redlion.net.

The following is an example of the necessary query and corresponding response for holding register 2. In this example register 2 is the decimal value 123.

Query: 01 03 00 01 00 01 D5 CA

Response: 01 03 02 00 7B F8 67

Notes:

1. The PAX registers can be read as holding (4x) or input (3x) registers.
2. For a value spanning two registers, the portion of the value less than 65,535 will be in (Lo word) register and the portion of the value greater than 65,535 will continue into (Hi word) register. Negative values are represented by two's complement of the combined (Hi word) and (Lo word).
3. The PAX2 should not be powered down while parameters are being changed. Doing so may result in an in-complete write to the non-volatile memory and produce checksum errors.

REGISTER (4x)	REGISTER NAME	LOW LIMIT	HIGH LIMIT	FACTORY SETTING	ACCESS	COMMENTS
1	Counter A Value (Hi word)	-199999999	999999999	0	Read/Write	
2	Counter A Value (Lo word)					
3	Counter B Value (Hi word)	-199999999	999999999	0	Read/Write	
4	Counter B Value (Lo word)					
5	Counter C Value (Hi word)	-199999999	999999999	0	Read/Write	
6	Counter C Value (Lo word)					
7	Rate A Value (Hi word)	N/A	N/A	N/A	Read Only	
8	Rate A Value (Lo word)					
9	Rate B Value (Hi word)	N/A	N/A	N/A	Read Only	
10	Rate B Value (Lo word)					
11	Rate C Value (Hi word)	N/A	N/A	N/A	Read Only	
12	Rate C Value (Lo word)					
13	Max (Hi) Value (Hi word)	-199999	999999	0	Read/Write	
14	Max (Hi) Value (Lo word)					
15	Min (Lo) Value (Hi word)	-199999	999999	0	Read/Write	
16	Min (Lo) Value (Lo word)					
17	Setpoint 1 Value (Hi word)	-199999	999999	100	Read/Write	Active List (A or B)
18	Setpoint 1 Value (Lo word)					
19	Setpoint 2 Value (Hi word)	-199999	999999	200	Read/Write	Active List (A or B)
20	Setpoint 2 Value (Lo word)					
21	Setpoint 3 Value (Hi word)	-199999	999999	300	Read/Write	Active List (A or B)
22	Setpoint 3 Value (Lo word)					
23	Setpoint 4 Value (Hi word)	-199999	999999		Read/Write	Active List (A or B)
24	Setpoint 4 Value (Lo word)					
25	Counter A Scale Factor (Hi word)	1	999999	100000	Read/Write	Active List (A or B)
26	Counter A Scale Factor (Lo word)					
27	Counter B Scale Factor (Hi word)	1	999999	100000	Read/Write	Active List (A or B)
28	Counter B Scale Factor (Lo word)					
29	Counter C Scale Factor (Hi word)	1	999999	100000	Read/Write	Active List (A or B)
30	Counter C Scale Factor (Lo word)					
31	Counter A Count Load (Hi word)	-199999	999999	500	Read/Write	Active List (A or B)
32	Counter A Count Load (Lo word)					
33	Counter B Count Load (Hi word)	-199999	999999	500	Read/Write	Active List (A or B)
34	Counter B Count Load (Lo word)					
35	Counter C Count Load (Hi word)	-199999	999999	500	Read/Write	Active List (A or B)
36	Counter C Count Load (Lo word)					
37	Setpoint Output Register (SOR)	0	15	N/A	Read/Write	Status of Setpoint Outputs. Bit State: 0=Off, 1=On. Bit 3 = S1, Bit 2 = S2, Bit 1 = S3, Bit 0 = S4. Outputs can only be activated/reset with this register when the respective bits in the Manual Mode Register (MMR) are set.
38	Manual Mode Register (MMR)	0	31	0	Read/Write	Bit State: 0 = Auto Mode, 1 = Manual Mode Bit 4 = S1, Bit 3 = S2, Bit 2 = S3, Bit 1 = S4, Bit 0 = Linear Output
39	Reset Output Register	0	15	0	Read/Write	Bit State: 1= Reset Output, bit is returned to zero following reset processing; Bit 3 = S1, Bit 2 = S2, Bit 1 = S3, Bit 0 = S4
40	Analog Output Register (AOR)	0	4095	0	Read/Write	Linear Output Card written to only if Linear Output is in Manual Mode (MMR bit 0 = 1).

SERIAL RLC PROTOCOL COMMUNICATIONS

RLC Communications requires the Serial Communications Type Parameter (*TYPE*) be set to *RLC*.

SENDING SERIAL COMMANDS AND DATA TO THE UNIT

When sending commands to the unit, a string containing at least one command character must be constructed. A command string consists of a command character, a value identifier, numerical data (if writing data to the unit) followed by a command terminator character * or \$. The <CR> is also available as a terminator when Counter C is in the SLAVE mode.

Command Chart

COMMAND	DESCRIPTION	NOTES
N	Node (Unit) Address Specifier	Address a specific unit. Must be followed by a two digit node address. Not required when address = 00.
T	Transmit Value (read)	Read a register from the unit. Must be followed by register ID character
V	Value Change (write)	Write to register of the unit. Must be followed by register ID character and numeric data.
R	Reset	Reset a register or output. Must be followed by register ID character.
P	Block Print Request	Initiates a block print output. Registers are defined in programming.

Command String Construction

The command string must be constructed in a specific sequence. The unit does not respond with an error message to invalid commands. The following procedure details construction of a command string:

- The first characters consist of the Node Address Specifier (N) followed by a 1 or 2 character address number. The address number of the unit is programmable. If the node address is 0, this command and the node address itself may be omitted. For node address 1 through 9, a leading zero character is not required. (The only exception is a numeric transmission when Counter C is set for slave mode.) This is the only command that may be used in conjunction with other commands.
- After the optional address specifier, the next character is the command character.
- The next character is the Register ID. This identifies the register that the command affects. The P command does not require a Register ID character. It prints according to the selections made in print options.
- If constructing a value change command (writing data), the numeric data is sent next.
- All command strings must be terminated with the string termination characters *, \$ or when Counter C is set for slave mode <CR>. The unit does not begin processing the command string until this character is received. See Timing Diagram figure for differences between terminating characters.

Sending Numeric Data

Numeric data sent to the unit must be limited to the digit range shown under transmit details in the Register Identification Chart. Leading zeros are ignored. Negative numbers must have a minus sign. The unit ignores any decimal point and conforms the number to the scaled resolution. (For example: the unit's scaled decimal point position = 0.0 and 25 is written to a register. The value of the register is now 2.5.

Note: Since the unit does not issue a reply to value change commands, follow with a transmit value command for readback verification.

Register Identification Chart

ID	VALUE DESCRIPTION	MNEMONIC	COMMAND	TRANSMIT DETAILS
A	Count A	CTA	T, V, R	9 positive, 8 ½ negative
B	Count B	CTB	T, V, R	9 positive, 8 ½ negative
C	Count C	CTC	T, V, R	9 positive, 8 ½ negative
D	Rate A	RTA	T	6 digit, positive only
E	Rate B	RTB	T	6 digit, positive only
F	Rate C	RTC	T	6 positive, 5 ½ negative
G	Max (Hi) Value	MAX	T, V, R	6 positive, 5 ½ negative
H	Min (Lo) Value	MIN	T, V, R	6 positive, 5 ½ negative
I	Scale Factor A	SFA	T, V	6 digit, positive only
J	Scale Factor B	SFB	T, V	6 digit, positive only
K	Counter Load A	CLA	T, V	6 positive, 5 ½ negative
L	Counter Load B	CLB	T, V	6 positive, 5 ½ negative
M	Setpoint 1	SP1	T, V, R	6 positive, 5 ½ negative
O	Setpoint 2	SP2	T, V, R	6 positive, 5 ½ negative
Q	Setpoint 3	SP3	T, V, R	6 positive, 5 ½ negative
S	Setpoint 4	SP4	T, V, R	6 positive, 5 ½ negative
U	Auto/Manual Register	MMR	T, V	0 – auto, 1 - manual
W	Analog Output Register	AOR	T, V	0 – 4095 normalized
X	Setpoint Register	SOR	T, V	0 – not active, 1 – active

Command String Examples:

- Node address = 17, Write 350 to Setpoint 1.
String: N17VM350\$
- Node address = 5, Read Count A value.
String: N5TA*
- Node address = 0, Reset Setpoint 4 output.
String: RS*

RECEIVING DATA FROM THE UNIT

Data is transmitted by the unit in response to either a transmit command (T), a print block command (P) or User Function print request. The response from the unit is either a full field transmission or an abbreviated transmission. The unit response mode is selected in Serial Port Parameters (*ABRU*).

Full Field Transmission (Address, Mnemonic, Numeric data)

Byte	Description
1, 2	2 byte Node Address field [00-99]
3	<SP> (Space)
4-6	3 byte Register Mnemonic field
7-18	12 byte data field, 10 bytes for number, one byte for sign, one byte for decimal point
19	<CR> carriage return
20	<LF> line feed
21	<SP>* (Space)
22	<CR>* carriage return
23	<LF>* line feed

* These characters only appear in the last line of a block print.

The first two characters transmitted are the node address, unless the node address assigned = 0, in which case spaces are substituted. A space follows the node address field. The next three characters are the register mnemonic.

The numeric data is transmitted next. The numeric field is 12 characters long (to accommodate the 10 digit totalizer), with the decimal point position floating within the data field. Negative values have a leading minus sign. The data field is right justified with leading spaces.

The end of the response string is terminated with a carriage return <CR> and <LF>. When block print is finished, an extra <SP><CR> <LF> is used to provide separation between the blocks.

Abbreviated Transmission (Numeric data only)

Byte	Description
1-12	12 byte data field, 10 bytes for number, one byte for sign, one byte for decimal point
13	<CR> carriage return
14	<LF> line feed
15	<SP>* (Space)
16	<CR>* carriage return
17	<LF>* line feed

* These characters only appear in the last line of a block print.

Unit Response Examples:

- Node address = 17, full field response, Count A = 875
17 CTA 875 <CR><LF>
- Node address = 0, full field response, Setpoint 2 = -250.5
SP2 -250.5<CR><LF>
- Node address = 0, abbreviated response, Setpoint 2 = 250, last line of block print
250<CR><LF><SP><CR><LF>

Auto/Manual Mode Register (MMR) ID: U

This register sets the controlling mode for the outputs. In Auto Mode (0) the unit controls the setpoint and analog output. In Manual Mode (1) the outputs are defined by the registers SOR and AOR. When transferring from auto mode to manual mode, the unit holds the last output value (until the register is changed by a write). Each output may be independently changed to auto or manual. In a write command string (VU), any character besides 0 or 1 in a field will not change the corresponding output mode.

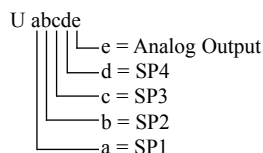

Example: VU00011* places SP4 and Analog in manual.

Analog Output Register (AOR) ID: W

This register stores the present signal value of the analog output. The range of values of this register is 0 to 4095, which corresponds to the analog output range per the following chart:

Register Value	Output Signal*		
	0-20 mA	4-20 mA	0-10 V
0	0.00	4.00	0.000
1	0.005	4.004	0.0025
2047	10.000	12.000	5.000
4094	19.995	19.996	9.9975
4095	20.000	20.000	10.000

*Due to the absolute accuracy rating and resolution of the output card, the actual output signal may differ 0.15% FS from the table values. The output signal corresponds to the range selected (0-20 mA, 4-20 mA or 0-10 V).

Writing to this register (VW) while the analog output is in the Manual Mode causes the output signal level to update immediately to the value sent. While in the Automatic Mode, this register may be written to, but it has no effect until the analog output is placed in the manual mode. When in the Automatic Mode, the unit controls the analog output signal level. Reading from this register (TW) will show the present value of the analog output signal.

Example: VW2047* will result in an output of 10.000 mA, 12.000 mA or 5.000V depending on the range selected.

Setpoint Output Register (SOR) ID: X

This register stores the states of the setpoint outputs. Reading from this register (TX) will show the present state of all the setpoint outputs. A "0" in the setpoint location means the output is off and a "1" means the output is on.

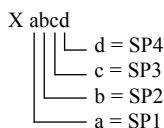

In Automatic Mode, the unit controls the setpoint output state. In Manual Mode, writing to this register (VX) will change the output state. Sending any character besides 0 or 1 in a field or if the corresponding output was not first in manual mode, the corresponding output value will not change. (It is not necessary to send least significant 0s.)

Example: VX10* will result in output 1 on and output 2 off.

COUNTER C SERIAL SLAVE DISPLAY

Counter C may be programmed for *SLAVE* to act as a serial slave display. In this mode, the carriage return <CR> is added as a valid command terminator character for all serial command strings. The <CR> as a terminator may be very useful for standard serial commands, even if Counter C is never displayed or sent a slave message. The <*> and <\$> are also recognized as valid terminators for the serial slave.

The Counter C slave display is right aligned, and has the capacity of displaying six characters on Line 1 or nine characters on Line 2. When less than the full display of characters is received, blank spaces are placed in front of the characters. If more than the full display of characters is received, only the last six (or nine) characters are displayed. The unit has an internal 300 character buffer for the slave display. If more than 300 characters are received, the additional characters are discarded until a <CR> is received. At that point, the last six (or nine) characters in the buffer are displayed.

Counter C processes Numeric and Literal slave transmissions as follows.

Numeric Transmissions

When a string that does not begin with #, T, V, P or R is received, the unit processes it as a Numeric transmission. In this case, only numbers and a minus sign can be displayed. All other characters in the string are discarded. If a minus sign appears anywhere in the string the resulting number will be negative. If a decimal point is desired, it is programmed in Counter C setup and is ignored in the serial string. If no numerical characters are received, then the numeric value will be zero.

The numeric display can be used for setpoint (boundary action only) and analog output functions. The numeric value is retained in Counter C memory until another Numeric transmission is received. If a numeric values is not to be saved to non-volatile memory, send the value as a literal transmission.

Note: Numeric transmissions sent to unit addresses 1 through 9 must have a leading zero character sent with the address (i.e. N01 through N09).

Literal Transmissions

When a string that begins with # is received, the unit processes it as a Literal transmission. In this case, only numeric and alphabetic characters or a minus sign (dash) will be processed. Any other non-alphanumeric character will be discarded. Non-displayable alphabetic characters (M, W and X) will be replaced with a space. A Literal display overrides any Units Mnemonics characters, when shown on Line 2.

A Literal display will replace a Numeric value in the Counter C display. However, it will not remove a previous Numeric value from Counter C memory or prevent the Counter C assigned outputs from functioning with the previous Numeric value.

Displayable Alphabetic Characters:

ASCII	A	B	C	D	E	F	G	H	I	J	K	L	N	O	P	q	r	S	t	U	V	Y	Z
DISPLAY	A	B	C	D	E	F	G	H	I	J	K	L	N	O	P	q	r	S	t	U	V	Y	Z

(Both uppercase and lowercase ASCII characters are accepted.)

Downloading Data from a G3 to a PAX2D

Communications:

Port: RS232 Comms Raw Serial Port
Port Driver: <system> Raw Serial Port

Programming:

PortPrint(2, "N01" + IntToText(Var1, 10, 6) + "\r");

This program is called from the Global On Tick. It sends "N01" (the unit address), followed by the ASCII equivalent of Var1, then a carriage return.

COMMAND RESPONSE TIME

The unit can only receive data or transmit data at any one time (half-duplex operation). When sending commands and data to the unit, a delay must be imposed before sending another command. This allows enough time for the unit to process the command and prepare for the next command.

At the start of the time interval t_1 , the computer program prints or writes the string to the com port, thus initiating a transmission. During t_1 , the command characters are under transmission and at the end of this period, the command terminating character (*) is received by the unit. The time duration of t_1 is dependent on the number of characters and baud rate of the channel.

$$t_1 = (10 * \# \text{ of characters}) / \text{baud rate}$$

At the start of time interval t_2 , the unit starts the interpretation of the command and when complete, performs the command function. This time interval t_2 varies from 2 msec to 15 msec. If no response from the unit is expected, the unit is ready to accept another command.

If the unit is to reply with data, the time interval t_2 is controlled by the use of the command terminating character and the Serial Transmit Delay parameter ($dELAY$). The standard command line terminating character is “*”. This terminating character results in a response time window of the Serial Transmit Delay time ($dELAY$) plus 15 msec. maximum. The $dELAY$ parameter should be programmed to a value that allows sufficient time for the release of the sending driver on the RS485 bus. Terminating the command line with “\$” results in a response time window (t_2) of 2 msec minimum and 15 msec maximum. The response time of this terminating character requires that sending drivers release within 2 msec after the terminating character is received.

At the beginning of time interval t_3 , the unit responds with the first character of the reply. As with t_1 , the time duration of t_3 is dependent on the number of characters and baud rate of the channel.

$$t_3 = (10 * \# \text{ of characters}) / \text{baud rate}$$

At the end of t_3 , the unit is ready to receive the next command. The maximum serial throughput of the unit is limited to the sum of the times t_1 , t_2 and t_3 .

Timing Diagrams

NO REPLY FROM UNIT

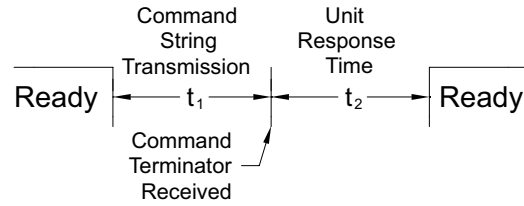

RESPONSE FROM UNIT

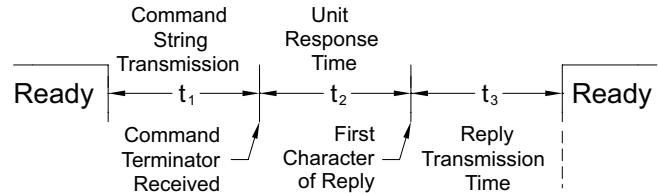

COMMUNICATION FORMAT

Data is transferred from the unit through a serial communication channel. In serial communications, the voltage is switched between a high and low level at a predetermined rate (baud rate) using ASCII encoding. The receiving device reads the voltage levels at the same intervals and then translates the switched levels back to a character.

The voltage level conventions depend on the interface standard. The table lists the voltage levels for each standard.

LOGIC	INTERFACE STATE	RS232*	RS485*
1	mark (idle)	TXD,RXD; -3 to -15 V	a-b < -200 mV
0	space (active)	TXD,RXD; +3 to +15 V	a-b > +200 mV

* Voltage levels at the Receiver

Data is transmitted one byte at a time with a variable idle period between characters (0 to ∞). Each ASCII character is “framed” with a beginning start bit, an optional parity bit and one or more ending stop bits. The data format and baud rate must match that of other equipment in order for communication to take place. The figures list the data formats employed by the unit.

Start bit and Data bits

Data transmission always begins with the start bit. The start bit signals the receiving device to prepare for reception of data. One bit period later, the least significant bit of the ASCII encoded character is transmitted, followed by the remaining data bits. The receiving device then reads each bit position as they are transmitted. Since the sending and receiving devices operate at the same transmission speed (baud rate), the data is read without timing errors.

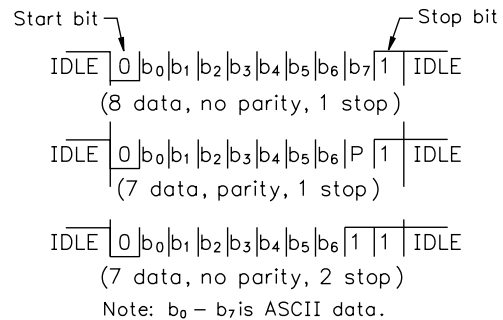

Character Frame Figure

Parity bit

After the data bits, the parity bit is sent. The transmitter sets the parity bit to a zero or a one, so that the total number of ones contained in the transmission (including the parity bit) is either even or odd. This bit is used by the receiver to detect errors that may occur to an odd number of bits in the transmission. However, a single parity bit cannot detect errors that may occur to an even number of bits. Given this limitation, the parity bit is often ignored by the receiving device. The PAX ignores the parity bit of incoming data and sets the parity bit to odd, even or none (mark parity) for outgoing data.

Stop bit

The last character transmitted is the stop bit. The stop bit provides a single bit period pause to allow the receiver to prepare to re-synchronize to the start of a new transmission (start bit of next byte). The receiver then continuously looks for the occurrence of the start bit. If 7 data bits and no parity is selected, then 2 stop bits are sent from the PAX.

6.5 FACTORY SERVICE OPERATIONS (FACTORY)

FACTORY SERVICE CODE



0-250

Enter the Service Code for the desired operation.

RESTORE FACTORY DEFAULTS

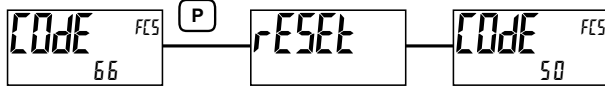

Use the **F1** and **F2** keys to display **Code 66** and press **P**. The unit will flash **RESET** and then return to **Code 50**. Press the **P** key to return to Display Mode. This will overwrite all user settings with the factory settings. The only exception is the User Mnemonics which retain their programmed values (see Code 69).

RESTORE FACTORY DEFAULTS (w/Units Mnemonics)

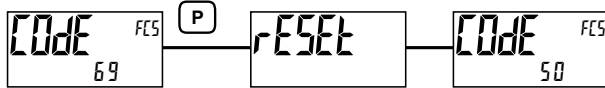

Same as Code 66, except the User Mnemonics are also returned to the factory default settings (blank).

MODEL AND CODE VERSION

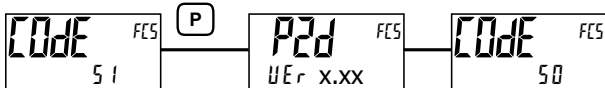

The unit will briefly display the model (**P2d**) on Line 1, and the current firmware version (**UEr x.xx**) on Line 2, and then return to **Code 50**.

INPUT A AND B LOGIC SELECTION



The Count Inputs A and B are factory configured for falling edge triggered (active low) operation in single edge count modes. The Counter Operating Mode descriptions in the Input programming section reflect this logic. If an application is better suited to use rising edge triggered (active high) operation, the Input Logic for Input A and/or Input B can be changed by entering Code 55.



Selecting **HI-ACt** sets the Input A logic to rising edge triggered (active high) operation. Be advised that all references to Input A falling edge and Input A rising edge will be reversed for the Counter Operating Mode descriptions.



Selecting **HI-ACt** sets the Input B logic to rising edge triggered (active high) operation. Be advised that all references to Input B falling edge and Input B rising edge will be reversed for the Counter Operating Mode descriptions.

CALIBRATION

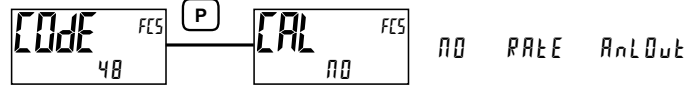

Enter Code 48 and choose Rate or Analog Output calibration.

The only items in the PAX2D that can be calibrated are the Rate Indicator accuracy and the Analog Output. The Rate Indicator is scaled in the Rate Input Parameter programming section. The Analog Output signal is scaled in the Analog Output Parameter section. If the Rate display or the Analog Output appears to be indicating incorrectly or inaccurately, refer to the Troubleshooting section to make sure the unit is properly scaled for the application.

If Rate accuracy or Analog Output recalibration is required (generally every 2 years), it should be performed by qualified technicians using appropriate equipment. Calibration does not change any user programmed parameters.

Note: Allow a 30 minute warm-up period before starting calibration.

Rate Accuracy Calibration

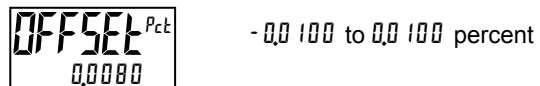

Rate Indicator calibration is done by adjusting the Rate Accuracy Offset value. This value provides a Rate calculation adjustment factor expressed in percent of the display reading. An adjustment range of $\pm 0.01\%$ is provided, which equals ± 1 count for a display reading of 10,000.

The initial offset value is set during factory test. To calibrate, connect a precision signal generator with an accuracy of 0.005% or better to Input A on the PAX2D. (Refer to the Rate Input Parameter programming section for Rate setup details.) Using the Rate A Decimal Point position and Scaling Display parameters, program the unit to read the input frequency with maximum display resolution (i.e. 6-digit display reading). Compare the Rate display to the signal generator output frequency. Adjust the Rate Accuracy Offset value higher (for low Display reading) or lower (for high Display Reading) until the Rate display matches the signal generator.

Analog Output Card Calibration

Before starting, verify that a precision meter with an accuracy of 0.05% or better (voltmeter for voltage output and/or current meter for current output) is connected and ready. Using the chart below, step through the five selections to be calibrated. At each prompt, use the PAX2D **F1** and **F2** keys to adjust the output so that the external meter display matches the selection being calibrated. When the external reading matches, or if the range is not being calibrated, press the **P** key to advance to the next range. When all the desired ranges have been calibrated, exit programming mode and remove the external meters.

DISPLAY	EXTERNAL METER	ACTION
0.000A	0.00 mA	Adjust if necessary, press P
0.004A	4.00 mA	Adjust if necessary, press P
0.020A	20.00 mA	Adjust if necessary, press P
0.0V	0.00 V	Adjust if necessary, press P
10.0V	10.00 V	Adjust if necessary, press P

TROUBLESHOOTING

PROBLEM	REMEDIES
No Display At Power-Up	Check power level and power connections.
No Display After Power-Up	Check Display Module: <i>d-LEU</i> , <i>d-Ent</i> , and <i>LINE 1</i> program settings.
Program Locked-Out	Check for Active User Input, programmed for <i>PLDC</i> . Deactivate User Input. Enter proper access code at <i>CODE</i> prompt. (Universal access code = 222)
No Line 1 Display	Check program settings for Line 1 Display Value Select/Enable. Confirm at least one Line 1 Display Value is enabled (4E5).
No Line 2 Display	Check program settings for Line 2 Value Access. Confirm at least one Line 2 Parameter Value is enabled in Main Display Loop (<i>d-rERd</i> , <i>d-rSt</i> , <i>d-Ent</i>).
No Line 1 Units Mnemonic Display	Check program settings for Line 1 Units Mnemonic(s).
Display of <i>OUER</i> or <i>UndEr</i>	Value exceeds Display capacity of the unit. See General Meter Specifications.
Incorrect Display Value or Not Counting	Check Input wiring, DIP switch setting, Input programming, Scale Factor calculation, Input signal level, User Input Logic setting, lower input signal frequency.
User Input Not Functioning	Check User Input wiring, User Logic setting, User Function settings, User Input being used as a signal input in dual count modes (see Counter Operating Modes).
Modules or Parameters Not Accessible	Check for corresponding option card. Verify parameter is valid in regard to previous program settings.
Error Code: <i>ErrKEY</i>	Keypad is active at power up. Check for depressed or stuck keypad. Press any key to clear Error Code.
Error Code: <i>EE PAR</i> Error Code: <i>EE Pdn</i>	Parameter Data Checksum Error. Press any key to clear Error Code, verify all program settings and cycle power. Contact factory if Error Code returns at next power-up.
Error Code: <i>ErrPrd</i>	Parameter Data Validation Error. Press any key to clear Error Code, verify all program settings and cycle power. Contact factory if Error Code returns at next power-up.
Error Code: <i>EE Lin</i>	Linear Output Card Data Validation Error. Press any key to clear Error Code and cycle power. If Error Code returns at next power-up, replace Linear Option Card or contact factory.

PARAMETER VALUE CHART PAX2D

Programmer _____ Date _____
Unit# _____ Security Code _____

INPUT SETUP PARAMETERS

COUNTER Counter Parameters

DISPLAY	PARAMETER	USER SETTING	DISPLAY	PARAMETER	USER SETTING
COUNTER A PARAMETERS			<i>dEC Pt</i>	Rate A Decimal Position	_____
<i>Ent A</i>	Counter A Operating Mode	_____	<i>SC PtS</i>	Rate A Scaling Points	_____
<i>dEC Pt</i>	Counter A Decimal Position	_____	<i>RRxdSP 1</i>	Rate A Scaling Point 1 Display	_____
<i>SC FAE</i>	Counter A Scale Factor	_____	<i>RR INP 1</i>	Rate A Scaling Point 1 Input	_____
<i>SCALEr</i>	Counter A Scale Multiplier	_____	<i>RRxdSP 2</i>	Rate A Scaling Point 2 Display	_____
<i>RESET</i>	Counter A Reset Action	_____	<i>RR INP 2</i>	Rate A Scaling Point 2 Input	_____
<i>Ent Ld</i>	Counter A Count Load Value	_____	<i>RRxdSP 3</i>	Rate A Scaling Point 3 Display	_____
<i>R P-UP</i>	Counter A Reset At Power-Up	_____	<i>RR INP 3</i>	Rate A Scaling Point 3 Input	_____
<i>PS Out</i>	Prescaler Output Enable	_____	<i>RRxdSP 4</i>	Rate A Scaling Point 4 Display	_____
<i>PS SCL</i>	Prescaler Scale Value	_____	<i>RR INP 4</i>	Rate A Scaling Point 4 Input	_____
COUNTER B PARAMETERS			<i>RRxdSP 5</i>	Rate A Scaling Point 5 Display	_____
<i>Ent b</i>	Counter B Operating Mode	_____	<i>RR INP 5</i>	Rate A Scaling Point 5 Input	_____
<i>dEC Pt</i>	Counter B Decimal Position	_____	<i>RRxdSP 6</i>	Rate A Scaling Point 6 Display	_____
<i>SC FAE</i>	Counter B Scale Factor	_____	<i>RR INP 6</i>	Rate A Scaling Point 6 Input	_____
<i>SCALEr</i>	Counter B Scale Multiplier	_____	<i>RRxdSP 7</i>	Rate A Scaling Point 7 Display	_____
<i>RESET</i>	Counter B Reset Action	_____	<i>RR INP 7</i>	Rate A Scaling Point 7 Input	_____
<i>Ent Ld</i>	Counter B Count Load Value	_____	<i>RRxdSP 8</i>	Rate A Scaling Point 8 Display	_____
<i>R P-UP</i>	Counter B Reset At Power-Up	_____	<i>RR INP 8</i>	Rate A Scaling Point 8 Input	_____
COUNTER C PARAMETERS			<i>RRxdSP 9</i>	Rate A Scaling Point 9 Display	_____
<i>Ent C</i>	Counter C Operating Mode	_____	<i>RR INP 9</i>	Rate A Scaling Point 9 Input	_____
<i>dEC Pt</i>	Counter C Decimal Position	_____	<i>RRxdSP 10</i>	Rate A Scaling Point 10 Display	_____
<i>SC FAE</i>	Counter C Scale Factor	_____	<i>RR INP 10</i>	Rate A Scaling Point 10 Input	_____
<i>SCALEr</i>	Counter C Scale Multiplier	_____	<i>ROUND</i>	Rate A Display Rounding	_____
<i>RESET</i>	Counter C Reset Action	_____	<i>LO-Cut</i>	Rate A Low Cut-Out	_____
<i>Ent Ld</i>	Counter C Count Load Value	_____	RATE B PARAMETERS		
<i>R P-UP</i>	Counter C Reset At Power-Up	_____	<i>RALE b</i>	Rate B Enable	_____
RATE A PARAMETERS			<i>dEC Pt</i>	Rate B Decimal Position	_____
<i>RALE A</i>	Rate A Enable	_____	<i>SC PtS</i>	Rate B Scaling Points	_____
RATE B PARAMETERS			<i>RbxdsP 1</i>	Rate B Scaling Point 1 Display	_____
<i>DISPLAY</i>	PARAMETER	USER SETTING	<i>Rb INP 1</i>	Rate B Scaling Point 1 Input	_____
<i>RALE A</i>	Rate A Enable	_____	<i>RbxdsP 2</i>	Rate B Scaling Point 2 Display	_____
			<i>Rb INP 2</i>	Rate B Scaling Point 2 Input	_____

DISPLAY	PARAMETER	USER SETTING	DISPLAY	PARAMETER	USER SETTING
<i>PbxdSP 3</i>	Rate B Scaling Point 3 Display	_____		RATE C PARAMETERS	
<i>Pb INP 3</i>	Rate B Scaling Point 3 Input	_____	<i>RATE C</i>	Rate C Calculation	_____
<i>PbxdSP 4</i>	Rate B Scaling Point 4 Display	_____	<i>SCALEr</i>	Rate C Display Multiplier	_____
<i>Pb INP 4</i>	Rate B Scaling Point 4 Input	_____	<i>dEC Pt</i>	Rate C Decimal Position	_____
<i>PbxdSP 5</i>	Rate B Scaling Point 5 Display	_____		RATE UPDATE PARAMETERS	
<i>Pb INP 5</i>	Rate B Scaling Point 5 Input	_____	<i>LO-Udt</i>	Rate Low Update Time	_____
<i>PbxdSP 6</i>	Rate B Scaling Point 6 Display	_____	<i>HI-Udt</i>	Rate High Update Time	_____
<i>Pb INP 6</i>	Rate B Scaling Point 6 Input	_____		RATE MAX AND MIN CAPTURE	
<i>PbxdSP 7</i>	Rate B Scaling Point 7 Display	_____	<i>H1 ASN</i>	Max Capture Value Assignment	_____
<i>Pb INP 7</i>	Rate B Scaling Point 7 Input	_____	<i>H1 CAP</i>	Max Capture Delay Time	_____
<i>PbxdSP 8</i>	Rate B Scaling Point 8 Display	_____	<i>Lo ASN</i>	Min Capture Value Assignment	_____
<i>Pb INP 8</i>	Rate B Scaling Point 8 Input	_____	<i>Lo CAP</i>	Min Capture Delay Time	_____
<i>PbxdSP 9</i>	Rate B Scaling Point 9 Display	_____		User Input Parameters	
<i>Pb INP 9</i>	Rate B Scaling Point 9 Input	_____	DISPLAY	PARAMETER	USER SETTING
<i>PbxdSP 10</i>	Rate B Scaling Point 10 Display	_____	<i>USRAct</i>	User Active State	_____
<i>Pb INP 10</i>	Rate B Scaling Point 10 Input	_____	<i>USER-1</i>	User Input 1	_____
<i>ROUND</i>	Rate B Display Rounding	_____	<i>USER-2</i>	User Input 2	_____
<i>LO-Cut</i>	Rate B Low Cut-Out	_____	<i>USER-3</i>	User Input 3	_____
			<i>F1</i>	Function Key 1	_____
			<i>F2</i>	Function Key 2	_____
			<i>SEC-F1</i>	2nd Function Key 1	_____
			<i>SEC-F2</i>	2nd Function Key 2	_____

OUTPUT OUTPUT PARAMETERS

SETPOINT Setpoint Output Parameters

DISPLAY	PARAMETER	USER SETTING	USER SETTING	USER SETTING	USER SETTING
		S1	S2	S3	S4
<i>SELECT</i>	Setpoint Selection	_____	_____	_____	_____
<i>ASSIGN</i>	Setpoint Source	_____	_____	_____	_____
<i>ACT: ON</i>	Action For Setpoint	_____	_____	_____	_____
<i>LOGIC</i>	Output Logic	_____	_____	_____	_____
<i>Annun</i>	Output Annunciator Light	_____	_____	_____	_____
<i>Co lor</i>	Change Color	_____	_____	_____	_____
<i>SETPnt</i>	Setpoint Value	_____	_____	_____	_____
<i>TrAC</i>	Setpoint Tracking	_____	_____	_____	_____
<i>P-UP</i>	Setpoint Output Power-Up State	_____	_____	_____	_____
<i>TYPE</i>	Setpoint Activation Type	_____	_____	_____	_____
<i>Stby</i>	Standby Operation	_____	_____	_____	_____
<i>HYSL</i>	Hysteresis For Setpoint	_____	_____	_____	_____
<i>t-ON</i>	On Time Delay Setpoint	_____	_____	_____	_____
<i>t-OFF</i>	Off Time Delay Setpoint	_____	_____	_____	_____
<i>t-OUT</i>	Setpoint Output Time-Out	_____	_____	_____	_____
<i>1-SHOT</i>	Rate Timed Output One-Shot	_____	_____	_____	_____
<i>Auto</i>	Counter Auto Reset	_____	_____	_____	_____
<i>RESET</i>	Output Reset W/ Counter Reset	_____	_____	_____	_____
<i>Res-tSn</i>	Setpoint Output Reset At Sn+1	_____	_____	_____	_____

ANALOG Analog Output Parameters

DISPLAY	PARAMETER	USER SETTING	DISPLAY	PARAMETER	USER SETTING
<i>TYPE</i>	Analog Type	_____	<i>Addr</i>	Unit Address	_____
<i>ASSIGN</i>	Analog Assignment	_____	<i>dELAY</i>	Transmit Delay	_____
<i>LO-SEL</i>	Analog Low	_____	<i>Abro</i>	Abbreviated Printing	_____
<i>HI-SEL</i>	Analog High	_____	<i>OPT</i>	Print Options	_____

Port COMMS. PORT PARAMETERS

USB USB Port Parameters

DISPLAY	PARAMETER	USER SETTING	DISPLAY	PARAMETER	USER SETTING
<i>CONF G</i>	USB Configuration	_____	<i>Rate A</i>	Counter A	_____

Serial Serial Port Parameters

DISPLAY	PARAMETER	USER SETTING	DISPLAY	PARAMETER	USER SETTING
<i>TYPE</i>	Communications Type	_____	<i>Rate b</i>	Counter B	_____
<i>baud</i>	Baud Rate	_____	<i>Rate c</i>	Counter C	_____
<i>dAtA</i>	Data Bits	_____	<i>RATE A</i>	Rate A	_____
<i>PARiTY</i>	Parity Bit	_____	<i>RATE b</i>	Rate B	_____
			<i>RATE c</i>	Rate C	_____
			<i>H1</i>	Rate Maximum	_____
			<i>Lo</i>	Rate Minimum	_____
			<i>SC FAc</i>	Scale Factor A & B	_____
			<i>Cnt Ld</i>	Counter Load A & B	_____
			<i>SETPnt</i>	Setpoint Values	_____

di SPLY DISPLAY PARAMETERS

LINE 1 Line 1 Parameters

DISPLAY	PARAMETER	USER SETTING
<i>Co lor</i>	Line 1 Display Color	_____
<i>d-LEU</i>	Display Level	_____
<i>d-Cont</i>	Display Contrast Level	_____
SELECT	Line 1 Display Value Select	
	<i>Ent A</i> _____	<i>PRtE b</i> _____
	<i>Ent b</i> _____	<i>PRtE c</i> _____
	<i>Ent c</i> _____	<i>H i</i> _____
	<i>PRtE A</i> _____	<i>Lo</i> _____
<i>ScroLL</i>	Line 1 Display Scroll Enable/Time	_____
UNIT5	Line 1 Units Mnemonic(s)	_____

LABEL MNEMONIC	LABEL
	List A List B

<i>Unit 1</i>	Line 1 Units Digit 1 (Left)	_____
<i>Unit 2</i>	Line 1 Units Digit 2 (Center)	_____
<i>Unit 3</i>	Line 1 Units Digit 3 (Right)	_____

LIST A CUSTOM MNEMONICS	<i>Unit 1</i>	<i>Unit 2</i>	<i>Unit 3</i>
Counter A	_____	_____	_____
Counter B	_____	_____	_____
Counter C	_____	_____	_____
Rate A	_____	_____	_____
Rate B	_____	_____	_____
Rate C	_____	_____	_____
Max (HI)	_____	_____	_____
Min (LO)	_____	_____	_____

LIST B CUSTOM MNEMONICS	<i>Unit 1</i>	<i>Unit 2</i>	<i>Unit 3</i>
Counter A	_____	_____	_____
Counter B	_____	_____	_____
Counter C	_____	_____	_____
Rate A	_____	_____	_____
Rate B	_____	_____	_____
Rate C	_____	_____	_____
Max (HI)	_____	_____	_____
Min (LO)	_____	_____	_____

LINE 2 Line 2 Parameters

ACCESS	LINE 2 VALUE ACCESS
<i>Ent A</i>	_____ <i>S3</i> _____
<i>Ent b</i>	_____ <i>S4</i> _____
<i>Ent c</i>	_____ <i>SE FAE cEtA</i> _____
<i>PRtE A</i>	_____ <i>SE FAE cEtb</i> _____
<i>PRtE b</i>	_____ <i>SE FAE cEtC</i> _____
<i>PRtE c</i>	_____ <i>Ent Ld cEtA</i> _____
<i>H i</i>	_____ <i>Ent Ld cEtb</i> _____
<i>Lo</i>	_____ <i>Ent Ld cEtC</i> _____
<i>LISt</i>	_____ <i>Co lor</i> _____
<i>S1</i>	_____ <i>d-LEU</i> _____
<i>S2</i>	_____ <i>d-Cont</i> _____

FUNCt	LINE 2 FUNCTIONS ACCESS
<i>r-L1</i>	_____ <i>r-H i</i> _____
<i>r-cEtA</i>	_____ <i>r-Lo</i> _____
<i>r-cEtb</i>	_____ <i>r-HL</i> _____
<i>r-cEtC</i>	_____ <i>Pr int</i> _____
<i>r-PRtE</i>	_____ _____

<i>ScroLL</i>	Line 2 Display Scroll Enable/Time	_____
---------------	-----------------------------------	-------

UNIT5

Line 2 Units Mnemonic(s)	LABEL
LABEL MNEMONIC	List A List B
<i>Unit 1</i>	Line 2 Units Digit 1 (Left)
<i>Unit 2</i>	Line 2 Units Digit 2
<i>Unit 3</i>	Line 2 Units Digit 3
<i>Unit 4</i>	Line 2 Units Digit 4
<i>Unit 5</i>	Line 2 Units Digit 5
<i>Unit 6</i>	Line 2 Units Digit 6
<i>Unit 7</i>	Line 2 Units Digit 7
<i>Unit 8</i>	Line 2 Units Digit 8
<i>Unit 9</i>	Line 2 Units Digit 9 (Right)

LIST A CUSTOM MNEMONICS

	1	2	3	4	5	6	7	8	9
Counter A									
Counter B									
Counter C									
Rate A									
Rate B									
Rate C									
Max (HI)									
Min (LO)									

LIST B CUSTOM MNEMONICS

	1	2	3	4	5	6	7	8	9
Counter A									
Counter B									
Counter C									
Rate A									
Rate B									
Rate C									
Max (HI)									
Min (LO)									

CODE

Security Code _____

This page intentionally left blank.

PAX2D PROGRAMMING QUICK OVERVIEW

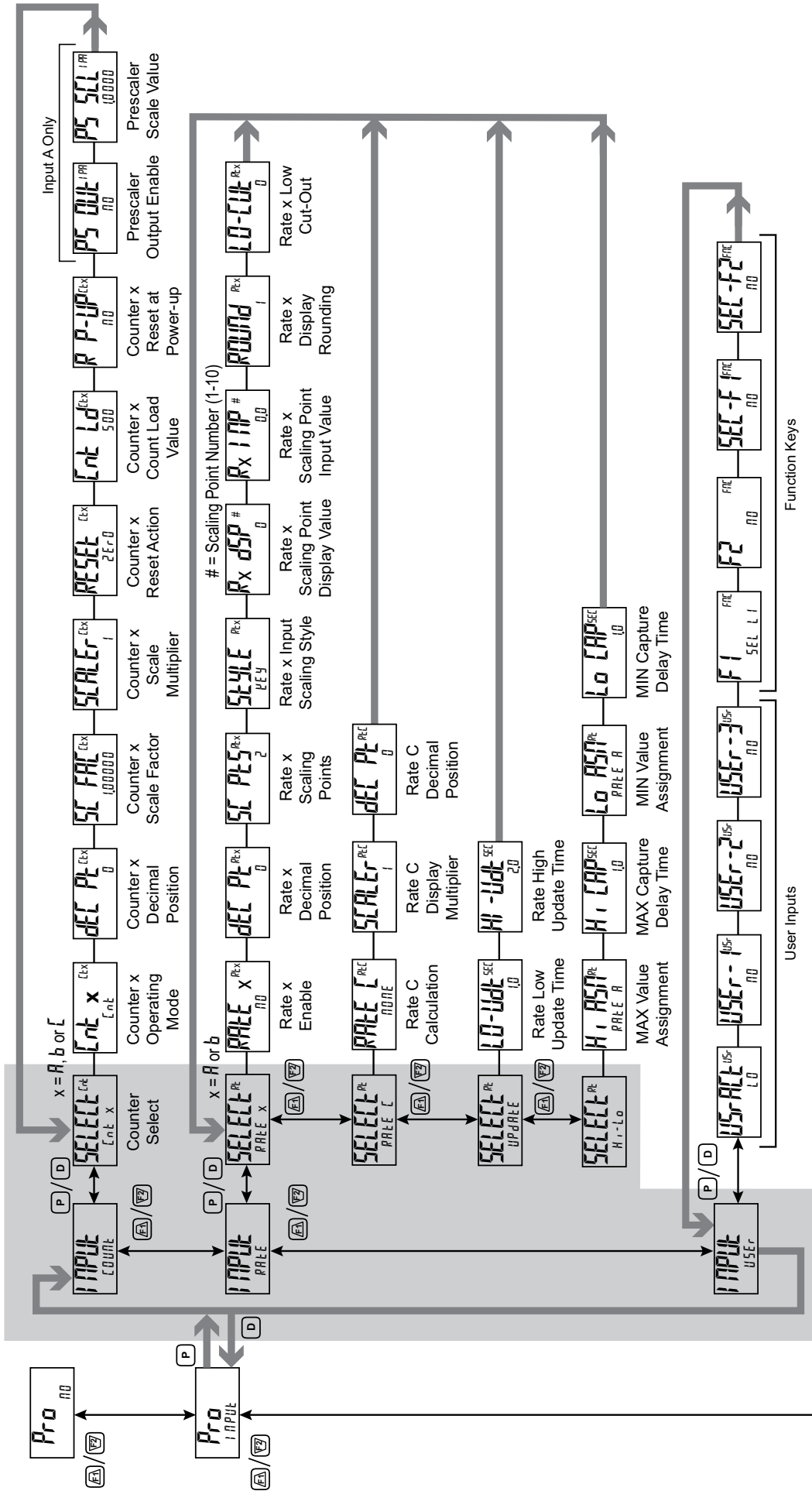

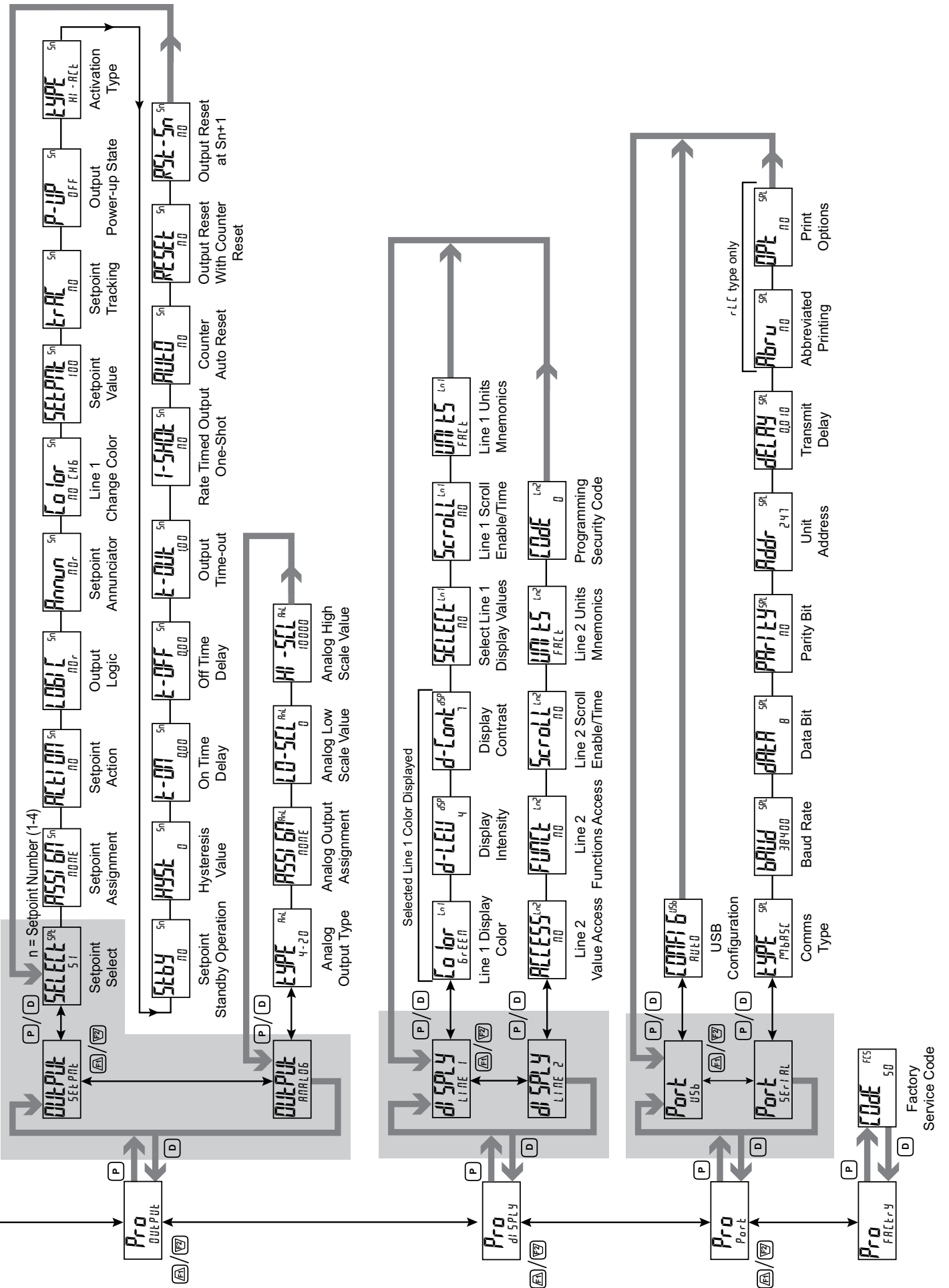

LIMITED WARRANTY

(a) Red Lion Controls Inc., Sixnet Inc., N-Tron Corporation, or Blue Tree Wireless Data, Inc. (the "Company") warrants that all Products shall be free from defects in material and workmanship under normal use for the period of time provided in "Statement of Warranty Periods" (available at www.redlion.net) current at the time of shipment of the Products (the "Warranty Period"). **EXCEPT FOR THE ABOVE-STATED WARRANTY, COMPANY MAKES NO WARRANTY WHATSOEVER WITH RESPECT TO THE PRODUCTS, INCLUDING ANY (A) WARRANTY OF MERCHANTABILITY; (B) WARRANTY OF FITNESS FOR A PARTICULAR PURPOSE; OR (C) WARRANTY AGAINST INFRINGEMENT OF INTELLECTUAL PROPERTY RIGHTS OF A THIRD PARTY; WHETHER EXPRESS OR IMPLIED BY LAW, COURSE OF DEALING, COURSE OF PERFORMANCE, USAGE OF TRADE OR OTHERWISE.** Customer shall be responsible for determining that a Product is suitable for Customer's use and that such use complies with any applicable local, state or federal law.

(b) The Company shall not be liable for a breach of the warranty set forth in paragraph (a) if (i) the defect is a result of Customer's failure to store, install, commission or maintain the Product according to specifications; (ii) Customer alters or repairs such Product without the prior written consent of Company.

(c) Subject to paragraph (b), with respect to any such Product during the Warranty Period, Company shall, in its sole discretion, either (i) repair or replace the Product; or (ii) credit or refund the price of Product provided that, if Company so requests, Customer shall, at Company's expense, return such Product to Company.

(d) **THE REMEDIES SET FORTH IN PARAGRAPH (c) SHALL BE THE CUSTOMER'S SOLE AND EXCLUSIVE REMEDY AND COMPANY'S ENTIRE LIABILITY FOR ANY BREACH OF THE LIMITED WARRANTY SET FORTH IN PARAGRAPH (a).**

Red Lion Controls
Headquarters
20 Willow Springs Circle
York PA 17406
Tel +1 (717) 767-6511
Fax +1 (717) 764-0839

Red Lion Controls
Europe
Softwareweg 9
NL - 3821 BN Amersfoort
Tel +31 (0) 334 723 225
Fax +31 (0) 334 893 793

Red Lion Controls
India
201-B, 2nd Floor, Park Centra
Opp 32 Mile Stone, Sector-30
Gurgaon-122002 Haryana, India
Tel +91 984 487 0503

Red Lion Controls
China
Unit 1102, XinMao Plaza
Building 9, No.99 Tianzhou Road
ShangHai, P.R. China 200223
Tel +86 21 6113 3688
Fax +86 21 6113 3683

X-ON Electronics

Largest Supplier of Electrical and Electronic Components

Click to view similar products for [Red Lion manufacturer](#):

Other Similar products are found below :

[CUB5B000](#) [IFMA0035](#) [LD400400](#) [MLPS2000](#) [508TX-A](#) [PAXLVA00](#) [ZBH06002](#) [CUB4CL20](#) [CUB4LP40](#) [SLX-8ES-1](#) [TORF1000](#)
[WF1000BF](#) [EB-PD-24V-1](#) [FANWAND721SMA](#) [FCOPPER-SFP-100](#) [NTSFP-LX-10](#) [PSDR060W](#) [308TX](#) [508TX](#) [CUB5SNK0](#) [PAXLCR00](#)
[CRM000CMCMOD0000](#) [CRM000CMJ1939000](#) [CR10000700000210](#) [CR10001000000210](#) [CR30000400000310](#) [CR30000700000420](#)
[CR30001000000420](#) [CRM000CMCAN00000](#) [PAXDP000](#) [NT24K-16M12-POE](#) [NT24K-16M12-POE-PT](#) [NT24K-16M12-POE-R](#) [NT24K-](#)
[16M12-POE-R-PT](#) [NT24K-16M12-PT](#) [NT24K-16M12-R](#) [NT24K-16M12-R-PT](#) [IAMA6262](#) [CUB5PB00](#) [FMFIBER-SFP-4K](#) [PAXLA000](#)
[LSAHC001](#) [CBLGEN01](#) [CUB5USB0](#) [516TX](#) [1002MC-SX](#) [102MCE-SC-15](#) [105FX-ST](#) [106FX2-ST](#) [304TX](#)