

ALLIGATOR® Solid-Wall Anchors

Heavy-duty anchoring in concrete & brick ... even in tile!

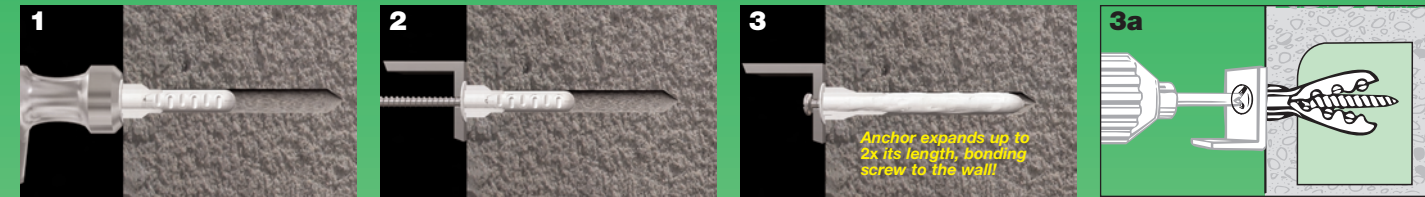

1 Drill hole same diameter as anchor. Push in anchor and tap flush.
 2 Place item over anchor, insert screw and tighten flush with item.
 3 Anti-rotation fins prevent spinning while the ALLIGATOR anchor expands along the screw in solid walls ... up to 2x its original length.
 3a In unexpected cavities or in hollow walls (hollow brick, hollow block, tile over drywall, etc.), the screw opens the anchor and its thread locks into the anchor's teeth.

Benefits:

- **Strongest**—holds up to 2x more than metal, adhesive, epoxy, and chemical anchors*
- Anchor bonds screw to concrete, brick & stone—*sealing the hole* [prevents moisture from entering hole]
- Sets instantly • Non-toxic • Rustproof • No-shelf life worry
- Resists vibration & shock in both solid & hollow walls
- Can use a screw gun—anti-rotation fins prevent spinning
- **Greatest screw range** for each anchor: [see Specifications chart below]
- **More versatile** than metal or chemical anchors—holds securely even in *hollow walls / ceilings*

* with the same screw diameter and embedment depth

Ultimate Load in Pounds

Anchor & drill dia.:	3/16"	1/4"	5/16"	3/8"
Anchor:	A5/AF5	A6/AF6	A8/AF8	A10
Tensile				
4000 psi Concrete	2,316	2,633	3,083	4,270
1/2" Drywall	57	69	85	N/A
Shear				
1/2" Drywall	125	153	171	N/A

Specifications:

UNC				
Anchor:	A5/AF5	A6/AF6	A8/AF8	A10
Anchor & drill diameter:	3/16"	1/4"	5/16"	3/8"
Screw sizes:	#4 - #10	#6 - #14	#8 - 5/16"	#10 - 3/8"
Minimum hole depth:	1 1/2"	1 3/4"	2"	2 1/2"
Metric				
Anchor & drill diameter:	5mm	6mm	8mm	10mm
Screw sizes:	Ø3 - 5mm	Ø3.5 - 6mm	Ø4 - 8mm	Ø4.5 - 10mm
Minimum hole depth:	40mm	45mm	50mm	65mm

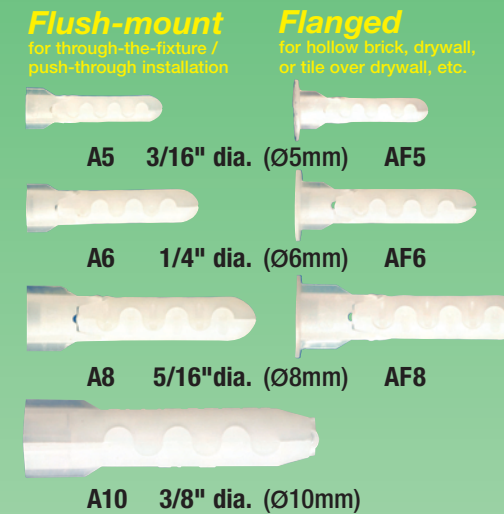

For Maximum Holding in:

- Concrete
- Brick
- Stone
- Masonry
- Cinder block
- Aerated concrete
- Wood
- Stucco
- Plaster
- Tile
- Drywall
- Greenboard
- RTA furniture
- Foam insulated panels

Ideal for Mounting:

- Electrical equipment
- Lighting fixtures
- Plumbing fixtures
- Partitions
- Hand rails & grab bars
- Telephone equipment
- Shelving
- Cabinets
- Awnings
- Circuit breakers
- Framing
- Alarms
- Signs
- DSS antennas
- Fire extinguishers
- Window frames
- Door jambs
- Transformers
- Storefront gates
- Smoke detectors

TOGGLER® Specialty Anchors

Simplify specialized installations!

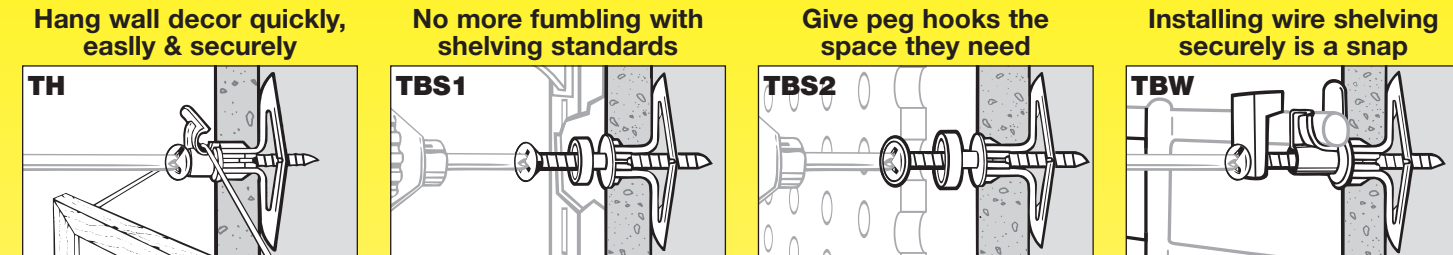

TH Hang wall decor quickly, easily & securely. Specially designed built-in hook holds the weight of the picture on the screw—*not* below it. This provides maximum holding and prevents pull-out! Ideal for hanging paintings, prints, mirrors, and anything framed.

TBS1 No more fumbling with shelving standards. Built-in spacer prevents the anchor from being jacked out of the wall during installation. Also useful installing equipment on warm or wet walls when ventilation is needed behind the installed object.

TBS2 Give peg hooks the space they need. Built-in spacer holds the pegboard the proper distance from the wall to allow peg hooks to work. This eliminates the need for furring strips, saving time & money, and allows full use of the pegboard space.

TBW Installing wire shelving securely is a snap. Includes a locking retainer clip so shelves don't tip, even when the load they support is distributed unevenly or near the edge. Ideal for use with systems like ClosetMaid®. Perfect for closet systems & kitchen, garage or workshop shelves.

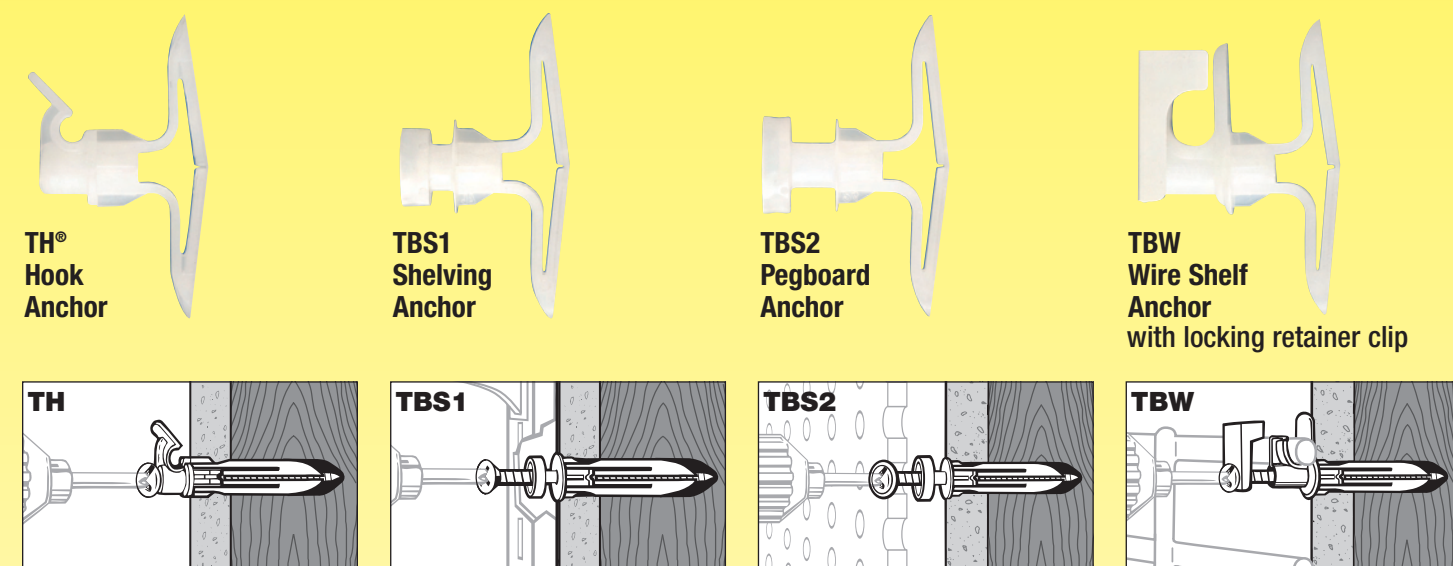

All TOGGLER specialty anchors hold securely, even if you hit a solid area, like a stud ... or in concrete, brick & stone.

Industry safety standards recommend 1/4 of ultimate test load. See MPC technical bulletins for full results of tests and for safety factors that should be applied when evaluating an application ... also for proper screw sizes and lengths.

All pull-out values are from independent laboratory tests done according to U.S. Government standards. They should be used as guides only. The age, condition, and capacity of the substrate must be considered.

Holding strength for a TOGGLER BRAND anchor varies directly with the strength of the wall material, the screw size & the extent of the screw engagement—and inversely with variations in hole diameter and the distance of the load from the wall.

ALL TOGGLER BRAND anchors are proudly made in the USA

www.togglers.com
 Installation videos & technical bulletins

Satisfaction Guaranteed

TOGGLER Anchor System is proud of its unique, patented anchors, but if they fail to perform to your satisfaction, please send the sales receipt together with any unused anchors for a full refund. Your comments would be appreciated. This guarantee is not to be construed as conferring any liability beyond the purchase price of the product.



MECHANICAL PLASTICS CORP.
 P.O. Box 554 • 444 Saw Mill River Road
 Elmsford, NY 10523 USA
 1-888-TOGGLER [1-888-864-4537]
 Fax: (914-347-3634) Tel: (914)347-2727
 Email: info@togglers.com

TOGGLER anchors are patented under one or more of U.S. Patent Nos. 4,993,901; 5,028,186; 5,161,296; 5,938,385; 6,161,999; 7,144,212; and foreign counterparts thereof and of 4,650,386; 4,673,150; 4,752,170; and 4,878,790. Other patents pending. TOGGLER and typeface, logo symbol, TA, TB, TC, TH, SNAPTOGGLE, SnapSku, and ALLIGATOR are worldwide registered trademarks of Mechanical Plastics Corp. ClosetMaid is a registered trademark of ClosetMaid, a division of Emerson™ Electric. Masonite is a registered trademark of Masonite International Corp. © 2007 Mechanical Plastics Corp. Printed in the USA 0907CAT

TOGGLER® High-Performance™ Anchors

Fast, easy & secure anchoring in ALL building materials

	Hollow Materials Drywall, Plaster, Block...	Solid Materials Concrete, Brick, Stone...	
HEAVY Duty Large TV's, Mirrors, Bookshelves, Sinks, Cabinets...	SNAPTOGGLE® Toggle Bolts 	ALLIGATOR® Solid-Wall Anchors 	HEAVY Duty Lighting fixtures, Plumbing fixtures, Partitions, Grab bars, Shelving, Cabinets...
MEDIUM Duty Bathroom accessories, Window treatments, Speaker mounts...	TOGGLER® Plastic Toggle Anchors 		to LIGHT Duty Alarms, Thermostats, Smoke detectors...
MEDIUM - LIGHT Duty Small lighting fixtures, Picture frames...	SnapSku® Regular Self-Drilling Drywall Anchors 	In All Walls ... Hollow and Solid ... Drywall to Concrete TOGGLER® Anchors for Special Projects 	
LIGHT Duty Alarms, Thermostats, Smoke detectors...	SnapSku® MINI Self-Drilling Drywall Anchors 	Picture Hook Shelving Pegboard Wire Shelf	

SNAPTOGGLE® Heavy-Duty Toggle Bolts

Like having an extra pair of hands behind the wall!

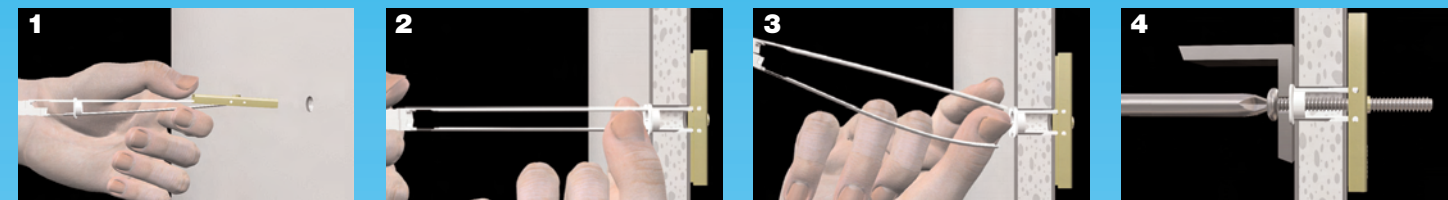

1 Drill hole. Hold metal channel flat alongside plastic straps & slide channel through the hole. Minimum clearance behind wall: only 1 7/8" (48mm).

2 Hold ends of straps together between thumb & forefinger and pull toward you until channel rests behind wall. Ratchet cap along straps with other hand until flange of cap is flush with wall.

3 Place thumb between straps at wall. Push thumb side to side, snapping off straps level with flange of cap.

4 Place item over flange. Insert bolt and tighten until snug against item, then stop. Use machine screw or bolt to match thread in metal channel.

Benefits:

- **Strong**—up to **2x the load** of an old-fashioned wing toggle
Solid metal channel resists vibration & shock
- **Save time**—at least **6 minutes** per anchor v. wing toggles
Can use a screw gun; anchor does not spin
- **Save money**—turn a 2-person job into a 1-person job
Use a shorter bolt (no need to carry a wing through the wall)
- **New strap design snaps off flush & does not break** prematurely
- **Smallest** installation hole for each bolt size
- **New golden plating is 7x more corrosion-resistant**
- **Reusable** in same hole—remove bolt without losing the anchor

Ultimate Tensile Load in Pounds

Thread:	3/16"-24	1/4"-20	5/16"-18	3/8"-16	1/2"-13
Anchor:	BA	BB	BE	BC	BD
1/2" Drywall	238	265	270	275	275
5/8" Drywall	356	356	480	576	576
Concrete block	802	1,080	1,400	1,745	2,038
Steel plate	918	1,283	1,680	1,692	2,605
Drill diameter:	1/2"	1/2"	3/4"	3/4"	3/4"
Grip range:	3/8"-3 5/8"	3/8"-3 5/8"	3/8"-2 1/2"	3/8"-2 1/2"	3/8"-2 1/2"
Long strap code:	BAL	BBL			
Grip range:	2"-9 1/2"	2"-9 1/2"			

These results are for zinc-plated steel anchors. Stainless steel channels with stainless steel bolts held greater loads in concrete & in steel plate. Long straps for roofing and for very thick walls. NOTE: 10-24 = 3/16"-24 Bolt length = item thickness + wall thickness + 1/2" (13mm).

Metric sizes available:

Anchor:	BM5	BM6	BM8	BM10
Thread:	M5	M6	M8	M10
Drill diameter:	13mm	13mm	19mm	19mm
Grip range:	10-92mm	10-92mm	10-64mm	10-64mm
Long strap code:	BM5L	BM6L		
Grip range:	51-240mm	51-240mm		



Also available in RoHS-compliant plating or 304 stainless steel

For Maximum Holding in:

- Cinder block
- Concrete block
- Gypsum board
- Drywall
- Plasterboard
- Composite panels
- Plaster
- Stucco
- Fiberglass
- Cement board
- Greenboard

Ideal for Mounting:

- Flat panel TVs
- DSS antennas
- Lighting fixtures
- TV mounts
- Roofs & decking
- Marine applications
- Window treatments
- Heavy machinery
- ADA hardware
- Office furniture
- Hand rails
- Grab bars
- Partitions
- Heavy fans
- Sinks
- Cabinets
- Shelving
- Solar panels
- Garage doors
- Reinstallations

SnapSkru® Self-Drilling Drywall Anchors

Fast & easy! ... Hear it "pop" & lock for extra security!

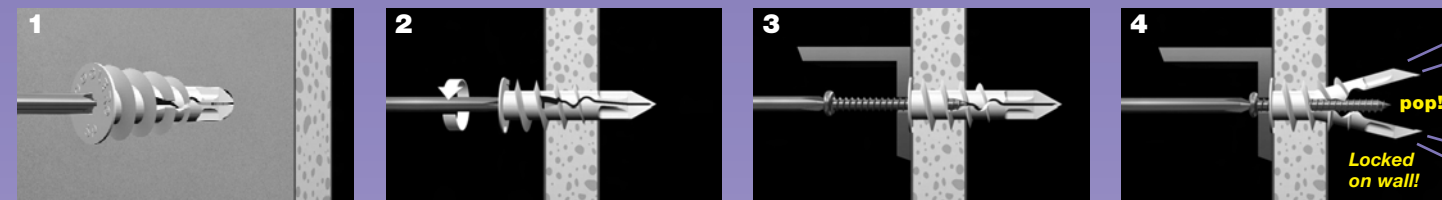

1 Press tip of SnapSkru anchor into drywall using #2 Phillips screw-driver or screw gun.

2 Drive anchor clockwise into drywall until anchor stops flush with wall.

3 Place item over anchor and insert screw.

4 Tighten screw flush with item. Screw "pops" open anchor, locking anchor on wall.

Benefits:

- **Fast & easy** to install—**NO** drill needed
- **Strongest** holding of all self-drilling drywall anchors
- Holds securely in walls & ceilings
Unique locking action **resists** shock & vibration
- Audible "**pop**" indicates correct installation
- Built-in "**positive stop**" **resists** overdrilling
- Does **not** destroy the wall—can remove screw & item, leaving anchor in wall for **reuse**
- Works with **largest** range of screw sizes:
SPM MINI = #6, #8 (#6 preferred)
SP Regular = #6, #8, #10 (#8 preferred)
- Unique tip does **not** wander on wall...drills in accurately & easily

Ultimate Load in Pounds

Anchor:	MINI		Regular	
	Tensile	Shear	Tensile	Shear
3/8" Drywall	57	57	105	108
1/2" Drywall	65	79	131	149
5/8" Drywall	95	135	175	178
Screw tested:	#6 x 1 1/4"	#8 x 1 1/2"	#6 x 1 1/4"	#8 x 1 1/2"

Specifications:

	UNC		Metric	
	MINI	Regular	MINI	Regular
Head diameter:	0.4"	0.6"	11mm	16mm
Screw sizes:	#6, #8	#6, #8, #10	Ø3.5, 4mm	Ø3.5, 4, 4.5mm
Preferred screw:	#6	#8	Ø3.5mm	Ø4mm
Screw length:	item + 1"	item + 1 1/4"	item + 25mm	item + 32mm
*Max. item thickness:	1/2"	3/4"	13mm	19mm
*with screw length:	1 1/4"	1 1/2"	32mm	38mm

* For thicker items, use longer screw

MINI SPM Anchor Benefits:

- **Stronger** than larger anchors!
- Makes only a **tiny 1/4"** hole
- **Small 0.4"** head hides behind fixture
- Head sits **flush** on wall or ceiling
- Works with both #6 & #8 screws

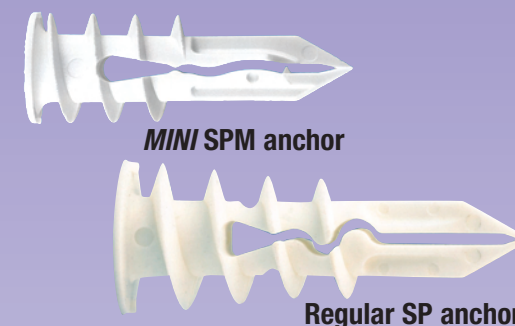

MINI SPM anchor

Regular SP anchor

For Fast, Secure Holding in:

- 3/8" through 5/8" [9.5-16mm]
- Gypsum board
- Drywall • Wallboard
- Plasterboard

Ideal for Mounting:

- Bathroom accessories
- Window treatments
- Lighting fixtures
- Smoke detectors
- CO detectors
- Picture frames
- Mirrors
- Alarms
- Shelving
- Thermostats
- Electric boxes

TOGGLER® Plastic Toggle Anchors

Easy, secure, vibration-proof anchoring for medium loads!

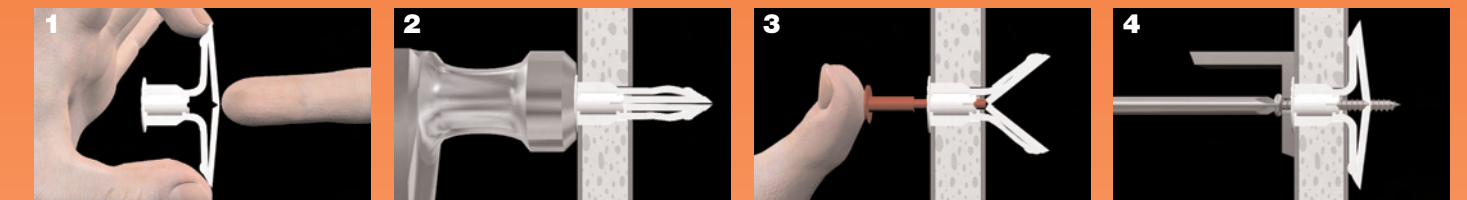

1 Drill 5/16" diameter hole (Ø8mm). Fold anchor in middle.

2 Insert anchor in hole and tap flush. Only 3/4" (19mm) clearance needed behind the wall. Only 1/2" (13mm) for the TA anchor.

3 Insert key to pop anchor open behind hollow wall (not necessary for thick or solid walls). Do **not** hammer key. Remove key.

4 Place item over anchor. Insert screw and tighten until flush with item—then stop.

Benefits:

- **Strongest** of all plastic toggle anchors
- **Vibration & shock proof**—won't damage walls or ceiling
Used to install the sprinkler system in the Tokyo subway
- Can use a screw gun—anti-rotation fins **prevent spinning**
- **Greatest** grip range for each anchor:
TA 1/8"-1/4" TC 5/8"-3/4" T35 1 3/8" [35mm]
TB 3/8"-1/2" TD 1" [26mm] T39 1 1/2" [39mm]
- **Greatest** screw range for each anchor:
#6 through #14 TA = #8 through #12
[Ø3.5-6mm dia.] [Ø4-5.5mm dia.]
- All install in only a small 5/16" hole [Ø8mm]
- Pre-install **without** the screw
- Key-activated **positive** locking system
- Corrosion-proof, nonmagnetic, nonconductive

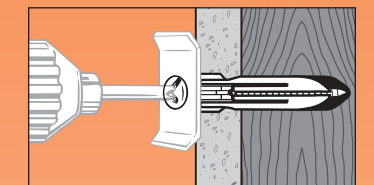

Each anchor holds securely, even if it hits an unexpected solid, like a stud or the door frame.

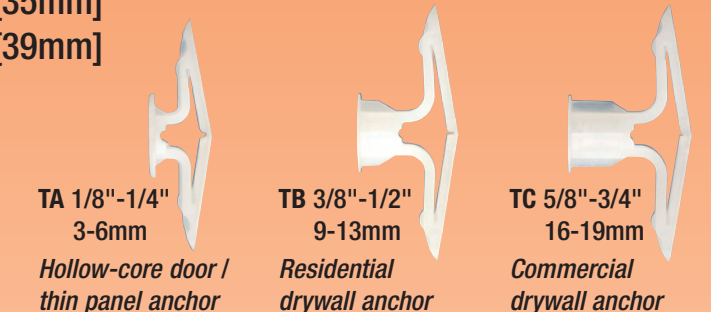

TA 1/8"-1/4" 3-6mm
Hollow-core door / thin panel anchor

TB 3/8"-1/2" 9-13mm
Residential drywall anchor

TC 5/8"-3/4" 16-19mm
Commercial drywall anchor

For Medium Holding in:

- Drywall
- Gypsum board
- Plasterboard
- Greenboard
- Fiberglass
- Hollow-core doors
- Thin paneling
- Sheet metal
- Acoustic ceilings
- Masonite® panels

Ideal for Mounting:

- Towel bars
- Window treatments
- Bath accessories
- Kitchen accessories
- Smoke detectors
- CO detectors
- Electric boxes
- Lighting fixtures
- Mirrors on hollow-core doors
- Signs
- Alarms
- Clocks
- Shelving
- Telephones
- Thermostats
- Marine hardware
- Speaker mounts

Ultimate Load in Pounds

Anchor:	TA®	TB®	TC®
	Tensile		
Plywood	1/4" 124	1/2" 175	-
3/8" Drywall	-	97	-
1/2" Drywall	-	143	-
5/8" Drywall	-	102*	159
Shear			
Plywood	1/4" 265	-	-
3/8" Drywall	-	126	-
1/2" Drywall	126*	167	-
5/8" Drywall	-	214*	237
Grip range:	1/8"-1/4"	3/8"-1/2"	5/8"-3/4"
Drill diameter:	5/16"	5/16"	5/16"
Screw tested:	#8 x 1 1/4"	#8 x 1 1/2"	#8 x 1 3/4"

* Used as wedge anchors [not toggled fully open] in walls thicker than the anchor's grip range

SNAPTOGGLE® Heavy-Duty Toggle Bolts

Like having an extra pair of hands behind the wall!

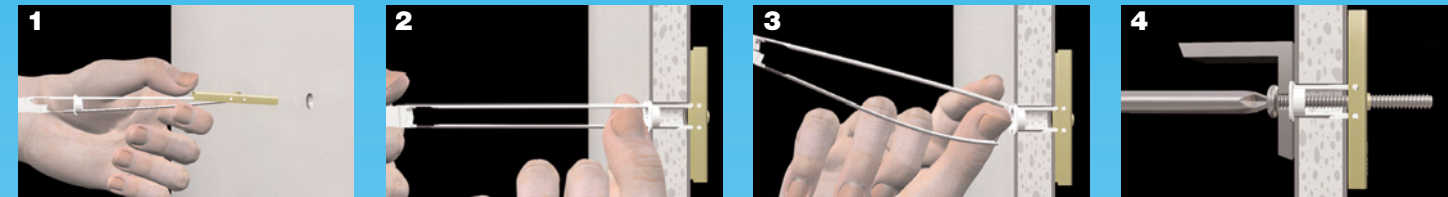

1 Drill hole. Hold metal channel flat alongside plastic straps & slide channel through the hole. Minimum clearance behind wall: only 1 7/8" (48mm).

2 Hold ends of straps together between thumb & forefinger and pull toward you until channel rests behind wall. Ratchet cap along straps with other hand until flange of cap is flush with wall.

3 Place thumb between straps at wall. Push thumb side to side, snapping off straps level with flange of cap.

4 Place item over flange. Insert bolt and tighten until snug against item, then stop. Use machine screw or bolt to match thread in metal channel.

Benefits:

- **Strong**—up to **2x the load** of an old-fashioned wing toggle
Solid metal channel resists vibration & shock
- **Save time**—at least **6 minutes** per anchor v. wing toggles
Can use a screw gun; anchor does not spin
- **Save money**—turn a 2-person job into a 1-person job
Use a shorter bolt (no need to carry a wing through the wall)
- **New strap design snaps off flush & does not break** prematurely
- **Smallest** installation hole for each bolt size
- **New golden plating is 7x more corrosion-resistant**
- **Reusable** in same hole—remove bolt without losing the anchor

Ultimate Tensile Load in Pounds

Thread:	3/16"-24	1/4"-20	5/16"-18	3/8"-16	1/2"-13
Anchor:	BA	BB	BE	BC	BD
1/2" Drywall	238	265	270	275	275
5/8" Drywall	356	356	480	576	576
Concrete block	802	1,080	1,400	1,745	2,038
Steel plate	918	1,283	1,680	1,692	2,605
Drill diameter:	1/2"	1/2"	3/4"	3/4"	3/4"
Grip range:	3/8"-3 5/8"	3/8"-3 5/8"	3/8"-2 1/2"	3/8"-2 1/2"	3/8"-2 1/2"
Long strap code:	BAL	BBL			
Grip range:	2"-9 1/2"	2"-9 1/2"			

These results are for zinc-plated steel anchors. Stainless steel channels with stainless steel bolts held greater loads in concrete & in steel plate. Long straps for roofing and for very thick walls. NOTE: 10-24 = 3/16"-24 Bolt length = item thickness + wall thickness + 1/2" (13mm).

Metric sizes available:

Anchor:	BM5	BM6	BM8	BM10
Thread:	M5	M6	M8	M10
Drill diameter:	13mm	13mm	19mm	19mm
Grip range:	10-92mm	10-92mm	10-64mm	10-64mm
Long strap code:	BM5L	BM6L		
Grip range:	51-240mm	51-240mm		



Also available in RoHS-compliant plating or 304 stainless steel

For Maximum Holding in:

- Cinder block
- Concrete block
- Gypsum board
- Drywall
- Plasterboard
- Composite panels
- Plaster
- Stucco
- Fiberglass
- Cement board
- Greenboard

Ideal for Mounting:

- Flat panel TVs
- DSS antennas
- Lighting fixtures
- TV mounts
- Roofs & decking
- Marine applications
- Window treatments
- Heavy machinery
- ADA hardware
- Office furniture
- Hand rails
- Grab bars
- Partitions
- Heavy fans
- Sinks
- Cabinets
- Shelving
- Solar panels
- Garage doors
- Reinstallations

SnapSkru® Self-Drilling Drywall Anchors

Fast & easy! ... Hear it "pop" & lock for extra security!

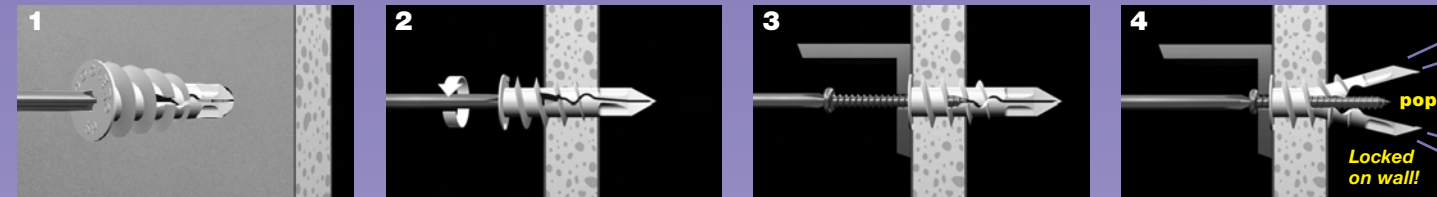

1 Press tip of SnapSkru anchor into drywall using #2 Phillips screw-driver or screw gun.

2 Drive anchor clockwise into drywall until anchor stops flush with wall.

3 Place item over anchor and insert screw.

4 Tighten screw flush with item. Screw "pops" open anchor, locking anchor on wall.

Benefits:

- **Fast & easy** to install—**NO** drill needed
- **Strongest** holding of all self-drilling drywall anchors
- Holds securely in walls & ceilings
Unique locking action **resists** shock & vibration
- Audible "**pop**" indicates correct installation
- Built-in "**positive stop**" **resists** overdrilling
- Does **not** destroy the wall—can remove screw & item, leaving anchor in wall for **reuse**
- Works with **largest** range of screw sizes:
SPM MINI = #6, #8 (#6 preferred)
SP Regular = #6, #8, #10 (#8 preferred)
- Unique tip does **not** wander on wall...drills in accurately & easily

Ultimate Load in Pounds

Anchor:	MINI	Regular	MINI	Regular
	Tensile		Shear	
3/8" Drywall	57	57	105	108
1/2" Drywall	65	79	131	149
5/8" Drywall	95	135	175	178
Screw tested:	#6 x 1 1/4"	#8 x 1 1/2"	#6 x 1 1/4"	#8 x 1 1/2"

Specifications:

	UNC		Metric	
	MINI	Regular	MINI	Regular
Head diameter:	0.4"	0.6"	11mm	16mm
Screw sizes:	#6, #8	#6, #8, #10	Ø3.5, 4mm	Ø3.5, 4, 4.5mm
Preferred screw:	#6	#8	Ø3.5mm	Ø4mm
Screw length:	item + 1"	item + 1 1/4"	item + 25mm	item + 32mm
*Max. item thickness:	1/2"	3/4"	13mm	19mm
*with screw length:	1 1/4"	1 1/2"	32mm	38mm

* For thicker items, use longer screw

MINI SPM Anchor Benefits:

- **Stronger** than larger anchors!
- Makes only a **tiny 1/4"** hole
- **Small 0.4"** head hides behind fixture
- Head sits **flush** on wall or ceiling
- Works with both #6 & #8 screws

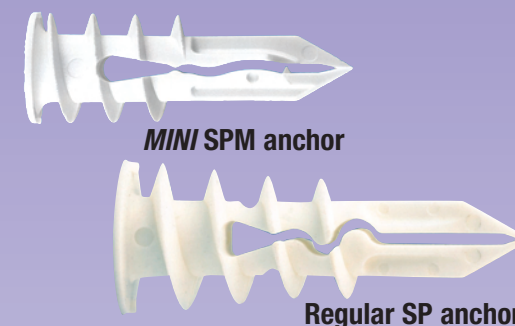

MINI SPM anchor

Regular SP anchor

For Fast, Secure Holding in:

- 3/8" through 5/8" [9.5-16mm]
- Gypsum board
- Drywall • Wallboard
- Plasterboard

Ideal for Mounting:

- Bathroom accessories
- Window treatments
- Lighting fixtures
- Smoke detectors
- CO detectors
- Picture frames
- Mirrors
- Alarms
- Shelving
- Thermostats
- Electric boxes

TOGGLER® Plastic Toggle Anchors

Easy, secure, vibration-proof anchoring for medium loads!

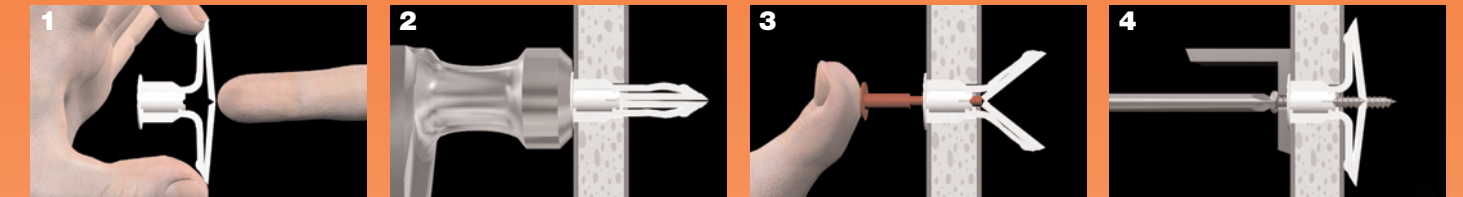

1 Drill 5/16" diameter hole (Ø8mm). Fold anchor in middle.

2 Insert anchor in hole and tap flush. Only 3/4" (19mm) clearance needed behind the wall. Only 1/2" (13mm) for the TA anchor.

3 Insert key to pop anchor open behind hollow wall (not necessary for thick or solid walls). Do **not** hammer key. Remove key.

4 Place item over anchor. Insert screw and tighten until flush with item—then stop.

Benefits:

- **Strongest** of all plastic toggle anchors
- **Vibration & shock proof**—won't damage walls or ceiling
Used to install the sprinkler system in the Tokyo subway
- Can use a screw gun—anti-rotation fins **prevent spinning**
- **Greatest** grip range for each anchor:
TA 1/8"-1/4" TC 5/8"-3/4" T35 1 3/8" [35mm]
TB 3/8"-1/2" TD 1" [26mm] T39 1 1/2" [39mm]
- **Greatest** screw range for each anchor:
#6 through #14 TA = #8 through #12
[Ø3.5-6mm dia.] [Ø4-5.5mm dia.]
- All install in only a small 5/16" hole [Ø8mm]
- Pre-install **without** the screw
- Key-activated **positive** locking system
- Corrosion-proof, nonmagnetic, nonconductive

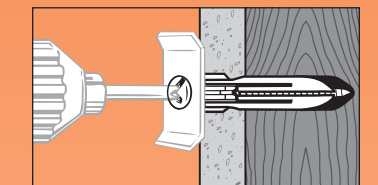

Each anchor holds securely, even if it hits an unexpected solid, like a stud or the door frame.

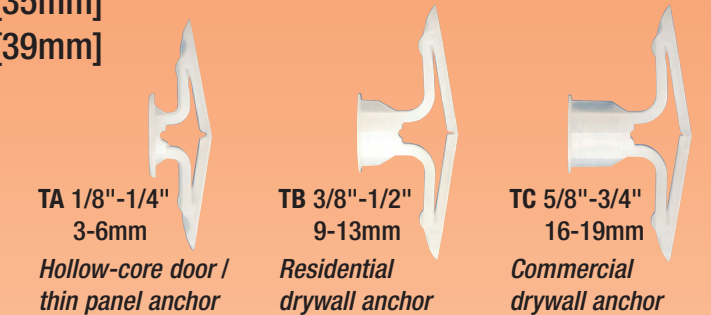

TA 1/8"-1/4" 3-6mm
Hollow-core door / thin panel anchor

TB 3/8"-1/2" 9-13mm
Residential drywall anchor

TC 5/8"-3/4" 16-19mm
Commercial drywall anchor

For Medium Holding in:

- Drywall
- Gypsum board
- Plasterboard
- Greenboard
- Fiberglass
- Hollow-core doors
- Thin paneling
- Sheet metal
- Acoustic ceilings
- Masonite® panels

Ideal for Mounting:

- Towel bars
- Window treatments
- Bath accessories
- Kitchen accessories
- Smoke detectors
- CO detectors
- Electric boxes
- Lighting fixtures
- Mirrors on hollow-core doors
- Signs
- Alarms
- Clocks
- Shelving
- Telephones
- Thermostats
- Marine hardware
- Speaker mounts

Ultimate Load in Pounds

Anchor:	TA®	TB®	TC®
	Tensile		
Plywood	1/4" 124	1/2" 175	-
3/8" Drywall	-	97	-
1/2" Drywall	-	143	-
5/8" Drywall	-	102*	159
	Shear		
Plywood	1/4" 265	-	-
3/8" Drywall	-	126	-
1/2" Drywall	126*	167	-
5/8" Drywall	-	214*	237
Grip range:	1/8"-1/4"	3/8"-1/2"	5/8"-3/4"
Drill diameter:	5/16"	5/16"	5/16"
Screw tested:	#8 x 1 1/4"	#8 x 1 1/2"	#8 x 1 3/4"

* Used as wedge anchors [not toggled fully open] in walls thicker than the anchor's grip range

SNAPTOGGLE® Heavy-Duty Toggle Bolts

Like having an extra pair of hands behind the wall!

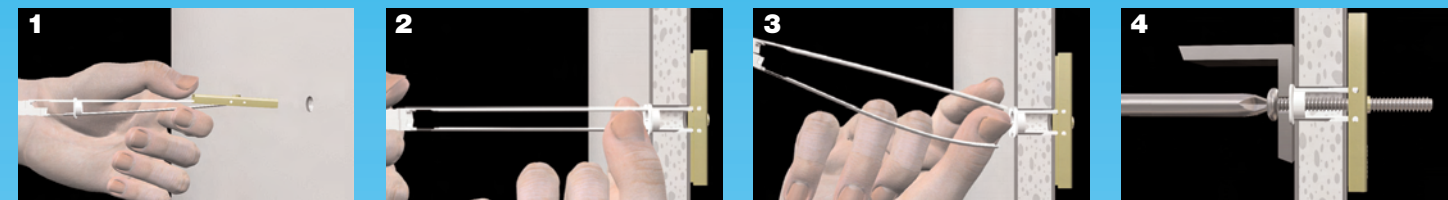

1 Drill hole. Hold metal channel flat alongside plastic straps & slide channel through the hole. Minimum clearance behind wall: only 1 7/8" (48mm).

2 Hold ends of straps together between thumb & forefinger and pull toward you until channel rests behind wall. Ratchet cap along straps with other hand until flange of cap is flush with wall.

3 Place thumb between straps at wall. Push thumb side to side, snapping off straps level with flange of cap.

4 Place item over flange. Insert bolt and tighten until snug against item, then stop. Use machine screw or bolt to match thread in metal channel.

Benefits:

- **Strong**—up to **2x the load** of an old-fashioned wing toggle
Solid metal channel resists vibration & shock
- **Save time**—at least **6 minutes** per anchor v. wing toggles
Can use a screw gun; anchor does not spin
- **Save money**—turn a 2-person job into a 1-person job
Use a shorter bolt (no need to carry a wing through the wall)
- **New strap design snaps off flush & does not break** prematurely
- **Smallest** installation hole for each bolt size
- **New golden plating is 7x more corrosion-resistant**
- **Reusable** in same hole—remove bolt without losing the anchor

Ultimate Tensile Load in Pounds

Thread:	3/16"-24	1/4"-20	5/16"-18	3/8"-16	1/2"-13
Anchor:	BA	BB	BE	BC	BD
1/2" Drywall	238	265	270	275	275
5/8" Drywall	356	356	480	576	576
Concrete block	802	1,080	1,400	1,745	2,038
Steel plate	918	1,283	1,680	1,692	2,605
Drill diameter:	1/2"	1/2"	3/4"	3/4"	3/4"
Grip range:	3/8"-3 5/8"	3/8"-3 5/8"	3/8"-2 1/2"	3/8"-2 1/2"	3/8"-2 1/2"
Long strap code:	BAL	BBL			
Grip range:	2"-9 1/2"	2"-9 1/2"			

These results are for zinc-plated steel anchors. Stainless steel channels with stainless steel bolts held greater loads in concrete & in steel plate. Long straps for roofing and for very thick walls. NOTE: 10-24 = 3/16"-24 Bolt length = item thickness + wall thickness + 1/2" (13mm).

Metric sizes available:

Anchor:	BM5	BM6	BM8	BM10
Thread:	M5	M6	M8	M10
Drill diameter:	13mm	13mm	19mm	19mm
Grip range:	10-92mm	10-92mm	10-64mm	10-64mm
Long strap code:	BM5L	BM6L		
Grip range:	51-240mm	51-240mm		



Also available in RoHS-compliant plating or 304 stainless steel

For Maximum Holding in:

- Cinder block
- Concrete block
- Gypsum board
- Drywall
- Plasterboard
- Composite panels
- Plaster
- Stucco
- Fiberglass
- Cement board
- Greenboard

Ideal for Mounting:

- Flat panel TVs
- DSS antennas
- Lighting fixtures
- TV mounts
- Roofs & decking
- Marine applications
- Window treatments
- Heavy machinery
- ADA hardware
- Office furniture
- Hand rails
- Grab bars
- Partitions
- Heavy fans
- Sinks
- Cabinets
- Shelving
- Solar panels
- Garage doors
- Reinstallations

SnapSkru® Self-Drilling Drywall Anchors

Fast & easy! ... Hear it "pop" & lock for extra security!

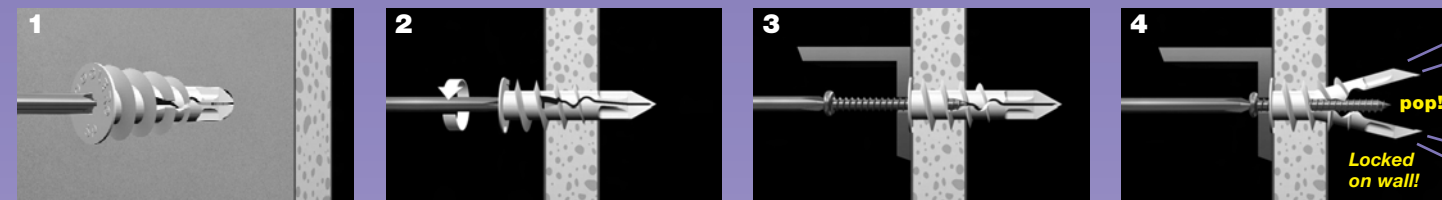

1 Press tip of SnapSkru anchor into drywall using #2 Phillips screw-driver or screw gun.

2 Drive anchor clockwise into drywall until anchor stops flush with wall.

3 Place item over anchor and insert screw.

4 Tighten screw flush with item. Screw "pops" open anchor, locking anchor on wall.

Benefits:

- **Fast & easy** to install—**NO** drill needed
- **Strongest** holding of all self-drilling drywall anchors
- Holds securely in walls & ceilings
Unique locking action **resists** shock & vibration
- Audible "**pop**" indicates correct installation
- Built-in "**positive stop**" **resists** overdrilling
- Does **not** destroy the wall—can remove screw & item, leaving anchor in wall for **reuse**
- Works with **largest** range of screw sizes:
SPM MINI = #6, #8 (#6 preferred)
SP Regular = #6, #8, #10 (#8 preferred)
- Unique tip does **not** wander on wall...drills in accurately & easily

Ultimate Load in Pounds

Anchor:	MINI		Regular	
	Tensile	Shear	Tensile	Shear
3/8" Drywall	57	57	105	108
1/2" Drywall	65	79	131	149
5/8" Drywall	95	135	175	178
Screw tested:	#6 x 1 1/4"	#8 x 1 1/2"	#6 x 1 1/4"	#8 x 1 1/2"

Specifications:

	UNC		Metric	
	MINI	Regular	MINI	Regular
Head diameter:	0.4"	0.6"	11mm	16mm
Screw sizes:	#6, #8	#6, #8, #10	Ø3.5, 4mm	Ø3.5, 4, 4.5mm
Preferred screw:	#6	#8	Ø3.5mm	Ø4mm
Screw length:	item + 1"	item + 1 1/4"	item + 25mm	item + 32mm
*Max. item thickness:	1/2"	3/4"	13mm	19mm
*with screw length:	1 1/4"	1 1/2"	32mm	38mm

* For thicker items, use longer screw

MINI SPM Anchor Benefits:

- **Stronger** than larger anchors!
- Makes only a **tiny 1/4"** hole
- **Small 0.4"** head hides behind fixture
- Head sits **flush** on wall or ceiling
- Works with both #6 & #8 screws

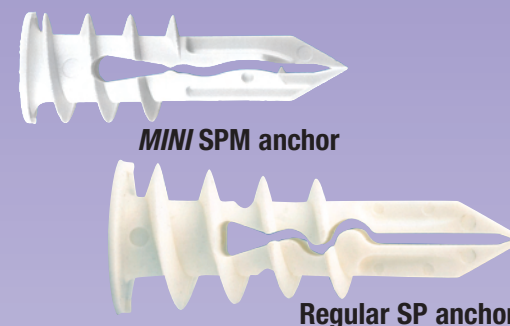

MINI SPM anchor

Regular SP anchor

For Fast, Secure Holding in:

- 3/8" through 5/8" [9.5-16mm]
- Gypsum board
- Drywall • Wallboard
- Plasterboard

Ideal for Mounting:

- Bathroom accessories
- Window treatments
- Lighting fixtures
- Smoke detectors
- CO detectors
- Picture frames
- Mirrors
- Alarms
- Shelving
- Thermostats
- Electric boxes

TOGGLER® Plastic Toggle Anchors

Easy, secure, vibration-proof anchoring for medium loads!

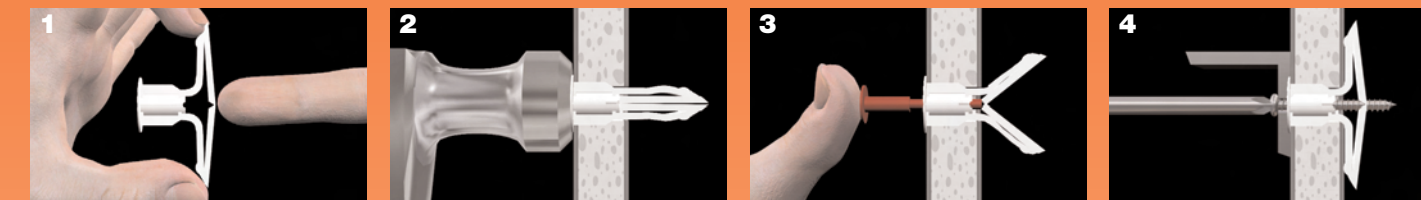

1 Drill 5/16" diameter hole (Ø8mm). Fold anchor in middle.

2 Insert anchor in hole and tap flush. Only 3/4" (19mm) clearance needed behind the wall. Only 1/2" (13mm) for the TA anchor.

3 Insert key to pop anchor open behind hollow wall (not necessary for thick or solid walls). Do **not** hammer key. Remove key.

4 Place item over anchor. Insert screw and tighten until flush with item—then stop.

Benefits:

- **Strongest** of all plastic toggle anchors
- **Vibration & shock proof**—won't damage walls or ceiling
Used to install the sprinkler system in the Tokyo subway
- Can use a screw gun—anti-rotation fins **prevent spinning**
- **Greatest** grip range for each anchor:
TA 1/8"-1/4" TC 5/8"-3/4" T35 1 3/8" [35mm]
TB 3/8"-1/2" TD 1" [26mm] T39 1 1/2" [39mm]
- **Greatest** screw range for each anchor:
#6 through #14 TA = #8 through #12
[Ø3.5-6mm dia.] [Ø4-5.5mm dia.]
- All install in only a small 5/16" hole [Ø8mm]
- Pre-install **without** the screw
- Key-activated **positive** locking system
- Corrosion-proof, nonmagnetic, nonconductive

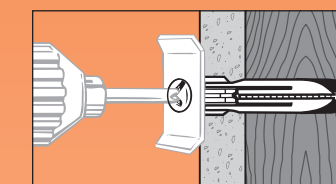

Each anchor holds securely, even if it hits an unexpected solid, like a stud or the door frame.

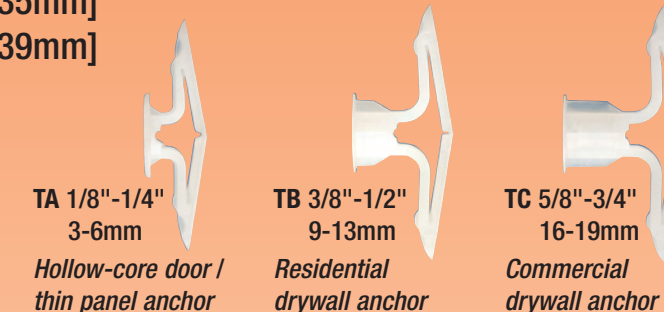

TA 1/8"-1/4" 3-6mm
Hollow-core door / thin panel anchor

TB 3/8"-1/2" 9-13mm
Residential drywall anchor

TC 5/8"-3/4" 16-19mm
Commercial drywall anchor

For Medium Holding in:

- Drywall
- Gypsum board
- Plasterboard
- Greenboard
- Fiberglass
- Hollow-core doors
- Thin paneling
- Sheet metal
- Acoustic ceilings
- Masonite® panels

Ideal for Mounting:

- Towel bars
- Window treatments
- Bath accessories
- Kitchen accessories
- Smoke detectors
- CO detectors
- Electric boxes
- Lighting fixtures
- Mirrors on hollow-core doors
- Signs
- Alarms
- Clocks
- Shelving
- Telephones
- Thermostats
- Marine hardware
- Speaker mounts

Ultimate Load in Pounds

Anchor:	TA®	TB®	TC®
	Tensile		
Plywood	1/4" 124	1/2" 175	-
3/8" Drywall	-	97	-
1/2" Drywall	-	143	-
5/8" Drywall	-	102*	159
	Shear		
Plywood	1/4" 265	-	-
3/8" Drywall	-	126	-
1/2" Drywall	126*	167	-
5/8" Drywall	-	214*	237
Grip range:	1/8"-1/4"	3/8"-1/2"	5/8"-3/4"
Drill diameter:	5/16"	5/16"	5/16"
Screw tested:	#8 x 1 1/4"	#8 x 1 1/2"	#8 x 1 3/4"

* Used as wedge anchors [not toggled fully open] in walls thicker than the anchor's grip range

ALLIGATOR® Solid-Wall Anchors

Heavy-duty anchoring in concrete & brick ... even in tile!

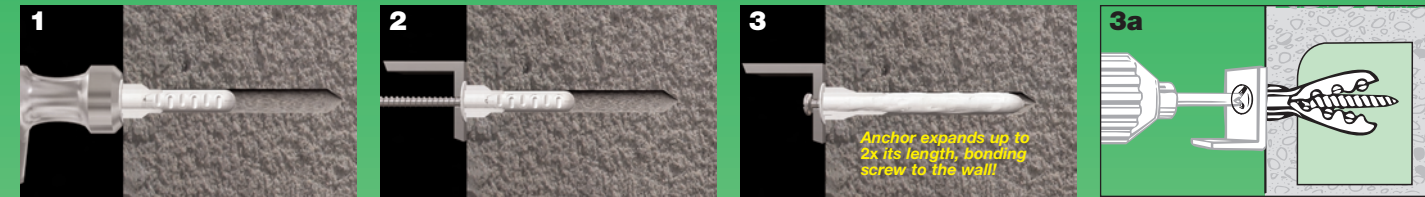

1 Drill hole same diameter as anchor. Push in anchor and tap flush.
 2 Place item over anchor, insert screw and tighten flush with item.
 3 Anti-rotation fins prevent spinning while the ALLIGATOR anchor expands along the screw in solid walls ... up to 2x its original length.
 3a In unexpected cavities or in hollow walls (hollow brick, hollow block, tile over drywall, etc.), the screw opens the anchor and its thread locks into the anchor's teeth.

Benefits:

- **Strongest**—holds up to 2x more than metal, adhesive, epoxy, and chemical anchors*
- Anchor bonds screw to concrete, brick & stone—*sealing the hole* [prevents moisture from entering hole]
- Sets instantly • Non-toxic • Rustproof • No-shelf life worry
- Resists vibration & shock in both solid & hollow walls
- Can use a screw gun—anti-rotation fins prevent spinning
- **Greatest screw range** for each anchor: [see Specifications chart below]
- **More versatile** than metal or chemical anchors—holds securely even in *hollow walls / ceilings*

* with the same screw diameter and embedment depth

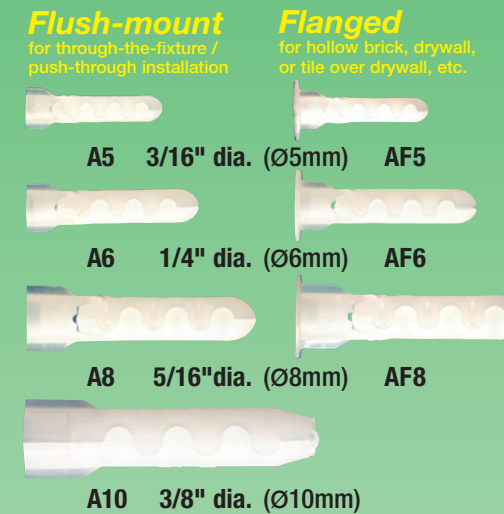

Ultimate Load in Pounds

Anchor & drill dia.:	3/16"	1/4"	5/16"	3/8"
Anchor:	A5/AF5	A6/AF6	A8/AF8	A10
Tensile				
4000 psi Concrete	2,316	2,633	3,083	4,270
1/2" Drywall	57	69	85	N/A
Shear				
1/2" Drywall	125	153	171	N/A

Specifications:

UNC				
Anchor:	A5/AF5	A6/AF6	A8/AF8	A10
Anchor & drill diameter:	3/16"	1/4"	5/16"	3/8"
Screw sizes:	#4 - #10	#6 - #14	#8 - 5/16"	#10 - 3/8"
Minimum hole depth:	1 1/2"	1 3/4"	2"	2 1/2"
Metric				
Anchor & drill diameter:	5mm	6mm	8mm	10mm
Screw sizes:	Ø3 - 5mm	Ø3.5 - 6mm	Ø4 - 8mm	Ø4.5 - 10mm
Minimum hole depth:	40mm	45mm	50mm	65mm

For Maximum Holding in:

- Concrete
- Brick
- Stone
- Masonry
- Cinder block
- Aerated concrete
- Wood
- Stucco
- Plaster
- Tile
- Drywall
- Greenboard
- RTA furniture
- Foam insulated panels

Ideal for Mounting:

- Electrical equipment
- Lighting fixtures
- Plumbing fixtures
- Partitions
- Hand rails & grab bars
- Telephone equipment
- Shelving
- Cabinets
- Awnings
- Circuit breakers
- Framing
- Alarms
- Signs
- DSS antennas
- Fire extinguishers
- Window frames
- Door jambs
- Transformers
- Storefront gates
- Smoke detectors

TOGGLER® Specialty Anchors

Simplify specialized installations!

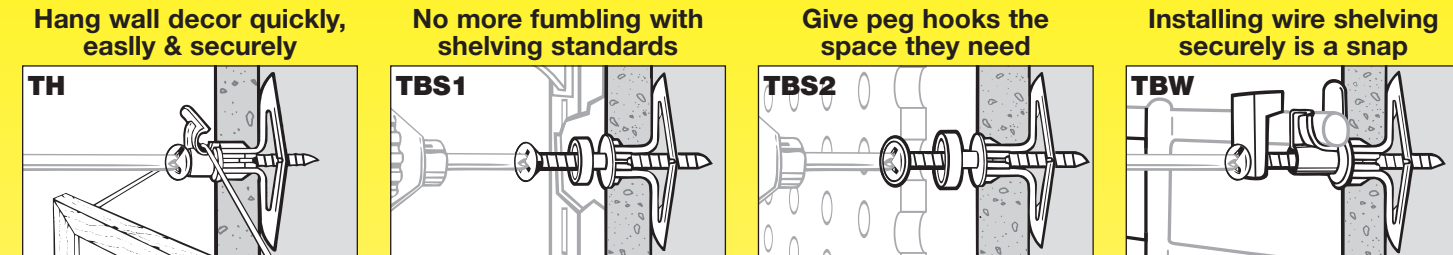

Hang wall decor quickly, easily & securely
 No more fumbling with shelving standards
 Give peg hooks the space they need
 Installing wire shelving securely is a snap

Specially designed built-in hook holds the weight of the picture on the screw—*not* below it. This provides maximum holding and prevents pull-out!
 Ideal for hanging paintings, prints, mirrors, and anything framed.

Built-in spacer prevents the anchor from being jacked out of the wall during installation.
 Also useful installing equipment on warm or wet walls when ventilation is needed behind the installed object.

Built-in spacer holds the pegboard the proper distance from the wall to allow peg hooks to work.
 This eliminates the need for furring strips, saving time & money, and allows full use of the pegboard space.

Includes a locking retainer clip so shelves don't tip, even when the load they support is distributed unevenly or near the edge. Ideal for use with systems like ClosetMaid®.
 Perfect for closet systems & kitchen, garage or workshop shelves.

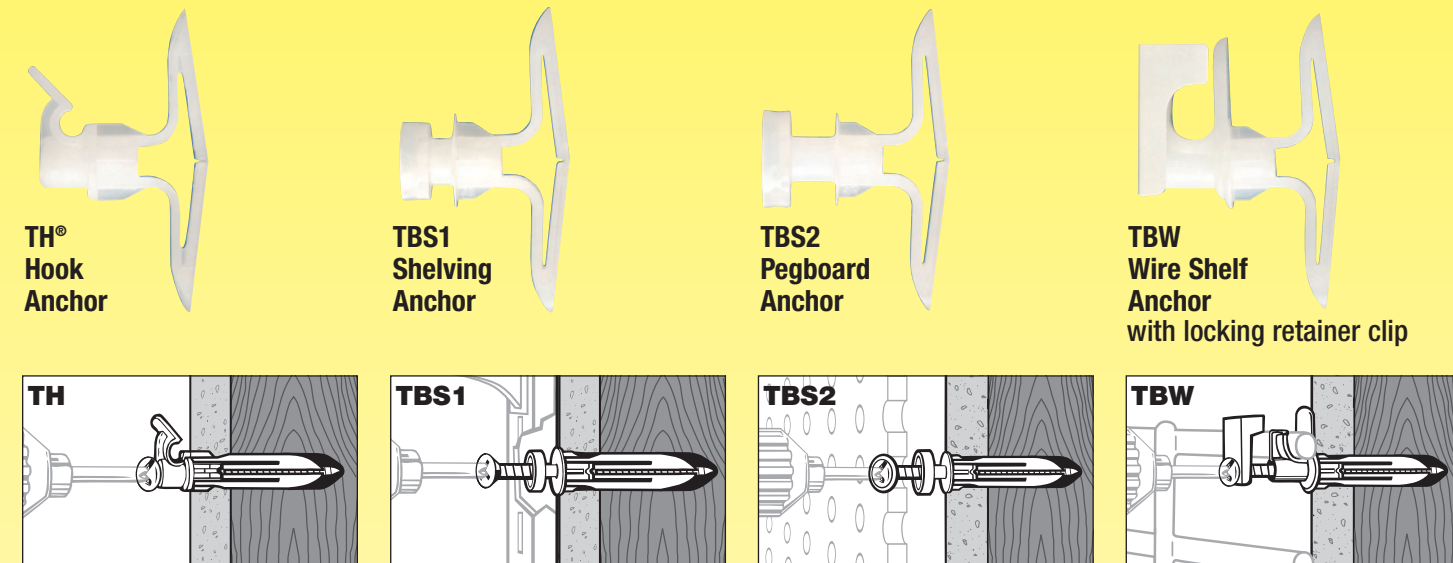

All TOGGLER specialty anchors hold securely, even if you hit a solid area, like a stud ... or in concrete, brick & stone.

Industry safety standards recommend 1/4 of ultimate test load. See MPC technical bulletins for full results of tests and for safety factors that should be applied when evaluating an application ... also for proper screw sizes and lengths.

All pull-out values are from independent laboratory tests done according to U.S. Government standards. They should be used as guides only. The age, condition, and capacity of the substrate must be considered.

Holding strength for a TOGGLER BRAND anchor varies directly with the strength of the wall material, the screw size & the extent of the screw engagement—and inversely with variations in hole diameter and the distance of the load from the wall.

ALL TOGGLER BRAND anchors are proudly made in the USA

www.togglers.com
 Installation videos & technical bulletins

Satisfaction Guaranteed

TOGGLER Anchor System is proud of its unique, patented anchors, but if they fail to perform to your satisfaction, please send the sales receipt together with any unused anchors for a full refund. Your comments would be appreciated. This guarantee is not to be construed as conferring any liability beyond the purchase price of the product.



MECHANICAL PLASTICS CORP.
 P.O. Box 554 • 444 Saw Mill River Road
 Elmsford, NY 10523 USA
 1-888-TOGGLER [1-888-864-4537]
 Fax: (914-347-3634) Tel: (914)347-2727
 Email: info@togglers.com

TOGGLER anchors are patented under one or more of U.S. Patent Nos. 4,993,901; 5,028,186; 5,161,296; 5,938,385; 6,161,999; 7,144,212; and foreign counterparts thereof and of 4,650,386; 4,673,150; 4,752,170; and 4,878,790. Other patents pending. TOGGLER and typeface, logo symbol, TA, TB, TC, TH, SNAPTOGGLE, SnapSku, and ALLIGATOR are worldwide registered trademarks of Mechanical Plastics Corp. ClosetMaid is a registered trademark of ClosetMaid, a division of Emerson™ Electric. Masonite is a registered trademark of Masonite International Corp. © 2007 Mechanical Plastics Corp. Printed in the USA 0907CAT

TOGGLER® High-Performance™ Anchors

Fast, easy & secure anchoring in ALL building materials

	Hollow Materials Drywall, Plaster, Block...	Solid Materials Concrete, Brick, Stone...	
HEAVY Duty Large TV's, Mirrors, Bookshelves, Sinks, Cabinets...	SNAPTOGGLE® Toggle Bolts 	ALLIGATOR® Solid-Wall Anchors 	HEAVY Duty Lighting fixtures, Plumbing fixtures, Partitions, Grab bars, Shelving, Cabinets...
MEDIUM Duty Bathroom accessories, Window treatments, Speaker mounts...	TOGGLER® Plastic Toggle Anchors 		to LIGHT Duty Alarms, Thermostats, Smoke detectors...
MEDIUM - LIGHT Duty Small lighting fixtures, Picture frames...	SnapSku® Regular Self-Drilling Drywall Anchors 	In All Walls ... Hollow and Solid ... Drywall to Concrete TOGGLER® Anchors for Special Projects 	
LIGHT Duty Alarms, Thermostats, Smoke detectors...	SnapSku® MINI Self-Drilling Drywall Anchors 	Picture Hook Shelving Pegboard Wire Shelf	

ALLIGATOR® Solid-Wall Anchors

Heavy-duty anchoring in concrete & brick ... even in tile!

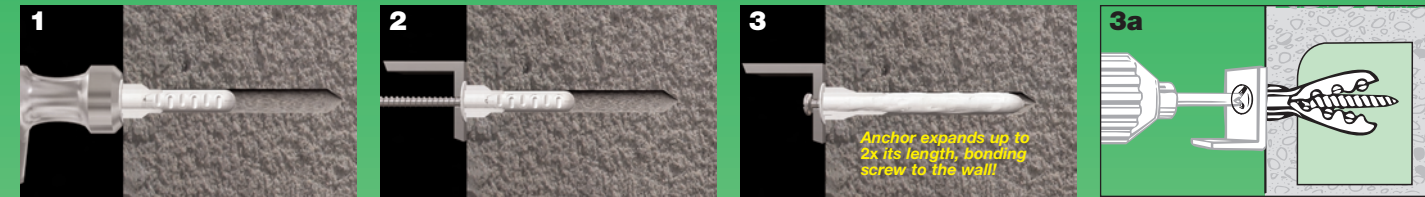

Drill hole same diameter as anchor. Push in anchor and tap flush.

Place item over anchor, insert screw and tighten flush with item.

Anti-rotation fins prevent spinning while the ALLIGATOR anchor expands along the screw in solid walls ... up to 2x its original length.

In unexpected cavities or in hollow walls (hollow brick, hollow block, tile over drywall, etc.), the screw opens the anchor and its thread locks into the anchor's teeth.

Benefits:

- **Strongest**—holds up to 2x more than metal, adhesive, epoxy, and chemical anchors*
- Anchor bonds screw to concrete, brick & stone—*sealing the hole* [prevents moisture from entering hole]
- Sets instantly • Non-toxic • Rustproof • No-shelf life worry
- Resists vibration & shock in both solid & hollow walls
- Can use a screw gun—anti-rotation fins prevent spinning
- **Greatest screw range** for each anchor: [see Specifications chart below]
- **More versatile** than metal or chemical anchors—holds securely even in *hollow walls / ceilings*

* with the same screw diameter and embedment depth

Flush-mount for through-the-fixture / push-through installation

Flanged for hollow brick, drywall, or tile over drywall, etc.

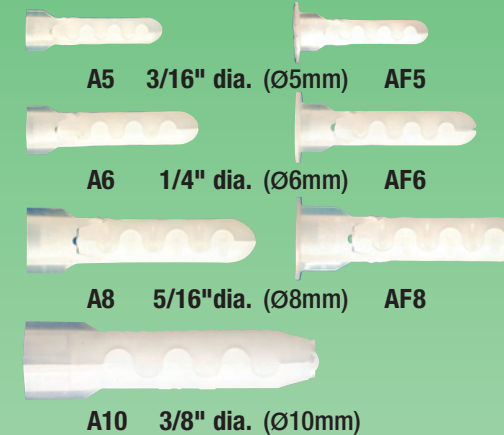

Ultimate Load in Pounds

Anchor & drill dia.:	3/16"	1/4"	5/16"	3/8"
Anchor:	A5/AF5	A6/AF6	A8/AF8	A10
Tensile				
4000 psi Concrete	2,316	2,633	3,083	4,270
1/2" Drywall	57	69	85	N/A
Shear				
1/2" Drywall	125	153	171	N/A

Specifications:

UNC				
Anchor:	A5/AF5	A6/AF6	A8/AF8	A10
Anchor & drill diameter:	3/16"	1/4"	5/16"	3/8"
Screw sizes:	#4 - #10	#6 - #14	#8 - 5/16"	#10 - 3/8"
Minimum hole depth:	1 1/2"	1 3/4"	2"	2 1/2"
Metric				
Anchor & drill diameter:	5mm	6mm	8mm	10mm
Screw sizes:	Ø3 - 5mm	Ø3.5 - 6mm	Ø4 - 8mm	Ø4.5 - 10mm
Minimum hole depth:	40mm	45mm	50mm	65mm

For Maximum Holding in:

- Concrete
- Brick
- Stone
- Masonry
- Cinder block
- Aerated concrete
- Wood
- Stucco
- Plaster
- Tile
- Drywall
- Greenboard
- RTA furniture
- Foam insulated panels

Ideal for Mounting:

- Electrical equipment
- Lighting fixtures
- Plumbing fixtures
- Partitions
- Hand rails & grab bars
- Telephone equipment
- Shelving
- Cabinets
- Awnings
- Circuit breakers
- Framing
- Alarms
- Signs
- DSS antennas
- Fire extinguishers
- Window frames
- Door jambs
- Transformers
- Storefront gates
- Smoke detectors

www.togglers.com

1-888-TOGGLER (1-888-864-4537)

TOGGLER® Specialty Anchors

Simplify specialized installations!

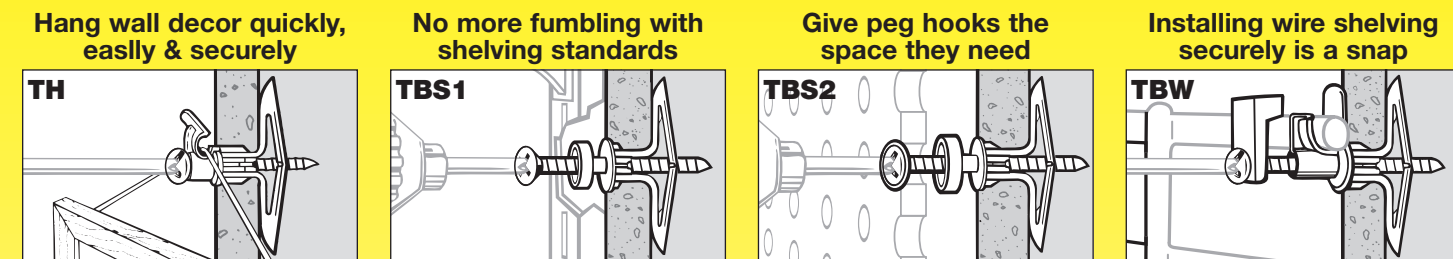

TH
Specially designed built-in hook holds the weight of the picture on the screw—*not* below it. This provides maximum holding and prevents pull-out!
Ideal for hanging paintings, prints, mirrors, and anything framed.

TBS1
Built-in spacer prevents the anchor from being jacked out of the wall during installation. Also useful installing equipment on warm or wet walls when ventilation is needed behind the installed object.

TBS2
Built-in spacer holds the pegboard the proper distance from the wall to allow peg hooks to work. This eliminates the need for furring strips, saving time & money, and allows full use of the pegboard space.

TBW
Includes a locking retainer clip so shelves don't tip, even when the load they support is distributed unevenly or near the edge. Ideal for use with systems like ClosetMaid®. Perfect for closet systems & kitchen, garage or workshop shelves.

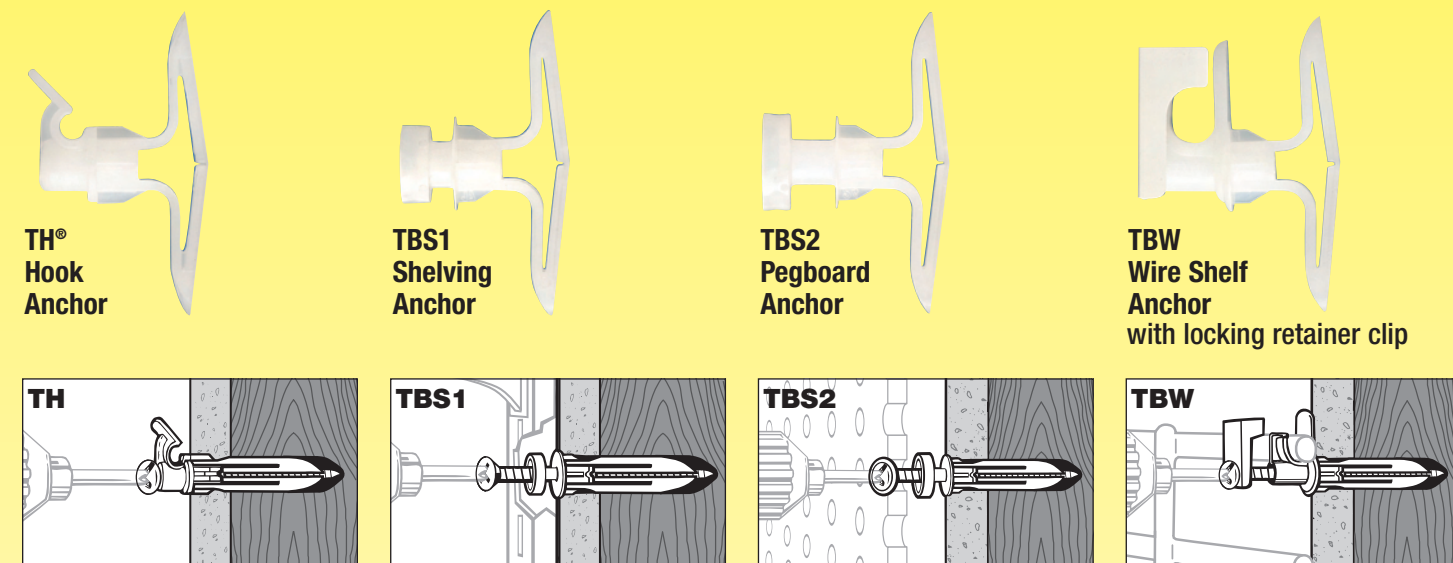

All TOGGLER specialty anchors hold securely, even if you hit a solid area, like a stud ... or in concrete, brick & stone.

Industry safety standards recommend 1/4 of ultimate test load. See MPC technical bulletins for full results of tests and for safety factors that should be applied when evaluating an application ... also for proper screw sizes and lengths.

All pull-out values are from independent laboratory tests done according to U.S. Government standards. They should be used as guides only. The age, condition, and capacity of the substrate must be considered.

Holding strength for a TOGGLER BRAND anchor varies directly with the strength of the wall material, the screw size & the extent of the screw engagement—and inversely with variations in hole diameter and the distance of the load from the wall.

ALL TOGGLER BRAND anchors are proudly made in the USA

www.togglers.com
Installation videos & technical bulletins

Satisfaction Guaranteed

TOGGLER Anchor System is proud of its unique, patented anchors, but if they fail to perform to your satisfaction, please send the sales receipt together with any unused anchors for a full refund. Your comments would be appreciated. This guarantee is not to be construed as conferring any liability beyond the purchase price of the product.



MECHANICAL PLASTICS CORP.
P.O. Box 554 • 444 Saw Mill River Road
Elmsford, NY 10523 USA
1-888-TOGGLER [1-888-864-4537]
Fax: (914-347-3634) Tel: (914)347-2727
Email: info@togglers.com

TOGGLER anchors are patented under one or more of U.S. Patent Nos. 4,993,901; 5,028,186; 5,161,296; 5,938,385; 6,161,999; 7,144,212; and foreign counterparts thereof and of 4,650,386; 4,673,150; 4,752,170; and 4,878,790. Other patents pending. TOGGLER and typeface, logo symbol, TA, TB, TC, TH, SNAPTOGGLE, SnapSku, and ALLIGATOR are worldwide registered trademarks of Mechanical Plastics Corp. ClosetMaid is a registered trademark of ClosetMaid, a division of Emerson™ Electric. Masonite is a registered trademark of Masonite International Corp. © 2007 Mechanical Plastics Corp. Printed in the USA 0907CAT

www.togglers.com

1-888-TOGGLER (1-888-864-4537)

TOGGLER® High-Performance™ Anchors

Fast, easy & secure anchoring in ALL building materials

	Hollow Materials Drywall, Plaster, Block...	Solid Materials Concrete, Brick, Stone...	
HEAVY Duty Large TV's, Mirrors, Bookshelves, Sinks, Cabinets...	SNAPTOGGLE® Toggle Bolts 	ALLIGATOR® Solid-Wall Anchors 	HEAVY Duty Lighting fixtures, Plumbing fixtures, Partitions, Grab bars, Shelving, Cabinets...
MEDIUM Duty Bathroom accessories, Window treatments, Speaker mounts...	TOGGLER® Plastic Toggle Anchors 		to LIGHT Duty Alarms, Thermostats, Smoke detectors...
MEDIUM - LIGHT Duty Small lighting fixtures, Picture frames...	SnapSku® Regular Self-Drilling Drywall Anchors 	In All Walls ... Hollow and Solid ... Drywall to Concrete TOGGLER® Anchors for Special Projects 	
LIGHT Duty Alarms, Thermostats, Smoke detectors...	SnapSku® MINI Self-Drilling Drywall Anchors 	Picture Hook Shelving Pegboard Wire Shelf	

www.togglers.com

1-888-TOGGLER (1-888-864-4537)

X-ON Electronics

Largest Supplier of Electrical and Electronic Components

Click to view similar products for [toggler](#) manufacturer:

Other Similar products are found below :

[TOGGLER](#)