

Over **40** Years of Innovation



1979



1980



1983



1986



1998



2009



2012



2014



2017-2018



# Main Menu

click on product links

	Studio Furniture (New Products!)	3
	Keyboard Stands	9
	Guitar Stands (New Products!)	12
	Guitar Hanger	14
	Amplifier Stands	14
	Pedalboards (New Products!)	15
	Speaker Stands	16
	Speaker Poles (New Products!)	20
	Lighting Trees (New Accessory)	21
	Microphone Stands & Booms	23
	Monitor Stands (New Product Design!)	29
	Laptop Mounts & Stands (New Products!)	31
	Instrument Cases & Bags	34
	Table Covers	37





Over 40 Years of Innovation



## Professional Studio Furniture NEW!

[click on product links](#)

### [Nucleus Series P. 4-6](#)

NUC-001  
NUC-002  
NUC-003  
NUC-004  
NUC-005

### [Nucleus Series Modular Parts P. 6-7](#)

NUC-TR2  
NUC-KB1  
NUC-R04  
NUC-EX24L  
NUC-EX24R  
NUC-R12L  
NUC-R12R

### [Nucleus Series Desktop Device Stand P. 7](#)

MDS-100  
MDS-X Expander

### [Studio Desk Accessories P. 7](#)

Lights  
Lights  
NUC-MM1  
NUC-MM2

### [Nucleus Z Series P. 8](#)

NUC-Z-NAV

### [Nucleus Z Series Modular Parts P. 8](#)

NUC-Z-RCK  
NUC-Z-KBD  
NUC-Z-BDM



## Ultimate Studio Furniture

### Nucleus Series

#### NUC-001, item #18100

Modular Studio Desk - Base  
Model, 12" Extensions

**Specs:**

- Overall Width: 84.8"
- Overall Depth: 36"
- Overall Height: 29.5"
- Main Worksurface Depth: 24"
- Main Worksurface Height: 29.5"
- Weight: 87.5 lbs.

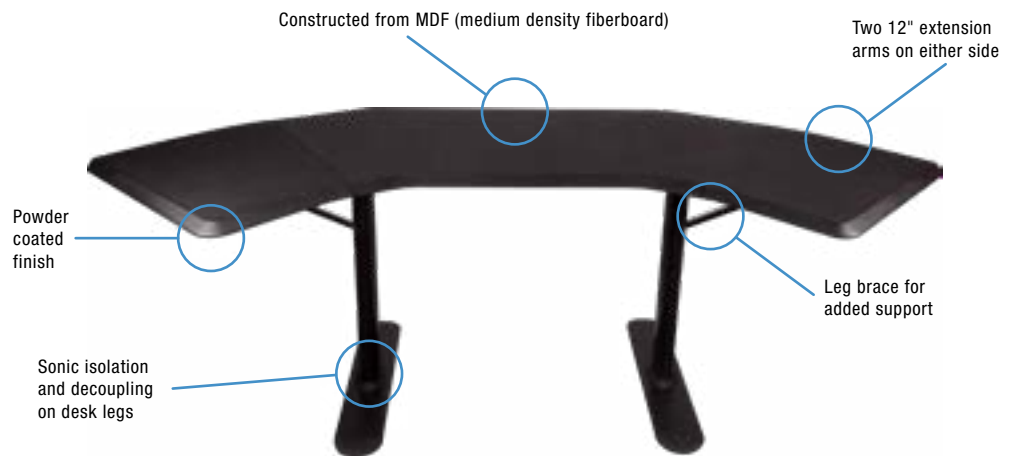

#### NUC-002, item #18101

Modular Studio Desk - Expanded  
Base Model, 12" Extensions, 2nd  
Tier, Keyboard Tray

**Specs:**

- Overall Width: 84.82"
- Overall Depth: 44"
- Overall Height: 39.29"
- Main Worksurface Depth: 24"
- Main Worksurface Height: 29.5"
- Second Tier Worksurface Depth: 12.12"
- Second Tier Worksurface Width: 58.16"
- Leveler Adjustment: .625"
- Keyboard Surface Width: 30.60"
- Keyboard Surface Depth: 9.76"
- Keyboard Surface Travel: 17.7"
- Weight: 137.5 lbs.

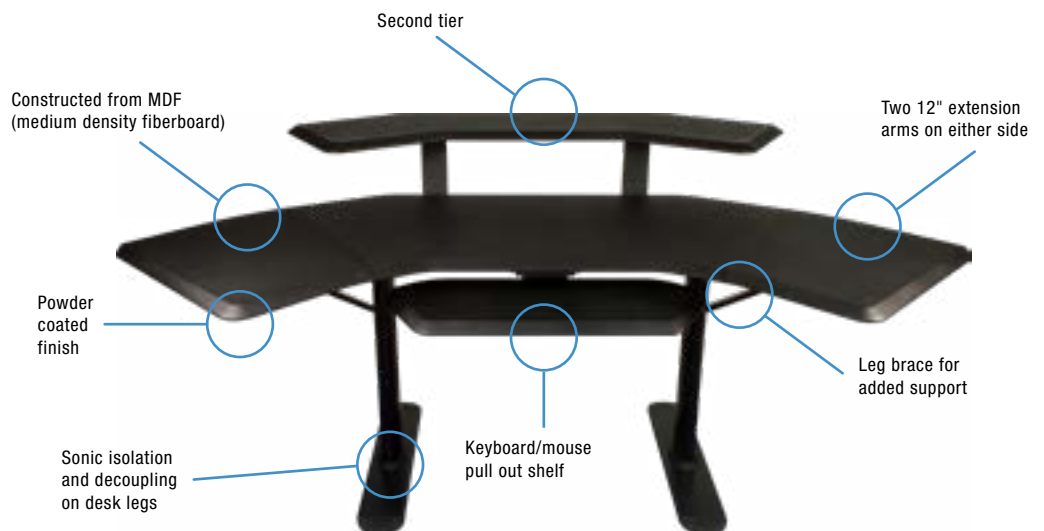



# Ultimate Studio Furniture

## Nucleus Series

### NUC-003, item #18102

Modular Studio Desk - Advanced Model, 24" Extensions, 12 Space \ Rack, 2nd Tier, Keyboard Tray

**Specs:**

- Overall Width: 101.79"
- Overall Depth: 65.3"
- Overall Height: 39.29"
- Main Worksurface Depth: 24"
- Main Worksurface Height: 29.5"
- Second Tier Worksurface Depth: 12.12"
- Second Tier Worksurface Width: 58.16"
- Leveler Adjustment: .625"
- Keyboard Surface Width: 30.60"
- Keyboard Surface Depth: 9.76"
- Keyboard Surface Travel: 17.7"
- 19" Rack Cabinets: 1
- Total Rack Cabinet Spaces: 12
- Weight: 204.75 lbs.

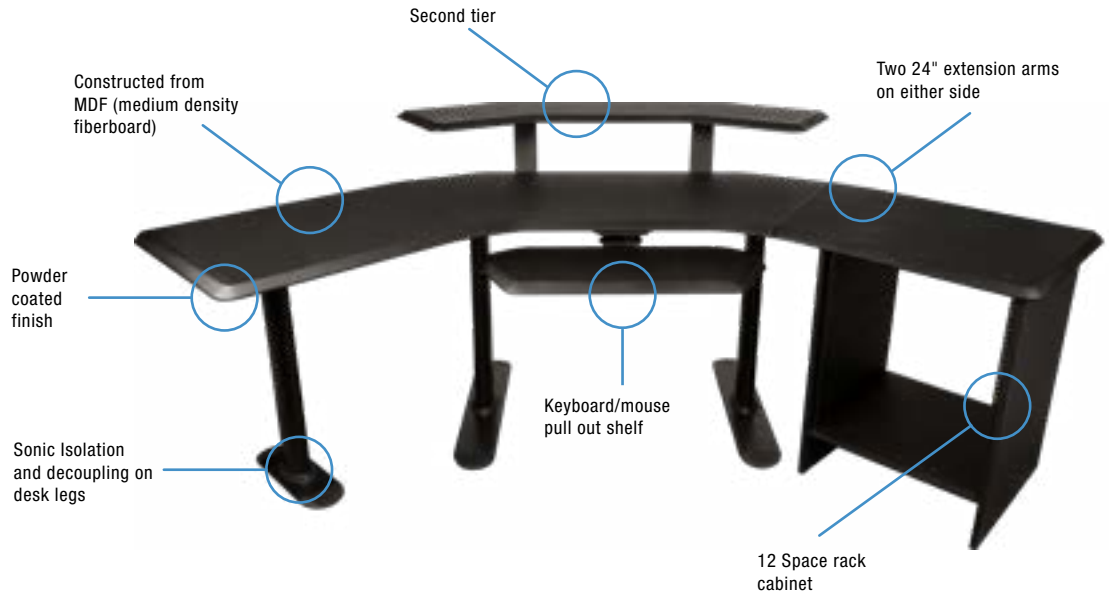

### NUC-004, item #18109

Modular Studio Desk - Advanced Model Expanded, 24" Extension, 12 Space Rack, 2nd Tier, 4 Space Rack, Keyboard Tray

**Specs:**

- Overall Width: 101.79"
- Overall Depth: 65.3"
- Overall Height: 39.29"
- Main Worksurface Depth: 24"
- Main Worksurface Height: 29.5"
- Second Tier Worksurface Depth: 12.12"
- Second Tier Worksurface Width: 58.16"
- Leveler Adjustment: .625"
- Keyboard Surface Width: 30.60"
- Keyboard Surface Depth: 9.76"
- Keyboard Surface Travel: 17.7"
- 19" Rack Cabinets: 2
- Total Rack Cabinet Spaces: 16
- Weight: 219.75 lbs.

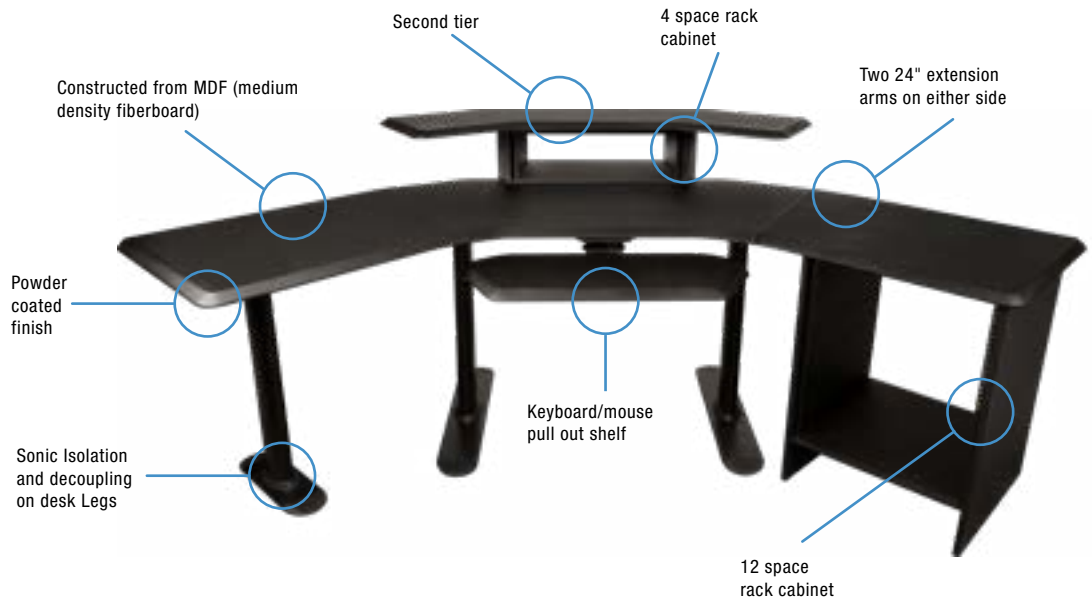



# Ultimate Studio Furniture

## Nucleus Series

**NEW!**

### NUC-005, item #18117

Modular Studio Desk - Advanced Model Expanded, 24" Extension, two 6 RU Desk Mounted Bays, 2nd Tier, 4 Space Rack, Keyboard Tray

**Specs:**

- Overall Width: 101.79"
- Overall Depth: 65.3"
- Overall Height: 39.29"
- Main Worksurface Depth: 24"
- Main Worksurface Height: 29.5"
- Second Tier Worksurface Depth: 12.12"
- Second Tier Worksurface Width: 58.16"
- Leveler Adjustment: .625"
- Keyboard Surface Width: 30.60"
- Keyboard Surface Depth: 9.76"
- Keyboard Surface Travel: 17.7"
- 19" Rack Cabinets: 3
- Total Rack Cabinet Spaces: 16
- Weight: 198.26lbs. (89.93 kg)

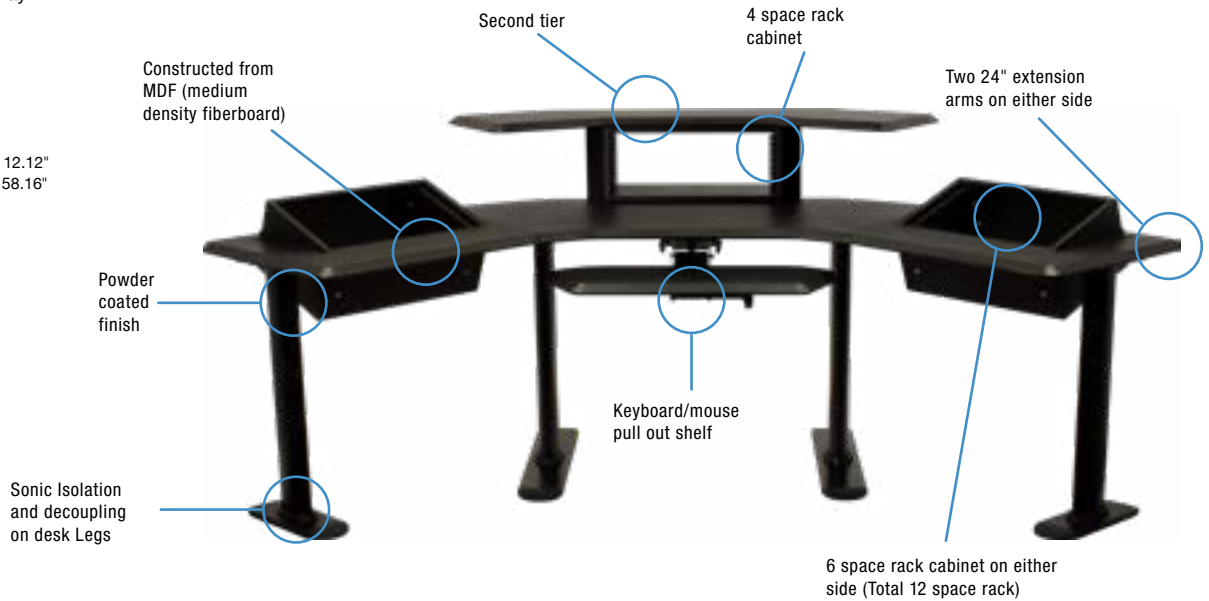

## Nucleus Series Modular Parts

### NUC-TR2, item #18106

Nucleus Series 2nd Tier

**Specs:**

- Width: 58.25"
- Height: 4"
- Depth: 18.39"
- Weight: 24 lbs.



### NUC-KB1, item #18105

Nucleus Series Keyboard Tray

**Specs:**

- Width: 30.79"
- Height: 5"
- Depth: 9.76"
- Keyboard Travel: 17.7"
- Weight: 12.55 lbs.



### NUC-R04, item #18103

Nucleus Series - Studio Desk - 4 Space Rack (Works with 2<sup>nd</sup> Tier)

**Specs:**

- Width: 20.65"
- Height: 8.75"
- Depth: 12"
- Weight: 13 lbs.





Ultimate Studio Furniture

Nucleus Series Modular Parts



NUC-EX24L, item #18112

NUC-EX24R, item #18111

Nucleus Series - Studio Desk  
Table Top - Single 24" Extension  
with Leg

**Specs:**

- Width: 32.73"
- Height: 29.5"
- Depth: 24"
- Weight: 24.68 lbs.



NUC-R12L, item #18110

NUC-R12R, item #18104

Nucleus Series - Studio Desk  
Table Top - Single 24" Extension  
with 12 Space Rack

**Specs:**

- Width: 32.73"
- Height: 29.5"
- Depth: 24"
- Weight: 55 lbs.



NUC-R6L, item #18118

NUC-R6R, item #18119

Nucleus Series - Studio Desk  
Table Top - Single 24" Extension  
with 6 RU Desk Mounted Bays

**Specs:**

- Width: 32.73"
- Height: 29.5"
- Depth: 24"
- Weight: 29.1lbs (13.2 kg) lbs.



Desktop Device Stand



MDS Accessory

MDS-100  
item #17983

Desktop Device Stand for Tabletop Synthesizers,  
Drum Machines, Effects Pedals, and Other Devices

**Specs:**

- Width - 18.83" (478.40mm)
- Depth - 7.82" (198.62mm)
- Height - 5.55" (140.94mm)
- Clamping Surface Depth - 8.34" (211.9mm)
- Clamping Surface Max Area - 133.27 sq. in. (85980.47 sq. mm)
- Clamping Width Range (w/o divider) - 6.41" (162.9mm) - 15.98" (405.9mm)
- Clamping Width Range (with divider, each side) - 2.84" (72.1mm) - 7.62" (193.59mm)
- Clamp Height - .91" (23mm)
- Weight - 2.8lbs. (1.3 kg)

Removable Center  
Dividing Wall  
for side by side  
devices.



Adjustable side  
walls can retract  
and expand.



Optional  
expander allows  
one to stack two  
MDS-100 Stands  
on top of each other.



MDS-100  
Stands Not  
Included

MDS-X Expander  
item #17984

Expander Kit for Desktop Device Stand  
(Need Two MDS-100 to Configure)

**Specs:**

- Height - 12.26" (311.34mm)
- Depth - 13.91" (353.29mm)
- Width - 18.83" (478.40mm)
- Expander Weight: 0.6lbs. (.27 kg)
- Assembled Weight: 6.2lbs. (2.8 kg)

Studio Desk Accessories

NUC-MM1, item# 18107

The Flexible and Sturdy Monitor Mount (Single)



NUC-MM2, item# 18108

The Flexible and Sturdy Monitor Mount (Double)







## Ultimate Studio Furniture

### Nucleus Z Series

#### NUC-Z-NAV, item# 18116

Modular Studio Desk - Fully Expanded Z Desk, 8 Space Rack Cabinet, Keyboard Shelf, Desk with Two 4 Space Rack Shelf's

**Specs:**

- Overall Width: 64.50"
- Overall Depth: 28"
- Overall Height: 40.4"
- Main Worksurface Depth: 23.5"
- Keyboard Worksurface Depth: 18"
- Secondary Surface Depth: 12"
- Desk Leveler Adjustment: 1"
- Rack Cabinet Leveler Adjustment: .625"
- 19" Rack Cabinets: 3
- Total Rack Cabinet Spaces: 16
- Main Worksurface Height: 34.125"
- Weight: 136 lbs.



Constructed from  
MDF (medium  
density fiberboard)

Powder coated finish

### Nucleus Z Series Modular Parts



NUC-Z-RCK, item# 18115  
Rack Cabinet (8 space)



NUC-Z-KBD, item# 18114  
Keyboard Shelf



NUC-Z-BDM, item# 18113  
Desk with Shelf and Two (2) - 4  
Space Rack Modules



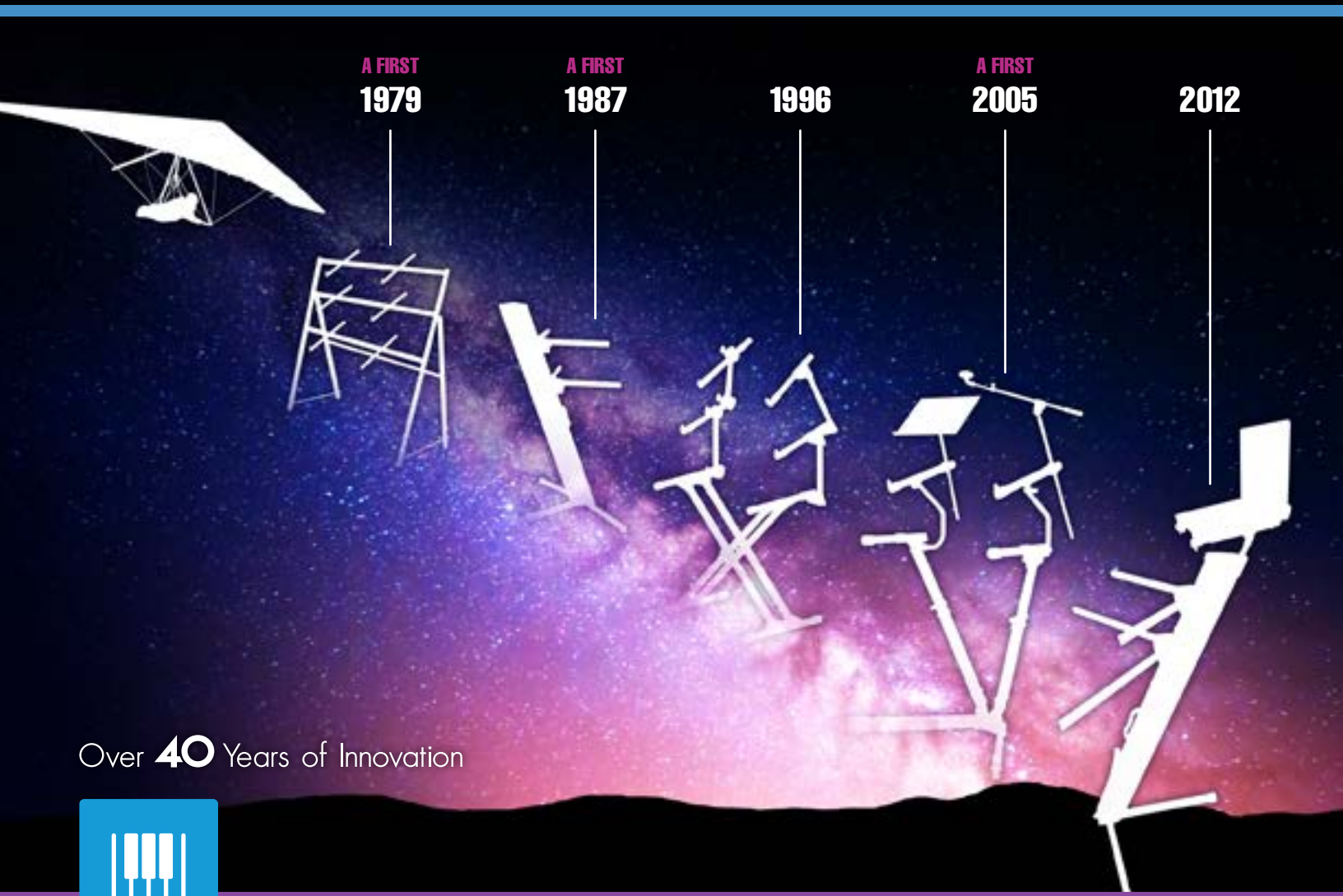

Over **40** Years of Innovation



## Professional Keyboard Stands

[click on product links](#)

### Apex® Series P. 10

- AX-48B Pro, Black
- AX-48B Pro Plus, Black
- AX-48S Pro Sliver,

### Deltex™ Series P. 10

- DX-48B Pro, Black

### V-Stand® Pro Series P. 10

- VS-88B

### IQ Series® P. 11

- IQ-3000
- IQ-2000
- IQ-1000

### Accessories P. 11

- VSIQ-200
- IQ-200
- AX-48 Pro Mic
- AX-48 Pro Bag



## Professional Keyboard Stands

### APEX® Series

#### APEX® AX-48 Pro B, item #17351

APEX® Series Professional Column Keyboard Stand with 13" and 18" Tri-bar Support Arms – Black

**Specs:**

- Height: 46" (1168mm)
- Weight: 19 lbs. (8.6 kg)
- Folded Length: 52" (1321mm)
- Load Capacity: Up to 125 lbs. per tier (56.8 kg) or 250 lbs. total (113.6 kg)

New top cap w/ professional piano-style hinge.



Height-adjustable arms hold up to 125 lbs. each.



Cable management system.



Arms and legs store inside column.

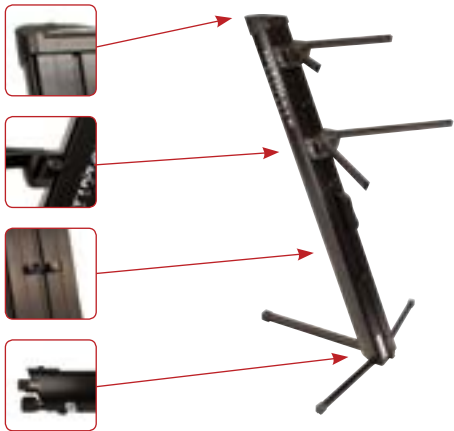

#### APEX® AX-48 Pro S, item #17476

APEX® Series Professional Column Keyboard Stand with 13" and 18" Tri-bar Support Arms – Silver

**Specs:**

- Height: 46" (1168mm)
- Weight: 19 lbs. (8.6 kg)
- Folded Length: 52" (1321mm)
- Load Capacity: Up to 125 lbs. per tier (56.8 kg) or 250 lbs. total (113.6 kg)



#### APEX® AX-48 PRO Plus, item 17368

APEX® Column Keyboard Stand Bundle with Microphone Boom and Tote Bag – Black

**Included with This Bundle:**

- AX-48 Pro Column Keyboard Stand (Black)
- Ulti-Boom Telescoping Mic Boom Arm
- AX-48 Pro Boom Adapter
- AX-48 Pro Tote Bag



**BAG & BOOM INCLUDED!**

### Deltex™ Pro Series

#### Deltex™ DX-48 Pro B, item #17908

Deltex™ Series Professional Compact Column Keyboard Stand with 13" Tri-bar Support Arms – Black

**Specs:**

- Standing Height: 45.5" (1156mm)
- Weight: 14 lbs. (6.4 kg)
- Folded Length: 49.5" (1257mm)
- Load Capacity: 75 lbs. (34 kg)

Integrated mic mount holds booms and accessories.



Stand holds up to 75 lbs.



Bag holds the support arms and foot bar.



**BAG INCLUDED!**

### V-Stand® Pro Series

#### V-Stand® Pro, Item #17479

Professional V-Style Height-adjustable Keyboard Stand

**V-Stand Pro Features:**

- Extraordinarily Versatile – Use in sitting or standing position!
- Incredibly Portable – Folds up into a compact 19" x 9.5" x 6" space!
- Heavy Load Capacity – Great for workstations, large mixers, heavy piano slabs, and DJ equipment!

Heavy-walled support arms.



Height-adjustable legs for sitting or standing.



Floor supports lock in position.



Ultra compact when folded



**BAG INCLUDED!**



## Professional Keyboard Stands

### IQ Series®

#### IQ-3000, item #14036

IQ Series® X-style Keyboard Stand with Patented Memory Lock, Nine Height Settings, Stabilizing End Caps, and Extra-strength Tubing - 300 lbs. Capacity

**Specs:**

- Height: 28.75" - 37" (730mm - 940mm)
- Width: 22" - 34" (559mm - 864mm)
- Weight: 22 lbs. (10 kg)
- Load Capacity: 300 lbs. (136.1 kg) distributed

300 lbs. weight capacity for workstations, DJ gear, mixers, etc.



Patented Memory Lock system with nine height positions.



Stabilizing end caps overcome uneven surfaces.



#### IQ-2000, item #13241

IQ Series® X-style Keyboard Stand with Patented Memory Lock, Five Height Settings, Stabilizing End Caps, and Double-braced Tubing - 150 lbs. Capacity

**Specs:**

- Height: 26.5" - 36" (673mm - 914mm)
- Width: 18.5" - 33" (469mm - 838mm)
- Weight: 15 lbs. (6.8 kg)
- Load Capacity: 150 lbs. (68.2 kg) distributed

Unprecedented strength in a lightweight design.



Patented Memory Lock system with five height positions.

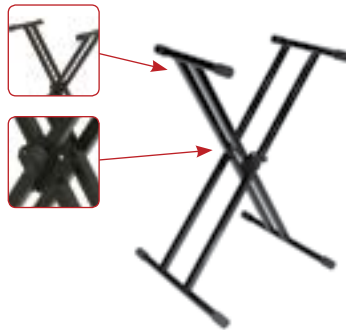

#### IQ-1000, item #13231

IQ Series® X-style Keyboard Stand with Patented Memory Lock System, Five Height Settings, Stabilizing End Caps, and Single-braced Tubing - 100 lbs. Capacity

**Specs:**

- Height: 26.5" - 36" (673mm - 914mm)
- Width: 18.5" - 33" (469mm - 838mm)
- Weight: 11 lbs. (5 kg)
- Load Capacity: 100 lbs. (45.5 kg) distributed

Patented Memory Lock system with five height positions.



Extra knee and foot room built into every IQ-1000!

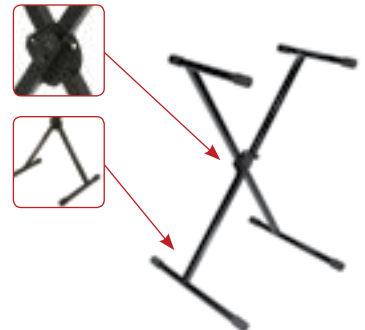

## Keyboard Stand Accessories



#### AX-48 Pro Bag, item #17367

Tote Bag for Use with AX-48 Pro Keyboard Stand



SEE  
PAGE 30

#### HYM-1000R, item # 17511

Dynamic laptop stand that mounts to an Apex or deltex keyboard Stand (Keyboard stand needs a 5/8 threaded adapter)



#### AX-48 Pro Mic, item #17366

Microphone Boom Arm Adapter and Ulti-Boom for Use with AX-48 Pro Keyboard Stand



Add to your VS-88B or IQ-3000. ▲

#### VSIQ -200B, item #17909

Professional Second Tier for V-Stand® Pro and IQ-3000 Keyboard Stands

- Load capacity: 50 lbs. (23 kg)



Add to your IQ-1000 or IQ-2000. ▲

#### IQ-200, item #13360

Second Tier for Ultimate Support IQ-2000 and IQ-1000 Keyboard Stands

- Load capacity: 50 lbs. (23 kg)

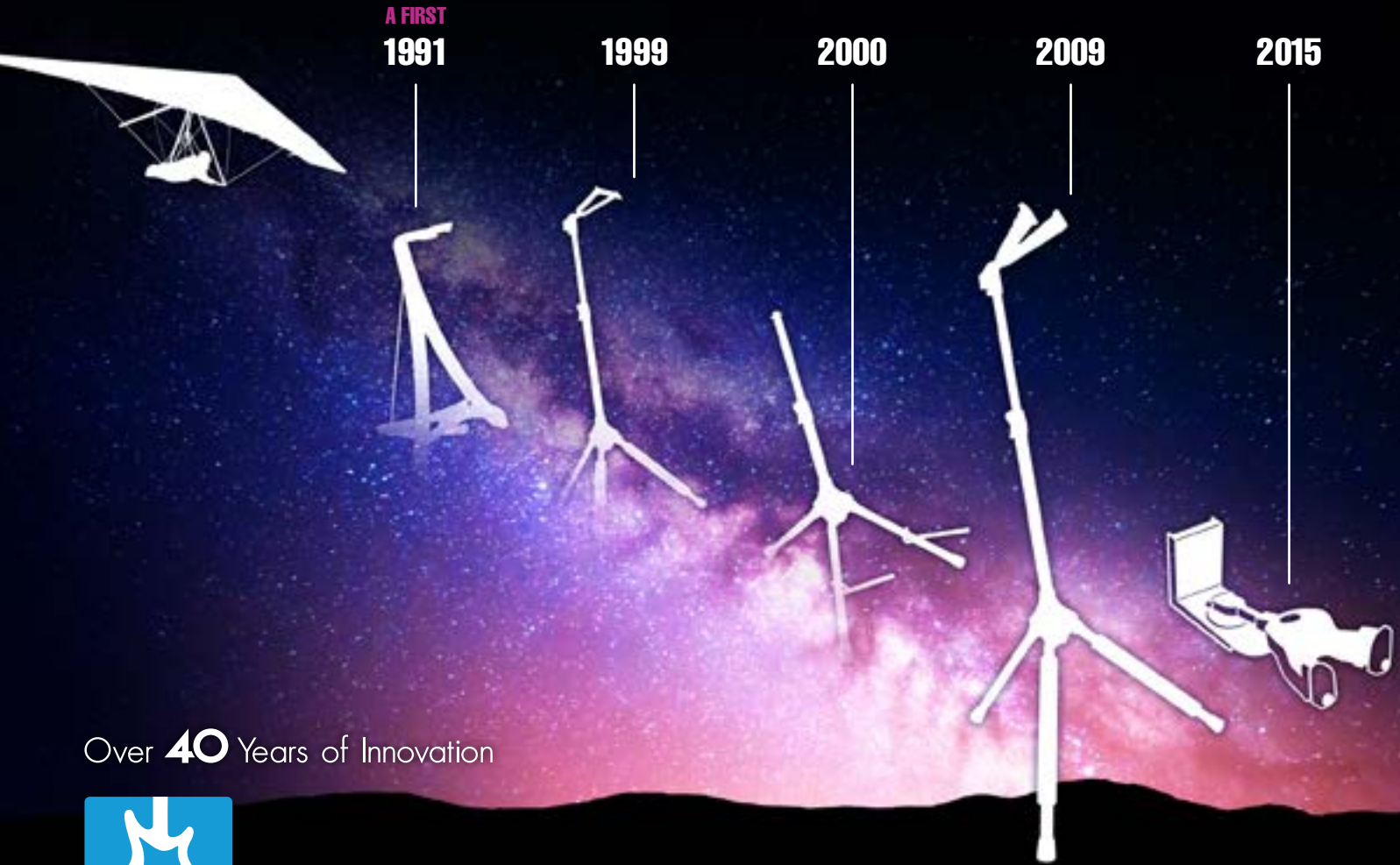

Over 40 Years of Innovation



## Genesis® Series Professional Guitar Stands, Pedalboard AMP Stand & Guitar Hanger

[click on product links](#)

### Guitar Stands P. 13-14

GS-102  
GS-1000 Pro  
GS-100  
GS-200  
GS-55

### Amp Stand P. 14

AMP-150

### Guitar Hanger P. 14

GS-10 Pro

### Pedalboard P. 15

GSP-300-BK  
GSP-500-BK  
GSP-700-BK  
GSP-500-HDC





Genesis® Series Professional Guitar Stands

Guitar Stands

**NEW!**

**GS-102, item #17602**

Height-adjustable Genesis® Series Double Guitar Stand with Locking Legs, Hanging-style Yokes and Security Straps

- Specs:**
- Security Gate: Safety Strap
  - Fixed Cradle Height: 33.7" - 46.1" (856mm - 1170.9mm)
  - Adjustable Cradle Height: 32.2" - 44.5" (817.8mm - 1130.3mm)
  - Folded Size: 3.8" x 27.5" (96.52mm x 698.5mm)
  - Weight: 4.80 lbs. (2.17kg)

Hanging-style yoke and safety strap secures guitar in place.



Quickly and easily adjust height.



Protective padding that won't inherently harm your guitar.



Showing Folded

**GS-1000 Pro, item #17600**

Height-adjustable Genesis® Series Guitar Stand with Locking Legs and Self-closing Yoke Security Gate

- Specs:**
- Set Up Height: 33.5" - 45.5" (838mm - 1156mm)
  - Weight: 3.5 lbs. (1.6 kg)
  - Folded Length: 3.5" x 21" (89mm x 533mm)

Weight-sensing yoke automatically closes to securely cradle your guitar.



Quickly and easily adjust height.

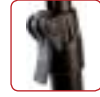

Legs lock in place when standing or folded.



Showing Folded

**GS-100, item #13710**

Height-adjustable Genesis® Series Guitar Stand with Locking Legs, Hanging-style Yoke and Security Strap

- Specs:**
- Set Up Height: 33.5" - 45.5" (838mm - 1156mm)
  - Weight: 3.5 lbs. (1.6 kg)
  - Folded Length: 3.5" x 21" (89mm x 533mm)

Hanging-style yoke and safety strap secures guitar in place.



Quickly and easily adjust height.



Protective padding that won't inherently harm your guitar.



Showing Folded

**GS-200, item #13711**

Genesis® Series Guitar Stand with Locking Legs, Secure Headstock Yoke Security Gate and Support Arms

- Specs:**
- Set Up Height: 32" (813mm)
  - Weight: 3.1 lbs. (1.4 kg)
  - Folded: 3.5" x 21" (89mm x 533mm)

Hanging-style yoke and safety strap secures guitar in place.



Support arms offer more traditional support of lower bout.



Showing Folded



Genesis® Series Professional Guitar Stand, Guitar Hanger & AMP Stand

Guitar Stand

**GS-55, item #17350**

Ultra Compact, A-Frame Style  
Genesis® Series Guitar Stand with  
Locking Legs

**Specs:**

- Set Up Height: 12.25" (311mm)
- Weight: 1.5 lbs. (.71 kg)
- Folded: 3.5" x 14" (89mm x 356mm)

Keep extra picks nearby with handy storage slots.



Stable A-Frame design holds acoustic or electric guitars.



Showing Folded

Guitar Hanger

**GS-10 PRO, item #17601**

Genesis® Series Adjustable Professional Guitar Hanger with Self-Closing Security Gates – Slatwall & Wall Mount

**Specs:**

- Wall-to-Headstock Depth: 7.75"-10.5" (196.8mm - 266.7mm)
- Adjustable Angle: Sweepable 180 Degrees
- Weight: 1 lbs. (0.5)

3" and 4" slatwall adapter. Also, Drywall adapter included.



Depth and angle adjustable



Self-closing security gates



AMP Stand

**AMP-150, item #13464**

Ultra Compact, Three-position Tilt, Genesis® Series Amp Stand with Locking Legs and Mic Boom Attachment

**Specs:**

- Set Up Height: 17.5" - 21.5" (444mm - 546mm)
- Weight: 3.1 lbs. (1.4 kg)
- Folded: 3.5" x 18" (89mm - 457mm)

Height adjustable to fit most combo amps.



Three tilt positions direct the amp's sound to your ears.



Showing Folded



**Mic Boom Not Included**  
*Never bring an extra mic stand to the gig again! Just add your boom arm and mic to the AMP-150.*





## Genesis® Series Professional Pedalboard

### Pedalboards

**NEW!**

#### GSP-300-BK, item #17843

Small Pedalboard with Cable Management System

**Specs:**

- Pedal Surface Depth: 8"
- Front Height: .94"
- Rear Height: 2.90"
- Rail Width: 1.88"
- Wire Routing Slot Width: 1.31"
- Pedal Surface Area: 161.62 sq. in.
- Weight: 3.6lbs.

**SOFT CASE INCLUDED!**



Includes a Hybrid 2.0 Bag with thick padding, water resistant outer material

Integrated cable management clips



#### GSP-500-BK, item #17841

Medium Pedalboard with Universal Power Supply Mounting System, Cable Management System, and Mic Stand Shaft Mounting Attachment

**Specs:**

- Pedal Surface Width: 24"
- Pedal Surface Depth: 14.375"
- Front Height: .938"
- Rear Height: 4.375"
- Rail Width: 1.875"
- Wire Routing Slot Width: 1.313"
- Power Supply Clamp Range: .5" - 2.5"
- Pedal Surface Area: 345 sq. in.
- Weight: 9.9lbs.

**SOFT CASE INCLUDED!**



Includes a Hybrid 2.0 Bag with thick padding, water resistant outer material and outside zipper pocket

Removable mic mount for the MC-05 mic shaft (0° or 10° tilt)



Universal power supply mounting system



Integrated cable management clips



#### GSP-700-BK, item #17845

Large Pedalboard with Two Universal Power Supply Mounting System, Cable Management System, and Mic Stand Shaft Mounting Attachment

**Specs:**

- Pedal Surface Width: 32" (812.8mm)
- Pedal Surface Depth: 17.47" (443.78mm)
- Front Height: .95" (24.23mm)
- Rear Height: 4.39" (111.53mm)
- Rail Width: 1.88" (47.75mm)
- Wire Routing Slot Width: 1.31" (33.16mm)
- Pedal Surface Area: 559.04 sq. in. (360670.25 sq. mm)
- Weight: 14.6lbs. (6.62 kg)

**HARD CASE INCLUDED!**



The GSP-700-BK ships in a flight ready style road case, that attaches to the pedalboard, allowing you to simply remove the lid and plug in during setup. Recessed latches ensure the locking mechanism doesn't get roughed up in transit.

Removable mic mount for the MC-05 mic shaft (0° or 10° tilt)



Two Universal power supply mounting system



Integrated cable management clips



### Pedalboard Accessory

#### GSP-500-HDC, item #17844

Medium Size Flight Ready Case for the GSP-500-BK

**Specs:**

- Inside Dims: 14.96" x 24.4" x 6.26" (380mm x 620mm x 159mm)
- Outside Dims: 16.5" x 26" x 7.87" (419mm x 660mm x 200mm)
- Weight: 20.15 lbs. (9.1 kg)



Includes Durable, recessed latches



Includes Road Ready Handles.



Strong construction for air travel.



Pedalboard Not Included



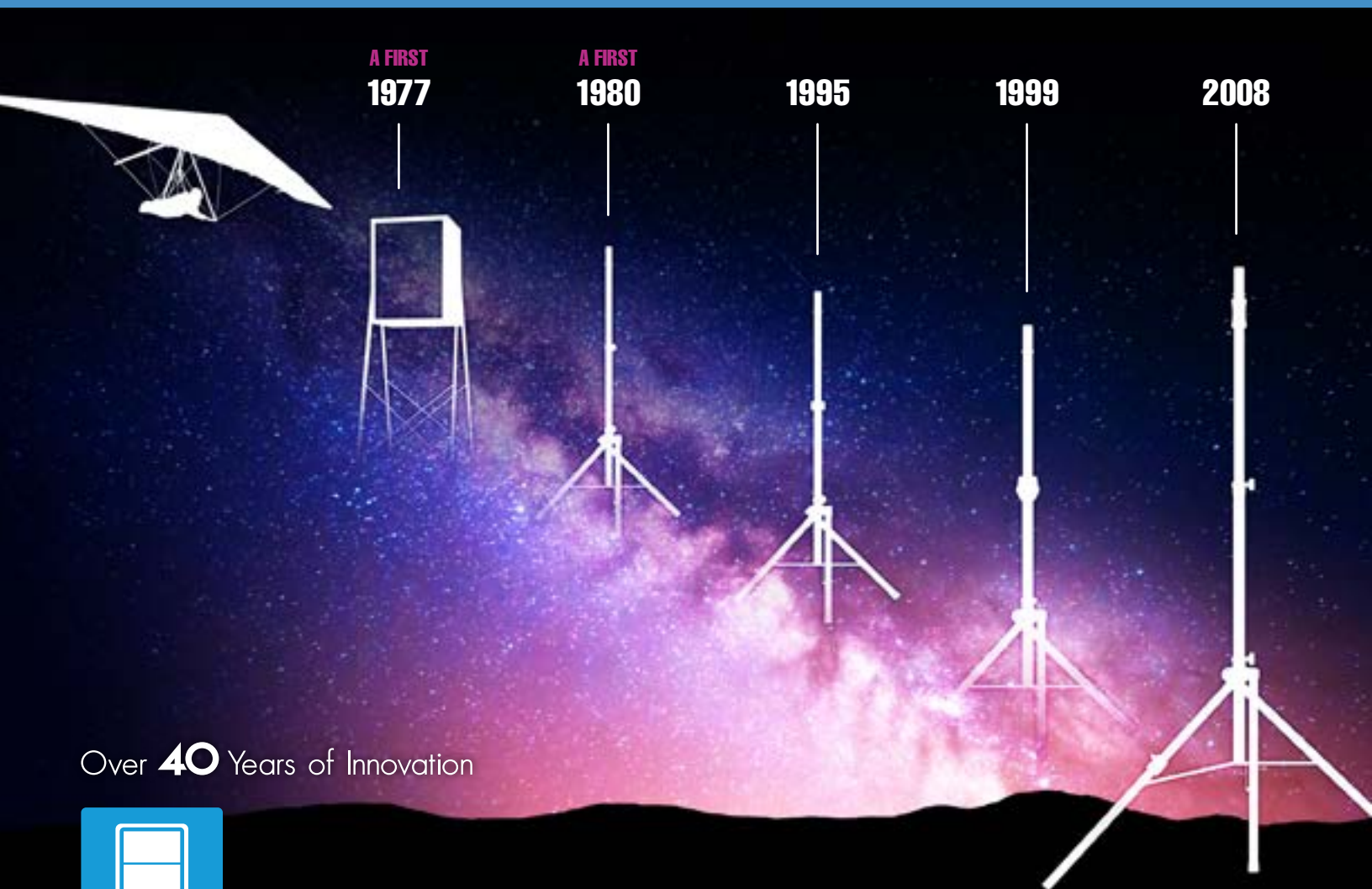

Over **40** Years of Innovation



## Professional Speaker Stands

[click on product links](#)

### [Air-Powered Series P. 17](#)

- TS-110BL
- TS-110B
- TS-100B

### [TeleLock® Series P. 18](#)

- TS-99BL
- TS-99B
- TS-90B

### [Original Series P. 19](#)

- TS-88B
- TS-80B
- TS-80S

### [Classic Series P. 19](#)

- TS-70B

### [Speaker Poles P. 20](#)

- SP-80
- SP-90
- SP-100

### [Accessories P. 20](#)

- Bag-90
- Bag-90D
- Bag-99
- Bag-99D
- BMB-200K
- TSM-150MK
- TSM-138MK
- Speaker Stand Covers





Professional Speaker Stands

Air-Powered Series



Air-Powered Series speaker stands from Ultimate Support represent everything all other speaker stands aspire to be. They're incredibly strong, extraordinarily sturdy, lightweight, and raise and lower speakers on their own! Driven by innovation and years of research and development, the Air-Powered Series features an internal shock that lifts speakers weighing 35 lbs and less with no effort, and requires very little end-user effort to raise speakers weighing more than 35 lbs!

**TS-100B, item #16759**

Air-Powered Series Lift-assist Aluminum Tripod Speaker Stand with Integrated Speaker Adapter.

**Specs:**

- Height: 3'8" - 6'7" (1118mm - 2007mm)
- Weight: 12.1 lbs. (5.5 kg)
- Base Diameter: 47" (1194mm)
- Telescoping Tube Diameter: 1.5" (38mm)
- Adapter Diameter: 1.375" (35mm)
- Load Capacity: 150 lbs. (68.2 kg)
- Folded: 43.5" x 5.5" (1105mm x 140mm)

**TS-110B, item #17356**

Air-Powered Series Lift-assist Aluminum Tripod Speaker Stand with Integrated Speaker Adapter - Extra Tall Height

**Specs:**

- Height: 5'2" - 9'2" (1575mm - 2794mm)
- Weight: 13.1 lbs. (5.5 kg)
- Base Diameter: 62" (1575mm)
- Telescoping Tube Diameter: 1.5" (38mm)
- Adapter Diameter: 1.375" (35mm)
- Load Capacity: 150 lbs. (68.2 kg)
- Folded: 57.5" x 5.5" (1461mm x 140mm)

**TS-110BL, item #17357**

Air-Powered Series Lift-assist Aluminum Tripod Speaker Stand with Integrated Speaker Adapter - Extra Tall Height and Leveling Leg

**Specs:**

- Height: 5'2" - 9'2" (1575mm - 2794mm)
- Weight: 13.5 lbs. (5.5 kg)
- Base Diameter: 62" (1575mm)
- Telescoping Tube Diameter: 1.5" (38mm)
- Leveling Leg Length: 40" - 53" (1016mm - 1346mm)
- Adapter Diameter: 1.375" (35mm)
- Load Capacity: 150 lbs. (68.2 kg)
- Folded: 57.5" x 6" (1461mm x 152mm)

Oversized, heavy wall aluminum tubing for strength and portability.

Internal air-powered shock gently raises and lowers the speaker for you.

Patented tripod design and glass-reinforced fittings and collars for gig-worthy strength.





Professional Speaker Stands

TeleLock® Series



TeleLock® Series speaker stands are some of the easiest speaker stands to use thanks to the patented TeleLock® collar. Set the TeleLock® collar to the “Raise” setting and the Auto-lock technology provides just the right amount of resistance to lock the telescoping pole in place while you adjust the height of your speaker. Set it to the “Lower” setting and gently guide your speaker down. Set it to the “Lock” setting and the speaker will securely lock in place. Owning and using TeleLock® speaker stands is like having tour support built into every show!

**TS-90B, item #13908**

TeleLock® Series Lift-assist Aluminum Speaker Stand with Integrated Speaker Adapter

**Specs:**

- Height: 3'8" - 6'7" (1118mm - 2007mm)
- Weight: 7.3 lbs. (3.3 kg)
- Base Diameter: 47" (1194mm)
- Telescoping Tube Diameter: 1.5" (38mm)
- Adapter Diameter: 1.375" (35mm)
- Load Capacity: 150 lbs. (68.2 kg)
- Folded: 43.5" x 5.5" (1105mm x 140mm)

**TS-99B, item #13910**

TeleLock® Series Lift-assist Aluminum Speaker Stand with Integrated Speaker Adapter - Extra Tall Height

**Specs:**

- Height: 5'2" - 9'2" (1575mm - 2794mm)
- Weight: 9.8 lbs. (4.5 kg)
- Base Diameter: 62" (1575mm)
- Telescoping Tube Diameter: 1.5" (38mm)
- Adapter Diameter: 1.375" (35mm)
- Load Capacity: 150 lbs. (68.2 kg)
- Folded: 57.5" x 5.5" (1461mm x 140mm)

**TS-99BL, item #13642**

TeleLock® Series Lift-assist Aluminum Speaker Stand with Integrated Speaker Adapter - Extra Tall Height and Leveling Leg

**Specs:**

- Height: 5'2" - 9'2" (1575mm - 2794mm)
- Weight: 10.2 lbs. (4.5 kg)
- Base Diameter: 62" (1575mm)
- Telescoping Tube Diameter: 1.5" (38mm)
- Leveling-leg length 40" - 53" (1016mm - 1346mm)
- Adapter Diameter: 1.375" (35mm)
- Load Capacity: 150 lbs. (68.2 kg)
- Folded: 57.5" x 6" (1461mm x 152mm)

Oversized, heavy wall aluminum tubing for strength and portability.

Patented lift-assist TeleLock® collar.

Quick Release design enables a much faster setup and tear down.

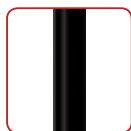

Extra tall version extends to 9' 2"!!

Extra tall version extends to 9' 2"!!

Leveling leg for placement on uneven surfaces, risers, or stairs.



# Professional Speaker Stands

## Original Series



TS-80 tripod speaker stands from Ultimate Support are the industry standard stands you've seen on stages for decades. They're sturdy and lightweight, 100% field serviceable, and are used in more venues, on more stages, and in more shows than any other speaker stand in history. Ultimate Support invented the tripod speaker stand over 30 years ago and the TS-80B, TS-80S, and TS-88B continue the legacy of quality, innovation, and strength today.

### TS-80B, item #13904

Original Series Aluminum Tripod Speaker Stand with Integrated Speaker Adapter - Black

**Specs:**

- Color: Black
- Height: 3'8" - 6'7" (1118mm - 2007mm)
- Weight: 7.3 lbs. (3.3 kg)
- Base Diameter: 47" (1194mm)
- Telescoping Tube Diameter: 1.5" (38mm)
- Adapter Diameter: 1.375" (35mm)
- Load Capacity: 150 lbs. (68.2 kg)
- Folded: 43.5" x 5.5" (1105mm x 140mm)

### TS-80S, item #13903

Original Series Aluminum Tripod Speaker Stand with Integrated Speaker Adapter - Silver

**Specs:**

- Color: Silver
- Height: 3'8" - 6'7" (1118mm - 2007mm)
- Weight: 7.3 lbs. (3.3 kg)
- Base Diameter: 47" (1194mm)
- Telescoping Tube Diameter: 1.5" (38mm)
- Adapter Diameter: 1.375" (35mm)
- Load Capacity: 150 lbs. (68.2 kg)
- Folded: 43.5" x 5.5" (1105mm x 140mm)

### TS-88B, item #13906

Original Series Aluminum Tripod Speaker Stand with Integrated Speaker Adapter - Extra Tall Height, Black

**Specs:**

- Color: Black
- Height: 5'2" - 9'2" (1575mm - 2794mm)
- Weight: 9.8 lbs. (4.5 kg)
- Base Diameter: 62" (1575mm)
- Telescoping Tube Diameter: 1.5" (38mm)
- Adapter Diameter: 1.375" (35mm)
- Load Capacity: 150 lbs. (68.2 kg)
- Folded: 57.5" x 5.5" (1461mm x 140mm)

## Classic Series

### TS-70B, item #13712

Aluminum Tripod Speaker Stand with Safe and Secure Locking Pin - Black

**Specs:**

- Height: 4'2" - 6'5" (1270mm - 1956mm)
- Weight: 5 lbs. (2.4 kg)
- Base Diameter: 40" (1016mm)
- Telescoping Tube Diameter: 1.375" (35mm)
- Adapter Diameter: 1.5" (38mm)
- Load Capacity: 150 lbs. (68.2 kg)
- Folded: 41.5" x 5" (1054mm x 127mm)

Oversized, heavy wall aluminum tubing for strength and portability.



Patented die-cast metal collar on tripod leg fitting.



Patented tripod design and glass-reinforced fittings and collars for gig-worthy strength.



TS-80B

TS-80S

TS-88B

Extra tall version extends to 9' 2"!

Light weight, super strong aluminum tubing.



Safe, secure fittings and pin mechanism.



Glass-reinforced polycarbonate fittings and collar.





## Professional Speaker Poles & Speaker Stand Accessories

### Speaker Poles



#### SP-100, item #17654

Air-Powered Series Lift-assist Aluminum Speaker Pole with Universal Fit Adapter

**Specs:**

- Height Range: 37.9" - 59.8" (964mm - 1520mm)
- Upper Tube Size: 1.5" (38.10mm)
- Lower Tube Size: 1.75" (44.45mm)
- Weight Rating: 150 lbs. (68.2kg)
- Weight: 5.7lbs. (2.58kg)

Speaker adapter fits both 1.5" & 1.375" speaker mounts.



Air-Powered Lift speakers weighing 35-45 lbs. with ease!



Universal fit adapter & threaded connector



#### SP-90, item #17653

TeleLock® Series Lift-Assist Aluminum Speaker Pole with Universal Fit Adapter

**Specs:**

- Height Range: 36.5" - 57.2" (928mm - 1454mm)
- Upper Tube Size: 1.5" (38.10mm)
- Lower Tube Size: 1.75" (44.45mm)
- Weight Rating: 150lbs. (68.2kg)
- Weight: 3.85lbs (1.75kg)

Patented TeleLock collar holds pole in place while you set speaker height!



#### SP-80, item #17652

Original Series Aluminum Speaker Pole with Universal Fit Adapter

**Specs:**

- Height Range: 36.5" - 60" (928mm - 1520mm)
- Upper Tube Size: 1.5" (38.10mm)
- Lower Tube Size: 1.75" (44.45mm)
- Weight Rating: 150 lbs. (68.2kg)
- Weight: 3.15lbs. (1.42kg)

Patented die-cast metal collar on TLF.



### Speaker Stand Accessories

#### USDJ-PSB-S, item #17704

(Black, Standard) Pair Of Attractive Sleeves For Speaker Stand And Lighting Tree

#### USDJ-PSW-S, item #17706

(White, Standard) Pair Of Attractive Sleeves For Speaker Stands And Lighting Trees

Compatible Ultimate Speaker Stands: TS-100B, TS-90B, TS-80B, TS-80S

**BAG INCLUDED!**



#### USDJ-PSB-T, item #17705

(Black, Tall) Pair Of Attractive Sleeves For Speaker Stands And Lighting Trees

#### USDJ-PSW-T, item #17707

(White, Tall) Pair Of Attractive Sleeves For Speaker Stands And Lighting Trees

Compatible Ultimate Speaker Stands & Lighting Trees: TS-100B, TS-90B, TS-80B, TS-80S, LT-99B, LT-99BL, LT-88B

**BAG INCLUDED!**



#### Bag-90, item #15691

Speaker Stand Tote for One Regular Sized Speaker Stand



#### Bag-90D, item #15693

Speaker Stand Tote for Two Regular Sized Speaker Stands



#### Bag-99, item #15692

Speaker Stand Tote for One Extra Tall Speaker Stand



#### Bag-99D, item #15694

Speaker Stand Tote for Two Extra Tall Speaker Stand



#### BMB-200K, item #10766

External Speaker Cabinet Mounting Bracket for Mounting Speaker Cabinets on Speaker Stands



#### TSM-150MK, item #13421

Internal Mounting Bracket for Mounting Speaker Cabinets on Speaker Stands - 1-1/2"



#### TSM-138MK, item #13425

Internal Mounting Bracket for Mounting Speaker Cabinets on Speaker Stands - 1-3/8"





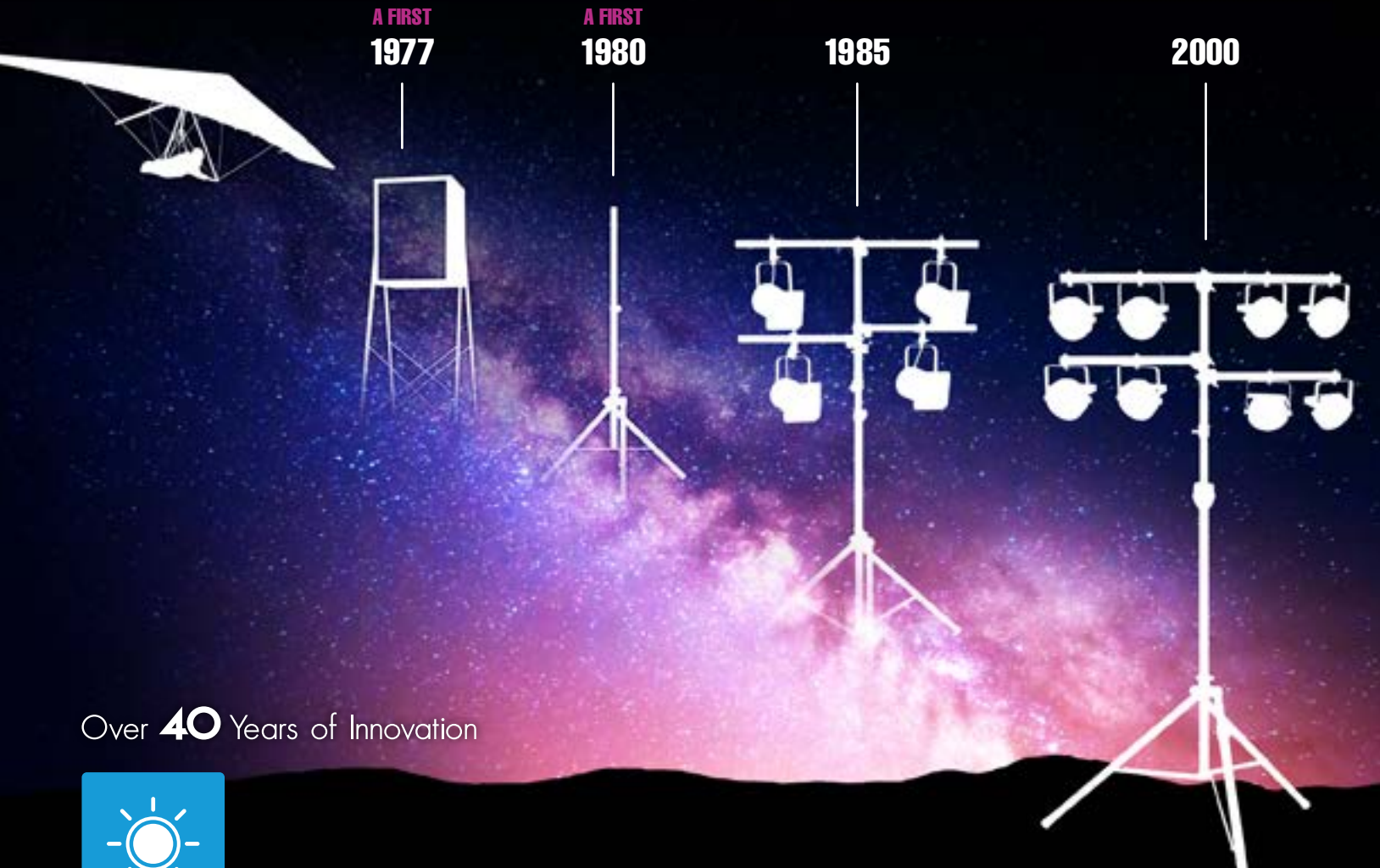

**A FIRST**  
**1977**

**A FIRST**  
**1980**

**1985**

**2000**

Over **40** Years of Innovation



## Professional Lighting Trees

[click on product links](#)

### Lighting Trees P. 22

LT-99BL

LT-99B

LT-88B

### Accessories P. 22

LTB-48B

LTB-24B

LTV-24B

LT-48FP Fly Point Lighting Bar

Speaker Stand Covers



# Professional Lighting Trees

## TeleLock®

### LT-99B, item #17347

LT Series Multi-tiered, Heavy-duty, Extra Tall Lighting Tree & TeleLock® Lift-assist Technology

- Specs:**
- Included Components:
    - TS-99B Aluminum Tripod Stand
    - LTV-24B 24" Vertical Extension
    - LTB-48B 48" T-style Lighting Crossbar
    - LTB-24B 24" Lighting Sidebars (Qty: 2)
  - Base Diameter: 62" (1575mm)
  - Height: 7' 2" to 11' 2" (2184mm to 3406mm)
  - Weight: 19.6 lbs. (8 kg)
  - Telescoping Tube Diameter: 1.5" (38mm)
  - Load Capacity: 150 lbs. (68.2 kg)



### LT-99BL, item #17387

LT Series Multi-tiered, Heavy-duty, Extra Tall Lighting Tree & Leveling Leg with TeleLock® Lift-assist Technology

- Specs:**
- Included Components:
    - TS-99BL Tripod Stand w/Leveling Leg
    - LTV-24B 24" Vertical Extension
    - LTB-48B 48" T-style Lighting Crossbar
    - LTB-24B 24" Lighting Sidebars (Qty: 2)
    - Bag-99D Carrying Bag
  - Base Diameter: 62" (1575mm)
  - Height: 7' 2" to 11' 2" (2184mm to 3406mm)
  - Weight: 19.6 lbs. (8 kg)
  - Telescoping Tube Diameter: 1.5" (38mm)
  - Load Capacity: 150 lbs. (68.2 kg)

**Leveling leg** for placement on uneven surfaces, risers, or stairs.



## Original

### LT-88B, item #17343

LT Series Multi-tiered, Heavy-duty, Extra Tall Lighting Tree with Patented Aluminum Tripod Stand

- Specs:**
- Included Components:
    - TS-88B Aluminum Tripod Stand
    - LTV-24B 24" Vertical Extension
    - LTB-48B 48" T-style Lighting Crossbar
    - LTB-24B 24" Lighting Sidebars (Qty: 2)
  - Base Diameter: 62" (1575mm)
  - Height: 7' 2" to 11' 2" (2184mm to 3406mm)
  - Weight: 17.6 lbs (8 kg)
  - Telescoping Tube Diameter: 1.5" (38mm)
  - Load Capacity: 150 lbs. (68.2 kg)



## Lighting Tree Accessories

**NEW!**

**LT-48FP Fly Point Lighting Bar**  
item #14109  
Speaker Lighting Bar Attachment for Two Lighting Cans



**LTV-24B, item #14108**  
24" Vertical Extension for Adding Additional Height to TS Tripod Speaker Stands

**LTB-48B, item #14107**  
T-style 48" Lighting Crossbar For Use on Ultimate Support TS Tripod Speaker Stands or LTV-24B Vertical Extension

**SEE PAGE 20**

Sleeves For Speaker Stands

**LTB-24B, item #14106**  
Two 24" Lighting Sidebars For Use on Ultimate Support TS Tripod Speaker Stands or LTV-24B Vertical Extension



**A FIRST**  
**1983**



**1991**



**2003**



**A FIRST**  
**2009**



Over **40** Years of Innovation



## Microphone Stands and Booms

[click on product links](#)

### Pro Series R P. 24

- Pro-R-T
- Pro-R-T-T
- Pro-R-T-F
- Pro-R-T-Short-T
- Pro-R-T-Short-F
- Pro-R-SB
- Pro-R-ST

### Pro Series Extreme P. 25

- Pro-X-T
- Pro-X-T-T
- Pro-X-T-F
- Pro-X-T-Short-T
- Pro-X-T-Short-F

### Full Tilt P. 26

- MC-FT-100
- MC-FT-200

### Live Retro Series P. 26

- LIVE-MC-66B
- LIVE-MC-70B
- LIVE-MC-77B

### Classic Series P. 27

- MC-40B Pro
- MC-40B Pro 3-Pack
- MC-40B Pro Short
- MC-05B

### Studio Series P. 27

- MC-125

### Mic Booms Series P. 28

- Ulti-Boom Pro-F
- Ulti-Boom Pro-T
- MC-40B Pro Boom

### QuickRelease P. 28

- QR-5
- QR-1



# Professional Microphone Stands

**NEW!**

## Pro Series R

### Pro-R-T, item #17955

Pro Series R Microphone Stand with Patented Quarter-turn Clutch - Reinforced Plastic Tripod Base/Standard Height

- Specs:**
- Tube Material: Steel
  - Tube Finish: Powder Coated
  - Tube Diameter: .87" (22 mm)
  - Base Type: Locking Tripod
  - Base Diameter: 26" (660 mm)
  - Height Type: Standard
  - Shaft Height: 37.5" - 65" (953 mm x 1651 mm)
  - Weight: 5.6 lbs (2.5 kg)

Patented Quarter-turn Clutch



Durable Light Weight Tubing



Locking Base is made of durable, lightweight, reinforced plastic.

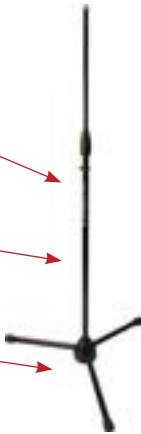

### Pro-R-T-T, item #17957

Pro Series R Microphone Stand with Patented Quarter-turn Clutch - Reinforced Plastic Tripod Base/Standard Height/Telescoping Boom

- Specs:**
- Tube Material: Steel
  - Tube Finish: Powder Coated
  - Tube Diameter: .87" (22 mm)
  - Base Type: Locking Tripod
  - Base Diameter: 26" (660 mm)
  - Height Type: Standard
  - Shaft Height: 37.5" - 65" (953 mm x 1651 mm)
  - Boom Type: Telescoping
  - Boom Length: 20" - 35" (508 mm - 889 mm)
  - Weight: 7.55 lbs (3.4 kg)

Telescoping Ultra-Boom Pro included.



### Pro-R-T-F, item #17956

Pro Series R Microphone Stand with Patented Quarter-turn Clutch - Reinforced Plastic Tripod Base/Standard Height/Fixed Boom

- Specs:**
- Tube Material: Steel
  - Tube Finish: Powder Coated
  - Tube Diameter: .87" (22 mm)
  - Base Type: Locking Tripod
  - Base Diameter: 26" (660 mm)
  - Height Type: Standard
  - Shaft Height: 37.5" - 65" (953 mm x 1651 mm)
  - Boom Type: Fixed
  - Boom Length: 31.75" (806 mm)
  - Weight: 7.55 lbs (3.4 kg)

Fixed-length Ultra-Boom Pro included.



### Pro-R-T-Short-T, item #17959 Pro-R-T-Short-F, item #17958

Pro Series R Microphone Stand with Patented Quarter-turn Clutch - Tripod Base/Short Height/Ulti-Boom Pro

- Specs:**
- Tube Material: Steel
  - Tube Finish: Powder Coated
  - Tube Diameter: .87" (22 mm)
  - Base Type: Locking Tripod
  - Base Diameter: 26" (660 mm)
  - Height Type: Short
  - Shaft Height: 19.25" - 28.25" (489 mm x 718 mm)
  - Boom Length (Telescoping): 20" - 35" (508 mm - 889 mm)
  - Boom Length (Fixed-length): 31.75" (806 mm)
  - Weight: 6.55 lbs (2.9 kg)

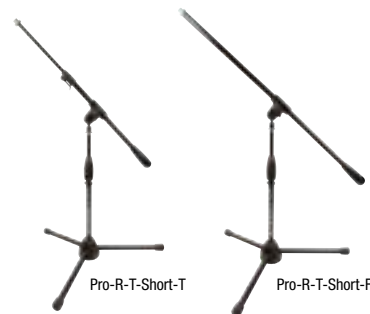

### Pro-R-SB, item #17953

Pro Series R Microphone Stand with Patented Quarter-turn Clutch - Stackable Base/Standard Height

- Specs:**
- Tube Material: Steel
  - Tube Finish: Powder Coated
  - Tube Diameter: .87" (22 mm)
  - Base Type: Weighted Round Stackable Base
  - Base Diameter: 11.25" (286 mm)
  - Height Type: Standard
  - Shaft Height: 35" - 62.5" (889 mm x 1588 mm)
  - Weight: 8.15 lbs (3.7 kg)

Stackable base allows up to six stands to stack in the foot print of one.



### Pro-R-ST, item #17954

Pro Series R Microphone Stand with Patented Quarter-turn Clutch - Standard Weighted Base/Standard Height

- Specs:**
- Tube Material: Steel
  - Tube Finish: Powder Coated
  - Tube Diameter: .87" (22 mm)
  - Base Type: Weighted Round Standard Base
  - Base Diameter: 11.25" (286 mm)
  - Height Type: Standard
  - Shaft Height: 35" - 62.5" (889 mm x 1588 mm)
  - Weight: 9.15 lbs (4.2 kg)

Round die-cast weighted base







# Professional Microphone Stands

## Pro Series Extreme

**NEW!**

### Pro-X-T, item #17882

Pro Series Extreme Microphone Stand with Patented Quarter-turn Clutch - Die Cast Aluminum Tripod Base/Standard Height

- Specs:**
- Tube Material: Steel
  - Tube Finish: Powder Coated
  - Tube Diameter: 1" (25 mm)
  - Base Type: Locking Tripod
  - Base Diameter: 26" (660 mm)
  - Height Type: Standard
  - Shaft Height: 39.25" - 68.125" (997mm - 1730.4mm)
  - Weight: 6.70 lbs (3.04 kg)

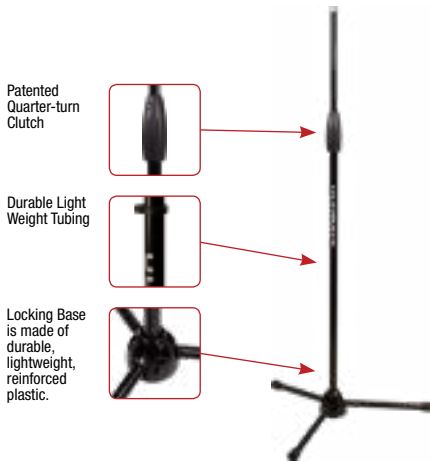

### Pro-X-T-T, item #17884

Pro Series Extreme Microphone Stand with Patented Quarter-turn Clutch - Die Cast Aluminum Tripod Base/Standard Height/Telescoping Boom

- Specs:**
- Tube Material: Steel
  - Tube Finish: Powder Coated
  - Tube Diameter: 1" (25 mm)
  - Base Type: Locking Tripod
  - Base Diameter: 26" (660 mm)
  - Height Type: Standard
  - Shaft Height: 39.25" - 68.125" (997mm - 1730.4mm)
  - Boom Type: Telescoping
  - Boom Length: 20" - 35" (508 mm - 889 mm)
  - Weight: 8.6 lbs (3.90 kg)



### Pro-X-T-F, item #17883

Pro Series Extreme Microphone Stand with Patented Quarter-turn Clutch - Die Cast Aluminum Tripod Base/Standard Height/Fixed Boom

- Specs:**
- Tube Material: Steel
  - Tube Finish: Powder Coated
  - Tube Diameter: 1" (25 mm)
  - Base Type: Locking Tripod
  - Base Diameter: 26" (660 mm)
  - Height Type: Standard
  - Shaft Height: 39.25" - 68.125" (997mm - 1730.4mm)
  - Boom Type: Fixed
  - Boom Length: 31.75" (806 mm)
  - Weight: 8.6 lbs (3.90 kg)



### Pro-X-T-Short-T, item #17886

Pro Series R Microphone Stand with Patented Quarter-turn Clutch - Tripod Base/Short Height/Ulti-Boom Pro

- Specs:**
- Tube Material: Steel
  - Tube Finish: Powder Coated
  - Tube Diameter: 1" (25 mm)
  - Base Type: Locking Tripod
  - Base Diameter: 26" (660 mm)
  - Height Type: Short
  - Shaft Height: 20.875" - 29.625" (530mm - 752.5mm)
  - Boom Length (Telescoping): 20" - 35" (508 mm - 889 mm)
  - Boom Length (Fixed-length): 31.75" (806 mm)
  - Weight: 7.25 lbs (3.29 kg)

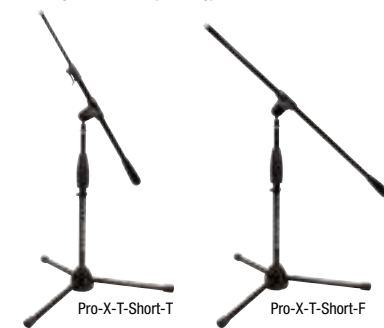

# MIC STAND COMPARISON

## What Mic Stand Fits You?

Live Retro Series	Pro Extreme Series	Pro-R Series	Classic Series
46.875" - 73.75"	39.25" - 68.125"	37.5" - 65"	36" - 63"
Height Adjustable Grip	Oversize Grip	Standard Grip	Standard Grip
Oversized Tubing Aluminum Size: 1"	Oversized Tubing Steel Size: 1"	Standard Tubing Steel Size: .87"	Standard Tubing Steel Size: .87"
Reinforced Plastic Locking Legs	Solid Metal Locking Legs	Reinforced Plastic Locking Legs	Reinforced Plastic Folding Legs



**NEW!**

# Professional Microphone Stands

## Full-Tilt

### MC-FT-200, item #17943

Full-Tilt (Adjustable) Microphone Stand with Foot Pedal Control (0° - 10° Tilt)

- Specs:**
- Base Type: Full-Tilt (Adjustable)
  - Height Type: Standard
  - Vertical Height: 35" - 62.75" (889mm x 1594mm)
  - Angled Height: 34.75" - 61.75" (883mm x 1568mm)
  - Tube Diameter: .87" (22 mm)
  - Tube Material: Steel
  - Base Diameter: 11.25" (286mm)
  - Weight: 10.5 lbs. (4.8 kg)

Durable, lightweight aluminum construction.



Locking tripod base.



### MC-FT-100, item #17913

Full-Tilt (Fixed) Microphone Stand (0° & 10° Tilt)

- Specs:**
- Base Type: Full-Tilt (Fixed)
  - Height Type: Standard
  - Vertical Height: 35" - 62.75" (889mm x 1594mm)
  - Angled Height: 34.75" - 61.75" (883mm x 1568mm)
  - Tube Diameter: .87" (22 mm)
  - Tube Material: Steel
  - Base Diameter: 11.25" (286mm)
  - Weight: 11.05 lbs. (5 kg)

Durable, lightweight aluminum construction.



Locking tripod base.



## Live Retro Series (One-Handed Clutch)

### LIVE-MC-66B, item #17962

Live Retro Series Microphone Stand with One-handed Height Adjustment, Durable Lightweight Aluminum Construction - Tripod Locking Legs

- Specs:**
- Tube Material: Aluminum
  - Tube Diameter: 1" (25mm)
  - Base Type: Locking Tripod
  - Base Diameter: 26" (660mm)
  - Height Type: Standard
  - Shaft Height: 46.875" - 73.75" (1191mm - 1873mm)
  - Weight: 4.3 lbs. (1.9 kg)

Ergonomic clutch - one-handed height adjustment.



Durable, lightweight aluminum construction.



Locking tripod base.



### Live-MC-77B, item #17960

Live Retro Series Microphone Stand with One-handed Height Adjustment, Durable Lightweight Aluminum Construction - Stackable Round Weighted Base

- Specs:**
- Tube Material: Aluminum
  - Tube Diameter: 1" (25mm)
  - Base Type: Weighted Round Stackable Base
  - Base Diameter: 26" (660mm)
  - Height Type: Standard
  - Shaft Height: 43.875" - 70.75" (1114mm - 1797mm)
  - Weight: 7.95 lbs. (3.6 kg)

Stackable base allows up to six stands to stack in the foot print of one.



### Live-MC-70B, item #17961

Live Retro Series Microphone Stand with One-handed Height Adjustment, Durable Lightweight Aluminum Construction - Standard Round Weighted Base

- Specs:**
- Tube Material: Aluminum
  - Tube Diameter: 1" (25mm)
  - Base Type: Weighted Round Standard Base
  - Base Diameter: 26" (660mm)
  - Height Type: Standard
  - Shaft Height: 43.875" - 70.75" (1114mm - 1797mm)
  - Weight: 9.10 lbs. (4.1 kg)

Stable weighted base.





# Professional Microphone Stands

## Classic Series

### MC-40B Pro, item #17950

Classic Series Tripod Microphone Stand with Three-way Adjustable Boom Arm and Stable Tripod Base

- Specs:**
- Boom length: 31.75" (806mm)
  - Height: 36" - 63" (914mm - 1600mm)
  - Tube Diameter: .875" (22mm)
  - Tube Material: Steel

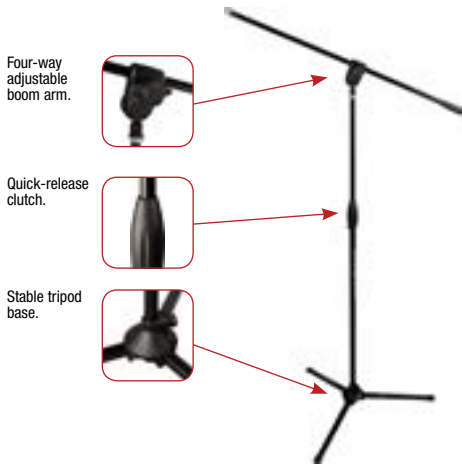

### MC-40B Pro 3-Pack, item #17951

Classic Series Tripod Microphone Stand with Three-way Adjustable Boom Arm and Stable Tripod Base — 3-Pack

- Specs:**
- Boom length: 31.75" (806mm)
  - Height: 36" - 63" (914mm - 1600mm)
  - Tube Diameter: .875" (22mm)
  - Tube Material: Steel



### MC-40B Pro Short, item #17905

Classic Series Short Tripod Microphone Stand with Three-way Adjustable Boom Arm and Stable Tripod Base

- Specs:**
- Boom length: 24" (610mm)
  - Height: 18.25" - 27.75" (464mm - 705mm)
  - Tube Diameter: .875" (22mm)
  - Tube Material: Steel

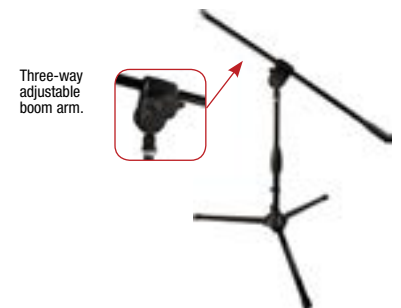

## Classic Series (Con.)

### MC-05B, item #13461

Classic Series Microphone Stand with Quick-release Clutch and Weighted Round Base

- Specs:**
- Finish: E-coated
  - Base Type: Round Weighted Base
  - Base Diameter: 10" (254mm)
  - Height Type: Standard
  - Height: 34.75" - 64" (883mm - 1626mm)
  - Tube Diameter: .87" (22mm)
  - Weight: 8.8 lbs. (4 kg)



## Studio Series

### MC-125, item #16124

Studio Boom with Adjustable Counter Weight and Rollerblade Style Caster Wheels

- Specs:**
- Finish: Powder Coated
  - Base Type: Weighted Base with Wheels
  - Base Diameter (with Casters): 26" (660mm)
  - Height: 51.5" - 82.75" (1308mm - 2102mm)
  - Tube Diameter: 1.1" (28mm)
  - Weight: 35 lbs. (15.88 kg)
  - Boom Length: 35" - 61" (889mm - 1549mm)
  - Counterweight Weight: 5.75 lbs. (2.6 kg)





# Professional Microphone Booms

## Ulti-Boom Pro Series

### Ulti-Boom Pro-TB, item #17651

Microphone Boom Arm with Patented One-touch Adjustment, StableLock Telescoping Lever, & Metal Counterweight - Telescoping

- Specs:**
- Boom Length: 20"-35" (508mm - 889mm)
  - Counterweight: .65 lbs. (0.3 kg)

Adjusts telescoping arm quickly, and doesn't allow it to slip!



### Ulti-Boom Pro-FB, item #17650

Microphone Boom Arm with Patented One-touch Adjustment & Metal Counterweight - Fixed Length

- Specs:**
- Boom Length: 34.75" (883mm)
  - Counterweight: .65 lbs. (0.3 kg)

Oversized and heavy-duty tubing.



Patented One-Touch Adjustment



Tilt



Pan



Depth



Rotate

## MC-40B Boom Series

### MC-40B Pro Boom, item #17952

Fixed Microphone Boom With Four Degrees of Freedom

- Specs:**
- Boom Length: 31.75" (806mm)

Heavy-duty counterweight.



Ulti-Boom Pro TB    Ulti-Boom Pro FB    MC-40B Pro Boom

## QuickRelease



### QR-5, item #17516

Five (5) QuickRelease Adapters for Microphone Stands and Microphone Clips & Free Carrying Case Bundle

- Five QR-1 adapters included
- Handy carrying case for FREE!
- Quickly swap mics on stands
- 2-piece QuickRelease adapter
- Made from strong steel



CASE INCLUDED!

### QR-1, item #17512

QuickRelease Adapter for Microphone Stands and Microphone Clips

- 2-piece QuickRelease Adapters
- Made from strong steel





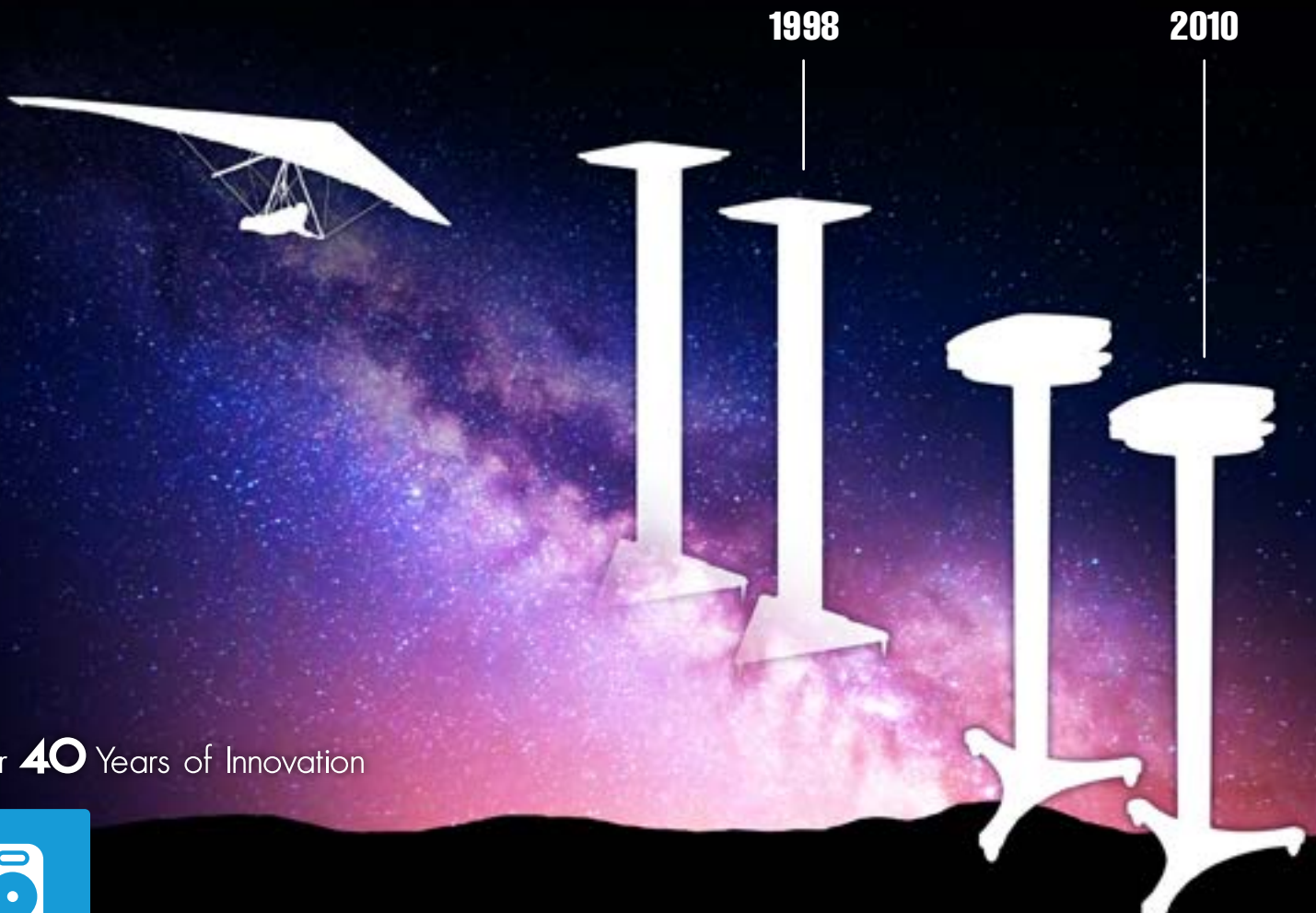

Over **40** Years of Innovation



## Professional Monitor Stands

[click on product links](#)

### Column, Angle-Adjustable P. 30

MS-100B (Black)

MS-100R (Red)

### Column, 45" Tall P. 30

MS-45B (Black)

MS-45R (Red)

### Column, 36" Tall P. 30

MS-36B (Black)

MS-36R (Red)

### Desktop, Angle-Adjustable P. 30

MS-80B (Black)



# Professional Monitor Stands

## Monitor Stands

**NEW DESIGN!**

### MS-100 (New Design)

Second Generation Column Studio Monitor Stand with Adjustable Angle/Axis and Acoustic Foam Pads - Black or Red Accents

**Specs:**

- Sold in Pairs
- Load Capacity: 75 lbs. (34,1 kg)
- Height: 38" (965 mm)
- Top Plate: 12" x 10.25" (305 mm x 260 mm)
- Base Diameter: 19" (482 mm)
- Weight: 12.4 lbs. (5,6 kg)



Adjust angle and axis of studio monitor.



Internal channels for dampening and cable management.



Sonic isolation and decoupling throughout.



Rubber foot caps and spikes included.



### MS-90 (New Design)

Second Generation Column Studio Monitor Stand with Non-marring Decoupling Pads - Black or Red Accents, 36" or 45" Height

**Specs:**

- Sold in Pairs
- Load Capacity: 75 lbs. (34,1 kg)
- MS-90/36 Height: 36" (914mm)
- MS-90/45 Height: 45" (1143mm)
- Top Plate: 10.25" x 10.25" (260 mm x 260 mm)
- Base Diameter: 19" (482mm)
- MS-90/36 Weight (before filling column): 9.6 lbs. (4,4 kg)
- MS-90/45 Weight (before filling column): 10.7 lbs. (4,8 kg)



Non-marring decoupling pads.



Internal channels for cable and dampening management.



Sonic isolation and decoupling throughout.



Rubber foot caps and spikes included.



### MS-80, item #17379 (New Design)

Angle-adjustable Desktop Studio Monitor Stands with Acoustic Foam Pads and Rubber Spiked Feet

**Specs:**

- Sold in Pairs
- Load Capacity: 75 lbs. (34,1 kg)
- Top Plate: 12" x 10.25" (305 mm x 260 mm)
- Weight: 3.1 lbs. (1,4 kg)

**NEW FEATURE**

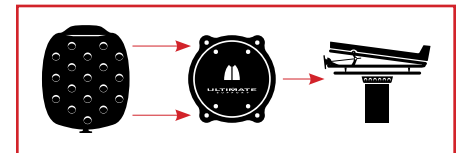

**OPTIONAL CONFIGURATION (SOLD SEPARATELY)**  
Combine the MS-80B to the New MS-90, then adjust angle and axis on a column monitor stand.

Foam padding and rubber feet for sonic isolation.



Adjust the angle of your desktop speakers - up or down!



2011

2013

2017



Over **40** Years of Innovation



## Professional Laptop Mounts & Stands

[click on product links](#)

[Compact Laptop Stand P. 32](#)

HYP-1010

[Laptop Mount & Stand Accessories P. 33](#)

QR-5

QR-1

[Laptop Mount & Stands P. 32-33](#)

LPT-1000QR

HYM-100QR



## Professional Laptop Mounts & Stands

### Compact Laptop Stand

#### HYP-1010, 17981

Hyper® Series Ergonomic Compact Laptop Stand

**Specs:**

- Max Usable Height: 13" (330mm)
- Minimum Usable Height: 4" (102mm)
- Support Arm Width: 9.875" (251mm)
- Support Arm Depth: 8" (203)
- Folded Width: 11.75" (298mm)
- Folded Height: 1.25" (32mm)
- Folded Length: 13.25" (337)
- Weight: 4.95 lbs. (2.2 kg)



**BAG INCLUDED!**

### Laptop Mount & Stands

#### HyperStation QR, 17510

Desktop and 5/8" Thread Mountable Laptop/DJ Stand with Angle-adjustable Telescoping Support Arms, Height-adjustable Second Tier, and QuickRelease™ Center Post

**Specs:**

- Height: 12.5" (318mm)
- Base Width: 10.25" (260mm)
- Base Depth: 10.5" (267mm)
- Arms Width: 10.25" (260mm)
- Arms Depth (inside): 8.0" – 13" (203mm – 330mm)
- Second Tier Width: 6.25" (159mm)
- Second Tier Depth: 8.5" (216mm)
- Folded Dimensions: 2.5" x 10.5" x 13" (64mm x 267mm x 330mm)
- Weight: 6.85 lbs. (3.1 kg)



Mounted on HyperStation QR base



Mounted on included t-stand adapter



**BAG INCLUDED!**



Mounted on microphone stand



QuickRelease adapter for microphone stands





## Professional Laptop Mounts & Stands

### Laptop Mount & Stands (Con.)

#### HyperMount QR, 17511

Desktop and 5/8" Thread  
Mountable Laptop/DJ Stand with  
Angle-adjustable Telescoping Support  
Arms, Height-adjustable Second Tier,  
and QuickRelease™ Center Post

**Specs:**

- Height: 5.75" (146mm)
- Height w/T-Stand: 6.75" (171mm)
- Arms Width: 10.25" (260mm)
- Arms Depth (inside): 8.0" – 13"  
(203mm – 330mm)
- Folded Dimensions: 1.5" x 10.5" x 13"  
(38mm x 267mm x 330mm)
- Weight: 3.35 lbs. (1.5 kg)



### Laptop Mount & Stand Accessories

#### QR-5, item #17516

Five (5) QuickRelease  
Adapters for Microphone  
Stands and Microphone Clips  
& Free Carrying Case Bundle

- Five QR-1 adapters included
- Handy carrying case for FREE!
- Quickly swap mics on stands
- 2-piece QuickRelease adapter
- Made from strong steel



#### QR-1, item #17512

QuickRelease Adapter for  
Microphone Stands and  
Microphone Clips

- 2-piece QuickRelease  
Adapters
- Made from strong steel





2011

2016



Over **40** Years of Innovation



## Professional Instrument Soft Cases & Table Covers

[click on product links](#)

### Guitar Bags P. 35-36

USHB2-AG-BK  
USHB2-AG-BL  
USHB2-AG-GR  
USHB2-AG-RD  
USHB2-EG-BK  
USHB2-EG-BL  
USHB2-EG-GR  
USHB2-EG-RD  
USHB2-EB-BK  
USHB2-EB-BL  
USHB2-EB-GR  
USHB2-EB-RD

### Keyboard Bags P. 36

USHB2-KB61-BK  
USHB2-KB61-BL  
USHB2-KB61-GR  
USHB2-KB61-RD

### Drum Bags P. 37

USHB2-SN-BK  
USHB2-SN-BL  
USHB2-SN-GR  
USHB2-SN-RD

### Table Covers P. 37

USDJ-4TCB  
USDJ-5TCB  
USDJ-6TCB  
USDJ-8TCB  
USDJ-4TCW  
USDJ-5TCW  
USDJ-6TCW  
USDJ-8TCW



## Professional Instrument Soft Cases

### Hybrid 2.0 – Acoustic Guitar Soft Cases

USHB2-AG-BK, item #17734

USHB2-AG-BL, item #17733

USHB2-AG-GR, item #17731

USHB2-AG-RD, item #17732

Soft case for acoustic & hollow body guitars with backpack straps, water resistant exterior, and storage pocket. Black with black, blue, gray or red trim.

**Specs:**

- Weight: 7.3 lbs. (3.3 kg)
- Outside Measurements: Neck Width - 8.5" (000mm), Body Width - 19" (000mm), Height - 44.5" (0000mm), Depth - 5.5" (000mm)
- Inside Measurements: Neck - 6.5" (000mm), Body - 17" (000mm), Height - 41.5" (0000mm), Depth - 3.5" (00mm)
- Inside Height without base Insert: 43.5" (000mm)
- Outer material: 840D Nylon Dobby
- Inner material: Nylex (Polyester Flocking Fabric)
- Three Adjustable Padded inserts
- One Outside pocket

Added rubber protective base, strong shoulder straps and handles.



Thick padding all around with adjustable padded inserts.



Included compartment for accessories.



### Hybrid 2.0 – Electric Guitar Soft Cases

USHB2-EG-BK, item #17727

USHB2-EG-BL, item #17714

USHB2-EG-GR, item #17708

USHB2-EG-RD, item #17713

Soft case for electric guitars with backpack straps, water resistant exterior, and storage pocket. Black with black, blue, gray or red trim.

**Specs:**

- Weight: 6.35 lbs. (2.9 kg)
- Outside Measurements: Neck Width - 8.5" (216mm), Body Width - 16.42" (417mm), Height - 50" (1270mm), Depth - 4.5" (114mm)
- Inside Measurements: Neck - 6.5" (165mm), Body - 14.42" (366mm), Height - 41.5" (1054mm), Depth - 3.17" (80mm)
- Inside Height without base Insert: 43.5" (81mm)
- Outer material: 840D Nylon Dobby
- Inner material: Nylex (Polyester Flocking Fabric)
- Three Adjustable Padded inserts
- One Outside pocket

Added rubber protective base, strong shoulder straps and handles.



Interior 1" to 2" thick padding all around with adjustable padded inserts.



Included compartment for accessories.





## Professional Instrument Soft Cases

### Hybrid 2.0 – Electric Bass Guitar Soft Cases

USHB2-EB-BK, item #17729

USHB2-EB-BL, item #17720

USHB2-EB-GR, item #17712

USHB2-EB-RD, item #17719

Soft case for electric bass guitars with backpack straps, water resistant exterior, and storage pocket. Black with black, blue, gray or red trim.

**Specs:**

- Weight: 6.35 lbs. (2.9 kg)
- Outside Measurements: Neck Width - 8.5" (216mm), Body Width - 16.42" (417mm), Height - 50" (1270mm), Depth - 4.5" (114mm)
- Inside Measurements: Neck - 6.5" (165mm), Body - 14.42" (366mm), Height - 47" (1194mm), Depth - 2.5" (63.5mm)
- Inside Height without base Insert: 49" (1244mm)
- Outer material: 840D Nylon Dobby
- Inner material: Nylex (Polyester Flocking Fabric)
- Three Adjustable Padded inserts
- One Outside pocket

Added rubber protective base, strong shoulder straps and handles.



Thick padding all around with adjustable padded inserts.



Included compartment for accessories.



### Hybrid 2.0 – 61 Note Keyboard Soft Cases

USHB2-KB61-BK, item #17730

USHB2-KB61-BL, item #17716

USHB2-KB61-GR, item #17709

USHB2-KB61-RD, item #17715

Soft case for 61 note keyboards and controllers with backpack straps, water resistant exterior, and storage pocket. Black with black, blue, gray or red trim.

**Specs:**

- Weight: 6.25 lbs. (2.8 kg)
- Outside Measurements: Width - 16" (406mm), Height - 42" (1067mm), Depth - 6" (152mm)
- Inside Measurements: Width - 14" (356mm), Height - 40" (1016mm), Depth - 4" (102mm)
- Outer material: 840D Nylon Dobby
- Inner material: Nylex (Polyester Flocking Fabric)
- Three Adjustable Padded inserts
- One Outside pocket

Thick padding all around with added adjustable padded inserts.



Added rubber protective base, strong shoulder straps and handles.



Included compartment for accessories.







## Professional Instrument Soft Cases & Table Covers

### Hybrid 2.0 Snare Drum Soft Cases

USHB2-SN-BK, item #17710

USHB2-SN-BL, item #17737

USHB2-SN-GR, item #17735

USHB2-SN-RD, item #17736

Soft case for snare drum bag with shoulder strap, water resistant exterior, and storage pocket. Black with black, blue, gray or red trim.

**Specs:**

- Outer material: 840D Nylon Dobby
- Inner material: Nylex (Polyester Flocking Fabric)
- Diameter: 20.5"
- Height: 8.5"
- Inside diameter: 18.5"
- Inside height: 6.5"1" of padding all around



Interior 1" thick padding all around with added adjustable padded inserts.



Added rubber protective base, strong shoulder straps and handles.



Two adjustable inserts



### Table Covers

#### 4, 5, 6, & 8 Foot Black/White Table Covers

Durable, Fire-resistant Polyester Table Covers

**Features:**

- Polyester material
- Wash in cold water gentle cycle, tumble dry
- Fire-resistant material

**Table Cover (Black, 4 ft.)**

- Part Name: USDJ-4TCB
- Part Number: 17413
- 24" deep x 29" high

**Table Cover (White, 4 ft.)**

- Part Name: USDJ-4TCW
- Part Number: 17414
- 24" deep x 29" high

**Table Cover (Black, 5 ft.)**

- Part Name: USDJ-5TCB
- Part Number: 17415
- 30" deep x 29" high

**Table Cover (White, 5 ft.)**

- Part Name: USDJ-5TCW
- Part Number: 17416
- 30" deep x 29" high

**Table Cover (Black, 6 ft.)**

- Part Name: USDJ-6TCB
- Part Number: 17417
- 30" deep x 29" high

**Table Cover (White, 6 ft.)**

- Part Name: USDJ-6TCW
- Part Number: 17418
- 30" deep x 29" high

**Table Cover (Black, 8 ft.)**

- Part Name: USDJ-8TCB
- Part Number: 17419
- 30" deep x 29" high

**Table Cover (White, 8 ft.)**

- Part Name: USDJ-8TCW
- Part Number: 17420
- 30" deep x 29" high



**BAG INCLUDED!**

**BAG INCLUDED!**

Over 40 Years of Innovation



2018 Catalog



## **X-ON Electronics**

Largest Supplier of Electrical and Electronic Components

*Click to view similar products for [ultimate support manufacturer](#):*

Other Similar products are found below :

[HYP-1010](#) [JS-SRR100](#) [BMB-200K](#) [TS-90B](#)