

Model GMDIO - Graphite® Digital Module



- ADDS I/O CAPABILITY TO THE GRAPHITE PRODUCTS
- EIGHT INPUT, SIX OUTPUT DIGITAL MODULE
- INPUTS ISOLATED FROM OUTPUTS
- INPUTS INDEPENDENTLY SWITCH SELECTABLE FOR SINK OR SOURCE SIGNALS
- INPUTS INDEPENDENTLY CONFIGURABLE FOR HIGH OR LOW ACTIVE STATE
- INPUTS INDEPENDENTLY SWITCH SELECTABLE FOR HIGH OR LOW FREQUENCY SIGNALS
- RELAY OR NFET OUTPUT MODELS AVAILABLE



FOR USE IN HAZARDOUS LOCATIONS:
 Class I, Division 2, Groups A, B, C, and D
 T4



II 3 G Ex nA IIC T4 Gc
 -40°C ≤ T_{AMB} ≤ 75°C
 DEMKO 14 ATEX 1387X
 IECEx UL 15.0035X



For Model No. GMDIOS00 Only

For Model No. GMDIOS00 Only

GENERAL DESCRIPTION

The Model GMDIO14 module is a digital I/O module designed for use with the Graphite products. This module offers eight inputs and six outputs that can be used to monitor contact or sensor inputs and actuate relays, solenoids, PLC inputs, etc.

The inputs accept standard DC inputs or contact closures, and are configured for Sink/Source signals via external switches. Additionally, each input has a switch selectable input filter that can be used to prevent contact bounce. Each input may also be software configured as a high-active or low-active input.

The module is available with relay or NFET outputs that are capable of switching up to one amp each (NFET DC only). For applications requiring large loads to be controlled, several DIN rail mount relays are available.

The modules connect and communicate via proprietary USB connection to the various Graphite host devices. The Graphite host devices, equipped with serial ports as well as an Ethernet port(s), allows the system to share data with PCs, PLCs, and SCADA systems. The maximum number of modules varies for each Graphite host device, see specific models for details.

Once programmed, the module will continue to operate/control independent of the Graphite host device as long as power is applied. Remove power from the host device before installing or replacing any modules.

CONFIGURATION

The Graphite is configured with Windows® compatible Crimson® software. The software is an easy to use, graphical interface which provides a means of configuration and commissioning of new systems, as well as routine module re-calibration.

SAFETY SUMMARY

All safety related regulations, local codes and instructions that appear in this literature or on equipment must be observed to ensure personal safety and to prevent damage to either the instrument or equipment connected to it. If equipment is used in a manner not specified by the manufacturer, the protection provided by the equipment may be impaired.

Do not use this unit to directly command motors, valves, or other actuators not equipped with safeguards. To do so can be potentially harmful to persons or equipment in the event of a fault to the unit.

DIMENSIONS In inches (mm)

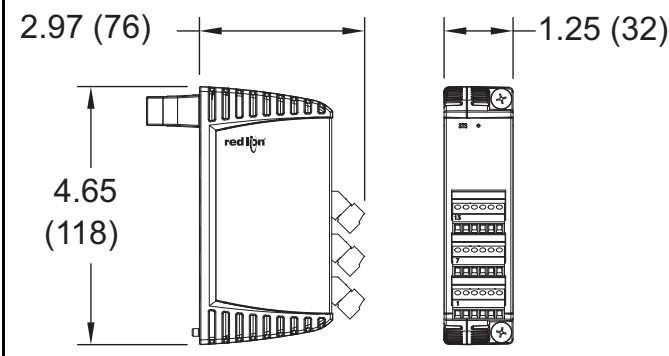

CAUTION: Risk of Danger.

Read complete instructions prior to installation and operation of the unit.



WARNING - EXPLOSION HAZARD - DO NOT DISCONNECT EQUIPMENT UNLESS POWER HAS BEEN SWITCHED OFF OR AREA IS KNOWN TO BE NON-HAZARDOUS.



WARNING - EXPLOSION HAZARD - SUBSTITUTION OF COMPONENTS MAY IMPAIR SUITABILITY FOR CLASS I, DIVISION 2.

GENERAL SPECIFICATIONS

1. **POWER:** Power will be supplied by the Graphite host device. Some modules, depending on usage may consume high levels of power. This may limit the total number of modules that can be installed on a single Graphite host. Check the Graphite module and Graphite host data sheets for specific usage and power requirements.

GMDIO14 Max Power: 3.6 W

2. **LEDs:**

STS - Status LED shows module condition.
 IN1-IN8 - LEDs are lit when associated input is active.
 OP1-OP6 - LEDs are lit when associated output is active.

3. **MEMORY:** Non-volatile memory retains all programmable parameters.

4. **INPUTS:** DIP switch selectable for sink or source
 Maximum voltage: +30 VDC, reverse polarity protected
 Off Voltage: < 1.2 Volts
 On Voltage: > 3.8 Volts
 Input Impedance: Source Mode 10K ohms; Sink Mode 20K ohms
 Input Frequency*:

Filter switch on: 50 Hz
 Filter switch off: 300 Hz
 * Actual useable frequency limited by communication to external device.

5. **OUTPUTS:** Outputs available as FORM-A relay or Solid State NFET.

Form A Relay Output:

Type: N.O.
 The following pairs of relays share the common terminal: 1&2, 3&4, 5&6
 Current Rating by pair: 3 Amps @ 30 VDC / 125 VAC resistive
 1/10 HP @ 125 VAC
 Life Expectancy: 200,000 cycles at maximum load rating.
 (Decreasing load, increasing cycle time, and use of surge suppression such as RC snubbers increases life expectancy.)

Solid State Output:

Type: Switched DC, N Channel open drain MOSFET
 Contact Rating: 1 ADC max
 VDS ON: < 0.2 V @ 1 A
 VDS MAX: 30 VDC
 Offstate Leakage Current: 0.5 mA max

6. **ISOLATION LEVEL:** 500 Vrms @ 50/60 Hz for 1 minute between the following:

- Inputs
- Outputs
- Graphite Host Power Supply Input

7. **COMMUNICATIONS:** Provided by the Graphite host device

8. **ENVIRONMENTAL CONDITIONS:**

Operating Temperature Range:
 GMDIOR00: -40 to 70 °C
 GMDIOS00: -40 to 75 °C
 Operating temperature is limited to lowest range among equipment used in your Graphite system. Consult the user manual or www.redlion.net/OpTemp for further details.

Storage Temperature Range: -40 to +85 °C
 Shock to IEC 68-2-27: Operational 40 g (10 g, modules w/relays)

Operating and Storage Humidity: 85% max. Relative humidity, non-condensing

Altitude: Up to 2000 meters

9. **CERTIFICATIONS AND COMPLIANCES:**

CE Approved

EN 61326-1 Immunity to Industrial Locations
 IEC/EN 61010-1
 RoHS Compliant

ATEX Approved (GMDIOS00 only)

Ⓜ II 3 G Ex nA IIC T4 Gc
 DEMKO 14 ATEX 1387X
 EN 60079-0, -15

IECEx Approved (GMDIOS00 only)

Ex nA IIC T4 Gc
 IECEx UL 15.0035X
 IEC 60079-0, -15

UL Listed: File #E302106

UL Hazardous: File #E317425 (GMDIOS00 only)

ABS Type Approval for Shipboard Applications

10. **CONSTRUCTION:** Case body is all metal construction.

11. **CONNECTIONS:** Removable wire clamp screw terminal blocks
 Wire Gage: 28-16 AWG (0.32 mm - 1.29 mm) terminal gage wire
 Torque: 1.95-2.21 inch-lbs (0.22-0.25 N-m)

12. **MOUNTING:** Screws to host

13. **WEIGHT:** 8 oz (224 g)

Block Diagram

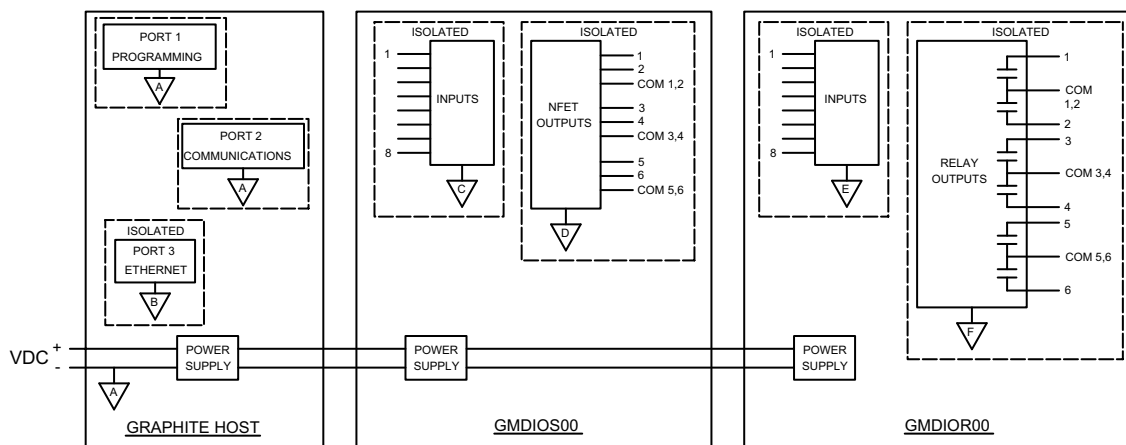

EMC INSTALLATION GUIDELINES

Although Red Lion Controls products are designed with a high degree of immunity to Electromagnetic Interference (EMI), proper installation and wiring methods must be followed to ensure compatibility in each application. The type of the electrical noise, source or coupling method into a unit may be different for various installations. Cable length, routing, and shield termination are very important and can mean the difference between a successful or troublesome installation. Listed are some EMI guidelines for a successful installation in an industrial environment.

1. A unit should be mounted in a metal enclosure, which is properly connected to protective earth.
2. Use shielded cables for all Signal and Control inputs. The shield connection should be made as short as possible. The connection point for the shield depends somewhat upon the application. Listed below are the recommended methods of connecting the shield, in order of their effectiveness.
 - a. Connect the shield to earth ground (protective earth) at one end where the unit is mounted.
 - b. Connect the shield to earth ground at both ends of the cable, usually when the noise source frequency is over 1 MHz.
3. Never run Signal or Control cables in the same conduit or raceway with AC power lines, conductors, feeding motors, solenoids, SCR controls, and heaters, etc. The cables should be run through metal conduit that is properly grounded. This is especially useful in applications where cable runs are long and portable two-way radios are used in close proximity or if the installation is near a commercial radio transmitter. Also, Signal or Control cables within an enclosure should be routed as far away as possible from contactors, control relays, transformers, and other noisy components.
4. Long cable runs are more susceptible to EMI pickup than short cable runs.
5. In extremely high EMI environments, the use of external EMI suppression devices such as Ferrite Suppression Cores for signal and

control cables is effective. The following EMI suppression devices (or equivalent) are recommended:

Fair-Rite part number 0443167251 (Red Lion Controls #FCOR0000)

Line Filters for input power cables:

Schaffner # FN2010-1/07 (Red Lion Controls #LFIL0000)

6. To protect relay contacts that control inductive loads and to minimize radiated and conducted noise (EMI), some type of contact protection network is normally installed across the load, the contacts or both. The most effective location is across the load.
 - a. Using a snubber, which is a resistor-capacitor (RC) network or metal oxide varistor (MOV) across an AC inductive load is very effective at reducing EMI and increasing relay contact life.
 - b. If a DC inductive load (such as a DC relay coil) is controlled by a transistor switch, care must be taken not to exceed the breakdown voltage of the transistor when the load is switched. One of the most effective ways is to place a diode across the inductive load. Most Red Lion products with solid state outputs have internal zener diode protection. However external diode protection at the load is always a good design practice to limit EMI. Although the use of a snubber or varistor could be used.
Red Lion part numbers: Snubber: SNUB0000
Varistor: ILS11500 or ILS23000
7. Care should be taken when connecting input and output devices to the instrument. When a separate input and output common is provided, they should not be mixed. Therefore a sensor common should NOT be connected to an output common. This would cause EMI on the sensitive input common, which could affect the instrument's operation.

Visit www.redlion.net/emi for more information on EMI guidelines, Safety and CE issues as they relate to Red Lion products.

HARDWARE

INPUT SWITCHES

Each input is independently configurable for sinking or sourcing signals. A filter capacitor is also selectable for avoiding contact bounce.

SNK/SRC:

- ON-SRC - Connects an internal 10KΩ pull-down resistor to common.
- OFF-SNK - Connects an internal 20KΩ pull-up resistor to +5V.

FILTER:

- ON - Connects a capacitor to the input, thereby reducing the input response to 50 Hz.
- OFF - Provides maximum input response of 300 Hz.

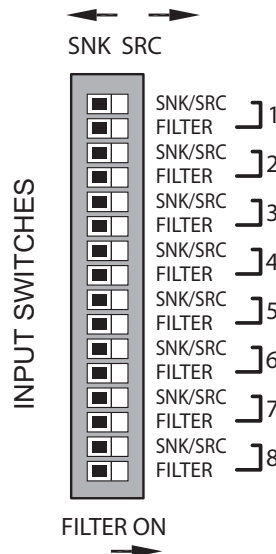

HARDWARE INSTALLATION

The physical order of all installed modules must match the modules order in Crimson. Torque screws to 6.0 pound-force inch [96 ounce-force inch] (0.68 Nm).

WARNING: Disconnect all power to the unit before installing or removing modules.

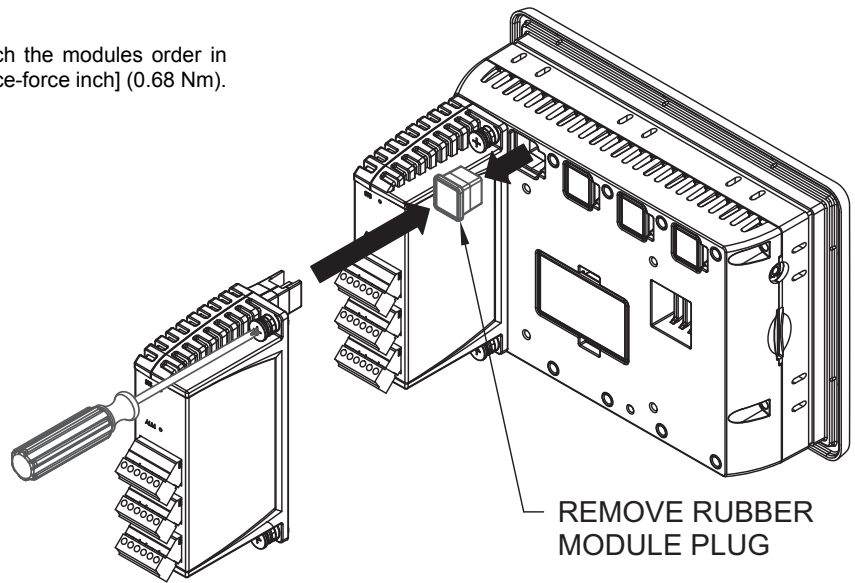

REMOVE RUBBER MODULE PLUG

WIRING

WIRING CONNECTIONS

All conductors should meet voltage and current ratings for each terminal. Also, cabling should conform to appropriate standards of good installation, local codes and regulations and be suitably rated for the temperatures of the environment to which it is being installed. When wiring the module, use the numbers on the label to identify the position number with the proper function. Strip the wire, leaving approximately 1/4" (6 mm) of bare wire exposed. Insert the wire into the terminal, and tighten.

WARNING - EXPLOSION HAZARD - DO NOT CONNECT OR DISCONNECT CABLES WHILE POWER IS APPLIED UNLESS AREA IS KNOWN TO BE NON-HAZARDOUS.

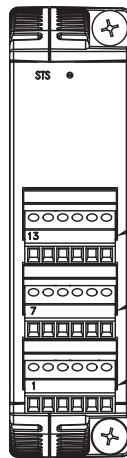

Terminals 13 to 18

Terminals 7 to 12

Terminals 1 to 6

INPUT CONNECTIONS

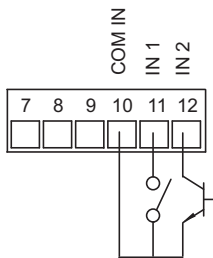
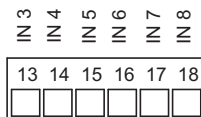
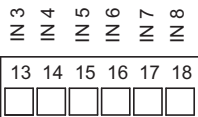

Sinking Input

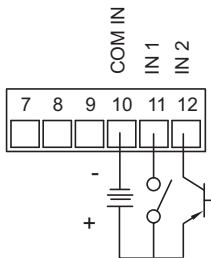

Sourcing Input

OUTPUT CONNECTIONS

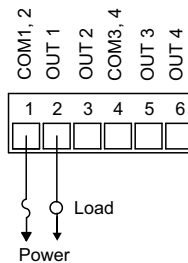
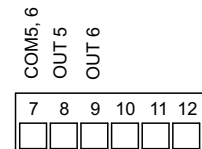
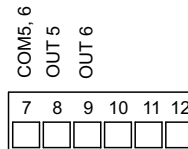

Relay Version

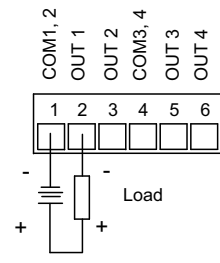

Solid State NFET Version

LEDs

STS – STATUS LED

The Status LED is a green LED that provides information regarding the state of the module. This includes indication of the various stages of the start-up routine (power-up), as well as any errors that may occur.

Startup Routine

Off	Module is currently running the boot loader and/or being flash upgraded by Crimson.
Flashing Green	Module switching to configuration.
Green	Module performing normally.

Error States

Flashing Green	Module is controlling properly, but has lost communication with the Host.
----------------	---

FIRMWARE UPGRADE

The module's firmware is stored in flash memory so that software/hardware conflicts are avoided, and so features can be added in the future.

During a download, Crimson compares its own library of firmware files with those stored in the module. If they do not match, Crimson will download the necessary firmware.

CONFIGURATION

Programming is done via Crimson® software, a Windows® compatible configuration interface. Please see the Crimson manual for more information.

GRAPHITE TROUBLESHOOTING

If for any reason you have trouble operating, connecting, or simply have questions concerning your new Graphite unit, contact Red Lion's technical support.

Email: support@redlion.net

Website: www.redlion.net

Inside US: +1 (877) 432-9908

Outside US: +1 (717) 767-6511

ORDERING INFORMATION

DESCRIPTION	PART NUMBER
Graphite Module, Digital I/O, 8 Inputs And 6 Relays Outputs ¹	GMDIOR00
Graphite Module, Digital I/O, 8 Inputs And 6 Solid State Outputs	GMDIOS00

A listing of the entire Graphite family of products and accessories can be found at www.redlion.net.

¹ Module is not suitable for use in hazardous locations.

This page intentionally left blank

This page intentionally left blank

LIMITED WARRANTY

(a) Red Lion Controls Inc. (the "Company") warrants that all Products shall be free from defects in material and workmanship under normal use for the period of time provided in "Statement of Warranty Periods" (available at www.redlion.net) current at the time of shipment of the Products (the "Warranty Period"). **EXCEPT FOR THE ABOVE- STATED WARRANTY, COMPANY MAKES NO WARRANTY WHATSOEVER WITH RESPECT TO THE PRODUCTS, INCLUDING ANY (A) WARRANTY OF MERCHANTABILITY; (B) WARRANTY OF FITNESS FOR A PARTICULAR PURPOSE; OR (C) WARRANTY AGAINST INFRINGEMENT OF INTELLECTUAL PROPERTY RIGHTS OF A THIRD PARTY; WHETHER EXPRESS OR IMPLIED BY LAW, COURSE OF DEALING, COURSE OF PERFORMANCE, USAGE OF TRADE OR OTHERWISE.** Customer shall be responsible for determining that a Product is suitable for Customer's use and that such use complies with any applicable local, state or federal law.

(b) The Company shall not be liable for a breach of the warranty set forth in paragraph (a) if (i) the defect is a result of Customer's failure to store, install, commission or maintain the Product according to specifications; (ii) Customer alters or repairs such Product without the prior written consent of Company.

(c) Subject to paragraph (b), with respect to any such Product during the Warranty Period, Company shall, in its sole discretion, either (i) repair or replace the Product; or (ii) credit or refund the price of Product provided that, if Company so requests, Customer shall, at Company's expense, return such Product to Company.

(d) **THE REMEDIES SET FORTH IN PARAGRAPH (c) SHALL BE THE CUSTOMER'S SOLE AND EXCLUSIVE REMEDY AND COMPANY'S ENTIRE LIABILITY FOR ANY BREACH OF THE LIMITED WARRANTY SET FORTH IN PARAGRAPH (a).**

X-ON Electronics

Largest Supplier of Electrical and Electronic Components

Click to view similar products for [red lion manufacturer:](#)

Other Similar products are found below :

[IFMA0035](#) [SL-5ES-1](#) [LD400400](#) [PAXI0020](#) [WI0006OF](#) [508TX-A](#) [PAX2A000](#) [ZBH06002](#) [CBLGEN01](#) [1000-POE+](#) [CUB4LP40](#) [SLX-8ES-1](#) [TORF1000](#) [WF1000BF](#) [FANWAND721SMA](#) [FCOPPER-SFP-100](#) [PSDR060W](#) [SLX-5ES-1](#) [309FXE-ST-15](#)
[CRM000CMCMOD0000](#) [CRM000CMDN000000](#) [CR10001000000210](#) [CR30001000000420](#) [PAXDP000](#) [NT24K-16M12-POE-PT](#) [NT24K-16M12-POE-R](#) [NT24K-16M12-POE-R-PT](#) [NT24K-16M12-PT](#) [NT24K-16M12-R-PT](#) [IAMA6262](#) [FMFIBER-SFP-4K](#) [PAXS0000](#)
[CCARPG01](#) [PAXLA000](#) [CUB4CL20](#) [PSAC0000](#) [CUB5USB0](#) [516TX](#) [102MCE-SC-15](#) [304TX](#) [CUB5TCB0](#) [LMPCC000](#) [ENC5A000](#)
[ENC8A000](#) [308TX](#) [508TX](#) [7018TX](#) [708FX2-SC](#) [516TX-A](#) [C48CS003](#)