

Bulk Metal® Technology High Precision, Current Sensing, Power Surface Mount, Metal Strip Resistor with Resistance Value from 1 mΩ, Rated Power up to 3 W and TCR to 0 ± 15 ppm/°C Maximum

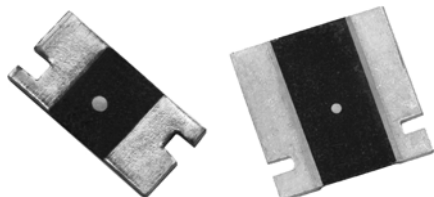

No minimum order quantity and any value at any tolerance available within resistance range.

The Vishay Foil Resistors (VFR) application engineering department is available to advise and make recommendations.

For non-standard technical requirements and special applications, please contact foil@vpgsensors.com.

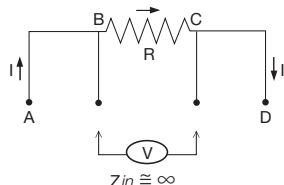

Four terminal (Kelvin) design: allows for precise and accurate measurements.

FIGURE 1 - POWER DERATING CURVE

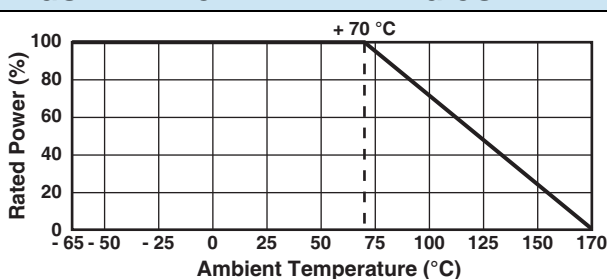

TABLE 1 - SPECIFICATIONS

PARAMETER	CSM2512	CSM3637
Resistance Range	1 mΩ to 200 mΩ	
Power Rating at 70 °C	1 W ⁽¹⁾	3 W (1 mΩ to 10 mΩ) 2 W (> 10 mΩ to 200 mΩ)
Maximum Current ⁽²⁾	31 A	54 A
Tolerance	± 0.5 % (1 mΩ to < 3 mΩ) ± 0.1 % (3 mΩ to 200 mΩ)	± 0.5 % (1 mΩ to < 2 mΩ) ± 0.1 % (2 mΩ to 200 mΩ)
Temperature Coefficient Max. (- 55 °C to + 125 °C, + 25 °C Ref.)	± 50 ppm/°C (1 mΩ to < 3 mΩ) ± 15 ppm/°C (3 mΩ to 200 mΩ) ± 10 ppm/°C (3 mΩ to 10 mΩ) is available on request ⁽³⁾	± 25 ppm/°C (1 mΩ to < 3 mΩ) ± 15 ppm/°C (3 mΩ to 200 mΩ) ± 10 ppm/°C (1 mΩ to 10 mΩ) is available on request ⁽³⁾
Operating Temperature Range	- 65 °C to + 170 °C	
Maximum Working Voltage	$(P \times R)^{1/2}$	
Weight (Maximum)	0.09 g	0.29 g

Notes

⁽¹⁾ For values above 0.1 Ω derate linearly to 80 % rated power at 0.5 Ω

⁽²⁾ Maximum current for a given resistance value is calculated using $I = \sqrt{P/R}$

⁽³⁾ Please contact application engineering: foil@vpgsensors.com

* This datasheet provides information about parts that are RoHS-compliant and/or parts that are non-RoHS-compliant. For example, parts with lead (Pb) terminations are not RoHS compliant. Please see the information/tables in this datasheet for details.

FEATURES

- Temperature coefficient of resistance: ± 15 ppm/°C max. (- 55 °C to + 125 °C, + 25 °C ref.); ± 10 ppm/°C max. (- 55 °C to + 125 °C, + 25 °C ref.) is available on request (see table 1)
- Power rating: 1 W to 3 W
- Resistance tolerance: ± 0.1 %
- Resistance range: 1 mΩ to 200 mΩ
- Bulk Metal® Foil resistors are not restricted to standard values, specific "as required" values can be supplied at no extra cost or delivery (e.g. 2.3456 mΩ vs. 2 mΩ)
- Load life stability to ± 0.2 % (70 °C, 2000 h at rated power)
- Short time overload: ± 0.1 % typical
- Thermal EMF: 3 μV/°C (DC offset error, significant for low values)
- Maximum current: up to 54 A
- Proprietary processing techniques produce low TCR, tight tolerance and improve stability
- Low inductance < 5 nH
- Solderable terminations
- Excellent frequency response to 50 MHz
- Matched sets are available on request
- Screening in accordance with EEE-INST002 available (per MIL-PRF-55342 and MIL-PRF-49465; see 303144 and 303145 datasheets)
- Terminal finishes available: lead (Pb)-free, tin/lead alloy
- Quick prototype quantities available, please contact foil@vpgsensors.com
- For better performance please contact Application Engineering
- Compliant to RoHS directive 2002/95/EC



ABOUT CSM (Low Ohm Value 1 mΩ to 200 mΩ)

New high-precision Bulk Metal[®] surface-mount Power Metal Strip[®] resistor of 1 mΩ to 200 mΩ that features an improved load-life stability of $\pm 0.2\%$ at +70 °C for 2000 h at rated power, an absolute TCR of ± 15 ppm/°C maximum from -55 °C to +125 °C, +25 °C ref., and a tolerance of $\pm 0.1\%$.

Typical current sensing resistors offer a load-life stability of $\geq 1\%$ through a 2000 h workload. The improved resistance stability of the CSM Series makes it ideal for tightened-stability voltage division and precision current sensing applications in switching linear power supplies, power amplifiers, measurement instrumentation, bridge networks, and medical and test equipment. In addition, the CSM Series complies with EEE-INST-002 (MIL-PRF 55342 and MIL-PRF 49465) for military and space applications.

Traditional Passive current sensors and shunts generate heat under power, which changes their resistance, and thus their voltage output. The CSM's low absolute TCR reduces errors due to temperature gradients, thus reducing a major source of uncertainty in current measurement. The CSM can withstand unconventional environmental conditions, including the extremely high temperatures and radiation-rich environments of down-hole oil exploration and well logging, or the deep-sea underwater repeaters in cross-ocean communications.

The stability of the CSM can be further enhanced by post-manufacturing operations (PMO), such as temperature cycling, short-time overload, and accelerated load life which are uniquely applicable to Bulk Metal[®] Foil resistors.

The device features a low thermal electromotive force (EMF) that is critical in many precision applications. The CSM's all-welded construction is composed of a Bulk Metal[®] resistive element with welded copper terminations, plated for soldering. The terminations make true ohmic contact with the resistive layer along the entire side of the resistive element, thereby minimizing temperature variations. Also, the resistor element is designed to uniformly dissipate power without creating hot spots, and the welded terminations material is compatible with the element material.

These design factors result in a very low thermal-EMF ($3 \mu\text{V}/^\circ\text{C}$) resistor, because in addition to the low thermal EMF compatibility of the metals, the uniformity and thermal efficiency of the design minimizes the temperature differential across the resistor, thereby assuring low thermal EMF generation at the leads. This further reduces the "battery effect" exhibited by most current-sensing or voltage-reference resistors. Thus, the parasitic voltage generated at the junction of two dissimilar metals, which is especially important in low-value current-sensing resistors, is minimized, while the pure current-to-voltage conversion is protected from such interference in DC applications.

The stability problems associated with analog circuits are very pervasive, but knowledgeable selection of a few high-quality resistors, networks, or trimming potentiometers

in critical locations can greatly improve circuit performance, long-term application-related performance, as well as the designer's peace-of-mind.

Additionally, the overall system cost is often reduced when a knowledgeable designer concentrates costs in a few exceptionally stable components whose proven minimal-deviation load and environmental stability can often eliminate the necessity of additional compensating circuitry or temperature-controlling systems. The higher reliability and better overall system performances also achieve excellent product results in the field, enhancing market acceptance and product reputation.

Designers often unnecessarily pay for tighter tolerances than required simply to accommodate the resistance stability shifts they know to be imminent in an application due to the large application-related changes in the components they selected. Selection of a high-stability component like the CSM in these applications eliminates the need for shift allowance due to "planned instability" and allows the use of looser initial tolerances than would be necessary with current-sensing resistors based on other technologies.

The Key Applications

Applications requiring accuracy and repeatability under stress conditions such as the following:

- Switching and linear power supplies
- Precision current-sensing
- Power management systems
- Feedback circuits
- Power amplifiers
- Measurement instrumentation
- Precision instrumentation amplifiers
- Medical and automatic test equipment
- Satellites and aerospace systems
- Commercial and Military avionics
- Test and measurement equipment
- Electronic scales

FIGURE 2 - DIMENSIONS AND IMPRINTING in inches (millimeters)

CSM2512 DIMENSIONS

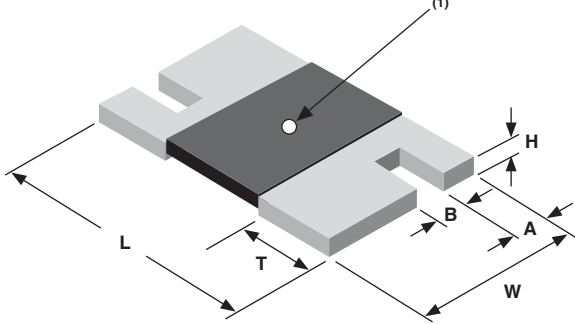

CSM3637 DIMENSIONS

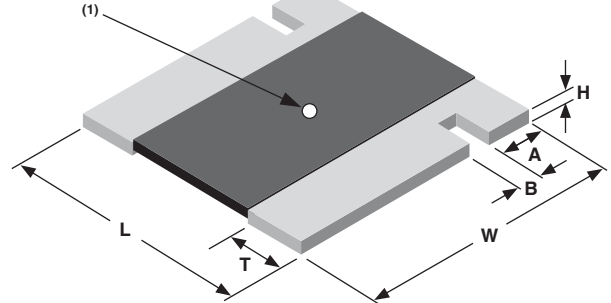

CSM2512 LAND PATTERN

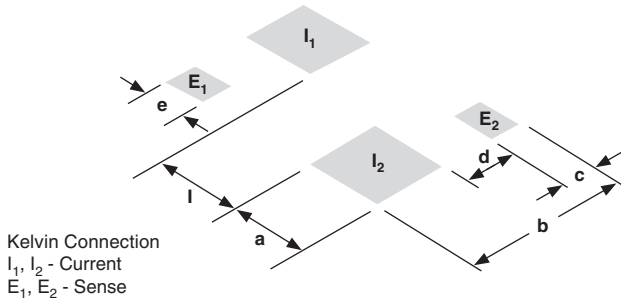

CSM3637 LAND PATTERN

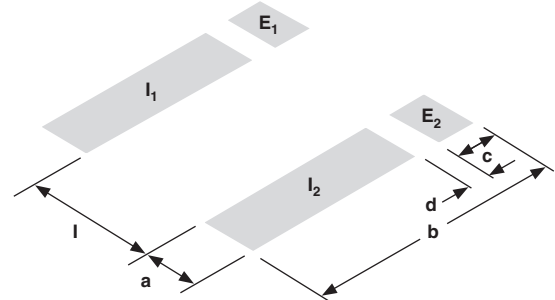

DIMENSIONS - TOLERANCES ± 0.010 (± 0.254), * ± 0.015 (± 0.381)

MODEL	RESISTANCE RANGE (mΩ)	L	W	H	T	A	B
CSM2512	1 to < 5	0.250 (6.350)	0.125 (3.175)	0.025 (0.635)	0.087 (2.210)	0.030 (0.762)*	0.032 (0.813)*
	5 to < 7				0.047 (1.194)		
	7 to 200				0.030 (0.762)		
CSM3637	1 to < 2	0.360 (9.144)	0.370 (9.398)	0.025 (0.635)	0.138 (3.505)	0.061 (1.55)	0.032 (0.813)
	2 to 200	0.360 (9.144)	0.370 (9.398)	0.025 (0.635)	0.086 (2.184)	0.061 (1.549)	0.032 (0.813)

LAND PATTERN DIMENSIONS - TOLERANCES ± 0.003 (± 0.076)

MODEL	RANGE	a	b	c	d	e	l
CSM2512	0R001 to 0R0049	0.120 (3.05)	0.145 (3.68)	0.045 (1.14)	0.021 (0.53)	0.055 (1.39)	0.050 (1.27)
	0R005 to 0R0069	0.083 (2.10)	0.145 (3.68)	0.045 (1.14)	0.021 (0.53)	0.055 (1.39)	0.125 (3.17)
	0R007 to 0R2	0.065 (1.65)	0.145 (3.68)	0.045 (1.14)	0.021 (0.53)	0.055 (1.39)	0.160 (4.06)
CSM3637	0R001 to 0R0019	0.168 (4.27)	0.390 (9.91)	0.066 (1.68)	0.024 (0.610)	-	0.074 (1.88)
	0R002 to 0R2	0.116 (2.95)	0.390 (9.91)	0.066 (1.68)	0.024 (0.610)	-	0.178 (4.52)

Note

(1) White dot indicates top side of part for mounting purposes

TABLE 2 - CSM SERIES PERFORMANCE SPECIFICATIONS				
TEST	CONDITIONS	MIL-PRF-49465B ΔR LIMITS	CSM2512/CSM3637	
			TYPICAL ΔR LIMITS	MAXIMUM ΔR LIMITS
Thermal Shock	- 55 °C to + 150 °C, 1000 cycles, 15 min at each extreme	± (0.5 % + 0.0005R)	0.1 %	0.3 %
Load Life Stability	2000 h, 70 °C at rated power	± (1.0 % + 0.0005R)	0.2 %	1.0 %
Bias Humidity	+ 85 °C, 85 % humidity 10 % bias, 1000 h	± (0.5 % + 0.0005R)	0.05 %	0.2 %
Short Time Overload	5 x rated power for 5 s (See note ⁽³⁾ from table 1)	± (0.5 % + 0.0005R)	0.1 %	0.3 %
High Temperature Exposure	1000 h, 170 °C	± (1.0 % + 0.0005R)	0.2 %	0.3 %
Low Temperature Storage	- 65 °C for 24 h	± (0.5 % + 0.0005R)	0.05 %	0.1 %
Moisture Resistance	MIL-STD-202, method 106, 0 power, 7a and 7b not required	± (0.5 % + 0.0005R)	0.02 %	0.05 %
Shock	100 g, 6 ms, 5 pulses	± (0.1 % + 0.0005R)	0.02 %	0.05 %
Vibration	(10 Hz to 2000 Hz) 20 g	± (0.1 % + 0.0005R)	0.02 %	0.05 %
Resistance to Soldering Heat	10 s to 12 s at + 260 °C	± (0.25 % + 0.0005R)	0.05 %	0.1 %
Solderability	MIL-STD-202	95 % coverage	-	-

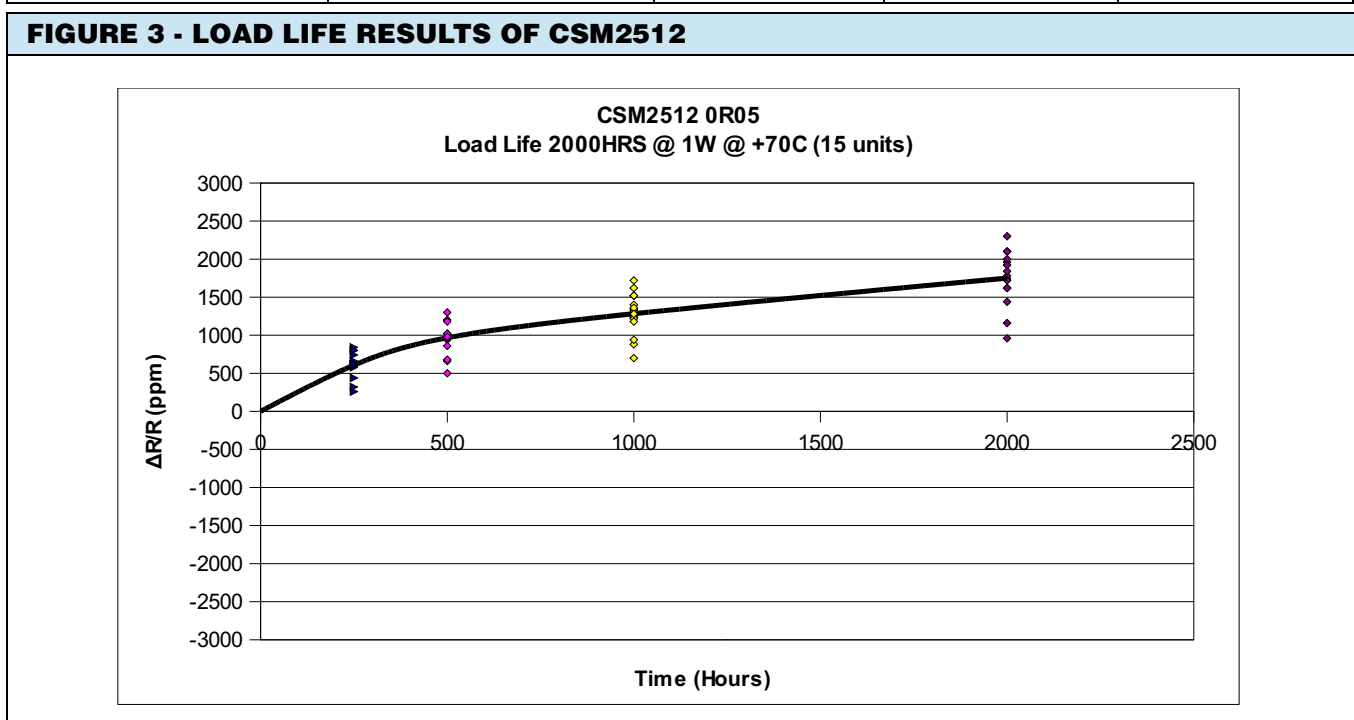

FIGURE 4 - THERMAL SHOCK RESULTS OF CSM3637 AND CSM2512

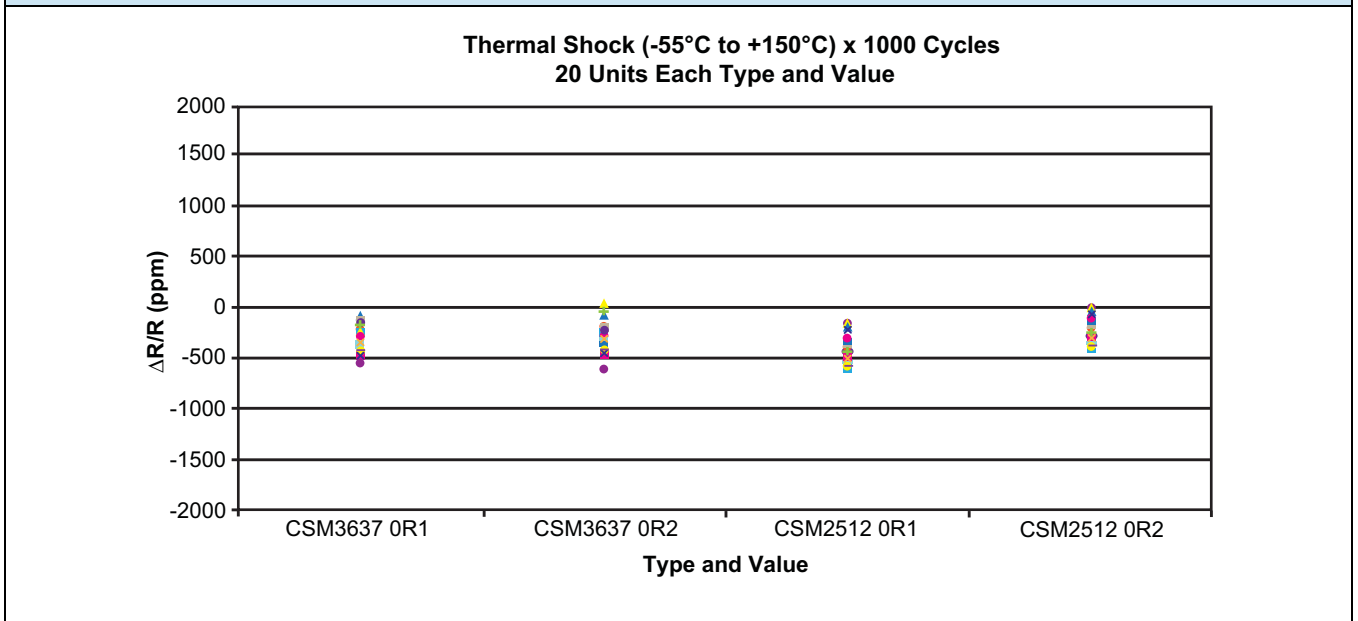

FIGURE 5 - BIAS HUMIDITY RESULTS OF CSM3637 AND CSM2512

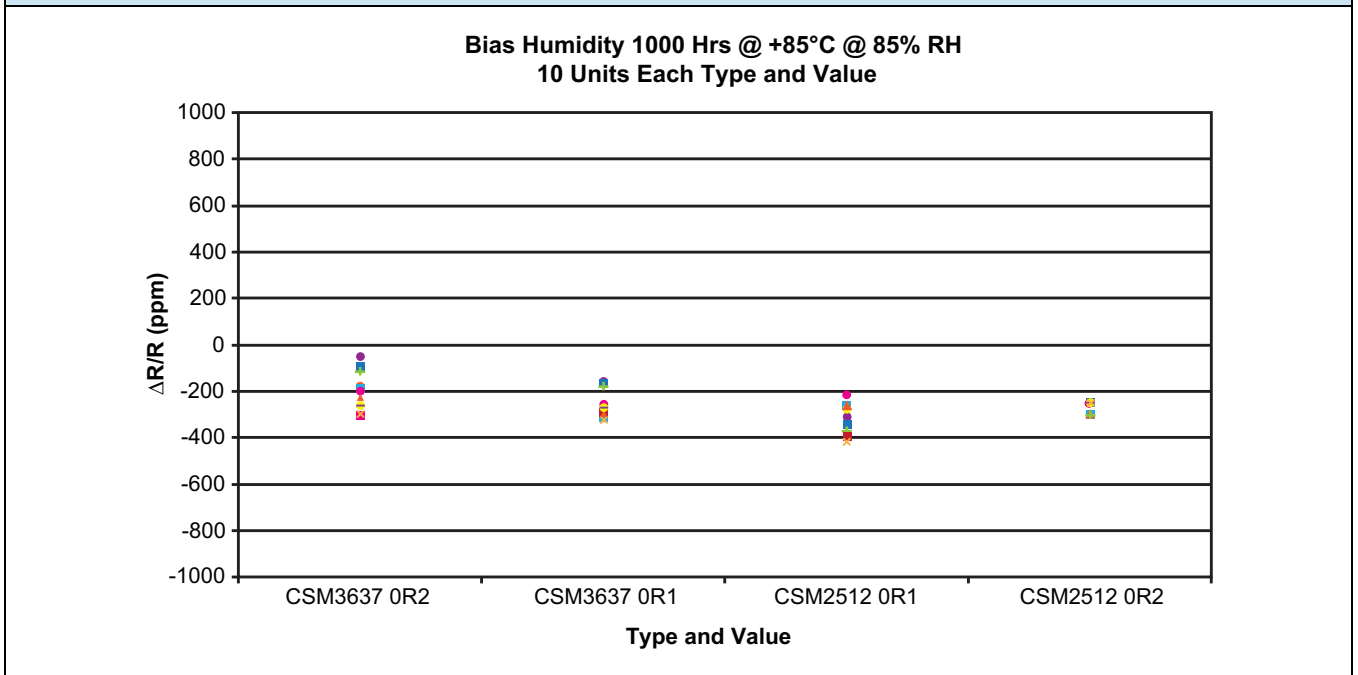

FIGURE 6 - PULSE TEST I

CSM3637 0R005 Test - 10 units
(5 Pulses of 5 sec @ 30 A, 10 sec @ 0 A)

Average Resistance Deviation: 696 ppm
STD = 305 ppm, Measurement Error = 0.0005R

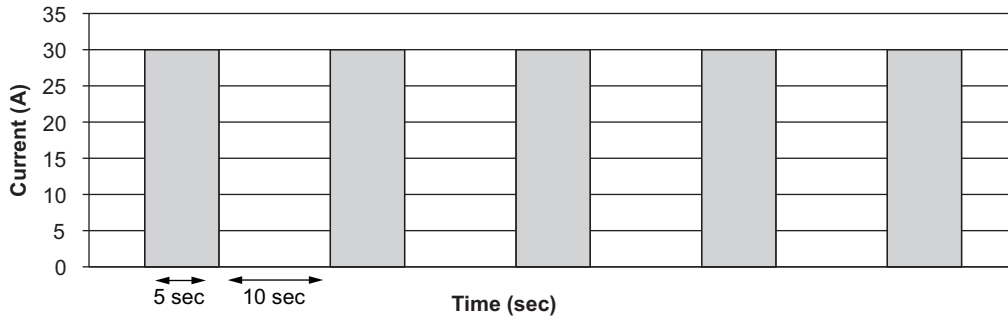

FIGURE 7 - PULSE TEST II

CSM3637 0R005 Pulse Test - 10 units
(35 Pulses of 0.2 msec @ 20 A, 0.5 msec @ 3 A)

Average Resistance Deviation: 13.3 ppm
STD = 27.3 ppm, Measurement Error = 0.0005R

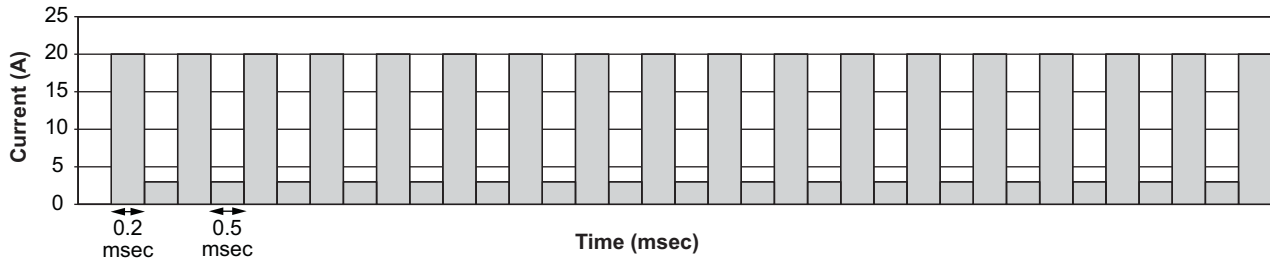
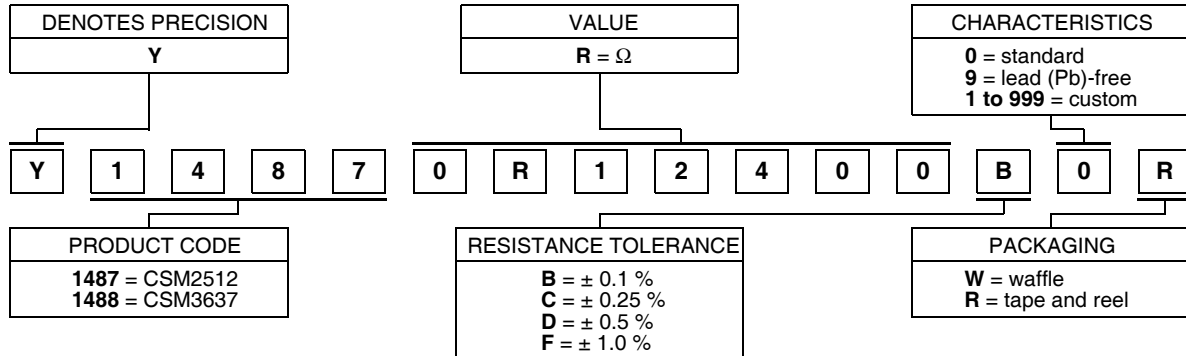

TABLE 3 - GLOBAL PART NUMBER INFORMATION (1)

NEW GLOBAL PART NUMBER: Y14870R12400B0R (preferred part number format)



FOR EXAMPLE: ABOVE GLOBAL ORDER Y1487 0R12400 B 0 R:

TYPE: CSM2512
 VALUE: 124.0 mΩ
 ABSOLUTE TOLERANCE: ± 0.1 %
 TERMINATION: standard tin/lead
 PACKAGING: tape and reel

HISTORICAL PART NUMBER: CSM2512 0R1240 B B T (will continue to be used)

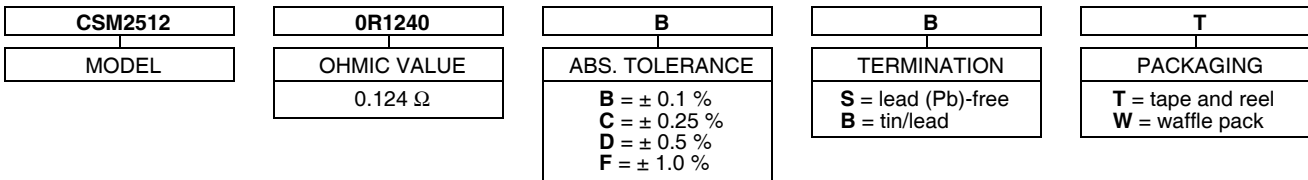

Note

(1) For non-standard requests, please contact application engineering



Disclaimer

ALL PRODUCTS, PRODUCT SPECIFICATIONS AND DATA ARE SUBJECT TO CHANGE WITHOUT NOTICE.

Vishay Precision Group, Inc., its affiliates, agents, and employees, and all persons acting on its or their behalf (collectively, "VPG"), disclaim any and all liability for any errors, inaccuracies or incompleteness contained herein or in any other disclosure relating to any product.

The product specifications do not expand or otherwise modify VPG's terms and conditions of purchase, including but not limited to, the warranty expressed therein.

VPG makes no warranty, representation or guarantee other than as set forth in the terms and conditions of purchase. **To the maximum extent permitted by applicable law, VPG disclaims (i) any and all liability arising out of the application or use of any product, (ii) any and all liability, including without limitation special, consequential or incidental damages, and (iii) any and all implied warranties, including warranties of fitness for particular purpose, non-infringement and merchantability.**

Information provided in datasheets and/or specifications may vary from actual results in different applications and performance may vary over time. Statements regarding the suitability of products for certain types of applications are based on VPG's knowledge of typical requirements that are often placed on VPG products. It is the customer's responsibility to validate that a particular product with the properties described in the product specification is suitable for use in a particular application. You should ensure you have the current version of the relevant information by contacting VPG prior to performing installation or use of the product, such as on our website at vpgsensors.com.

No license, express, implied, or otherwise, to any intellectual property rights is granted by this document, or by any conduct of VPG.

The products shown herein are not designed for use in life-saving or life-sustaining applications unless otherwise expressly indicated. Customers using or selling VPG products not expressly indicated for use in such applications do so entirely at their own risk and agree to fully indemnify VPG for any damages arising or resulting from such use or sale. Please contact authorized VPG personnel to obtain written terms and conditions regarding products designed for such applications.

Product names and markings noted herein may be trademarks of their respective owners.

Copyright Vishay Precision Group, Inc., 2014. All rights reserved.

X-ON Electronics

Largest Supplier of Electrical and Electronic Components

Click to view similar products for [vishay](#) manufacturer:

Other Similar products are found below :

[M39006/22-0577H](#) [Y00892K49000BR13L](#) [VS-12CWQ10FNPBF](#) [M8340109M6801GGD03](#) [VS-MBRB1545CTPBF](#) [1KAB100E](#)
[CRCW1210360RFKEA](#) [VSMF4720-GS08](#) [CRCW04024021FRT7](#) [001789X](#) [LTO050FR0500JTE3](#) [CRCW0805348RFKEA](#)
[LVR10R0200FE03](#) [CRCW12063K30FKEAHP](#) [009923A](#) [CRCW2010331JR02](#) [CRCW25128K06FKEG](#) [CS6600552K000B8768](#) [M39003/01-2289](#) [M39003/01-2784](#) [M39006/25-0133](#) [M39006/25-0228](#) [M64W101KB40](#) [M64Z501KB40](#) [CW001R5000JS73](#) [CW0055R000JE12](#)
[CW0056K800JB12](#) [CW0106K000JE73](#) [672D826H075EK5C](#) [CWR06JC105KC](#) [CWR06NC475JC](#) [MAL219699001E3](#)
[MCRL007035R00JHB00](#) [PTF56100K00QYEK](#) [PTN0805H1502BBTR1K](#) [RCL12252K20JNEG](#) [RCWL1210R130JNEA](#) [RH005220R0FE02](#)
[RH005330R0FC02](#) [RH010R0500FC02](#) [132B20103](#) [RH1007R000FJ01](#) [RH2503R500FE01](#) [RH254R220FS03](#) [RH-50-40R2-1%-C02](#)
[134D336X9075C6](#) [132B00301](#) [135D277X0025F6](#) [DG202BDY-T1-E3](#) [DG9426EDQ-T1-GE3](#)