

1

2

3

4

5

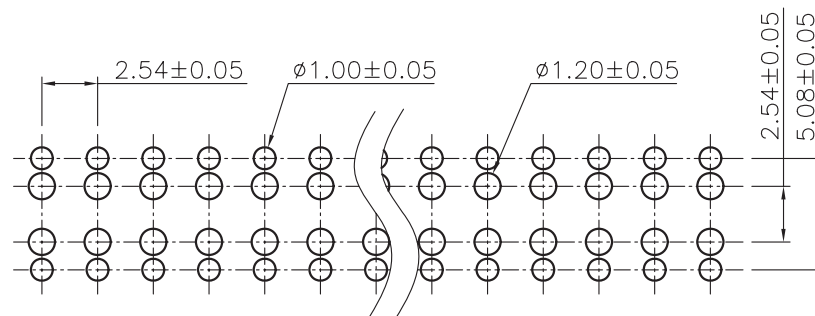

PCB LAYOUT - COMPONENT VIEW

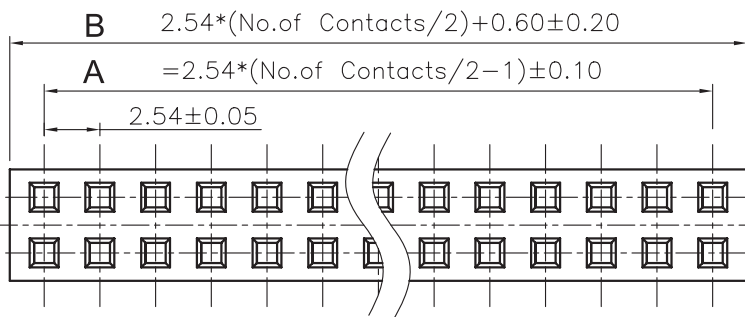
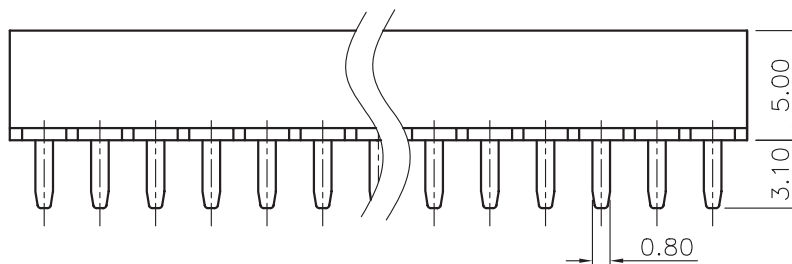
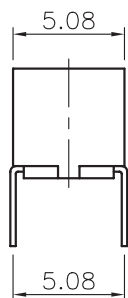

TECHNICAL CHARACTERISTICS

MATERIAL

INSULATOR: PA 46
 COLOR: BLACK
 FLAMMABILITY RATING: UL94-V0
 CONTACT MATERIAL: COPPER ALLOY
 CONTACT TYPE: STAMPED
 CONTACT PLATING: GOLD
 QUALITY CLASS: 3 AS PER CECC 75 301-802
 PITCH: 2.54MM

ENVIRONMENTAL

OPERATING TEMPERATURE: -40°C UP TO 125°C
 COMPLIANCE: LEAD FREE AND ROHS

ELECTRICAL

CURRENT RATING: 3A
 WORKING VOLTAGE: 250 VAC
 INSULATOR RESISTANCE: >1000 MΩ
 DIELECTRIC WITHSTANDING VOLTAGE: 500 VAC/MIN
 CONTACT RESISTANCE: 20 mΩ MAX

SOLDERING

JEDEC LEAD FREE WAVE SOLDERING

PACKAGING

TUBE

DIMENSION

A = 2.54 x ((NB. PIN / 2) - 1)
 B = 2.54 x (NB. PIN / 2) + 0.60

RoHS Compliant

PROJECTION:



GENERAL TOLERANCE

.X = ± 0.2 .XX = ± 0.15 

APPROVAL: GM

UNIT: MM

SCALE:

SHEET: 1/3

DRAW: AS

DESCRIPTION: 2.54MM DUAL SOCKET HEADER BOTTOM ENTRY - WR-PHD

SIZE

A4

H	04-11-14	GENERAL UPDATE	AS
REV	DATE	FILE	BY

WERI PART NO: 6130 xx 257 21

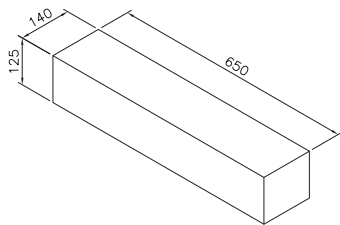
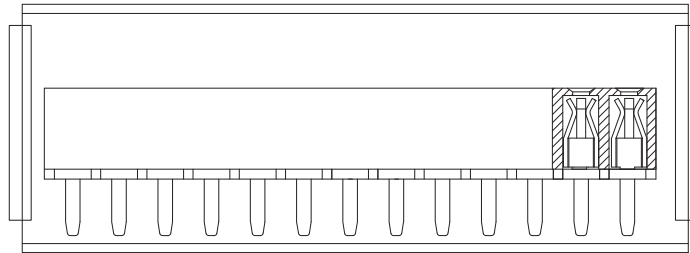
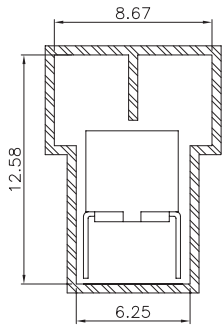
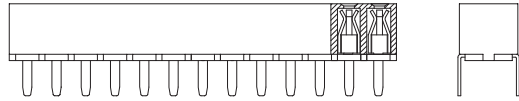
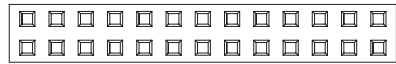

INNER CARTON

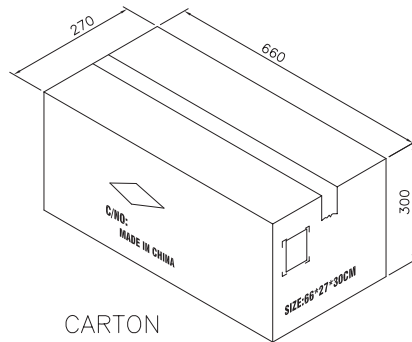

CARTON

Note:

1.Dimension

Tube Size:635(L) (mm)

Inner Carton Size:650(L)X140(W)X125(H) (mm)

Carton Size:660(L)X270(W)X300(H) (mm)

2.Quantity:

90 Tube/Inner Carton

4 Inner Carton/Carton

Pin	Pcs/Tube	Pcs/Inner Carton	Pcs/Carton	Pin	Pcs/Tube	Pcs/Inner Carton	Pcs/Carton
4	108	9720	38880	44	10	900	3600
6	74	6660	26640	46	10	900	3600
8	57	5130	20520	48	9	810	3240
10	46	4140	16560	50	9	810	3240
12	38	3420	13680	52	9	810	3240
14	33	2970	11880	54	8	720	2880
16	29	2610	10440	56	8	720	2880
18	26	2340	9360	58	8	720	2880
20	23	2070	8280	60	8	720	2880
22	21	1890	7560	62	7	630	2520
24	19	1710	6840	64	7	630	2520
26	18	1620	6480	66	7	630	2520
28	17	1530	6120	68	7	630	2520
30	15	1350	5400	70	6	540	2160
32	14	1260	5040	72	6	540	2160
34	14	1260	5040	74	6	540	2160
36	13	1170	4680	76	6	540	2160
38	12	1080	4320	78	6	540	2160
40	11	990	3960	80	6	540	2160
42	11	990	3960				

RoHS Compliant

G			
F			
E			
D			
C			
B			
A			
REV	DATE	FILE	BY

PROJECTION:
APPROVAL: GM

GENERAL TOLERANCE
.X = +/- 0.2
.XX = +/- 0.15
UNIT: MM
SCALE:
SHEET: 2/3
DRAW: AS

DESCRIPTION: 2.54MM DUAL SOCKET HEADER BOTTOM ENTRY - WR-PHD

WERI PART NO: 6130 xx 257 21_TPK

SIZE
A4

1

2

3

4

5

Cautions and Warnings:

This electronic component is designed and developed with the intention for use in general electronics equipments.

Before incorporating the components into any equipments in the field such as aerospace, aviation, nuclear control, submarine, transportation, (automotive control, train control, ship control), transportation signal, disaster prevention, medical, public information network etc. where higher safety and reliability are especially required or if there is possibility of direct damage or injury to human body, Würth Elektronik must be asked for a written approval.



In addition, even electronic component in general electronic equipments, when used in electrical circuits that require high safety, reliability functions or performance, the sufficient reliability evaluation-check for the safety must be performed before by the user before usage.

A

B

C

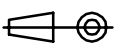
RoHS Compliant

G				PROJECTION: 	GENERAL TOLERANCE .X = +/- 0.2 .XX = +/- 0.15		
F							
E							
D							
C				APPROVAL: JC	UNIT: MM	DESCRIPTION: DISCLAIMER	SIZE A4
B					SCALE:		
A	10-SEP-14	PDF	QL		SHEET: 3/3	WERI PART NO: DISCLAIMER	
REV	DATE	FILE	BY		DRAW: QL		

D

X-ON Electronics

Largest Supplier of Electrical and Electronic Components

Click to view similar products for [wurth manufacturer](#):

Other Similar products are found below :

[687001](#) [742700](#) [74270062](#) [74437349220](#) [744741101](#) [750314624](#) [750341638](#) [31402](#) [686626050001](#) [744741471](#) [744772681](#) [744777](#)
[749119950](#) [750312504](#) [890334025009](#) [IC-744885](#) [875115350002](#) [865230143004](#) [860160275030](#) [600690282801](#) [178050601](#) [615008138221](#)
[750311898](#) [744999](#) [7446823003](#) [7446323004](#) [744028](#) [66201621822](#) [7446221012](#) [744720](#) [760895431](#) [760895651](#) [662006236022](#)
[64900621822](#) [418117270910](#) [890334026014](#) [744839208072](#) [744762A/RFI](#) [74651174R](#) [744838180160](#) [750310346](#) [861011384014](#)
[750817018](#) [3020903](#) [885342](#) [2603019321001](#) [2603019021001](#) [2606039021001](#) [2608019324001](#) [2607019213001](#)