

1

2

3

4

5

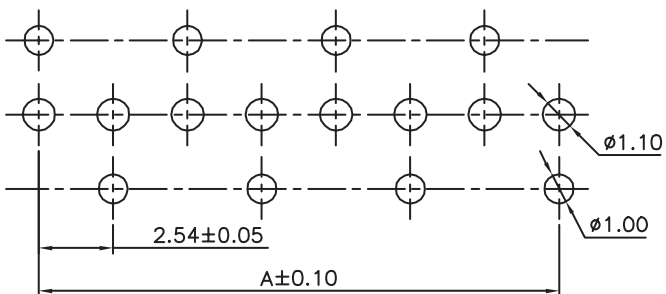

PCB LAYOUT - COMPONENT VIEW

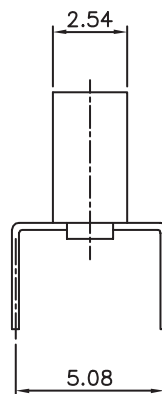
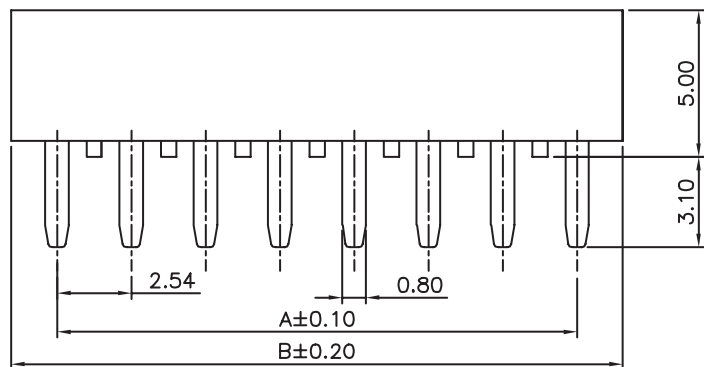
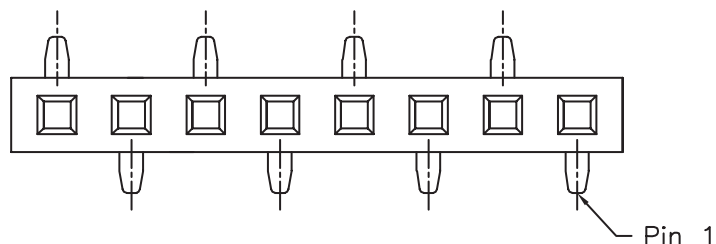

TECHNICAL CHARACTERISTICS

MATERIAL
 INSULATOR: PA 46
 FLAMABILITY RATING: UL94-V0
 MAX TEMPERATURE: WAVE SOLDERING COMPATIBLE
 COLOR: BLACK
 CONTACT MATERIAL: COPPER ALLOY
 CONTACT TYPE: STAMPED
 CONTACT PLATING: GOLD
 QUALITY CLASS: 3 AS PER IEC 60 603-13
 PITCH: 2.54MM

ENVIRONMENTAL
 OPERATING TEMPERATURE: -40 UP TO 125°C
 COMPLIANCE: LEAD FREE AND ROHS

ELECTRICAL
 CURRENT RATING: 3 A
 WORKING VOLTAGE: 250 VAC
 INSULATOR RESISTANCE: >1000 MOHM
 DIELECTRIC WITHSTANDING VOLTAGE: 500 VAC/MN
 CONTACT RESISTANCE: 20 mOHM MAX

STANDARD
 CERTIFIED: E323964

SOLDERING
 JEDEC LEAD FREE WAVE SOLDERING PROCESS

PACKAGING
 TUBE

DIMENSION
 A = 2.54x (NB. PIN - 1)
 B = 2.54x NB. PIN + 0.5

RoHS Compliant

PROJECTION:



GENERAL TOLERANCE

.X = ± 0.2 .XX = ± 0.15 

APPROVAL: GMo

UNIT: MM

SCALE:

SHEET: 1/3

DRAW: PEARL

DESCRIPTION: 2.54MM SOCKET HEADER BOTTOM ENTRY

WERI PART NO: 613 0xx 157 21

SIZE

A4

REV	DATE	FILE	BY
H	19-FEB-14	SOLDERING	QL
I	21-JUN-16	TPK	AK

1

2

3

4

5

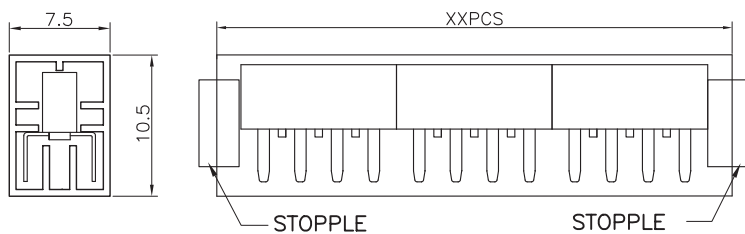

Note

1.Dimension:

Tube Size:635(L)X7.5(W)X10.5(H) (MM)

Carton Size:650(L)X125(W)X140(H) (MM)

2.Quantity:

180 Tube/Carton

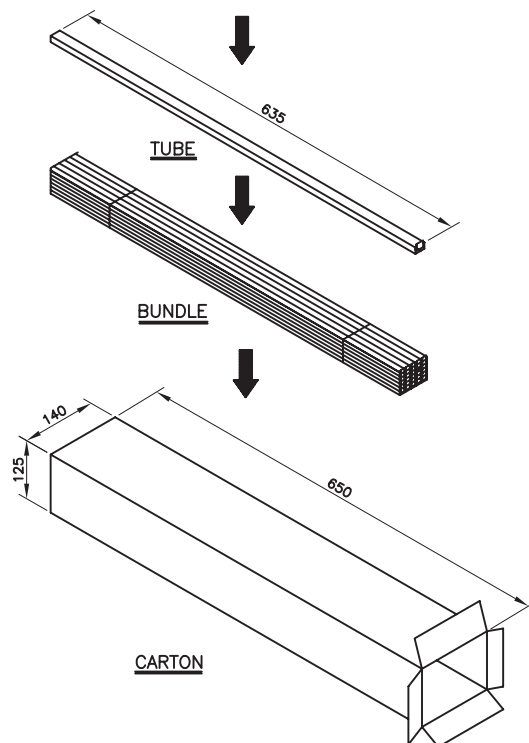

Pin	Pcs/Tube	Pcs/Carton	Pin	Pcs/Tube	Pcs/Carton
2	110	19800	22	10	1800
3	75	13500	23	10	1800
4	57	10260	24	10	1800
5	46	8280	25	9	1620
6	39	7020	26	9	1620
7	33	5940	27	8	1440
8	29	5220	28	8	1440
9	26	4680	29	8	1440
10	23	4140	30	8	1440
11	21	3780	31	7	1260
12	19	3420	32	7	1260
13	18	3240	33	7	1260
14	17	3060	34	7	1260
15	15	2700	35	6	1080
16	14	2520	36	6	1080
17	14	2520	37	6	1080
18	13	2340	38	6	1080
19	12	2160	39	6	1080
20	12	2160	40	6	1080
21	11	1980			

RoHS Compliant

PROJECTION:



GENERAL TOLERANCE

.X = +/- 0.2

.XX = +/- 0.15



APPROVAL: GMo

UNIT: MM

SCALE:

SHEET: 2/3

DRAW: PEARL

DESCRIPTION: 2.54MM SOCKET HEADER BOTTOM ENTRY

WERI PART NO: 613 0xx 157 21

SIZE

A4

G			
F			
E			
D			
C			
B			
A			
REV	DATE	FILE	BY

1

2

3

4

5

Cautions and Warnings:

This electronic component is designed and developed with the intention for use in general electronics equipments.

Before incorporating the components into any equipments in the field such as aerospace, aviation, nuclear control, submarine, transportation, (automotive control, train control, ship control), transportation signal, disaster prevention, medical, public information network etc. where higher safety and reliability are especially required or if there is possibility of direct damage or injury to human body, Würth Elektronik must be asked for a written approval.



In addition, even electronic component in general electronic equipments, when used in electrical circuits that require high safety, reliability functions or performance, the sufficient reliability evaluation-check for the safety must be performed before by the user before usage.

A

B

C

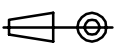
RoHS Compliant

G				PROJECTION: 	GENERAL TOLERANCE .X = +/- 0.2 .XX = +/- 0.15		
F							
E							
D							
C				APPROVAL: JC	UNIT: MM	DESCRIPTION: DISCLAIMER	SIZE A4
B					SCALE:		
A	10-SEP-14	PDF	QL		SHEET: 3/3	WERI PART NO: DISCLAIMER	
REV	DATE	FILE	BY		DRAW: QL		

D

X-ON Electronics

Largest Supplier of Electrical and Electronic Components

Click to view similar products for [wurth manufacturer](#):

Other Similar products are found below :

[687001](#) [742700](#) [74270062](#) [74437349220](#) [744741101](#) [750314624](#) [750341638](#) [31402](#) [686626050001](#) [744741471](#) [744772681](#) [744777](#)
[749119950](#) [750312504](#) [890334025009](#) [IC-744885](#) [875115350002](#) [865230143004](#) [860160275030](#) [600690282801](#) [178050601](#) [615008138221](#)
[750311898](#) [744999](#) [7446823003](#) [7446323004](#) [744028](#) [66201621822](#) [7446221012](#) [744720](#) [760895431](#) [760895651](#) [662006236022](#)
[64900621822](#) [418117270910](#) [890334026014](#) [744839208072](#) [744762A/RFI](#) [74651174R](#) [744838180160](#) [750310346](#) [861011384014](#)
[750817018](#) [3020903](#) [885342](#) [2603019321001](#) [2603019021001](#) [2606039021001](#) [2608019324001](#) [2607019213001](#)