

1

2

3

4

5

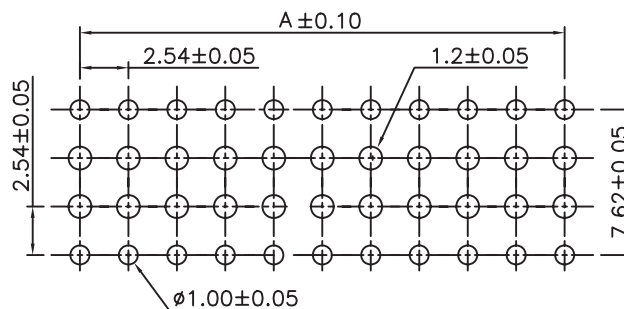

PCB LAYOUT - COMPONENT VIEW

TECHNICAL CHARACTERISTICS

MATERIAL
 INSULATOR: PA 46
 FLAMABILITY RATING: UL94-V0
 COLOR: BLACK
 CONTACT MATERIAL: COPPER ALLOY
 CONTACT TYPE: STAMPED
 CONTACT PLATING: GOLD
 QUALITY CLASS: 3 AS PER CECC 75 301-802
 PITCH: 2.54MM

ENVIRONMENTAL
 OPERATING TEMPERATURE: -40 UP TO 125°C
 COMPLIANCE: LEAD FREE AND ROHS

ELECTRICAL
 CURRENT RATING: 3 A
 WORKING VOLTAGE: 250 VAC
 INSULATOR RESISTANCE: >1000 MOHM
 DIELECTRIC WITHSTANDING VOLTAGE: 500 VAC/MN
 CONTACT RESISTANCE: 20 mOHM MAX

STANDARD
 CERTIFIED: E323964

SOLDERING
 JEDEC LEAD FREE WAVE SOLDERING PROCESS

PACKAGING
 TUBE

DIMENSION
 A = 2.54 x (NB. PIN / 2 - 1)
 B = 2.54 x (NB. PIN / 2) + 0.50

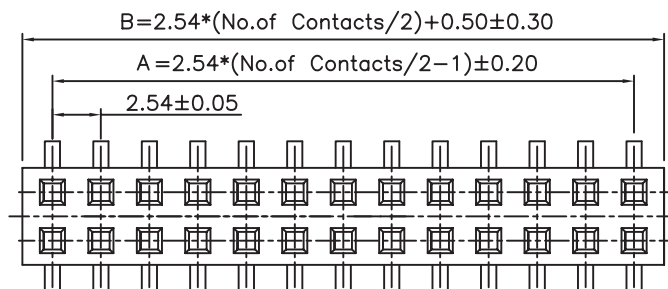
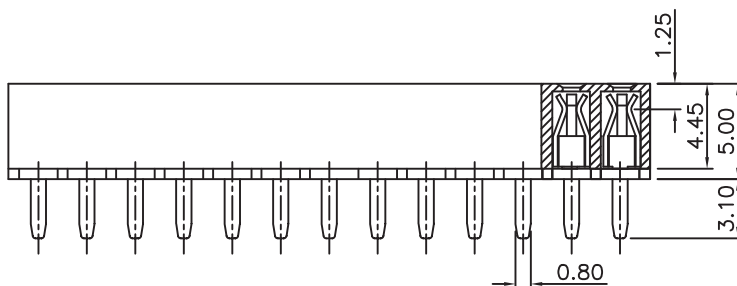
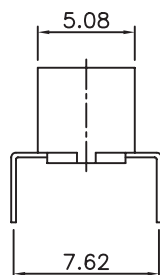

RoHS Compliant

PROJECTION:



GENERAL TOLERANCE

.X = +/- 0.2

.XX = +/- 0.15



APPROVAL: GMo

UNIT: MM

SCALE:

SHEET: 1/3

DRAW: PEARL

DESCRIPTION: 2.54MM DUAL S. HEADER BOTTOM ENTRY LARGE

WERI PART NO: 613 0xx 216 921

SIZE

A4

J			
I			
H	17-JUN-16	TPK	AK
REV	DATE	FILE	BY

1

2

3

4

5

NOTE:

1.DIMESION

TUBE SIZE:635(L)X9.67(W)X13.58(H) (MM)

CARTON SIZE:650(L)X140(W)X125(H) (MM)

2.QUANTITY:

140 TUBE/CARTON

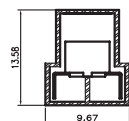

Section:A-A

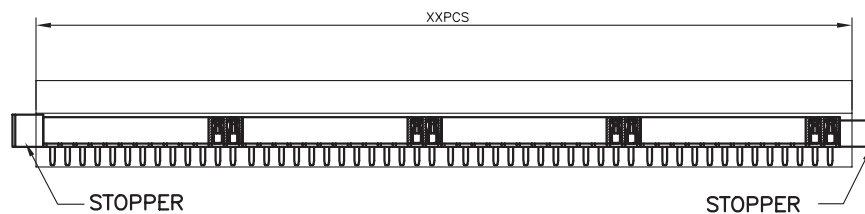

TUBE LAYOUT

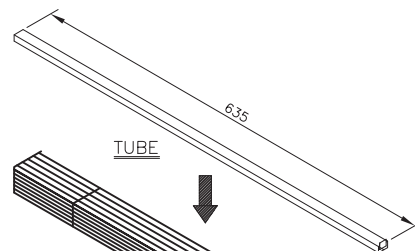

TUBE

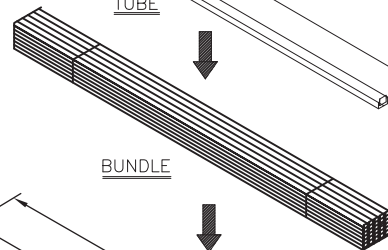

BUNDLE

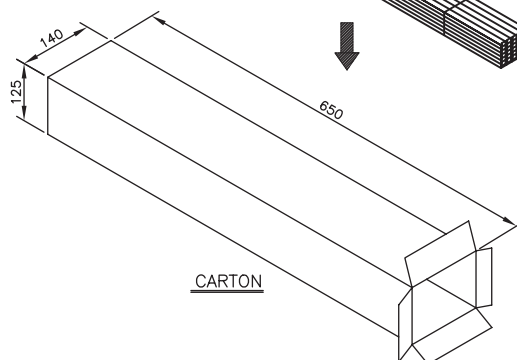

CARTON

Pin.	Pcs/Tube	Tube/Carton	Pcs/Carton
4	108	140	15120
6	74	140	10360
8	57	140	7980
10	46	140	6440
12	38	140	5320
14	33	140	4620
16	29	140	4060
18	26	140	3640
20	23	140	3220
22	21	140	2940
24	19	140	2660
26	18	140	2520
28	17	140	2380
30	15	140	2100
32	14	140	1960
34	14	140	1960
36	13	140	1820
38	12	140	1680
40	11	140	1540
42	11	140	1540
44	10	140	1400
46	10	140	1400
48	9	140	1260
50	9	140	1260
52	9	140	1260
54	8	140	1120
56	8	140	1120
58	8	140	1120
60	8	140	1120
62	7	140	980
64	7	140	980
66	7	140	980
68	7	140	980
70	6	140	840
72	6	140	840
74	6	140	840
76	6	140	840
78	6	140	840
80	6	140	840

RoHS Compliant

PROJECTION:



GENERAL TOLERANCE

.X = \pm 0.2.XX = \pm 0.15

APPROVAL: GMo

UNIT: MM

DESCRIPTION: 2.54MM DUAL S. HEADER BOTTOM ENTRY LARGE

SIZE

SCALE:

A4

SHEET: 2/3

WERI PART NO: 613 0xx 216 921

DRAW: PEARL

A

B

C

D

1

2

3

4

5

Cautions and Warnings:

This electronic component is designed and developed with the intention for use in general electronics equipments.

Before incorporating the components into any equipments in the field such as aerospace, aviation, nuclear control, submarine, transportation, (automotive control, train control, ship control), transportation signal, disaster prevention, medical, public information network etc. where higher safety and reliability are especially required or if there is possibility of direct damage or injury to human body, Würth Elektronik must be asked for a written approval.

In addition, even electronic component in general electronic equipments, when used in electrical circuits that require high safety, reliability functions or performance, the sufficient reliability evaluation-check for the safety must be performed before by the user before usage.

A

B

C

RoHS Compliant

G				PROJECTION: 	GENERAL TOLERANCE .X = +/- 0.2 .XX = +/- 0.15		
F							
E							
D							
C				APPROVAL: JC	UNIT: MM	DESCRIPTION: DISCLAIMER	SIZE A4
B					SCALE:		
A	10-SEP-14	PDF	QL		SHEET: 3/3	WERI PART NO: DISCLAIMER	
REV	DATE	FILE	BY		DRAW: QL		

D

X-ON Electronics

Largest Supplier of Electrical and Electronic Components

Click to view similar products for [wurth manufacturer](#):

Other Similar products are found below :

[687001](#) [742700](#) [74270062](#) [74437349220](#) [744741101](#) [750314624](#) [750341638](#) [31402](#) [686626050001](#) [744741471](#) [744772681](#) [744777](#)
[749119950](#) [750312504](#) [890334025009](#) [IC-744885](#) [875115350002](#) [865230143004](#) [860160275030](#) [600690282801](#) [178050601](#) [615008138221](#)
[750311898](#) [744999](#) [7446823003](#) [7446323004](#) [744028](#) [66201621822](#) [7446221012](#) [744720](#) [760895431](#) [760895651](#) [662006236022](#)
[64900621822](#) [418117270910](#) [890334026014](#) [744839208072](#) [744762A/RFI](#) [74651174R](#) [744838180160](#) [750310346](#) [861011384014](#)
[750817018](#) [3020903](#) [885342](#) [2603019321001](#) [2603019021001](#) [2606039021001](#) [2608019324001](#) [2607019213001](#)