

Wera ratchets

We simply could not believe that it was not possible to improve on existing standards for ratchets.

We took up the challenges confronting users when working with ratchets. Mostly, it is a question of working speed, confined working space and diverse functionality.

We did a lot of research, until we finally came up with suitable problem solutions that we can offer across the entire range.



The Zyklop Speed Ratchet

The Wera Zyklop Speed ratchet combines the advantages of five different types of ratchet in one. And it is a really fast mover.

The Zyklop Hybrid Ratchet

Combines robustness, slim design, and little weight.

The Zyklop Ratchet Metal Push

Extremely slim. Long leverage. With push-through square.



The Zyklop Ratchet Metal Switch

Extremely slim. Long leverage. With switch lever.



The Koloss Ratchet

The heavy-duty ratchet that can also be safely used as a hammer.



The Zyklop Mini Ratchets

For all difficult-to-access applications.

Zyklop Speed ratchet

We just could not believe that it was not possible to make a ratchet work more quickly. Moreover, we did not like the way users had to apply many different types of ratchet to get a job done. We therefore questioned everything that was conventional about ratchets. The Zyklop Speed ratchet is what has emerged. The flywheel design of the Zyklop Speed ensures high working speeds. And: the Zyklop Speed combines the advantages of 5 types of ratchet in a single tool. Additionally, it can be used as a screwdriver.



The ratchet head pivots freely and can be locked into any position by using the slide switch that is positioned on either side. It is even possible to work in very confined and difficult-to-access areas with enhanced hand clearance. The pre-defined locking at 0°, 15° and 90°, both to the right and left, ensure safe working without any slipping of the ratchet head.

The Zyklop Speed ratchets are really fast movers. The gyrating mass design means that screwdriving is accelerated. The rotation-symmetric structure of the Kraftform handle and the free-turning sleeve reinforce this rapid twisting process, particularly when the ratchet does not engage due to too little resistance in the thread.



The outstanding design of the Kraftform handle fits perfectly into the hand, preventing hand injuries such as blisters and calluses. The hard materials used for the handle ensure quick and easy hand repositioning without any danger of the skin “sticking” to the handle, whilst the softer “anti-slip” zones enable the low-loss transfer of high forces – resulting in less screwdriving effort being required. The circular handle design allows rapid turning in the 0° position.



All Zyklop Speed ratchets feature a thumbwheel that can be used to quickly and easily switch between clockwise and anticlockwise rotation, at any position. No complicated handling, no loss of time!

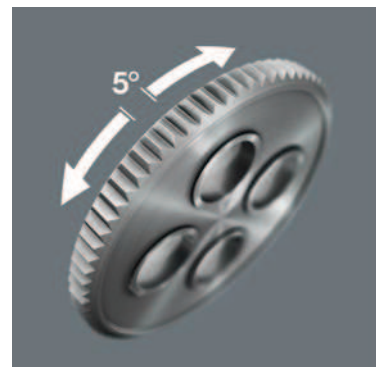

The reversible ratchet with 72 fine-pitched teeth has a low return angle of only 5°. This short stroke allows fast and precise work in all types of installation.



The ball lock holds the sockets and attachments securely, ensuring safe working. A changeover into any predefined position is completed by simply pressing the release button – this is even the case in the 90° position.



The ratchet head has an ergonomic design with finger recesses that offer a perfect contact surface for the hand or fingers to turn the head.



The ratchet can be used as a conventional screwdriver in the 0° position by attaching a bitholding adaptor and a bit.

Zyklop Hybrid ratchet

We wanted to integrate all the mostly-desired ratchet advantages in a single tool. Our idea was to develop a light ratchet with an ergonomic handle, slim design, long lever and an extension option.

Since the term “hybrid” refers to a combination from various sectors, it was quite easy to decide on the name.



The reversible ratchet with 72 finepitched teeth has a low return angle of only 5°. This short stroke allows fast and precise work in all types of installation.



The ball lock holds the sockets and attachments securely, ensuring safe working.



Multi-component Kraftform handle for optimum pressure and tensile loads.



Very slim ratchet head.



Larger overall length for higher torque transfer.

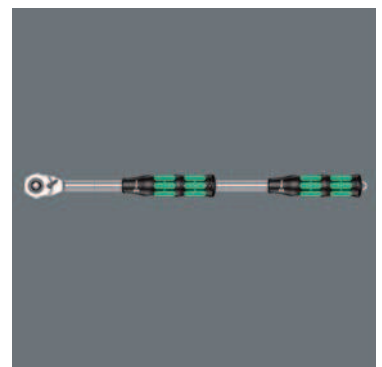

Even more torque can be applied by using the extension.



Zyklop Metal ratchet

Due to the ever-more confined working environment, space is becoming more and more an issue for the application of ratchets. Our product developers therefore intensively occupied themselves with the issue of confined working spaces, and Wera has now solved this problem.

The extremely slim and robust Zyklop Metal ratchet with a long lever was what emerged. When the change in direction needs to be quick, the Zyklop Metal Switch ratchet is the right tool.

When the socket must not get lost and a coincidental change of direction has to be avoided at all cost, the Zyklop Metal Push is the correct choice.



Forged, full metal ratchet (chrome-molybdenum) that is extremely robust with a long service life; slim design to enable work in very confined spaces.



Zyklop Metal Push

Smooth push-through mechanism, that cannot get lost.



Zyklop Metal Push

The dual-ratchet-teeth design means that a 76 fine-toothing division can be achieved from the 38 robust teeth with a return angle of only 4.7°.

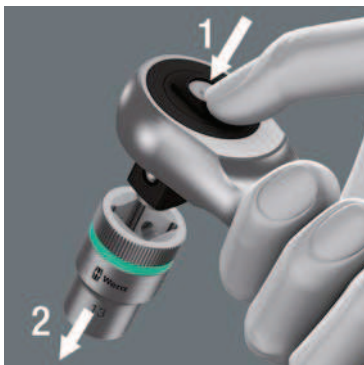

The ball lock holds the sockets and attachments securely, ensuring safe working.



Zyklop Metal Switch
Switch lever for convenient change of direction.



Zyklop Metal Switch
Fine-tooth mechanism with 72 teeth for a return angle of only 5°. This short stroke allows fast and precise work in all types of installation.

Zyklop Accessories

We did not just want our creativity to end with the ratchets themselves so we also occupied ourselves intensively with ratchet accessories. That is why our users are now provided with an extension with freely spinning sleeve and flexible lock to enable more secure and more rapid screwdriving.

The sockets have been completely redesigned: we wanted to spare the user the need of having two different series – one for manual and the other for power tool applications.

And: we wanted to enormously simplify the task of finding the right sizes. Technically, our own ambitious goals represented a real challenge: to endow sockets with the advantage of the holding function on screwdrivers and bits. We succeeded in this!

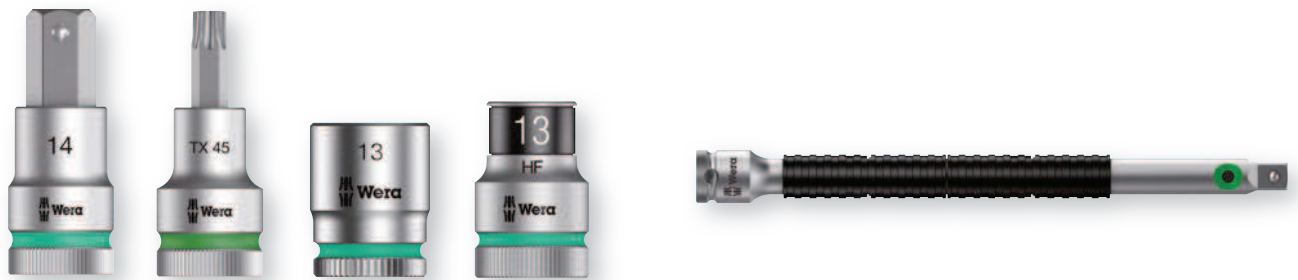

"Take it easy" tool finder system - with profile and size colour-coding for quick and easy tool selection. Colour-coded system for hexagon drive screws (L-Keys, Zyklop bit sockets), external hex drive screws and nuts (Joker wrenches, Zyklop sockets and Zyklop bit sockets with holding function), and TORX® drive screws (L-Keys, Zyklop bit sockets).



The manual and machine sockets can be used both for hand and power tools use (non-impact). Users need just one socket set for all applications.



Zyklop sockets and bit sockets with holding function securely hold the screw on the tool. This is particularly helpful in difficult-to-access working spaces where the second hand cannot be used to hold the screw.



The extensions from the premium lines are also equipped with the unique “flexible-lock-system”. By activating this system, attachments can be fixed to the extension permanently – preventing slipping and any unintentional loss of the attachment. When the system is deactivated, the sockets can be attached as usual and changed in a flash.



The freely spinning sleeve on the Zyklop Speed and the Zyklop extension effectively accelerates the turning of screws and nuts.



Zyklop Ratchets, 1/4"



Zyklop Speed

130



Zyklop Metal Push

136



Zyklop Metal Switch

138



Zyklop Accessories

140



The Zyklop Speed Ratchets, 1/4"

Combine 5 types of ratchet

8100 SA 6 Zyklop Speed Ratchet Set, 1/4" drive, metric

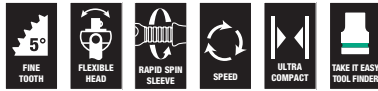

28-piece set; in a surface-preserving, compact and extremely robust textile box; low volume and weight for simplified mobility

1 Zyklop Speed Ratchet with 1/4" drive, 9 Zyklop sockets, 1 Zyklop extension (long) with free-turning sleeve, 1 wobble extension, 1 adaptor with quick-release chuck, 15 bits

05004016001		
○	8000 A	1 x 1/4"x152,0
●	8790 HMA	1 x 5,0x23,0; 1 x 5,5x23,0; 1 x 6,0x23,0; 1 x 7,0x23,0; 1 x 8,0x23,0; 1 x 10,0x23,0; 1 x 11,0x23,0; 1 x 12,0x23,0; 1 x 13,0x23,0
○	8794 LA	1 x 1/4"x150,0
○	8794 A	1 x 1/4"x56,0
○	8784 A1	1 x 1/4"x1/4"x37,0
+	851/4 TZ PH	1 x PH 1x50; 1 x PH 2x50; 1 x PH 3x50
+	855/4 TZ PZ	1 x PZ 1x50; 1 x PZ 2x50
+	867/4 Z TORX®	1 x TX 10x50; 1 x TX 15x50; 1 x TX 20x50; 1 x TX 25x50; 1 x TX 27x50; 1 x TX 30x50
○	840/4 Z Hex-Plus	1 x 3,0x50; 1 x 4,0x50; 1 x 5,0x50; 1 x 6,0x50

8100 SA 9 Zyklop Speed Ratchet Set, 1/4" drive, imperial



28-piece set; in a surface-preserving, compact and extremely robust textile box; low volume and weight for simplified mobility

1 Zyklop Speed Ratchet with 1/4" drive, 9 Zyklop sockets, 1 Zyklop extension (long) with free-turning sleeve, 1 wobble extension, 1 adaptor with quick-release chuck, 15 bits

05004019001		
○	8000 A	1 x 1/4"x152,0
●	8790 HMA	1 x 3/16"x23,0; 1 x 7/32"x23,0; 1 x 1/4"x23,0; 1 x 9/32"x23,0; 1 x 5/16"x23,0; 1 x 11/32"x23,0; 1 x 3/8"x23,0; 1 x 7/16"x23,0; 1 x 1/2"x23,0
○	8794 LA	1 x 1/4"x150,0
○	8794 A	1 x 1/4"x56,0
○	8784 A1	1 x 1/4"x1/4"x37,0
+	851/4 TZ PH	1 x PH 1x50; 1 x PH 2x50; 1 x PH 3x50
+	855/4 TZ PZ	1 x PZ 1x50; 1 x PZ 2x50
+	867/4 Z TORX®	1 x TX 10x50; 1 x TX 15x50; 1 x TX 20x50; 1 x TX 25x50; 1 x TX 27x50; 1 x TX 30x50
○	840/4 Z Hex-Plus	1 x 5/32"x50; 1 x 3/16"x50; 1 x 7/32"x50; 1 x 1/4"x50

Kraftform Kompakt Zyklop MS1 Metal/Speed 1/4"



8-piece set; in surface-protecting, compact textile box, highly robust; low volume and weight for simplified mobility.

1 Zyklop Speed ratchet with 1/4" drive, 1 Zyklop Metal ratchet with switch lever and 1/4" drive, 1 Zyklop extension (long) with rapid spin sleeve and "flexible-lock" system, 2 Zyklop extensions (short and long) with rapid spin sleeve, 1 adaptor with rapid change chuck, 1 wobble extension, 1 universal joint.

05135949001		
⊙	8000 A	1 x 1/4"x152,0
⊙	8004 A	1 x 1/4"x141,0
⊙	8796 LA	1 x 1/4"x150,0
⊙	8794 LA	1 x 1/4"x150,0
⊙	8794 SA	1 x 1/4"x75,0
⊙	8784 A1	1 x 1/4"x1/4"x37,0
⊙	8794 A	1 x 1/4"x56,0
⊙	8795 A	1 x 1/4"x35,5

Tip

Zyklop "6 in 1"



1. Fine-tooth ratchet
2. Flex-head ratchet
3. Angle ratchet
4. Quick-release ratchet
5. Power ratchet
6. Screwdriver

New set concept



The textile boxes offer dramatically improved portability, and are space-saving to boot! This means you can now carry the same collection of tools, in a much more compact and comfortable package.



The hassle of running back and forth for the right tools has now become a thing of the past. And the much lower weight of a set makes carrying more convenient than ever before. The textile box including the tool will even survive a fall undamaged.



"Take it easy"



"Take it easy" tool finder system – with profile and size colour-coding for quick and easy tool selection. Colour-coded system for hexagon drive screws (L-Keys, Zyklop bit sockets), external hex drive screws and nuts (Joker wrenches, Zyklop sockets and Zyklop bit sockets with holding function), and TORX® drive screws (L-Keys, Zyklop bit sockets).

The Zyklop Speed Ratchets, 1/4"

Combine 5 types of ratchet

8100 SA 2 Zyklop Speed Ratchet Set, 1/4" drive, metric



42-piece set in strong metal case

1 Zyklop ratchet with 1/4" drive, 13 Zyklop sockets (metric), 2 Zyklop "flexible-lock" extensions (short and long) with free-turning sleeve, 1 wobble extension, 1 sliding T-handle, 1 universal joint, 1 adaptor with quick-release chuck, 22 bits

05003533001		
⊙	8000 A	1 x 1/4"x152,0
⊙	8790 HMA	1 x 4,0x23,0; 1 x 4,5x23,0; 1 x 5,0x23,0; 1 x 5,5x23,0; 1 x 6,0x23,0; 1 x 7,0x23,0; 1 x 8,0x23,0; 1 x 9,0x23,0; 1 x 10,0x23,0; 1 x 11,0x23,0; 1 x 12,0x23,0; 1 x 13,0x23,0; 1 x 14,0x23,0
⊙	8789 A	1 x 1/4"x110,0
⊙	8794 A	1 x 1/4"x56,0
⊙	8795 A	1 x 1/4"x35,5
⊙	8784 A1	1 x 1/4"x1/4"x37,0
⊙	8796 SA	1 x 1/4"x75,0
⊙	8796 LA	1 x 1/4"x150,0
⊙	840/1 Z Hex-Plus	1 x 3,0x25; 1 x 4,0x25; 1 x 5,0x25; 1 x 6,0x25; 1 x 8,0x25
⊙	867/1 Z TORX® B0	1 x TX 8x25; 1 x TX 9x25; 1 x TX 10x25; 1 x TX 15x25; 1 x TX 20x25; 1 x TX 25x25; 1 x TX 30x25; 1 x TX 40x25
⊙	800/1 Z	1 x 0,6x4,5x25; 1 x 1,0x5,5x25; 1 x 1,2x8,0x25
⊕	851/1 Z PH	1 x PH 1x25; 1 x PH 2x25; 1 x PH 3x25
⊕	855/1 Z PZ	1 x PZ 1x25; 1 x PZ 2x25; 1 x PZ 3x25

8100 SA 4 Zyklop Speed Ratchet Set, 1/4" drive, imperial

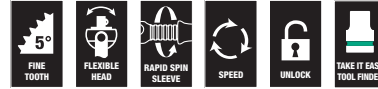

41-piece set in strong metal case

1 Zyklop ratchet with 1/4" drive, 10 Zyklop sockets (imperial), 2 Zyklop "flexible-lock" extensions (short and long) with free-turning sleeve, 1 wobble extension, 1 sliding T-handle, 1 universal joint, 1 adaptor with quick-release chuck, 24 bits

05003535001		
⊙	8000 A	1 x 1/4"x152,0
⊙	8790 HMA	1 x 3/16"x23,0; 1 x 7/32"x23,0; 1 x 1/4"x23,0; 1 x 9/32"x23,0; 1 x 5/16"x23,0; 1 x 11/32"x23,0; 1 x 3/8"x23,0; 1 x 7/16"x23,0; 1 x 1/2"x23,0; 1 x 9/16"x23,0
⊙	8789 A	1 x 1/4"x110,0
⊙	8794 A	1 x 1/4"x56,0
⊙	8795 A	1 x 1/4"x35,5
⊙	8784 A1	1 x 1/4"x1/4"x37,0
⊙	8796 SA	1 x 1/4"x75,0
⊙	8796 LA	1 x 1/4"x150,0
⊙	867/1 Z TORX® B0	1 x TX 8x25; 1 x TX 9x25; 1 x TX 10x25; 1 x TX 15x25; 1 x TX 20x25; 1 x TX 25x25; 1 x TX 30x25; 1 x TX 40x25
⊙	800/1 Z	1 x 0,6x4,5x25; 1 x 1,0x5,5x25; 1 x 1,2x8,0x25
⊕	851/1 Z PH	1 x PH 1x25; 1 x PH 2x25; 1 x PH 3x25
⊕	855/1 Z PZ	1 x PZ 1x25; 1 x PZ 2x25; 1 x PZ 3x25
⊙	840/1 Z Hex-Plus	1 x 5/64"x25; 1 x 3/32"x25; 1 x 1/8"x25; 1 x 9/64"x25; 1 x 5/32"x25; 1 x 3/16"x25; 1 x 7/32"x25

8100 SA/SC 2 Zyklop Speed Ratchet Set, 1/4" drive and 1/2" drive, metric



43 piece set, in strong metal case

1 Zyklop ratchet with 1/4" drive, 1 Zyklop ratchet with 1/2" drive, 21 Zyklop sockets (metric), 2 Zyklop "flexible-lock" extensions (long) with freewheel sleeve, 1 adaptor with quick-release chuck, 1 Kraftform bitholding screwdriver with Rapidaptor quick-release chuck, 16 bits

05160785001	
●	8000 A 1 x 1/4"x152,0
●	8790 HMA 1 x 4,0x23,0; 1 x 4,5x23,0; 1 x 5,0x23,0; 1 x 5,5x23,0; 1 x 6,0x23,0; 1 x 7,0x23,0; 1 x 8,0x23,0; 1 x 9,0x23,0; 1 x 10,0x23,0; 1 x 12,0x23,0; 1 x 13,0x23,0
●	8784 A1 1 x 1/4"x1/4"x37,0
●	8796 LA 1 x 1/4"x150,0
●	8000 C 1 x 1/2"x277,0
●	8790 HMC 1 x 13,0x37,0; 1 x 14,0x37,0; 1 x 15,0x37,0; 1 x 16,0x37,0; 1 x 17,0x37,0; 1 x 18,0x37,0; 1 x 19,0x37,0; 1 x 21,0x37,0; 1 x 22,0x37,0; 1 x 24,0x37,0
●	8796 LC 1 x 1/2"x250,0
●	816 R 1 x 1/4"x119
●	800/4 Z 1 x 1,0x5,5x89
●	840/4 Z 1 x 3,0x89; 1 x 4,0x89; 1 x 5,0x89; 1 x 6,0x89
	Hex-Plus
+	851/4 Z PH 1 x PH 1x89; 1 x PH 2x89; 1 x PH 3x89
+	855/4 Z PZ 1 x PZ 1x89; 1 x PZ 2x89; 1 x PZ 3x89
+	867/4 Z TORX® 1 x TX 10x89; 1 x TX 15x89; 1 x TX 20x89;
	BO 1 x TX 25x89; 1 x TX 30x89

Tip

How to notice missing tools more quickly



Perfectly conceived in every detail: the storage case for the Zyklop Speed ratchet sets! The two-tone foam insert section means that the tools can be quickly and reliably replaced, and that missing tools can be detected immediately. The tools and their position can be clearly seen in the lid where they have been laser-etched, ensuring

that they are legible even when the insert section is covered with grease, dirt or oil. Additionally, the foam section can be removed and placed in the drawer of a tool cabinet or trolley.



"Flexible-lock-system"



The extensions from the premium lines are also equipped with the unique "flexible-lock-system". By activating this system, attachments can be fixed to the extension permanently – preventing slipping and any unintentional loss of the attachment. When the system is deactivated, the sockets can be attached as usual and changed in a flash.

Is it also possible to reverse the drive with oily hands?



The thumbwheel is designed in such a way that it offers outstanding grip and can, therefore, even be operated with oily fingers.

The Zyklop Speed Ratchets, 1/4"

Combine 5 types of ratchet

Kraftform Kompakt Zyklop Speed



26-piece set in a belt pouch

1 Zyklop Speed ratchet with 1/4" drive, 7 Zyklop sockets (metric), 1 Zyklop extension (long) with free-turning sleeve, 1 adaptor, 16 bits of 50 mm in length

05051045001	
8000 A	1 x 1/4"x152,0
8784 A1	1 x 1/4"x1/4"x37,0
8794 LA	1 x 1/4"x150,0
851/4 TZ PH	1 x PH 1x50; 1 x PH 2x50; 1 x PH 3x50
855/4 TZ PZ	1 x PZ 1x50; 1 x PZ 2x50
867/4 Z TORX®	1 x TX 10x50; 1 x TX 15x50; 1 x TX 20x50; 1 x TX 25x50; 1 x TX 27x50; 1 x TX 30x50
800/4 Z	1 x 1,0x5,5x50
840/4 Z Hex-Plus	1 x 3,0x50; 1 x 4,0x50; 1 x 5,0x50; 1 x 6,0x50
8790 HMA	1 x 5,5x23,0; 1 x 6,0x23,0; 1 x 7,0x23,0; 1 x 8,0x23,0; 1 x 10,0x23,0; 1 x 12,0x23,0; 1 x 13,0x23,0



” To learn more about this product, scan the QR code. “

8000 A Zyklop Speed Ratchet with 1/4" drive



Application: 1/4" square sockets and 1/4" adaptors with square drive, equipped with ball lock

Design: Flywheel design and easy-to-grip free-turning sleeve for faster work, swivel ratchet head, defined lock positions at 0° and 90° to the left and right as well as at 15° before 90° inwards, at 0° it can be used like a conventional screwdriver, pushbutton release, left/right switchover, fine-tooth design, small return angle of 5°

Handle: Multi-component Kraftform handle ensures minimum fatigue

05003500001	1/4"	152,0
-------------	------	-------

8000 A SB Zyklop Speed Ratchet with 1/4" drive

05073260001	1 x 1/4"x152,0	4013288 128034
-------------	----------------	-------------------





The Zyklop Metal Ratchets Push, 1/4"

With push-through square

8100 SA 7 Zyklop Metal Ratchet Set with push-through square, 1/4" drive, metric



28-piece set; in a surface-preserving, compact and extremely robust textile box; low volume and weight for simplified mobility

1 Zyklop Metal Ratchet with push-through square and 1/4" drive, 9 Zyklop sockets, 1 Zyklop extension (long) with free-turning sleeve, 1 wobble extension, 1 adaptor with quick-release chuck, 15 bits

05004017001	
8003 A	1 x 1/4"x141,0
8790 HMA	1 x 5,0x23,0; 1 x 5,5x23,0; 1 x 6,0x23,0; 1 x 7,0x23,0; 1 x 8,0x23,0; 1 x 10,0x23,0; 1 x 11,0x23,0; 1 x 12,0x23,0; 1 x 13,0x23,0
8794 LA	1 x 1/4"x150,0
8794 A	1 x 1/4"x56,0
8784 A1	1 x 1/4"x1/4"x37,0
851/1 Z PH	1 x PH 1x25; 1 x PH 2x25; 1 x PH 3x25
855/1 Z PZ	1 x PZ 1x25; 1 x PZ 2x25
867/1 Z TORX®	1 x TX 10x25; 1 x TX 15x25; 1 x TX 20x25; 1 x TX 25x25; 1 x TX 27x25; 1 x TX 30x25
840/1 Z Hex-Plus	1 x 3,0x25; 1 x 4,0x25; 1 x 5,0x25; 1 x 6,0x25

8100 SA 10 Zyklop Metal Ratchet Set with push-through square, 1/4" drive, imperial



28-piece set; in a surface-preserving, compact and extremely robust textile box; low volume and weight for simplified mobility

1 Zyklop Metal Ratchet with push-through square and 1/4" drive, 9 Zyklop sockets, 1 Zyklop extension (long) with free-turning sleeve, 1 wobble extension, 1 adaptor with quick-release chuck, 15 bits

05004020001	
8003 A	1 x 1/4"x141,0
8790 HMA	1 x 3/16"x23,0; 1 x 7/32"x23,0; 1 x 1/4"x23,0; 1 x 9/32"x23,0; 1 x 5/16"x23,0; 1 x 11/32"x23,0; 1 x 3/8"x23,0; 1 x 7/16"x23,0; 1 x 1/2"x23,0
8794 LA	1 x 1/4"x150,0
8794 A	1 x 1/4"x56,0
8784 A1	1 x 1/4"x1/4"x37,0
851/1 Z PH	1 x PH 1x25; 1 x PH 2x25; 1 x PH 3x25
855/1 Z PZ	1 x PZ 1x25; 1 x PZ 2x25
867/1 Z TORX®	1 x TX 10x25; 1 x TX 15x25; 1 x TX 20x25; 1 x TX 25x25; 1 x TX 27x25; 1 x TX 30x25
840/1 Z Hex-Plus	1 x 5/32"x25; 1 x 3/16"x25; 1 x 7/32"x25; 1 x 1/4"x25

8003 A Zyklop Metal Ratchet with push-through square and 1/4" drive



Application: 1/4" square sockets as well as for 1/4" adaptors with square drive, with ball locking device

Design: Forged, full metal ratchet (chrome-molybdenum) that is extremely robust with a long service life; slim design to enable work in very confined spaces; the dual-ratchet-teeth design means that a 76 fine-toothing division can be achieved from the 38 robust teeth with a return angle of only 4.7°; simple direction change with the undetachable push-through square and very secure socket lock mechanism

05004003001	1/4"	141,0 mm	21 mm	22 mm



” To learn more about this product, scan the QR code. “

Tip

The Zyklop Metal Ratchets Push



Forged, full metal ratchet (chrome-molybdenum) that is extremely robust with a long service life; slim design to enable work in very confined spaces.

Textile boxes



The textile boxes offer dramatically improved portability, and are space-saving to boot!

This means you can now carry the same collection of tools, in a much more compact and comfortable package. The hassle of running back and forth for the right tools has now become a thing of the past. And the much lower weight of a set makes carrying more convenient than ever before. The textile box including the tool will even survive a fall undamaged. And: it leaves absolutely no signs of scratches on sensitive surfaces.



“Take it easy”



“Take it easy” tool finder system – with profile and size colour-coding for quick and easy tool selection. Colour-coded system for hexagon drive screws (L-Keys, Zyklop bit sockets), external hex drive screws and nuts (Joker wrenches, Zyklop sockets and Zyklop bit sockets with holding function), and TORX® drive screws (L-Keys, Zyklop bit sockets).

The Zyklop Metal Ratchets Switch, 1/4"

With switch lever

8100 SA 8 Zyklop Metal Ratchet Set with switch lever, 1/4" drive, metric



28-piece set; in a surface-preserving, compact and extremely robust textile box; low volume and weight for simplified mobility

1 Zyklop Metal Ratchet with switch lever and 1/4" drive, 9 Zyklop sockets, 1 Zyklop extension (long) with free-turning sleeve, 1 wobble extension, 1 adaptor with quick-release chuck, 15 bits

05004018001		
○	8004 A	1 x 1/4"x141,0
●	8790 HMA	1 x 5,0x23,0; 1 x 5,5x23,0; 1 x 6,0x23,0; 1 x 7,0x23,0; 1 x 8,0x23,0; 1 x 10,0x23,0; 1 x 11,0x23,0; 1 x 12,0x23,0; 1 x 13,0x23,0
⊗	8794 LA	1 x 1/4"x150,0
⊗	8794 A	1 x 1/4"x56,0
⊗	8784 A1	1 x 1/4"x1/4"x37,0
+	851/1 Z PH	1 x PH 1x25; 1 x PH 2x25; 1 x PH 3x25
+	855/1 Z PZ	1 x PZ 1x25; 1 x PZ 2x25
⊕	867/1 Z TORX®	1 x TX 10x25; 1 x TX 15x25; 1 x TX 20x25; 1 x TX 25x25; 1 x TX 27x25; 1 x TX 30x25
○	840/1 Z Hex-Plus	1 x 3,0x25; 1 x 4,0x25; 1 x 5,0x25; 1 x 6,0x25

8100 SA 11 Zyklop Metal Ratchet Set with switch lever, 1/4" drive, imperial



28-piece set; in a surface-preserving, compact and extremely robust textile box; low volume and weight for simplified mobility

1 Zyklop Metal Ratchet with switch lever and 1/4" drive, 9 Zyklop sockets, 1 Zyklop extension (long) with free-turning sleeve, 1 wobble extension, 1 adaptor with quick-release chuck, 15 bits

05004021001		
○	8004 A	1 x 1/4"x141,0
●	8790 HMA	1 x 3/16"x23,0; 1 x 7/32"x23,0; 1 x 1/4"x23,0; 1 x 9/32"x23,0; 1 x 5/16"x23,0; 1 x 11/32"x23,0; 1 x 3/8"x23,0; 1 x 7/16"x23,0; 1 x 1/2"x23,0
⊗	8794 LA	1 x 1/4"x150,0
⊗	8794 A	1 x 1/4"x56,0
⊗	8784 A1	1 x 1/4"x1/4"x37,0
+	851/1 Z PH	1 x PH 1x25; 1 x PH 2x25; 1 x PH 3x25
+	855/1 Z PZ	1 x PZ 1x25; 1 x PZ 2x25
⊕	867/1 Z TORX®	1 x TX 10x25; 1 x TX 15x25; 1 x TX 20x25; 1 x TX 25x25; 1 x TX 27x25; 1 x TX 30x25
○	840/1 Z Hex-Plus	1 x 5/32"x25; 1 x 3/16"x25; 1 x 7/32"x25; 1 x 1/4"x25

8004 A Zyklop Metal Ratchet with switch lever and 1/4" drive



Application: 1/4" square sockets as well as for 1/4" adaptors with square drive, with ball locking device

Design: Forged, full metal ratchet (chrome-molybdenum) that is extremely robust with a long service life; slim design to enable work in very confined spaces; fine-tooth mechanism with 72 teeth for a return angle of only 5°; switch lever for convenient change of direction; secure socket locking function

05004004001	1/4"	141,0	19	22

Tip

The Zyklop Metal Ratchets Switch



Extremely slim. Long leverage. Very robust without any torque limitation. Forged, full metal ratchet out of chrome molybdenum.

Textile boxes



The textile boxes offer dramatically improved portability, and are space-saving to boot!

This means you can now carry the same collection of tools, in a much more compact and comfortable package. The hassle of running back and forth for the right tools has now become a thing of the past. And the much lower weight of a set makes carrying more convenient than ever before. The textile box including the tool will even survive a fall undamaged. And: it leaves absolutely no signs of scratches on sensitive surfaces.



“Take it easy”



“Take it easy” tool finder system – with profile and size colour-coding for quick and easy tool selection. Colour-coded system for hexagon drive screws (L-Keys, Zyklop bit sockets), external hex drive screws and nuts (Joker wrenches, Zyklop sockets and Zyklop bit sockets with holding function), and TORX® drive screws (L-Keys, Zyklop bit sockets).

Zyklop accessories, 1/4"

The perfect add-on for all Zyklop ratchets

8790 HMA Zyklop 1/4" socket



Application: Hexagon headed bolts, screws and nuts

Design: Manual and (non-impact) machine applications, ball intercept ring, knurls at base for precision handling in manual operations, chrome vanadium, brushed chrome-plated finish. Take it easy toolfinder: Colour coding to enable the desired socket to be easily located.

	mm	mm	mm	mm	mm	mm
05003501001	4,0		23,0	6,9	13,0	10,0
05003502001	4,5		23,0	7,5	13,0	10,0
05003503001	5,0		23,0	8,2	13,0	10,0
05003504001	5,5		23,0	8,8	13,0	10,0
05003505001	6,0		23,0	9,4	13,0	10,0
05003506001	7,0		23,0	11,0	13,0	10,0
05003507001	8,0		23,0	12,0	13,0	10,0
05003508001	9,0		23,0	13,0	14,0	10,0
05003509001	10,0		23,0	14,5	14,5	-
05003510001	11,0		23,0	16,0	15,0	13,0
05003511001	12,0		23,0	17,0	16,0	13,0
05003512001	13,0		23,0	18,0	17,0	13,0
05003513001	14,0		23,0	20,0	18,0	13,0
05003514001		3/16"	23,0	7,5	13,0	10,0
05003515001		7/32"	23,0	8,8	13,0	10,0
05003516001		1/4"	23,0	11,0	13,0	10,0
05003517001		9/32"	23,0	11,0	13,0	10,0
05003518001		5/16"	23,0	12,0	13,0	10,0
05003519001		11/32"	23,0	13,0	14,0	10,0
05003520001		3/8"	23,0	14,5	14,5	-
05003521001		7/16"	23,0	16,0	15,0	13,0
05003522001		1/2"	23,0	18,0	17,0	13,0
05003523001		9/16"	23,0	20,0	18,0	13,0

8796 SA Zyklop "flexible-lock" extension with free-turning sleeve, short, 1/4"



Application: 1/4" square drive sockets with ball lock

Design: Flexible-lock-system either for permanent interlocking or fast change of accessories, free-turning sleeve for rapid tightening or loosening of screws and nuts, chrome vanadium, brushed chrome-plated finish

	mm	mm
05003530001	1/4"	75,0

8796 LA Zyklop "flexible-lock" extension with free-turning sleeve, long, 1/4"



Application: 1/4" square drive sockets with ball lock

Design: Flexible-lock-system either for permanent interlocking or fast change of accessories, free-turning sleeve for rapid tightening or loosening of screws and nuts, chrome vanadium, brushed chrome-plated finish



	mm	mm
05003531001	1/4"	150,0

8794 SA Zyklop extension with free-turning sleeve, short, 1/4"



Application: 1/4" square drive sockets with ball lock

Design: Easy-to-grip free-turning sleeve for rapid tightening or loosening of screws and nuts, chrome vanadium, brushed chrome-plated finish



		mm
05003525001	1/4"	75,0

8794 LA Zyklop extension with free-turning sleeve, long, 1/4"



Application: 1/4" square drive sockets with ball lock

Design: Easy-to-grip free-turning sleeve for rapid tightening or loosening of screws and nuts, chrome vanadium, brushed chrome-plated finish



		mm
05003526001	1/4"	150,0

8789 A Zyklop sliding T-handle, 1/4"



Application: 1/4" square drive sockets with ball lock

Design: Sliding drive, chrome vanadium, brushed chrome-plated finish

		mm
05003524001	1/4"	110,0

Tip

How to avoid the need for two socket sets – one for manual and one for machine operations



The manual and machine sockets can be used both for hand and power tools use (non-impact). Users need just one socket set for all applications.



"Flexible-lock-system"



The extensions from the premium lines are also equipped with the unique "flexible-lock-system". By activating this system, attachments can be fixed to the extension permanently – preventing slipping and any unintentional loss of the attachment. When the system is deactivated, the sockets can be attached as usual and changed in a flash.

The free-turning sleeve



The free-turning sleeve effectively speeds up the tightening or loosening of screws and bolts.



8795 A Zyklop universal joint, 1/4"



Application: 1/4" square drive sockets with ball lock

Design: Chrome vanadium/chrome molybdenum, brushed chrome-plated finish

			mm
05003528001	1/4"	35,5	

8794 A Zyklop wobble extension, 1/4"



Application: 1/4" square drive sockets with ball lock

Design: Swivels through 15°, chrome vanadium, brushed chrome-plated finish

			mm
05003527001	1/4"	56,0	

8784 A1 Zyklop bit adaptor, 1/4"



Application: Suitable for 1/4" hex bits as per DIN ISO 1173-C 6,3 and E 6,3 and Wera series 1 and 4

Design: Quick-release chuck for fast bit changes, chromium vanadium

				mm
05003529001	1/4"	1/4"	37,0	

Tip

How to work well in confined installation areas



The Zyklop wobble extensions pivot through 15° in all directions. This enables rapid and precise work in concealed or confined installation areas.





Zyklop Ratchets, 3/8"



Zyklop Speed

146



Zyklop Metal Push

150



Zyklop Metal Switch

152



Zyklop Accessories

154



The Zyklop Speed Ratchets, $\frac{3}{8}$ "

5 types of ratchet in 1 tool

8100 SB 6 Zyklop Speed Ratchet Set, $\frac{3}{8}$ " drive, metric

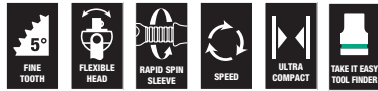

29-piece set; in a surface-preserving, compact and extremely robust textile box; low volume and weight for simplified mobility

1 Zyklop Speed Ratchet with $\frac{3}{8}$ " drive, 9 Zyklop sockets, 1 Zyklop extension (long) with free-turning sleeve, 1 wobble extension, 1 adaptor with quick-release chuck, 16 bits

05004046001	
⊙	8000 B 1 x 3/8"x199,0
⊙	8790 HMB 1 x 8,0x29,0; 1 x 10,0x29,0; 1 x 12,0x29,0; 1 x 13,0x29,0; 1 x 15,0x29,0; 1 x 16,0x30,0; 1 x 17,0x30,0; 1 x 18,0x30,0; 1 x 19,0x30,0
⊙	8794 LB 1 x 3/8"x200,0
⊙	8794 B 1 x 3/8"x76,0
⊙	8784 B1 1 x 1/4"x3/8"x44,0
+	851/4 TZ PH 1 x PH 1x50; 1 x PH 2x50; 1 x PH 3x50
+	855/4 TZ PZ 1 x PZ 1x50; 1 x PZ 2x50; 1 x PZ 3x50
⊗	867/4 Z TORX® 1 x TX 20x50; 1 x TX 25x50; 1 x TX 27x50; 1 x TX 30x50; 1 x TX 40x50
○	840/4 Z 1 x 4,0x50; 1 x 5,0x50; 1 x 6,0x50; 1 x 8,0x50
○	Hex-Plus
●	800/4 Z 1 x 1,0x5,5x50

8100 SB 9 Zyklop Speed Ratchet Set, $\frac{3}{8}$ " drive, imperial

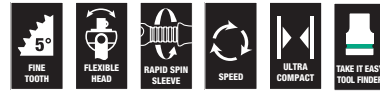

29-piece set; in a surface-preserving, compact and extremely robust textile box; low volume and weight for simplified mobility

1 Zyklop Speed Ratchet with $\frac{3}{8}$ " drive, 9 Zyklop sockets, 1 Zyklop extension (long) with free-turning sleeve, 1 wobble extension, 1 adaptor with quick-release chuck, 16 bits

05004049001	
⊙	8000 B 1 x 3/8"x199,0
⊙	8790 HMB 1 x 1/4"x29,0; 1 x 5/16"x29,0; 1 x 3/8"x29,0; 1 x 7/16"x29,0; 1 x 1/2"x29,0; 1 x 9/16"x29,0; 1 x 5/8"x30,0; 1 x 11/16"x30,0; 1 x 3/4"x30,0
⊙	8794 LB 1 x 3/8"x200,0
⊙	8794 B 1 x 3/8"x76,0
⊙	8784 B1 1 x 1/4"x3/8"x44,0
+	851/4 TZ PH 1 x PH 1x50; 1 x PH 2x50; 1 x PH 3x50
+	855/4 TZ PZ 1 x PZ 1x50; 1 x PZ 2x50; 1 x PZ 3x50
⊗	867/4 Z TORX® 1 x TX 20x50; 1 x TX 25x50; 1 x TX 27x50; 1 x TX 30x50; 1 x TX 40x50
○	840/4 Z 1 x 3/16"x50; 1 x 7/32"x50; 1 x 1/4"x50;
○	Hex-Plus 1 x 5/16"x50
●	800/4 Z 1 x 1,0x5,5x50

8100 SB 2 Zyklop Speed Ratchet Set, 3/8" drive, metric



43-piece set in strong metal case

1 Zyklop ratchet with 3/8" drive, 18 Zyklop sockets (metric), 2 Zyklop "flexible-lock" extensions (short and long) with free-turning sleeve, 1 sliding T-handle, 1 wobble extension, 1 universal joint, 1 adaptor with quick-release chuck, 18 bits

05003594001		
⊙	8000 B	1 x 3/8"x199,0
⊙	8790 HMB	1 x 6,0x29,0; 1 x 7,0x29,0; 1 x 8,0x29,0; 1 x 9,0x29,0; 1 x 10,0x29,0; 1 x 11,0x29,0; 1 x 12,0x29,0; 1 x 13,0x29,0; 1 x 14,0x29,0; 1 x 15,0x29,0; 1 x 16,0x30,0; 1 x 17,0x30,0; 1 x 18,0x30,0; 1 x 19,0x30,0; 1 x 20,0x30,0; 1 x 21,0x30,0; 1 x 22,0x30,0; 1 x 24,0x32,0
⊙	8789 B	1 x 3/8"x165,0
⊙	8794 B	1 x 3/8"x76,0
⊙	8795 B	1 x 3/8"x50,0
⊙	8784 B1	1 x 1/4"x3/8"x44,0
⊙	8796 SB	1 x 3/8"x125,0
⊙	8796 LB	1 x 3/8"x200,0
⊙	840/1 Z	1 x 3,0x25; 1 x 4,0x25; 1 x 5,0x25; 1 x 6,0x25; Hex-Plus 1 x 8,0x25; 1 x 10,0x25
⊙	867/1 Z TORX®	1 x TX 10x25; 1 x TX 15x25; 1 x TX 20x25; B0 1 x TX 25x25; 1 x TX 27x25; 1 x TX 30x25; 1 x TX 40x25
⊙	800/1 Z	1 x 1,0x5,5x25
⊙	851/1 Z PH	1 x PH 2x25; 1 x PH 3x25
⊙	855/1 Z PZ	1 x PZ 2x25; 1 x PZ 3x25

Tip

Zyklop "6 in 1"



1. Fine-tooth ratchet
2. Flex-head ratchet
3. Angle ratchet
4. Quick-release ratchet
5. Power ratchet
6. Screwdriver

Textile boxes



The textile boxes offer dramatically improved portability, and are space-saving to boot!

This means you can now carry the same collection of tools, in a much more compact and comfortable package. The hassle of running back and forth for the right tools has now become a thing of the past. And the much lower weight of a set makes carrying more convenient than ever before. The textile box including the tool will even survive a fall undamaged. And: it leaves absolutely no signs of scratches on sensitive surfaces.



"Take it easy"



"Take it easy" tool finder system – with profile and size colour-coding for quick and easy tool selection. Colour-coded system for hexagon drive screws (L-Keys, Zyklop bit sockets), external hex drive screws and nuts (Joker wrenches, Zyklop sockets and Zyklop bit sockets with holding function), and TORX® drive screws (L-Keys, Zyklop bit sockets).

The Zyklop Speed Ratchets, $\frac{3}{8}$ "

5 types of ratchet in 1 tool

8100 SB 4 Zyklop Speed Ratchet Set, $\frac{3}{8}$ " drive, imperial

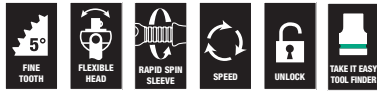

38-piece set in strong metal case

1 Zyklop ratchet with $\frac{3}{8}$ " drive, 12 Zyklop sockets (imperial), 2 Zyklop "flexible-lock" extensions (short and long) with free-turning sleeve, 1 sliding T-handle, 1 wobble extension, 1 universal joint, 1 adaptor with quick-release chuck, 19 bits

05003596001		
●	8000 B	1 x 3/8"x199,0
●	8790 HMB	1 x 1/4"x29,0; 1 x 5/16"x29,0; 1 x 11/32"x29,0; 1 x 3/8"x29,0; 1 x 7/16"x29,0; 1 x 1/2"x29,0; 1 x 9/16"x29,0; 1 x 5/8"x30,0; 1 x 11/16"x30,0; 1 x 3/4"x30,0; 1 x 13/16"x30,0; 1 x 7/8"x30,0
○	8789 B	1 x 3/8"x165,0
○	8794 B	1 x 3/8"x76,0
○	8795 B	1 x 3/8"x50,0
○	8784 B1	1 x 1/4"x3/8"x44,0
○	8796 SB	1 x 3/8"x125,0
○	8796 LB	1 x 3/8"x200,0
⊕	867/1 Z TORX®	1 x TX 10x25; 1 x TX 15x25; 1 x TX 20x25; B0 1 x TX 25x25; 1 x TX 27x25; 1 x TX 30x25; 1 x TX 40x25
⊖	800/1 Z	1 x 1,0x5,5x25
⊕	851/1 Z PH	1 x PH 2x25; 1 x PH 3x25
⊕	855/1 Z PZ	1 x PZ 2x25; 1 x PZ 3x25
○	840/1 Z	1 x 5/64"x25; 1 x 3/32"x25; 1 x 1/8"x25; Hex-Plus 1 x 9/64"x25; 1 x 5/32"x25; 1 x 3/16"x25; 1 x 7/32"x25

8000 B Zyklop Speed Ratchet with $\frac{3}{8}$ " drive



Application: $\frac{3}{8}$ " square drive sockets and $\frac{3}{8}$ " adaptors with square drive, equipped with ball lock

Design: Flywheel design and easy-to-grip free-turning sleeve for faster work, swivel ratchet head, defined lock positions at 0° and 90° to the left and right as well as at 15° before 90° inwards, at 0° it can be used like a conventional screwdriver, pushbutton release, left/right switchover, fine-tooth design, small return angle of 5°

Handle: Multi-component Kraftform handle ensures minimum fatigue

			mm
05003550001	$\frac{3}{8}$ "	199,0	

8000 B SB Zyklop Speed Ratchet with $\frac{3}{8}$ " drive

			mm
05073261001	$\frac{3}{8}$ "	199,0	





Tip

How to notice missing tools more quickly



Perfectly conceived in every detail: the storage case for the Zyklop Speed ratchet sets! The two-tone foam insert section means that the tools can be quickly and reliably replaced, and that missing tools can be detected immediately. The tools and their position can be clearly seen in the lid where they have been laser-etched, ensuring

that they are legible even when the insert section is covered with grease, dirt or oil. Additionally, the foam section can be removed and placed in the drawer of a tool cabinet or trolley.



“Flexible-lock-system”

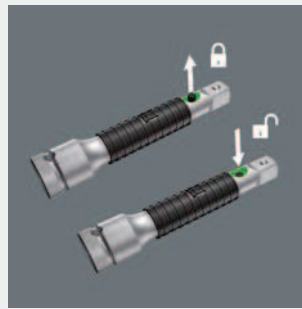

The extensions from the premium lines are also equipped with the unique “flexible-lock-system”. By activating this system, attachments can be fixed to the extension permanently – preventing slipping and any unintentional loss of the attachment. When the system is deactivated, the sockets can be attached as usual and changed in a flash.

Is it also possible to reverse the drive with oily hands?



The thumbwheel is designed in such a way that it offers outstanding grip and can, therefore, even be operated with oily fingers.

The Zyklop Metal Ratchets Push, $\frac{3}{8}$ "

With push-through square

8100 SB 7 Zyklop Metal Ratchet Set with push-through square, $\frac{3}{8}$ " drive, metric

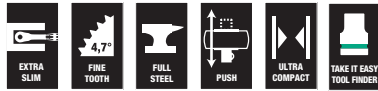

29-piece set; in a surface-preserving, compact and extremely robust textile box; low volume and weight for simplified mobility

1 Zyklop Metal Ratchet with $\frac{3}{8}$ " drive, 9 Zyklop sockets, 1 Zyklop extension (long) with free-turning sleeve, 1 wobble extension, 1 adaptor with quick-release chuck, 16 bits

05004047001	
8003 B	1 x 3/8"x222,0
8790 HMB	1 x 8,0x29,0; 1 x 10,0x29,0; 1 x 12,0x29,0; 1 x 13,0x29,0; 1 x 15,0x29,0; 1 x 16,0x30,0; 1 x 17,0x30,0; 1 x 18,0x30,0; 1 x 19,0x30,0
8794 LB	1 x 3/8"x200,0
8794 B	1 x 3/8"x76,0
8784 B1	1 x 1/4"x3/8"x44,0
851/1 Z PH	1 x PH 1x25; 1 x PH 2x25; 1 x PH 3x25
855/1 Z PZ	1 x PZ 1x25; 1 x PZ 2x25
867/1 Z TORX®	1 x TX 15x25; 1 x TX 20x25; 1 x TX 25x25; 1 x TX 27x25; 1 x TX 30x25; 1 x TX 40x25
840/1 Z Hex-Plus	1 x 3,0x25; 1 x 4,0x25; 1 x 5,0x25; 1 x 6,0x25; 1 x 8,0x25

8100 SB 10 Zyklop Metal Ratchet Set with push-through square, $\frac{3}{8}$ " drive, imperial

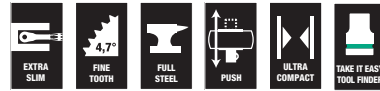

29-piece set; in a surface-preserving, compact and extremely robust textile box; low volume and weight for simplified mobility

1 Zyklop Metal Ratchet with $\frac{3}{8}$ " drive, 9 Zyklop sockets, 1 Zyklop extension (long) with free-turning sleeve, 1 wobble extension, 1 adaptor with quick-release chuck, 16 bits

05004050001	
8003 B	1 x 3/8"x222,0
8790 HMB	1 x 1/4"x29,0; 1 x 5/16"x29,0; 1 x 3/8"x29,0; 1 x 7/16"x29,0; 1 x 1/2"x29,0; 1 x 9/16"x29,0; 1 x 5/8"x30,0; 1 x 11/16"x30,0; 1 x 3/4"x30,0
8794 LB	1 x 3/8"x200,0
8794 B	1 x 3/8"x76,0
8784 B1	1 x 1/4"x3/8"x44,0
851/1 Z PH	1 x PH 1x25; 1 x PH 2x25; 1 x PH 3x25
855/1 Z PZ	1 x PZ 1x25; 1 x PZ 2x25
867/1 Z TORX®	1 x TX 15x25; 1 x TX 20x25; 1 x TX 25x25; 1 x TX 27x25; 1 x TX 30x25; 1 x TX 40x25
840/1 Z Hex-Plus	1 x 5/32"x25; 1 x 3/16"x25; 1 x 7/32"x25; 1 x 1/4"x25; 1 x 5/16"x25

8003 B Zyklop Metal Ratchet with push-through square and $\frac{3}{8}$ " drive



Application: $\frac{3}{8}$ " square sockets as well as for $\frac{3}{8}$ " adaptors with square drive, with ball locking device

Design: Forged, full metal ratchet (chrome-molybdenum) that is extremely robust with a long service life; slim design to enable work in very confined spaces; the dual-ratchet-teeth design means that a 76 fine-toothing division can be achieved from the 38 robust teeth with a return angle of only 4.7°; simple direction change with the undetachable push-through square and very secure socket lock mechanism

	mm	mm	mm	
05004033001	$\frac{3}{8}$ "	222,0	27	29

Tip

The Zyklop Metal Ratchets Push



Forged, full metal ratchet (chrome-molybdenum) that is extremely robust with a long service life; slim design to enable work in very confined spaces.

Textile boxes



The textile boxes offer dramatically improved portability, and are space-saving to boot!

This means you can now carry the same collection of tools, in a much more compact and comfortable package. The hassle of running back and forth for the right tools has now become a thing of the past. And the much lower weight of a set makes carrying more convenient than ever before. The textile box including the tool will even survive a fall undamaged. And: it leaves absolutely no signs of scratches on sensitive surfaces.



"Take it easy"



"Take it easy" tool finder system – with profile and size colour-coding for quick and easy tool selection. Colour-coded system for hexagon drive screws (L-Keys, Zyklop bit sockets), external hex drive screws and nuts (Joker wrenches, Zyklop sockets and Zyklop bit sockets with holding function), and TORX® drive screws (L-Keys, Zyklop bit sockets).

The Zyklop Metal Ratchets Switch, $\frac{3}{8}$ "

With switch lever

8100 SB 8 Zyklop Metal Ratchet Set with switch lever, $\frac{3}{8}$ " drive, metric



29-piece set; in a surface-preserving, compact and extremely robust textile box; low volume and weight for simplified mobility

1 Zyklop Metal Ratchet with $\frac{3}{8}$ " drive, 9 Zyklop sockets, 1 Zyklop extension (long) with free-turning sleeve, 1 wobble extension, 1 adaptor with quick-release chuck, 16 bits

05004048001		
○	8004 B	1 x 3/8"x222,0
●	8790 HMB	1 x 8,0x29,0; 1 x 10,0x29,0; 1 x 12,0x29,0; 1 x 13,0x29,0; 1 x 15,0x29,0; 1 x 16,0x30,0; 1 x 17,0x30,0; 1 x 18,0x30,0; 1 x 19,0x30,0
⊗	8794 LB	1 x 3/8"x200,0
⊗	8794 B	1 x 3/8"x76,0
⊗	8784 B1	1 x 1/4"x3/8"x44,0
+	851/1 Z PH	1 x PH 1x25; 1 x PH 2x25; 1 x PH 3x25
+	855/1 Z PZ	1 x PZ 1x25; 1 x PZ 2x25
⊗	867/1 Z TORX®	1 x TX 15x25; 1 x TX 20x25; 1 x TX 25x25; 1 x TX 27x25; 1 x TX 30x25; 1 x TX 40x25
○	840/1 Z Hex-Plus	1 x 3,0x25; 1 x 4,0x25; 1 x 5,0x25; 1 x 6,0x25; 1 x 8,0x25

8100 SB 11 Zyklop Metal Ratchet Set with switch lever, $\frac{3}{8}$ " drive, imperial



29-piece set; in a surface-preserving, compact and extremely robust textile box; low volume and weight for simplified mobility

1 Zyklop Metal Ratchet with $\frac{3}{8}$ " drive, 9 Zyklop sockets, 1 Zyklop extension (long) with free-turning sleeve, 1 wobble extension, 1 adaptor with quick-release chuck, 16 bits

05004051001		
○	8004 B	1 x 3/8"x222,0
●	8790 HMB	1 x 1/4"x29,0; 1 x 5/16"x29,0; 1 x 3/8"x29,0; 1 x 7/16"x29,0; 1 x 1/2"x29,0; 1 x 9/16"x29,0; 1 x 5/8"x30,0; 1 x 11/16"x30,0; 1 x 3/4"x30,0
⊗	8794 LB	1 x 3/8"x200,0
⊗	8794 B	1 x 3/8"x76,0
⊗	8784 B1	1 x 1/4"x3/8"x44,0
+	851/1 Z PH	1 x PH 1x25; 1 x PH 2x25; 1 x PH 3x25
+	855/1 Z PZ	1 x PZ 1x25; 1 x PZ 2x25
⊗	867/1 Z TORX®	1 x TX 15x25; 1 x TX 20x25; 1 x TX 25x25; 1 x TX 27x25; 1 x TX 30x25; 1 x TX 40x25
○	840/1 Z Hex-Plus	1 x 5/32"x25; 1 x 3/16"x25; 1 x 7/32"x25; 1 x 1/4"x25; 1 x 5/16"x25

8004 B Zyklop Metal Ratchet with switch lever and $\frac{3}{8}$ " drive



Application: $\frac{3}{8}$ " square sockets as well as for $\frac{3}{8}$ " adaptors with square drive, with ball locking device

Design: Forged, full metal ratchet (chrome-molybdenum) that is extremely robust with a long service life; slim design to enable work in very confined spaces; fine-tooth mechanism with 72 teeth for a return angle of only 5°; switch lever for convenient change of direction; secure socket locking function

	mm	mm	mm	mm
05004034001	$\frac{3}{8}$ "	222,0	26	29

Tip

The Zyklop Metal Ratchets Switch



Extremely slim. Long leverage. Very robust without any torque limitation. Forged, full metal ratchet out of chrome molybdenum.

Textile boxes



The textile boxes offer dramatically improved portability, and are space-saving to boot!

This means you can now carry the same collection of tools, in a much more compact and comfortable package. The hassle of running back and forth for the right tools has now become a thing of the past. And the much lower weight of a set makes carrying more convenient than ever before. The textile box including the tool will even survive a fall undamaged. And: it leaves absolutely no signs of scratches on sensitive surfaces.



“Take it easy”



“Take it easy” tool finder system – with profile and size colour-coding for quick and easy tool selection. Colour-coded system for hexagon drive screws (L-Keys, Zyklop bit sockets), external hex drive screws and nuts (Joker wrenches, Zyklop sockets and Zyklop bit sockets with holding function), and TORX® drive screws (L-Keys, Zyklop bit sockets).

Zyklop Accessories, $\frac{3}{8}$ "

The perfect add-on for all Zyklop ratchets

8790 HMB Zyklop $\frac{3}{8}$ " socket



Application: Hexagon headed bolts, screws and nuts

Design: Manual and (non-impact) machine applications, ball intercept ring, knurls at base for precision handling in manual operations, chrome vanadium, brushed chrome-plated finish
Take it easy toolfinder: Colour coding to enable the desired socket to be easily located.

	mm	mm	mm	mm	mm	mm
05003551001	6,0		29,0	10,5	18,0	12,0
05003552001	7,0		29,0	11,0	18,0	12,0
05003553001	8,0		29,0	12,2	18,0	12,0
05003554001	9,0		29,0	13,5	18,0	12,0
05003555001	10,0		29,0	14,5	18,0	12,0
05003556001	11,0		29,0	16,0	18,0	12,0
05003557001	12,0		29,0	17,0	18,0	12,0
05003558001	13,0		29,0	18,5	20,0	12,0
05003559001	14,0		29,0	19,5	22,0	12,0
05003560001	15,0		29,0	21,0	24,0	12,0
05003561001	16,0		30,0	22,0	24,0	12,0
05003562001	17,0		30,0	23,5	24,0	12,0
05003563001	18,0		30,0	24,5	24,0	18,0
05003564001	19,0		30,0	26,0	24,0	18,0
05003565001	20,0		30,0	28,0	25,0	18,0
05003566001	21,0		30,0	28,0	25,0	18,0
05003567001	22,0		30,0	32,0	25,0	18,0
05003568001	24,0		32,0	32,0	25,0	20,0
05003569001		$\frac{1}{4}$ "	29,0	11,0	18,0	12,0
05003570001		$\frac{5}{16}$ "	29,0	12,2	18,0	12,0
05003571001		$\frac{11}{32}$ "	29,0	13,5	18,0	12,0
05003572001		$\frac{3}{8}$ "	29,0	14,5	18,0	12,0
05003573001		$\frac{7}{16}$ "	29,0	16,0	18,0	12,0
05003574001		$\frac{1}{2}$ "	29,0	18,5	20,0	12,0
05003575001		$\frac{9}{16}$ "	29,0	19,5	22,0	12,0
05003576001		$\frac{5}{8}$ "	30,0	22,0	24,0	12,0
05003577001		$\frac{11}{16}$ "	30,0	23,0	24,0	18,0
05003578001		$\frac{3}{4}$ "	30,0	26,0	24,0	18,0
05003579001		$\frac{13}{16}$ "	30,0	28,0	25,0	18,0
05003580001		$\frac{7}{8}$ "	30,0	32,0	25,0	18,0

8796 SB Zyklop "flexible-lock" extension with free-turning sleeve, short, $\frac{3}{8}$ "



Application: $\frac{3}{8}$ " square drive sockets with ball lock

Design: Flexible-lock-system either for permanent interlocking or fast change of accessories, free-turning sleeve for rapid tightening or loosening of screws and nuts, chrome vanadium, brushed chrome-plated finish

	mm	mm
05003591001	$\frac{3}{8}$ "	125,0

8796 LB Zyklop "flexible-lock" extension with free-turning sleeve, long, $\frac{3}{8}$ "



Application: $\frac{3}{8}$ " square drive sockets with ball lock

Design: Flexible-lock-system either for permanent interlocking or fast change of accessories, free-turning sleeve for rapid tightening or loosening of screws and nuts, chrome vanadium, brushed chrome-plated finish



	mm	mm
05003592001	$\frac{3}{8}$ "	200,0

8794 SB Zyklop extension with free-turning sleeve, short, $\frac{3}{8}$ "



Application: $\frac{3}{8}$ " square drive sockets with ball lock

Design: Easy-to-grip free-turning sleeve for rapid tightening or loosening of screws and nuts, chrome vanadium, brushed chrome-plated finish



	 	mm
05003582001	$\frac{3}{8}$ "	125,0

8794 LB Zyklop extension with free-turning sleeve, long, $\frac{3}{8}$ "



Application: $\frac{3}{8}$ " square drive sockets with ball lock

Design: Easy-to-grip free-turning sleeve for rapid tightening or loosening of screws and nuts, chrome vanadium, brushed chrome-plated finish

	 	mm
05003583001	$\frac{3}{8}$ "	200,0

Tip

How to avoid the need for two socket sets – one for manual and one for machine operations



The manual and machine sockets can be used both for hand and power tools use (non-impact). Users need just one socket set for all applications.



"Flexible-lock-system"

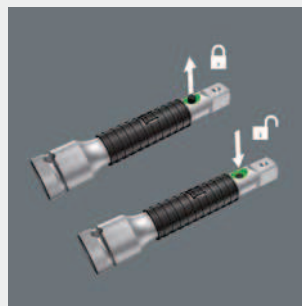

The extensions from the premium lines are also equipped with the unique "flexible-lock-system". By activating this system, attachments can be fixed to the extension permanently – preventing slipping and any unintentional loss of the attachment. When the system is deactivated, the sockets can be attached as usual and changed in a flash.

The free-turning sleeve



The free-turning sleeve effectively speeds up the tightening or loosening of screws and bolts.

Zyklop accessories, $\frac{3}{8}$ "





The perfect add-on for all Zyklop ratchets

8784 B1 Zyklop bit adaptor, $\frac{3}{8}$ "



Application: Suitable for $\frac{1}{4}$ " hex bits as per DIN ISO 1173-C 6,3 and E 6,3 and Wera series 1 and 4

Design: Quick-release chuck for fast bit changes, chromium vanadium



			
05003590001	$\frac{1}{4}$ "	$\frac{3}{8}$ "	44,0 mm

8789 B Zyklop sliding T-handle, $\frac{3}{8}$ "



Application: $\frac{3}{8}$ " square drive sockets with ball lock

Design: Sliding drive, chrome vanadium, brushed chrome-plated finish



		
05003581001	$\frac{3}{8}$ "	165,0 mm

8795 B Zyklop universal joint, $\frac{3}{8}$ "



Application: $\frac{3}{8}$ " square drive sockets with ball lock

Design: Chrome vanadium/chrome molybdenum, brushed chrome-plated finish



		
05003585001	$\frac{3}{8}$ "	50,0 mm

8794 B Zyklop wobble extension, $\frac{3}{8}$ "



Application: $\frac{3}{8}$ " square drive sockets with ball lock







Design: Swivels through 15°, chrome vanadium, brushed chrome-plated finish

		
05003584001	$\frac{3}{8}$ "	76,0 mm





Zyklop Ratchets, 1/2"

	Zyklop Speed	160
	Zyklop Hybrid Ratchet	164
	Zyklop Metal Push	166
	Zyklop Metal Switch	168
	Zyklop Accessories	170
	1/2" Koloss ratchet with hammer function	176



The Zyklop Speed Ratchets, 1/2"

5 types of ratchet in 1 tool

8100 SC 6 Zyklop Speed Ratchet Set, 1/2" drive, metric

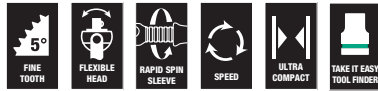

28-piece set; in a surface-preserving, compact and extremely robust textile box; low volume and weight for simplified mobility

1 Zyklop Speed Ratchet with 1/2" drive, 10 Zyklop sockets, 1 Zyklop extension (long) with free-turning sleeve, 1 wobble extension, 1 adaptor with quick-release chuck, 14 bits

05004076001		
⊖	8000 C	1 x 1/2"x277,0
⊙	8790 HMC	1 x 10,0x37,0; 1 x 11,0x37,0; 1 x 12,0x37,0; 1 x 13,0x37,0; 1 x 14,0x37,0; 1 x 15,0x37,0; 1 x 16,0x37,0; 1 x 17,0x37,0; 1 x 18,0x37,0; 1 x 19,0x37,0
⊖⊙	8794 LC	1 x 1/2"x250,0
⊖⊙	8794 C	1 x 1/2"x52,0
⊖⊙	8784 C2	1 x 5/16"x1/2"x50,0
+	851/2 Z PH	1 x PH 2x32; 1 x PH 3x32
+	855/2 Z PZ	1 x PZ 2x32; 1 x PZ 3x32
+	867/2 Z TORX®	1 x TX 20x35; 1 x TX 25x35; 1 x TX 30x35; 1 x TX 40x35; 1 x TX 45x35; 1 x TX 50x35
○	840/2 Z	1 x 5x30; 1 x 6x30; 1 x 8x30; 1 x 10x30

8100 SC 9 Zyklop Speed Ratchet Set, 1/2" drive, imperial

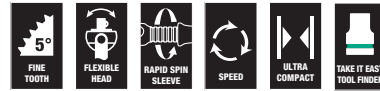

28-piece set; in a surface-preserving, compact and extremely robust textile box; low volume and weight for simplified mobility

1 Zyklop Speed Ratchet with 1/2" drive, 10 Zyklop sockets, 1 Zyklop extension (long) with free-turning sleeve, 1 wobble extension, 1 adaptor with quick-release chuck, 14 bits

05004079001		
⊖	8000 C	1 x 1/2"x277,0
⊙	8790 HMC	1 x 3/8"x37,0; 1 x 7/16"x37,0; 1 x 1/2"x37,0; 1 x 9/16"x37,0; 1 x 19/32"x37,0; 1 x 5/8"x37,0; 1 x 11/16"x37,0; 1 x 3/4"x37,0; 1 x 25/32"x37,0; 1 x 13/16"x37,0
⊖⊙	8794 LC	1 x 1/2"x250,0
⊖⊙	8794 C	1 x 1/2"x52,0
⊖⊙	8784 C2	1 x 5/16"x1/2"x50,0
+	851/2 Z PH	1 x PH 2x32; 1 x PH 3x32
+	855/2 Z PZ	1 x PZ 2x32; 1 x PZ 3x32
+	867/2 Z TORX®	1 x TX 20x35; 1 x TX 25x35; 1 x TX 30x35; 1 x TX 40x35; 1 x TX 45x35; 1 x TX 50x35
○	840/2 Z	1 x 7/32"x30; 1 x 1/4"x30; 1 x 5/16"x30; 1 x 3/8"x30

8100 SC 2 Zyklop Speed Ratchet Set, 1/2" drive, metric



37-piece set in strong metal case

1 Zyklop ratchet with 1/2" drive, 17 Zyklop sockets (metric),

2 Zyklop "flexible-lock" extensions (short and long) with free-tuning sleeve, 1 sliding T-handle, 1 universal joint, 1 wobble extension, 1 adaptor with quick-release chuck, 13 bits

05003645001	
8000 C	1 x 1/2"x277,0
8790 HMC	1 x 10,0x37,0; 1 x 11,0x37,0; 1 x 12,0x37,0; 1 x 13,0x37,0; 1 x 14,0x37,0; 1 x 15,0x37,0; 1 x 16,0x37,0; 1 x 17,0x37,0; 1 x 18,0x37,0; 1 x 19,0x37,0; 1 x 20,0x37,0; 1 x 21,0x37,0; 1 x 22,0x37,0; 1 x 24,0x37,0; 1 x 27,0x40,0; 1 x 30,0x42,0; 1 x 32,0x42,0
8789 C	1 x 1/2"x250,0
8794 C	1 x 1/2"x52,0
8795 C	1 x 1/2"x69,0
8784 C2	1 x 5/16"x1/2"x50,0
8796 SC	1 x 1/2"x125,0
8796 LC	1 x 1/2"x250,0
840/2 Z	1 x 5x30; 1 x 6x30; 1 x 8x30; 1 x 10x30
851/2 Z PH	1 x PH 3x32
855/2 Z PZ	1 x PZ 3x32
867/2 Z TORX®	1 x TX 20x35; 1 x TX 25x35; 1 x TX 30x35; 1 x TX 40x35; 1 x TX 45x35; 1 x TX 50x35; 1 x TX 55x35

Tip

Zyklop "6 in 1"



1. Fine-tooth ratchet
2. Flex-head ratchet
3. Angle ratchet
4. Quick-release ratchet
5. Power ratchet
6. Screwdriver

New set concept



The textile boxes offer dramatically improved portability, and are space-saving to boot! This means you can now carry the same collection of tools, in a much more compact and comfortable package.



The hassle of running back and forth for the right tools has now become a thing of the past. And the much lower weight of a set makes carrying more convenient than ever before. The textile box including the tool will even survive a fall undamaged.



"Take it easy"



"Take it easy" tool finder system – with profile and size colour-coding for quick and easy tool selection. Colour-coded system for hexagon drive screws (L-Keys, Zyklop bit sockets), external hex drive screws and nuts (Joker wrenches, Zyklop sockets and Zyklop bit sockets with holding function), and TORX® drive screws (L-Keys, Zyklop bit sockets).

The Zyklop Speed Ratchets, 1/2"

5 types of ratchet in 1 tool

8100 SC 4 Zyklop Speed Ratchet Set, 1/2" drive, imperial

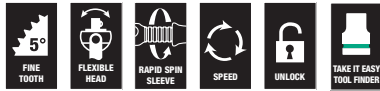

38-piece set in strong metal case

1 Zyklop ratchet with 1/2" drive, 18 Zyklop sockets (imperial),

2 Zyklop "flexible-lock" extensions (short and long) with free-tuning sleeve, 1 sliding T-handle, 1 universal joint, 1 wobble extension, 1 adaptor with quick-release chuck, 13 bits

05003647001		
⊙	8000 C	1 x 1/2"x277,0
⊙	8790 HMC	1 x 3/8"x37,0; 1 x 7/16"x37,0; 1 x 1/2"x37,0; 1 x 9/16"x37,0; 1 x 19/32"x37,0; 1 x 5/8"x37,0; 1 x 11/16"x37,0; 1 x 3/4"x37,0; 1 x 25/32"x37,0; 1 x 13/16"x37,0; 1 x 7/8"x37,0; 1 x 15/16"x37,0; 1 x 31/32"x37,0; 1 x 1"x40,0; 1 x 1 1/16"x40,0; 1 x 1 1/8"x40,0; 1 x 1 3/16"x42,0; 1 x 1 1/4"x42,0
⊙	8789 C	1 x 1/2"x250,0
⊙	8794 C	1 x 1/2"x52,0
⊙	8795 C	1 x 1/2"x69,0
⊙	8784 C2	1 x 5/16"x1/2"x50,0
⊙	8796 SC	1 x 1/2"x125,0
⊙	8796 LC	1 x 1/2"x250,0
+	851/2 Z PH	1 x PH 3x32
+	855/2 Z PZ	1 x PZ 3x32
⊙	867/2 Z TORX®	1 x TX 20x35; 1 x TX 25x35; 1 x TX 30x35; 1 x TX 40x35; 1 x TX 45x35; 1 x TX 50x35; 1 x TX 55x35
⊙	840/2 Z	1 x 7/32"x30; 1 x 1/4"x30; 1 x 5/16"x30; 1 x 3/8"x30

8000 C Zyklop Speed Ratchet with 1/2" drive



Application: 1/2" square drive sockets and 1/2" adapters with square drive, equipped with ball lock

Design: Flywheel design and easy-to-grip free-turning sleeve for faster work, swivel ratchet head, defined lock positions at 0° and 90° to the left and right as well as at 15° before 90° inwards, at 0° it can be used like a conventional screwdriver, pushbutton release, left/right switchover, fine-tooth design, small return angle of 5°

Handle: Multi-component Krafftform handle ensures minimum fatigue

		 mm
05003600001	1/2"	277,0

8000 C SB Zyklop Speed Ratchet with 1/2" drive

05073262001	1 x 1/2"x277,0	4013288 128058





The Zyklop Hybrid Ratchets, 1/2"

Combines robustness, slim design, and little weight

8006 SC 1 Zyklop Hybrid Ratchet Set, 1/2" drive, metric

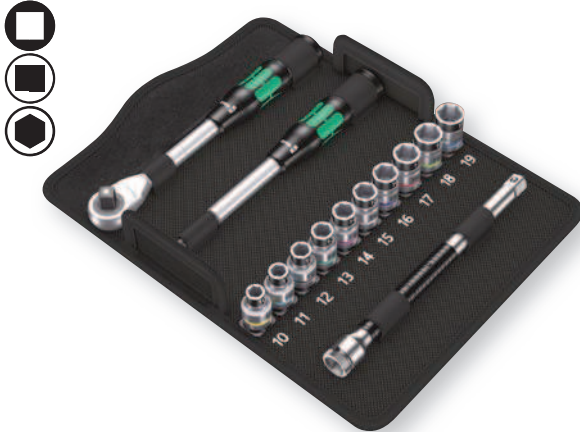

13-piece set; in a surface-preserving, compact and extremely robust textile box; low volume and weight for simplified mobility

1 Zyklop Hybrid Ratchet with 1/2" drive, 10 Zyklop sockets with holding function, 1 Zyklop Hybrid Extension with release pin, 1 Zyklop extension (long with free-turning sleeve)

05004090001	
○	8006 C 1 x 1/2"x281,0
○	8797 C 1 x 271,0
○	8794 LC 1 x 1/2"x250,0
●	8790 HMC HF 1 x 10,0x37,0; 1 x 11,0x37,0; 1 x 12,0x37,0; 1 x 13,0x37,0; 1 x 14,0x37,0; 1 x 15,0x37,0; 1 x 16,0x37,0; 1 x 17,0x37,0; 1 x 18,0x37,0; 1 x 19,0x37,0

Zyklop Hybrid Set



Application: Ratchet function for 1/2" square sockets and 1/2" adaptors with square drive, equipped with ball lock

Design: Fine-tooth mechanism with 72 teeth for a return angle of only 5°; switch lever for convenient change of direction; secure socket locking function

Handle: Multi-component Kraftform handle for optimum pressure, impact and tensile loads, handle end designed for connection of Zyklop Hybrid extension 8797 C

05004095001	
○	8006 C 1 x 1/2"x281,0
○	8797 C 1 x 271,0



8006 C Zyklop Hybrid Ratchet with switch lever and 1/2" drive



Application: 1/2" square sockets as well as for 1/2" adaptors with square drive, with ball locking device

Design: Fine-tooth mechanism with 72 teeth for a return angle of only 5°; switch lever for convenient change of direction; secure socket locking function

Handle: Multi-component Kraftform handle for optimum pressure and tensile loads, handle end designed for connection of Zyklop Hybrid extension

	mm	mm	mm	
05003780001	1/2"	281,0	34	37

8797 C Zyklop Hybrid extension



Application: Extension for use with Wera Zyklop Hybrid 8006 C to increase torque transfer

Design: Tough, tempered Cr-Mo steel

Handle: Multi-component Kraftform handle for optimum pressure and tensile loads; with extension release pin

	mm	mm
05003781001	134,0	137



Tip



“Take it easy”



“Take it easy” tool finder system – with profile and size colour-coding for quick and easy tool selection. Colour-coded system for hexagon drive screws (L-Keys, Zyklop bit sockets), external hex drive screws and nuts (Joker wrenches, Zyklop sockets and Zyklop bit sockets with holding function), and TORX® drive screws (L-Keys, Zyklop bit sockets).



Secure hold and easy removal



The all new smooth turning mechanism guarantees both secure and rattle-free storage, yet allows easy removal of the tool.

Sockets with retaining function for hexagon headed bolts, screws and nuts



The clamping of the screw is achieved by two flexible locking balls and a robust, permanently elastic, heat-shrunk tubing. The tubing is effectively protected against mechanical wear and tear by a steel ring. The holding function is especially helpful in confined, hard-to-reach spaces, where there is no room for a second hand to secure the screw.

The Zyklop Metal Ratchets Push, 1/2"

With push-through square

8100 SC 7 Zyklop Metal Ratchet Set with push-through square, 1/2" drive, metric

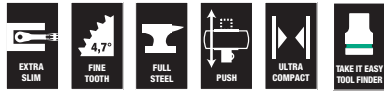

28-piece set; in a surface-preserving, compact and extremely robust textile box; low volume and weight for simplified mobility

1 Zyklop Metal Ratchet with push-through square and 1/2" drive, 10 Zyklop sockets, 1 Zyklop extension (long) with free-turning sleeve, 1 wobble extension, 1 adaptor with quick-release chuck, 14 bits

05004077001		
○	8003 C	1 x 1/2"x281,0
●	8790 HMC	1 x 10,0x37,0; 1 x 11,0x37,0; 1 x 12,0x37,0; 1 x 13,0x37,0; 1 x 14,0x37,0; 1 x 15,0x37,0; 1 x 16,0x37,0; 1 x 17,0x37,0; 1 x 18,0x37,0; 1 x 19,0x37,0
○	8794 LC	1 x 1/2"x250,0
○	8794 C	1 x 1/2"x52,0
○	8784 C2	1 x 5/16"x1/2"x50,0
+	851/2 Z PH	1 x PH 2x32; 1 x PH 3x32
+	867/2 Z TORX®	1 x TX 20x35; 1 x TX 25x35; 1 x TX 27x35; 1 x TX 30x35; 1 x TX 40x35; 1 x TX 45x35; 1 x TX 50x35; 1 x TX 55x35
○	840/2 Z	1 x 5x30; 1 x 6x30; 1 x 8x30; 1 x 10x30

8100 SC 10 Zyklop Metal Ratchet Set with push-through square, 1/2" drive, imperial

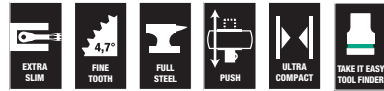

28-piece set; in a surface-preserving, compact and extremely robust textile box; low volume and weight for simplified mobility

1 Zyklop Metal Ratchet with push-through square and 1/2" drive, 10 Zyklop sockets, 1 Zyklop extension (long) with free-turning sleeve, 1 wobble extension, 1 adaptor with quick-release chuck, 14 bits





05004080001		
○	8003 C	1 x 1/2"x281,0
●	8790 HMC	1 x 3/8"x37,0; 1 x 7/16"x37,0; 1 x 1/2"x37,0; 1 x 9/16"x37,0; 1 x 19/32"x37,0; 1 x 5/8"x37,0; 1 x 11/16"x37,0; 1 x 3/4"x37,0; 1 x 25/32"x37,0; 1 x 13/16"x37,0
○	8794 LC	1 x 1/2"x250,0
○	8794 C	1 x 1/2"x52,0
○	8784 C2	1 x 5/16"x1/2"x50,0
+	851/2 Z PH	1 x PH 2x32; 1 x PH 3x32
+	867/2 Z TORX®	1 x TX 20x35; 1 x TX 25x35; 1 x TX 27x35; 1 x TX 30x35; 1 x TX 40x35; 1 x TX 45x35; 1 x TX 50x35; 1 x TX 55x35
○	840/2 Z	1 x 7/32"x30; 1 x 1/4"x30; 1 x 5/16"x30; 1 x 3/8"x30

8003 C Zyklop Metal Ratchet with push-through square and 1/2" drive



Application: 1/2" square sockets as well as for 1/2" adaptors with square drive, with ball locking device

Design: Forged, full metal ratchet (chrome-molybdenum) that is extremely robust with a long service life; slim design to enable work in very confined spaces; the dual-ratchet-teeth design means that a 76 fine-toothing division can be achieved from the 38 robust teeth with a return angle of only 4.7°; simple direction change with the undetachable push-through square and very secure socket lock mechanism

				
	mm	mm	mm	mm
05004063001	1/2"	281,0	36	37

Tip

The Zyklop Metal Ratchets Push



Forged, full metal ratchet (chrome-molybdenum) that is extremely robust with a long service life; slim design to enable work in very confined spaces.

Textile boxes



The textile boxes offer dramatically improved portability, and are space-saving to boot!

This means you can now carry the same collection of tools, in a much more compact and comfortable package. The hassle of running back and forth for the right tools has now become a thing of the past. And the much lower weight of a set makes carrying more convenient than ever before. The textile box including the tool will even survive a fall undamaged. And: it leaves absolutely no signs of scratches on sensitive surfaces.



TAKE IT EASY
TOOL FINDER

"Take it easy"



"Take it easy" tool finder system – with profile and size colour-coding for quick and easy tool selection. Colour-coded system for hexagon drive screws (L-Keys, Zyklop bit sockets), external hex drive screws and nuts (Joker wrenches, Zyklop sockets and Zyklop bit sockets with holding function), and TORX® drive screws (L-Keys, Zyklop bit sockets).

The Zyklop Metal Ratchets Switch, 1/2"

With switch lever

8100 SC 8 Zyklop Metal Ratchet Set with switch lever, 1/2" drive, metric



28-piece set; in a surface-preserving, compact and extremely robust textile box; low volume and weight for simplified mobility

1 Zyklop Metal Ratchet with switch lever and 1/2" drive, 10 Zyklop sockets, 1 Zyklop extension (long) with free-turning sleeve, 1 wobble extension, 1 adaptor with quick-release chuck, 14 bits

05004078001	
○	8004 C 1 x 1/2"x281,0
●	8790 HMC 1 x 10,0x37,0; 1 x 11,0x37,0; 1 x 12,0x37,0; 1 x 13,0x37,0; 1 x 14,0x37,0; 1 x 15,0x37,0; 1 x 16,0x37,0; 1 x 17,0x37,0; 1 x 18,0x37,0; 1 x 19,0x37,0
⊗	8794 LC 1 x 1/2"x250,0
⊗	8794 C 1 x 1/2"x52,0
⊗	8784 C2 1 x 5/16"x1/2"x50,0
+	851/2 Z PH 1 x PH 2x32; 1 x PH 3x32
+	867/2 Z TORX® 1 x TX 20x35; 1 x TX 25x35; 1 x TX 27x35; 1 x TX 30x35; 1 x TX 40x35; 1 x TX 45x35; 1 x TX 50x35; 1 x TX 55x35
○	840/2 Z 1 x 5x30; 1 x 6x30; 1 x 8x30; 1 x 10x30

8100 SC 11 Zyklop Metal Ratchet Set with switch lever, 1/2" drive, imperial



28-piece set; in a surface-preserving, compact and extremely robust textile box; low volume and weight for simplified mobility

1 Zyklop Metal Ratchet with switch lever and 1/2" drive, 10 Zyklop sockets, 1 Zyklop extension (long) with free-turning sleeve, 1 wobble extension, 1 adaptor with quick-release chuck, 14 bits

05004081001	
○	8004 C 1 x 1/2"x281,0
●	8790 HMC 1 x 3/8"x37,0; 1 x 7/16"x37,0; 1 x 1/2"x37,0; 1 x 9/16"x37,0; 1 x 19/32"x37,0; 1 x 5/8"x37,0; 1 x 11/16"x37,0; 1 x 3/4"x37,0; 1 x 25/32"x37,0; 1 x 13/16"x37,0
⊗	8794 LC 1 x 1/2"x250,0
⊗	8794 C 1 x 1/2"x52,0
⊗	8784 C2 1 x 5/16"x1/2"x50,0
+	851/2 Z PH 1 x PH 2x32; 1 x PH 3x32
+	867/2 Z TORX® 1 x TX 20x35; 1 x TX 25x35; 1 x TX 27x35; 1 x TX 30x35; 1 x TX 40x35; 1 x TX 45x35; 1 x TX 50x35; 1 x TX 55x35
○	840/2 Z 1 x 7/32"x30; 1 x 1/4"x30; 1 x 5/16"x30; 1 x 3/8"x30

8004 C Zyklop Metal Ratchet with switch lever and 1/2" drive



Application: 1/2" square sockets as well as for 1/2" adaptors with square drive, with ball locking device

Design: Forged, full metal ratchet (chrome-molybdenum) that is extremely robust with a long service life; slim design to enable work in very confined spaces; fine-tooth mechanism with 72 teeth for a return angle of only 5°; switch lever for convenient change of direction; secure socket locking function

05004064001	1/2"	281,0 mm	34 mm	37 mm

Tip

The Zyklop Metal Ratchets Switch



Extremely slim. Long leverage. Very robust without any torque limitation. Forged, full metal ratchet out of chrome molybdenum.

Textile boxes



The textile boxes offer dramatically improved portability, and are space-saving to boot!

This means you can now carry the same collection of tools, in a much more compact and comfortable package. The hassle of running back and forth for the right tools has now become a thing of the past. And the much lower weight of a set makes carrying more convenient than ever before. The textile box including the tool will even survive a fall undamaged. And: it leaves absolutely no signs of scratches on sensitive surfaces.



“Take it easy”



“Take it easy” tool finder system – with profile and size colour-coding for quick and easy tool selection. Colour-coded system for hexagon drive screws (L-Keys, Zyklop bit sockets), external hex drive screws and nuts (Joker wrenches, Zyklop sockets and Zyklop bit sockets with holding function), and TORX® drive screws (L-Keys, Zyklop bit sockets).

Zyklop Accessories, 1/2"

The perfect add-on for all Zyklop ratchets

HMC Zyklop socket with 1/2" drive



Application: Hexagon headed bolts, screws and nuts

Design: Manual and (non-impact) machine applications, ball intercept ring, knurls at base for precision handling in manual operations, chrome vanadium, brushed chrome-plated finish. Colour coding to enable the desired bit socket to be easily located

	mm	mm	mm	mm	mm	mm
05003601001	10,0	37,0	15,5	24,0	17,0	
05003602001	11,0	37,0	16,5	24,0	17,0	
05003603001	12,0	37,0	17,5	24,0	17,0	
05003604001	13,0	37,0	19,0	24,0	17,0	
05003605001	14,0	37,0	20,0	24,0	17,0	
05003606001	15,0	37,0	21,0	24,0	17,0	
05003607001	16,0	37,0	22,5	24,0	17,0	
05003608001	17,0	37,0	24,0	26,0	17,0	
05003609001	18,0	37,0	25,0	26,0	17,0	
05003610001	19,0	37,0	26,5	26,0	20,0	
05003611001	20,0	37,0	28,0	26,0	20,0	
05003612001	21,0	37,0	29,0	26,0	20,0	
05003613001	22,0	37,0	30,5	26,0	20,0	
05003614001	24,0	37,0	33,0	28,0	20,0	
05003615001	27,0	40,0	36,5	32,0	23,0	
05003616001	30,0	42,0	40,0	34,0	25,0	
05003617001	32,0	42,0	42,0	36,0	25,0	
05003618001	3/8"	37,0	15,5	24,0	17,0	
05003619001	7/16"	37,0	16,5	24,0	17,0	
05003620001	1/2"	37,0	19,0	24,0	17,0	
05003621001	9/16"	37,0	20,0	24,0	17,0	
05003622001	19/32"	37,0	21,0	24,0	17,0	
05003623001	5/8"	37,0	22,5	24,0	17,0	
05003624001	11/16"	37,0	25,5	26,0	17,0	
05003625001	3/4"	37,0	26,5	26,0	20,0	
05003626001	25/32"	37,0	28,0	26,0	20,0	
05003627001	13/16"	37,0	29,0	26,0	20,0	
05003628001	7/8"	37,0	30,5	26,0	20,0	
05003629001	15/16"	37,0	33,0	28,0	20,0	
05003630001	31/32"	37,0	33,0	28,0	20,0	
05003631001	1"	40,0	36,5	32,0	23,0	
05003632001	1 1/16"	40,0	36,5	32,0	23,0	
05003633001	1 1/8"	40,0	40,0	34,0	23,0	
05003634001	1 3/16"	42,0	40,0	34,0	25,0	
05003635001	1 1/4"	42,0	42,0	36,0	25,0	

8790 HMC HF Zyklop socket with 1/2" drive with holding function



Application: Hexagon headed bolts, screws and nuts

Design: Manual and (non-impact) machine applications, ball intercept ring, knurls at base for precision handling in manual operations, with holding function, chrome vanadium, brushed chrome-plated finish. Colour coding to enable the desired bit socket to be easily located

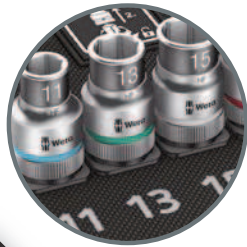

	mm	mm	mm	mm	mm	mm
05003730001	10,0	37,0	17,8	23,5	10,4	
05003731001	11,0	37,0	18,8	23,5	10,4	
05003732001	12,0	37,0	20,4	23,5	11,4	
05003733001	13,0	37,0	21,4	23,5	11,4	
05003734001	14,0	37,0	22,6	23,5	11,4	
05003735001	15,0	37,0	23,6	23,5	12,0	
05003736001	16,0	37,0	25,0	23,5	12,0	
05003737001	17,0	37,0	26,8	23,5	12,5	
05003738001	18,0	37,0	28,0	23,5	12,5	
05003739001	19,0	37,0	29,2	23,5	14,0	

8790 HF 1 Zyklop socket set with holding function



10-piece set; in a surface-preserving, compact and extremely robust textile box; low volume and weight for simplified mobility

10 Zyklop sockets with 1/2" drive with holding function

	
05004203001	
	8790 HMC HF 1 x 10,0x37,0; 1 x 11,0x37,0; 1 x 12,0x37,0; 1 x 13,0x37,0; 1 x 14,0x37,0; 1 x 15,0x37,0; 1 x 16,0x37,0; 1 x 17,0x37,0; 1 x 18,0x37,0; 1 x 19,0x37,0

Tip

Sockets with retaining function for hexagon headed bolts, screws and nuts



The clamping of the screw is achieved by two flexible locking balls and a robust, permanently elastic, heat-shrunk tubing. The tubing is effectively protected against mechanical wear and tear by a steel ring. The holding function is especially helpful in confined, hard-to-reach spaces, where there is no room for a second hand to secure the screw.



"Take it easy"



"Take it easy" tool finder system – with profile and size colour-coding for quick and easy tool selection. Colour-coded system for hexagon drive screws (L-Keys, Zyklop bit sockets), external hex drive screws and nuts (Joker wrenches, Zyklop sockets and Zyklop bit sockets with holding function), and TORX® drive screws (L-Keys, Zyklop bit sockets).



Secure hold and easy removal



The all new smooth turning mechanism of the Zyklop HF Socket sets guarantees both secure and rattle-free storage, yet allows easy removal of the tool.

Zyklop Accessories, 1/2"

The perfect add-on for all Zyklop ratchets

8767 C HF TORX® Zyklop bit socket with 1/2" drive with holding function

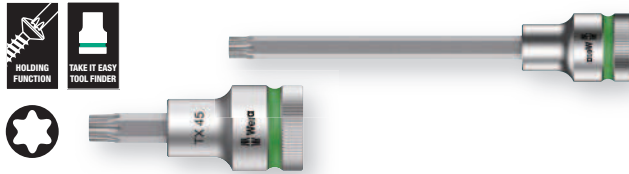

Application: TORX® socket screws

Design: Manual and (non-impact) machine applications, ball intercept ring, knurls at base for precision handling in manual operations, chrome vanadium, brushed chrome-plated finish, holding function for TORX® screws made according to Acument Intellectual Properties specifications. Take it easy tool finder: Colour coding to enable the desired bit socket to be easily located

			mm	mm	mm	mm
05003830001		TX 20	60,0	16,4	23,5	21,5
05003850001		TX 20	140,0	16,4	23,5	101,5
05003831001		TX 25	60,0	16,4	23,5	21,5
05003851001		TX 25	140,0	16,4	23,5	101,5
05003832001		TX 27	60,0	16,4	23,5	21,5
05003852001		TX 27	140,0	16,4	23,5	101,5
05003833001		TX 30	60,0	16,4	23,5	21,5
05003853001		TX 30	140,0	16,4	23,5	101,5
05003834001		TX 40	60,0	16,4	23,5	21,5
05003854001		TX 40	140,0	16,4	23,5	101,5
05003835001		TX 45	60,0	16,4	23,5	21,5
05003855001		TX 45	140,0	16,4	23,5	101,5
05003836001		TX 50	60,0	21,4	23,5	21,5
05003856001		TX 50	140,0	21,4	23,5	101,5
05003837001		TX 55	60,0	21,4	23,5	21,5
05003857001		TX 55	140,0	21,4	23,5	101,5
05003838001		TX 60	60,0	21,4	23,5	21,5
05003858001		TX 60	140,0	21,4	23,5	101,5

8767 C TORX® HF 1 Zyklop bit socket set with 1/2" drive, with holding function



9-piece set; in a surface-preserving, compact and extremely robust textile box; low volume and weight for simplified mobility

9 Zyklop bit sockets for TORX® screws, with 1/2" drive, with holding function

05004202001			
	8767 C HF	1 x TX 20x60; 1 x TX 25x60; 1 x TX 27x60;	
		1 x TX 30x60; 1 x TX 40x60; 1 x TX 45x60;	
		1 x TX 50x60; 1 x TX 55x60; 1 x TX 60x60	

8740 C HF Zyklop bit socket with 1/2" drive with holding function

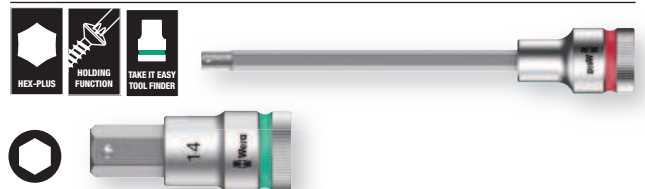

Application: Hexagon socket screws

Design: Manual and (non-impact) machine applications, ball intercept ring, knurls at base for precision handling in manual operations, chrome vanadium, brushed chrome-plated finish, holding function for hexagon socket screws. Colour coding to enable the desired bit socket to be easily located

		mm	mm	mm	mm	mm
05003820001		4,0	60,0	14,0	21,5	21,5
05003840001		4,0	140,0	14,0	21,5	101,5
05003821001		5,0	60,0	14,0	21,5	21,5
05003841001		5,0	140,0	14,0	21,5	101,5
05003822001		6,0	60,0	14,0	21,5	21,5
05003842001		6,0	140,0	14,0	21,5	101,5
05003823001		7,0	60,0	14,0	23,5	21,5
05003843001		7,0	140,0	14,0	23,5	101,5
05003824001		8,0	60,0	16,0	23,5	21,5
05003844001		8,0	140,0	16,0	23,5	101,5
05003825001		10,0	60,0	16,0	23,5	21,5
05003845001		10,0	140,0	16,0	23,5	101,5
05003826001		12,0	60,0	21,0	23,5	23,0
05003827001		14,0	60,0	22,0	23,5	23,0
05003828001		17,0	60,0	24,5	25,5	23,0
05003829001		19,0	60,0	26,5	27,5	23,0

8740 C HF 1 Zyklop bit socket set with 1/2" drive with holding function



9-piece set; in a surface-preserving, compact and extremely robust textile box; low volume and weight for simplified mobility

9 Zyklop bit sockets for hexagon socket screws, with 1/2" drive, with holding function

05004201001	
	8740 C HF 1 x 4,0x60,0; 1 x 5,0x60,0; 1 x 6,0x60,0; 1 x 7,0x60,0; 1 x 8,0x60,0; 1 x 10,0x60,0; 1 x 12,0x60,0; 1 x 14,0x60,0; 1 x 17,0x60,0

8796 SC Zyklop „flexible-lock“ extension with free-turning sleeve, short, 1/2"



Application: 1/2" square drive sockets with ball lock

Design: Flexible lock system either for permanent interlocking or fast change of accessories, free-turning sleeve for rapid tightening or loosening of screws and nuts, chrome vanadium, brushed chrome-plated finish

	mm
05003642001	1/2" 125,0

Tip

Bit sockets with holding function for TORX® screws



The HF tools developed by Wera are ideal because they feature an optimised geometry of the original TORX® profile. The wedging forces resulting from the surface pressure between the drive tip and the screw profile mean that TORX® screws made according to Acument Intellectual Properties specifications are securely held on the tool!

Bit sockets with retaining function for hexagon socket screws



The clamping of the screw is achieved by a flexible locking ball. The holding function is especially helpful in confined, hard-to-reach spaces, where there is no room for a second hand to secure the screw.



Secure hold and easy removal



The all new smooth turning mechanism of the Zyklop HF socket sets guarantees both secure and rattle-free storage, yet allows easy removal of the tool.

Zyklop Accessories, 1/2"

The perfect add-on for all Zyklop ratchets

8796 LC Zyklop "flexible-lock" extension with free-turning sleeve, long, 1/2"



Application: 1/2" square drive sockets with ball lock

Design: Flexible lock system either for permanent interlocking or fast change of accessories, free-turning sleeve for rapid tightening or loosening of screws and nuts, chrome vanadium, brushed chrome-plated finish

		mm
05003643001	1/2"	250,0

8794 LC Zyklop extension with free-turning sleeve, long, 1/2"



Application: 1/2" square drive sockets with ball lock

Design: Easy-to-grip free-turning sleeve for rapid tightening or loosening of screws and nuts, chrome vanadium, brushed chrome-plated finish

		mm
05003638001	1/2"	250,0

8794 SC Zyklop extension with free-turning sleeve, short, 1/2"



Application: 1/2" square drive sockets with ball lock

Design: Easy-to-grip free-turning sleeve for rapid tightening or loosening of screws and nuts, chrome vanadium, brushed chrome-plated finish

		mm
05003637001	1/2"	125,0

8789 C Zyklop sliding T-handle, 1/2"



Application: 1/2" square drive sockets with ball lock

Design: Sliding drive, chrome vanadium, brushed chrome-plated finish



		mm
05003636001	1/2"	250,0

8795 C Zyklop universal joint, 1/2"



Application: 1/2" square drive sockets with ball lock

Design: Chrome vanadium/chrome molybdenum, brushed chrome-plated finish





	
	 mm
05003640001	1/2" 69,0

8784 C2 Zyklop Bit adaptor, 1/2", 5/16"



Application: Suitable for 5/16" hex bits as per DIN ISO 1173-C 8 and Wera series 2

Design: Quick-release chuck for fast bit changes, chromium vanadium

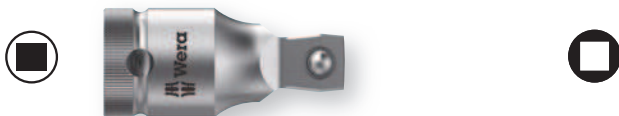

	
 	 mm
05003641001	5/16" 1/2" 50,0

8794 C Zyklop wobble extension, 1/2"



Application: 1/2" square drive sockets with ball lock

Design: Swivels through 15°, chrome vanadium, brushed chrome-plated finish

	
	 mm
05003639001	1/2" 52,0

The Koloss

Obviously, many users also apply their ratchet as a hammer. This often ruins the ratchet and is dangerous to boot.

That is why we developed the heavy-duty Koloss ratchet whose mechanism is extremely robust, and nearly impossible to destroy through impact.

The Koloss is so robust that it can even be used safely with its extension element.



Non-removable sealed and hardened square drive for tough jobs.



Changing the ratchet direction using a hardened push-through square drive ensures great resilience, since there is no susceptible switching mechanism that could be damaged by hammer blows. This is far more robust than a forward/reverse switch.



Tubular shaft minimises impact vibrations.

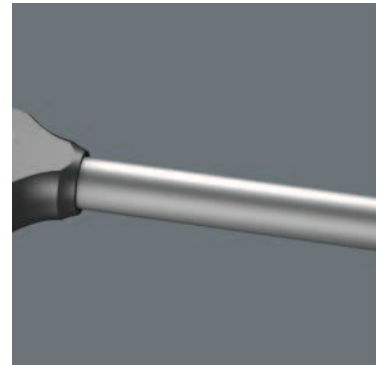

Dry-fined hammer face: used with rubber pad attachments to protect materials and surfaces.



The drop-forged hammer head is permanently pinned to the shaft in a form-fit joint. This guarantees an almost non-detachable positioning of the hammer head on the handle.



Dual ratchet teeth: gives the robust 30 saw teeth the precision engineering effect of 60 fine teeth with a 6° return angle.



Newly developed, multi-component Kraftform handle that satisfies both the hammer and ratchet application requirements.



Sockets and accessories can simply and quickly be attached.



The degree of torque applied can be increased by using the Wera extension Koloss 8002 C.

Koloss

This ratchet is a real hit! And that is for sure!

8002 C Koloss All Inclusive Set with 1/2" drive



Application: Ratchet function for 1/2" square sockets and 1/2" adaptors with square drive, equipped with ball lock, hammer function e.g. to align work pieces

Design: Push-through square drive for forward and reverse operation, fine-tooth ratchet mechanism, small return angle of 6°, can transfer at least 600 Nm of torque, tubular shaft to minimise impact vibrations, drop-forged hammer head, positively pinned, ground striking face

Handle: Multi-component Krafftform handle for optimum pressure, impact and tensile loads, handle end designed for connection of Koloss extension 8780 C and Koloss centering pin 8781 C

05133862001		
	8002 C	1 x 1/2"x341,0
	8782 C	1 x 2x50,0
	8780 C	1 x 341,0x137
	8000 E	1 x Extension release pin
	8000 HLF	1 x Holster



” To learn more about this product, scan the QR code. “

8002 C Koloss 1/2" with 1/2" drive



Application: Ratchet function for 1/2" square sockets and 1/2" adaptors with square drive, equipped with ball lock, hammer function e.g. to align work pieces

Design: Push-through square drive for forward and reverse operation, fine-tooth ratchet mechanism, small return angle of 6°, can transfer at least 600 Nm of torque, tubular shaft to minimise impact vibrations, drop-forged hammer head, positively pinned, ground striking face

Handle: Multi-component Krafftform handle for optimum pressure, impact and tensile loads, handle end designed for connection of Koloss extension 8780 C and Koloss centering pin 8781 C

05003692001		
	8002 C	1 x 1/2"x341,0
	8782 C	1 x 2x50,0
	8000 HLF	1 x Holster

8780 C Koloss extension



Application: Extension for use with Wera Koloss 8002 C to increase torque transfer

Design: Tough, tempered Cr-Mo steel

Handle: Multi-component Krafftform handle for optimum pressure, impact and tensile loads, laser-engraved safety instructions for permanent recognition

	⌀	⌀
	mm	mm
05003695001	341,0	137

8781 C Koloss centring pin



Application: Centering pin for use with Wera Koloss 8002 C to align lugs or drill holes

Design: Tapered pin out of tough, tempered Cr-Mo steel

	\varnothing^+ mm	\varnothing^+ mm
05003696001	85	135,0

8782 C Koloss pad set



Application: Protective attachment for striking faces for use with Wera Koloss 8002 C to protect materials and surfaces

Design: Flexible, thermoplastic elastomer material for lasting elasticity and maximum protection

	#	 mm
05003697001	2	50,0

Tip

Dry-fined hammer face



Dry-fined hammer face: used with rubber pad attachments to protect materials and surfaces.

Why do the dual ratchet teeth provide particular robustness?



Dual ratchet teeth: gives the robust 30 saw teeth the precision engineering effect of 60 fine teeth with a 6° return angle.

Who is the Koloss suitable for?



Basically anyone who would like to work with a ½" ratchet. Typical fields of application are mechanical engineering, boatbuilding, mining, aircraft construction, bridge building, commercial vehicle construction and maintenance, railway and road construction and maintenance, industrial plant and equipment construction, high-bay

warehouse construction, petroleum industry and many more.

Zyklop Mini

Combines elegant design with incredible resilience. Suitable for rapid fastening even in confined working situations. The Wera Zyklop Mini is applied whenever fastening with a power tool or conventional tools is impossible due to insufficient space.

The Zyklop Mini 1 for the direct attachment of bits; the Zyklop Mini 2 for the direct attachment of the special Wera Zyklop sockets.



The fine tooth mechanism, with its 60 teeth, allows a small return angle of only 6° – ideal for precision work.



Thumbwheel enables rapid screw-driving, even when there isn't sufficient room for ratcheting use.



Simple switching between left/right operations.



Its slim design makes it ideal for all particularly confined working situations.

Zyklop Mini

For confined spaces

Bit-Check 30 Zyklop Mini 1



28 bits, 1 Rapidaptor bit holder, 1 adaptor 870/1 (1/4" hexagon to 1/4" square), 1 Wera Bit Ratchet, drop-forged full steel design, suitable for 1/4" hex bits as per DIN ISO 1173-C 6,3 and E 6,3 and Wera series 1 and 4

05073640001		
	8001 A	1 x 1/4"x87,0
⊙	870/1	1 x 1/4"x25
⊙	889/4/1 K	1 x 1/4"x50
+	851/1 TZ PH	2 x PH 1x25; 3 x PH 2x25; 1 x PH 3x25
+	855/1 TH PZ	1 x PZ 1x25; 3 x PZ 2x25; 1 x PZ 3x25
⊕	867/1 TZ TORX®	1 x TX 10x25; 1 x TX 15x25; 1 x TX 20x25; 1 x TX 25x25; 1 x TX 30x25; 1 x TX 40x25
⊕	867/1 Z TORX®	1 x TX 10x25; 1 x TX 15x25; 1 x TX 20x25; 1 x TX 25x25; 1 x TX 30x25
⊖	800/1 TZ	1 x 1,0x5,5x25
○	840/1 Z Hex-Plus	1 x 3,0x25; 1 x 4,0x25; 1 x 5,0x25; 1 x 6,0x25; 1 x 8,0x25

Bit-Check 30 Zyklop Mini 2



28 bits, 1 Rapidaptor bit holder, 1 adaptor 870/1 (1/4" hexagon to 1/4" square), 1 Wera Bit Ratchet, drop-forged full steel design, suitable for 1/4" hex bits as per DIN ISO 1173-C 6,3 and E 6,3 and Wera series 1 and 4

05346293001		
	8001 A	1 x 1/4"x87,0
⊙	870/1	1 x 1/4"x25
⊙	889/4/1 K	1 x 1/4"x50
+	851/1 TZ PH	2 x PH 1x25; 3 x PH 2x25; 1 x PH 3x25
⊕	867/1 TZ TORX®	1 x TX 10x25; 1 x TX 15x25; 1 x TX 20x25; 1 x TX 25x25; 1 x TX 30x25; 1 x TX 40x25
⊕	867/1 Z TORX®	1 x TX 10x25; 1 x TX 15x25; 1 x TX 20x25; 1 x TX 25x25; 1 x TX 30x25
⊖	800/1 TZ	1 x 1,0x5,5x25
○	840/1 Z Hex-Plus	1 x 3/32"x25; 1 x 1/8"x25; 1 x 5/32"x25; 1 x 3/16"x25; 1 x 1/4"x25
○	868/1 Z	1 x # 1x25; 3 x # 2x25; 1 x # 3x25

Kraftform Kompakt Zyklop Mini 2



1 Wera Bit Ratchet Zyklop Mini 1, drop-forged full steel design, suitable for 1/4" hex bits as per DIN ISO 1173-C 6,3 and E 6,3 and Wera series 1 and 4. Can also be used with 1/4" sockets by using the Wera socket adaptor 870/1. 1 Wera Ratchet Zyklop Mini 2, drop-forged full steel design, suitable for for Wera sockets 8790 FA. 9 Wera sockets 8790 FA, 1 socket adaptor 870/1, 14 bits, tough, for universal use

	
05135918001	
	8001 A 1 x 1/4"x87,0
	8005 1 x 107
●	813 1 x 1/4"x78
⊕	870/1 1 x 1/4"x25
⊕	851/1 Z PH 1 x PH 1x25; 1 x PH 2x25
⊕	855/1 Z PZ 1 x PZ 1x25; 1 x PZ 2x25
⊕	867/1 TORX® 1 x TX 10x25; 1 x TX 15x25; 1 x TX 20x25; 1 x TX 25x25; 1 x TX 30x25; 1 x TX 40x25
⊕	840/1 Z Hex-Plus 1 x 3,0x25; 1 x 4,0x25; 1 x 5,0x25; 1 x 6,0x25
	8790 FA 1 x 4,0; 1 x 5,0; 1 x 5,5; 1 x 6,0; 1 x 7,0; 1 x 8,0; 1 x 10,0; 1 x 12,0; 1 x 13,0

Tip

Zyklop Mini tool sets



Available in a set with the dependable Wera Bit-Check with socket adaptor and belt clip. Simple fitting and removal of tools. Very robust and a long service life.

Bit-Check as a lever



The Bit-Check itself can be used as a lever.

Zyklop Mini 2



The Zyklop Mini 2 is suitable for the direct attachment of the special Wera Zyklop sockets 8790 FA. These sockets feature a very low height, ideal for confined working spaces.

Zyklop Mini

For confined spaces

Tool-Check PLUS



28 bits, 1 hand holder 813 suitable for the attachment of bits with 1/4" hexagon drive as per DIN ISO 1173-C 6,3 and Wera connection series 1, 1 Rapidaptor bit holder, 1 adaptor 870/1 (1/4" hexagon to 1/4" square), 7 sockets (1/4"); 1 Wera Bit Ratchet, drop-forged full steel design suitable for the attachment of bits with 1/4" hexagon drive as per DIN ISO 1173-C 6,3 and E 6,3 and Wera connection series 1 and 4; the use of 1/4" sockets is also possible with the application of the Wera adaptor 870/1

05056490001		
●	8001 A	1 x 1/4"x87,0
●	813	1 x 1/4"x78
●○	889/4/1 K	1 x 1/4"x50
○○	870/1	1 x 1/4"x25
●	8790 HMA	1 x 5,5x23,0; 1 x 6,0x23,0; 1 x 7,0x23,0; 1 x 8,0x23,0; 1 x 10,0x23,0; 1 x 12,0x23,0; 1 x 13,0x23,0
⊕	851/1 TZ PH	2 x PH 1x25; 3 x PH 2x25; 1 x PH 3x25
⊕	855/1 TH PZ	1 x PZ 1x25; 3 x PZ 2x25; 1 x PZ 3x25
⊕	867/1 TZ TORX®	1 x TX 10x25; 1 x TX 15x25; 1 x TX 20x25; 1 x TX 25x25; 1 x TX 30x25; 1 x TX 40x25
⊕	867/1 Z TORX® B0	1 x TX 10x25; 1 x TX 15x25; 1 x TX 20x25; 1 x TX 25x25; 1 x TX 30x25
○	840/1 Z Hex-Plus	1 x 3,0x25; 1 x 4,0x25; 1 x 5,0x25; 1 x 6,0x25; 1 x 8,0x25
◐	800/1 TZ	1 x 1,0x5,5x25

Tool-Check PLUS Imperial



28 bits, 1 hand holder 813 suitable for the attachment of bits with 1/4" hexagon drive as per DIN ISO 1173-C 6,3 and Wera connection series 1, 1 Rapidaptor bit holder, 1 adaptor 870/1 (1/4" hexagon to 1/4" square), 7 sockets (1/4"); 1 Wera Bit Ratchet, drop-forged full steel design suitable for the attachment of bits with 1/4" hexagon drive as per DIN ISO 1173-C 6,3 and E 6,3 and Wera connection series 1 and 4; the use of 1/4" sockets is also possible with the application of the Wera adaptor 870/1

05056491001		
●	8001 A	1 x 1/4"x87,0
●	813	1 x 1/4"x78
●○	889/4/1 K	1 x 1/4"x50
○○	870/1	1 x 1/4"x25
●	8790 HMA	1 x 3/16"x23,0; 1 x 1/4"x23,0; 1 x 5/16"x23,0; 1 x 11/32"x23,0; 1 x 3/8"x23,0; 1 x 7/16"x23,0; 1 x 1/2"x23,0
⊕	851/1 TZ PH	2 x PH 1x25; 3 x PH 2x25; 1 x PH 3x25
◐	800/1 TZ	1 x 1,0x5,5x25
⊕	867/1 TZ TORX®	1 x TX 10x25; 1 x TX 15x25; 1 x TX 20x25; 1 x TX 25x25; 1 x TX 30x25; 1 x TX 40x25
⊕	867/1 Z TORX® B0	1 x TX 10x25; 1 x TX 15x25; 1 x TX 20x25; 1 x TX 25x25; 1 x TX 30x25
○	840/1 Z Hex-Plus	1 x 3/32"x25; 1 x 1/8"x25; 1 x 5/32"x25; 1 x 3/16"x25; 1 x 5/16"x25
○	868/1 V	1 x # 1x25; 3 x # 2x25; 1 x # 3x25



” To learn more about this product, scan the QR code. “

Tool-Check 1 SB



28 bits; 1 socket adaptor 870/1 (1/4" hexagonal to 1/4" square); 7 manual & power tool sockets; 1 Rapidaptor bit holder; 1 Wera Bit Ratchet, with drop-forged steel design suitable for the fitting of bits with 1/4" hexagonal headed drive as per DIN ISO 1173-C 6,3 and E 6,3, i.e. Wera Series 1 and 4. Can also be used with 1/4" sockets by using the socket adaptor (870/1).

05073220001	
	8001 A 1 x 1/4"x87,0
⊕	870/1 1 x 1/4"x25
⊙	889/4/1 K 1 x 1/4"x50
+	851/1 TZ PH 2 x PH 1x25; 3 x PH 2x25; 1 x PH 3x25
+	855/1 TH PZ 1 x PZ 1x25; 3 x PZ 2x25; 1 x PZ 3x25
⊗	867/1 TZ 1 x TX 10x25; 1 x TX 15x25; 1 x TX 20x25; TORX® 1 x TX 25x25; 1 x TX 30x25; 1 x TX 40x25
⊗	867/1 Z TORX® 1 x TX 10x25; 1 x TX 15x25; 1 x TX 20x25; B0 1 x TX 25x25; 1 x TX 30x25
⊖	800/1 TZ 1 x 1,0x5,5x25
○	840/1 Z 1 x 3,0x25; 1 x 4,0x25; 1 x 5,0x25; 1 x 6,0x25; Hex-Plus 1 x 8,0x25
⊙	8790 HMA 1 x 5,5x23,0; 1 x 6,0x23,0; 1 x 7,0x23,0; 1 x 8,0x23,0; 1 x 10,0x23,0; 1 x 12,0x23,0; 1 x 13,0x23,0

Tip

What parts can be connected to the Zyklop Mini 1?



Bits and sockets. Bits can be connected directly. However, a holder can be connected first and then the bit can be attached to this. This then serves as an extension with a free-turning sleeve. An adaptor e.g. Wera 870/1 is needed for sockets – 1/4" hexagonal on a square drive (included in the Bit-Check and with the individual Zyklop Mini 1 in the set).

When is the Zyklop Mini 1 needed?



Particularly when the space is confined and there is not much room for the tool.

Is rapid screwdriving possible with the Zyklop Mini?



High working speeds can be attained with the Zyklop Mini. The thumb wheel is important, enabling more rapid screwdriving, and the Zyklop Mini handle only needs to be used for the final tightening of the screw.



"Take it easy"



"Take it easy" tool finder system – with profile and size colour-coding for quick and easy tool selection. Colour-coded system for hexagon drive screws (L-Keys, Zyklop bit sockets), external hex drive screws and nuts (Joker wrenches, Zyklop sockets and Zyklop bit sockets with holding function), and TORX® drive screws (L-Keys, Zyklop bit sockets).

Zyklop Mini

For confined spaces

Tool-Check Automotive 1



28 bits; 1 870/1 socket adaptor (1/4" hexagonal to 1/4" square); 7 manual & power tool sockets; 1 Rapidaptor bit holder; 1 Wera Bit Ratchet, with drop-forged steel design suitable for the fitting of bits with 1/4" hexagonal headed drive as per DIN ISO 1173-C 6,3 and E 6,3, i.e. Wera Series 1 and 4. Can also be used with 1/4" sockets by using the socket adaptor (870/1).

05200995001		
	8001 A	1 x 1/4"x87,0
⊙	870/1	1 x 1/4"x25
⊙	889/4/1 K	1 x 1/4"x50
+	851/1 TZ PH	1 x PH 1x25; 1 x PH 2x25; 1 x PH 3x25
+	867/1 TZ TORX®	1 x TX 10x25; 1 x TX 15x25; 1 x TX 20x25; 1 x TX 25x25; 1 x TX 30x25; 1 x TX 40x25
+	867/1 Z TORX® B0	1 x TX 10x25; 1 x TX 15x25; 1 x TX 20x25; 1 x TX 25x25; 1 x TX 30x25
●	800/1 TZ	1 x 1,0x5,5x25
○	840/1 Z Hex-Plus	1 x 3,0x25; 1 x 4,0x25; 1 x 5,0x25; 1 x 6,0x25; 1 x 8,0x25
○	860/1 XZN Vielzahn	1 x M 4x25; 1 x M 5x25; 1 x M 6x25; 1 x M 8x25
+	873/1 Five Lobe	1 x 20x25; 1 x 25x25; 1 x 27x25; 1 x 30x25
●	8790 HMA	1 x 5,5x23,0; 1 x 6,0x23,0; 1 x 7,0x23,0; 1 x 8,0x23,0; 1 x 10,0x23,0; 1 x 12,0x23,0; 1 x 13,0x23,0



” To learn more about this product, scan the QR code. “

Kraftform Kompakt Zyklop Mini 1



9 bits, tough, for universal use, 1 Wera Bit Ratchet Zyklop Mini 1, drop-forged full steel design, suitable for 1/4" hex bits as per DIN ISO 1173-C 6,3 and E 6,3 and Wera series 1 and 4. Can also be used with 1/4" sockets by using the Wera socket adaptor 870/1.

05073645001		
	8001 A	1 x 1/4"x87,0
+	851/1 Z PH	1 x PH 1x25; 1 x PH 2x25
+	855/1 Z PZ	1 x PZ 1x25; 1 x PZ 2x25
+	867/1 TORX®	1 x TX 15x25; 1 x TX 20x25; 1 x TX 25x25
○	840/1 Z Hex-Plus	1 x 4,0x25; 1 x 5,0x25

8001 A Zyklop Mini 1 Bit Ratchet 1/4" SB with 1/4" drive



Application: Suitable for 1/4" hex bits as per DIN ISO 1173-C 6,3 and E 6,3 and Wera series 1 and 4, Wera adaptor 870/1 for 1/4" sockets

Design: Drop-forged full steel design, fine-tooth ratchet mechanism, small return angle of 6°, forward and reverse drive switch

Handle: Kraftform handle with proven Kraftform geometry provides perfectly designed finger contact zones, ergonomic ratchet head and handle

05073230001		
	8001 A	1 x 1/4"x87,0
⊙	870/1	1 x 1/4"x25

Zyklop Mini 2



Application: Suitable for Wera sockets 8790 FA

Design: Drop-forged full steel design, fine-tooth ratchet mechanism, small return angle of 6°, forward and reverse drive switch

Handle: Kraftform handle with proven Kraftform geometry provides perfectly designed finger contact zones, ergonomic ratchet head and handle

	
	mm
05003660001	107





8790 FA Zyklop socket with 1/4" and Hexagon 11 drive



Application: Hexagon headed bolts, screws and nuts

Design: 1/4" external square and hexagon size; suitable for 1/4" ratchets and Wera Zyklop Mini 2 ratchet

Handle: Manual applications; ball intercept ring; extremely low height, ideal for confined spaces; chrome vanadium, chrome-plated

					
	mm	mm	mm	mm	mm
05003665001	4,0	11,8	9,5	18,0	6,4
05003666001	4,5	11,8	9,5	18,0	7,0
05003667001	5,0	11,8	9,5	18,0	7,6
05003668001	5,5	11,8	9,5	18,0	8,2
05003669001	6,0	11,8	9,5	18,0	9,2
05003670001	7,0	11,8	9,5	18,0	10,4
05003675001	8,0	11,8	9,5	18,0	11,5
05003690001	10,0	11,8	9,5	18,0	13,8
05003684001	12,0	11,8	9,5	18,0	16,8
05003685001	13,0	11,8	9,5	18,0	17,8

Tip

Is such a small tool sufficiently resilient?



The Zyklop Mini 1 can withstand at least 65 Nm. That is far more power than can normally be transferred to such a small tool.

Zyklop Mini 2



The Zyklop Mini 2 is suitable for the direct attachment of the special Wera Zyklop sockets 8790 FA. These sockets feature a very low height, ideal for confined working spaces.



"Take it easy"



"Take it easy" tool finder system – with profile and size colour-coding for quick and easy tool selection. Colour-coded system for hexagon drive screws (L-Keys, Zyklop bit sockets), external hex drive screws and nuts (Joker wrenches, Zyklop sockets and Zyklop bit sockets with holding function), and TORX® drive screws (L-Keys, Zyklop bit sockets).

X-ON Electronics

Largest Supplier of Electrical and Electronic Components

Click to view similar products for [wera](#) manufacturer:

Other Similar products are found below :

[05006120001](#) [05006154001](#) [05073670001](#) [05051021001](#) [05056702001](#) [05060053001](#) [05059291001](#) [05074750001](#) [3160 I/7](#) [8000 A](#) [7460](#)
[7451 ESD 30,0 NCM](#) [7461](#) [816 RA](#) [KRAFTFORM KOMPAKT ZYKLOP 1/4"](#) [190I 3K SW 5,5 X 125 MM](#) [932/6](#) [367 TORX 7](#) [028122](#)
[05004350001](#) [05004352001](#) [167I 3K TX 45 X 150 MM](#) [05004650001](#) [05004660001](#) [05004670001](#) [05118062001](#) [05013334001](#)
[05074705001](#) [8100 SA4](#) [05004970001](#) [05024466001](#) [05024467001](#) [05003881001](#) [05003970001](#) [05003972001](#) [05003973001](#) [05075610001](#)
[05018282001](#) [05133285001](#) [05006451001](#) [05006461001](#) [05004203001](#) [05004202001](#) [05004201001](#) [05020091001](#) [05051016001](#) [8767](#) [8790](#)
[4.5](#) [8790 8.0](#) [8790 14.0](#)