



## Digital ABS Caliper CoolantProof IP67

0-300mm

Item number: 500-708-11



### Description

These robust calipers allow reliable measurements in a wide range of situations.

The ABSOLUTE Digimatic Caliper IP67 offers you the following benefits:

- Excellent resistance against water and dust (IP67 protection level) enabling use in machining situations that include splashing coolant fluid.
- Dustproof, complies with EN60529 withstands temporary complete immersion in water without suffering any damage
- Extraordinarily long battery life.

### Features

Range: **0 - 300 mm**

Depth bar: **flat**

Mass: **345 g**

Accuracy: **≤ 200 mm : ±0,02 mm > 200 mm : ±0,03 mm (excluding quantizing error)**

Digital step: **0,01 mm**

Max. response speed: **Unlimited**

Battery life: **approx. 5 years (150 mm ,200 mm)5000 hours (300 mm)**

Display: **LCD, Character Height 9 mm (150, 200 mm) 10,2 mm (300 mm)**

Delivered: **In a case, including 1 battery**

ORIGIN (ABS-Zero): **Yes**

Auto Power OFF after 20 min. non use: **Yes**

Low voltage alarm: **Yes**

Digital/Analog: **Digital**

Inch-Metric: **Metric**

Functions: **Without thumb roller**



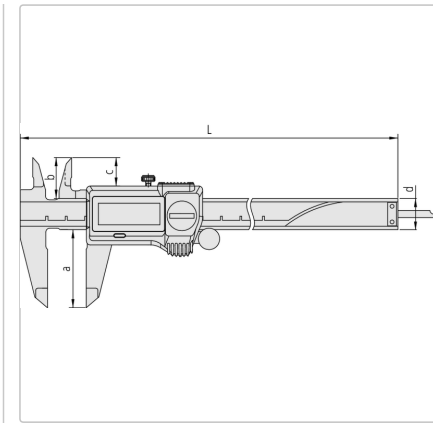



### Dimensions



L: 404 mm  
 a: 64 mm  
 b: 27.5 mm  
 c: 21.8 mm  
 d: 20 mm

## Accessories

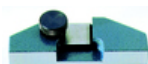
### Optional accessories:

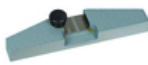
Product	Price
 <b>Digimatic Cable with Data Button IP Type</b> 1m, Caliper Type <b>05CZA624</b>	Price on application
 <b>Digimatic Cable with Data Button IP Type</b> 2m, Caliper Type <b>05CZA625</b>	Price on application
 <b>U-WAVE T Connection Cable A</b> with Data Button IP Caliper Type <b>02AZD790A</b>	Suggested retail price: 97.00 €*
 <b>USB Input Tool Direct (Digimatic USB)</b> with Data Button IP Caliper Type <b>06AFM380A</b>	Suggested retail price: 119.00 €*
 <b>Depth Base Attachment for Caliper, 75mm width</b> for 100, 150, 200mm range <b>050083-10</b>	Suggested retail price: 47.00 €*
 <b>Depth Base Attachment for Caliper, 100 mm width</b> for 100mm, 100, 150, 200mm range <b>050084-10</b>	Suggested retail price: 52.00 €*
 <b>Depth Base Attachment for Caliper, 125 mm width</b> for 300mm range <b>050085-10</b>	Suggested retail price: 59.00 €*

### Consumable spares:

Product	Price

Product	Price	
 SR44 1.5V NO. 938882 Mitsubishi SR44 1.5V NO. 938882	<b>Battery SR44 1.5V</b> <b>938882</b>	Price on application

## **X-ON Electronics**

Largest Supplier of Electrical and Electronic Components

*Click to view similar products for [mitutoyo](#) manufacturer:*

Other Similar products are found below :

[2109S-10](#) [530-104](#) [103-129](#) [148-201](#) [500-171-30](#) [148-104](#) [530-118](#) [293-832](#) [959150](#) [2046SB](#) [543-391B](#) [500-184-30](#) [102-301](#) [575-123](#)  
[500-196-30](#) [2046S](#) [7301](#)