











∅22mm HW Series Control Units











IDEC CORPORATION





ø22 HW Series Control Units (Selection Guide)

Function	Emergency Stop Switch (Unibody Type)		Emergency Stop Switch (Separate Type)		
	Pushlock Turn Reset				
Category	ø40mm Mushroom	ø40mm Mushroom (Illuminated)	ø29mm Mushroom	ø40mm Mushroom	ø60mm Mushroom
Shape					
Type	HW1E-BV4	HW1E-LV4	HW1B-V3	HW1B-V4	HW1B-V5
Page	9	9	11	11	11











Function	Emergency Stop Switch			Pushbutton	
Category	Pushlock Key Reset ø40mm Mushroom	Push Pull ø40mm Mushroom	Pushlock Turn Reset ø40mm EMO	Flush	Extended
	Momentary/Maintained				
Shape					
Type	HW1B-X4	HW1B-Y2	HW1B-V**R-EMO	HW1B-M1 HW1B-A1	HW1B-M2 HW1B-A2
Page	12	12	14	16	16

Function	Pushbutton				
Category	ø29mm Mushroom	ø40 Mushroom	ø60 Mushroom	Square Flush	Square Extended
	Momentary/Maintained		Momentary	Momentary/Maintained	
Shape					
Type	HW1B-M3 HW1B-A3	HW1B-M4 HW1B-A4	HW1B-M5	HW2B-M1 HW2B-A1	HW2B-M2 HW2B-A2
Page	16	16	16	17	17











Function	Pushbutton		
Category	Round Flush w/Square Bezel	Round Extended w/Square Bezel	ø29mm Mushroom w/Square Bezel
	Momentary/Maintained		
Shape			
Type	HW3B-M1 HW3B-A1	HW3B-M2 HW3B-A2	HW3B-M3 HW3B-A3
Page	18	18	18







Function	Pilot Light (LED/Incandescent)			
Category	Flush (Marking)	Extended (Dome)	Square Flush (Marking)	Jumbo Dome
Shape				
Type	HW1P-1	HW1P-2	HW2P-1	HW1P-5
Page	19	19	19	19







HW Series Control Units (Selection Guide) ø22

Function	Illuminated Pushbutton (LED/Incandescent)				
Category	Flush	Extended	Extended w/Full Shroud	Square Flush	Flush w/Square Bezel
Shape	 	 	 	 	 
Type	HW1L-M1 HW1L-A1	HW1L-M2 HW1L-A2	HW1L-MF2 HW1L-AF2	HW2L-M1 HW2L-A1	HW3L-M1 HW3L-A1
Page	21	22	23	24	25

Function	Illuminated Pushbutton (LED/Incandescent)			Dual Pushbutton	
Category	ø29mm Mushroom	ø29mm Mushroom w/ Square Bezel	ø40mm Mushroom	w/o Pilot Light	
Category				Flush (top) Flush (bottom)	Flush (top) Extended (bottom)
Shape	 	 	 	 	 
Type	HW1L-M3 HW1L-A3	HW3L-M3 HW3L-A3	HW1L-M4 HW1L-A4	HW7D-B11 HW7D-B21	HW7D-B12 HW7D-B22
Page	26	27	28	30	30

Function	Dual Pushbutton		Selector Switch		Illuminated Selector Switch (LED/Incandescent)
Category	w/Pilot Light (LED/Incandescent)		Selector	Key	
Category	Flush (top) Flush (bottom)	Flush (top) Extended (bottom)			
Shape	 	 	 	 	 
Type	HW7D-L11 HW7D-L21	HW7D-L12 HW7D-L22	HW1S	HW1K	HW1F
Page	31	31	35	36	37

Function	Pushbutton Selector	Mono-Lever Switch	
Category		Standard	Interlocking
Shape	 	 	 
Type	HW1R	HW1M	HW1M-L
Page	44	45	45

Function	Control Station		Emergency Stop Control Station	
Category	w/Pushbutton	w/Selector Switch	w/Pushlock Turn Reset Switch	w/Pushlock Key Reset Switch
Shape	 	 	 	 
Type	HW1X-BM	HW1X-S	HW1X-BV	HW1X-BX
Page	57	57	57	57



ø22 HW Series Control Units

Complete with finger-safe contact blocks Ensure safety and save wiring time

- Locking lever removable contact blocks
- Spring-up screw and finger-safe (IP20) contact blocks are available.
- Self-cleaning rolling action contacts have a raked contact surface.
- Degree of protection: IP65 (except dual pushbutton: IP40)
- Dual pushbutton switches available with two pushbuttons and a pilot light integrated into one space-saving control unit.
- A wide range of operating voltages for worldwide application
- UL, CSA rated, and EN compliant. 

Application for dual pushbuttons:

Ideal for use as power switches and start/stop switches (available with I/ON and O/OFF markings on the buttons and a pilot light in the center). Interlock type prevents two pushbuttons from being pressed at the same time, providing the best solution for up/down switches.

Applicable Standard	Marking	File No. or Organization
UL508		UL/c-UL File No. E68961
CSA C22.2 No.14		CSA166730 (LR92374) (jumbo dome pilot light: LR21451)
EN60947-5-1		TÜV Rheinland R50054316 (jumbo dome pilot light: R50051481)

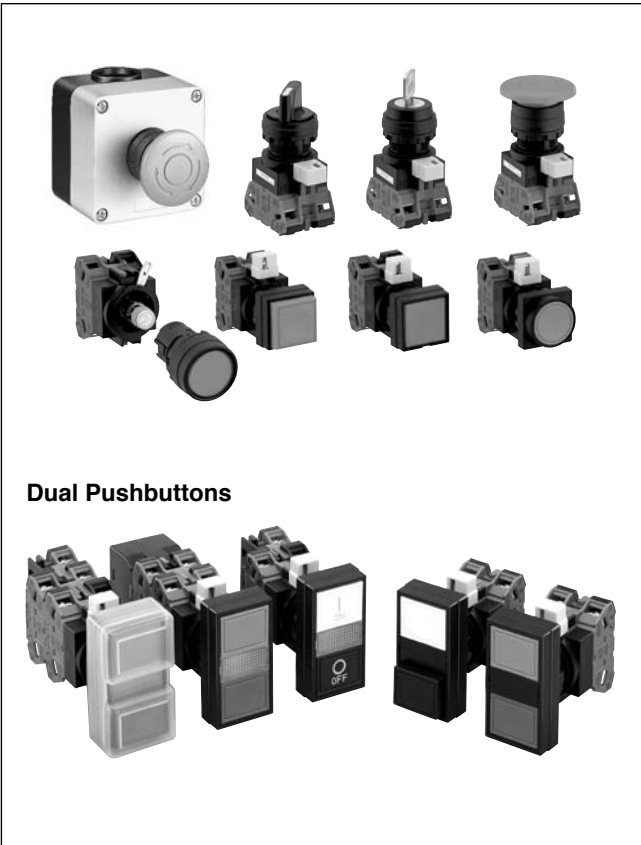

Specifications and Ratings

Contact Ratings

	Contact Block	Type HW-G / HW-F
Pushbuttons	Rated Insulation Voltage	600V
Illuminated Pushbuttons	Rated Thermal Current	10A
Dual Pushbuttons	Contact Ratings by Utilization Category	AC-15 (A600) DC-13 (P600)
Selector Switches	IEC 60947-5-1	
Illuminated Selector Switches		
Pushbutton Selectors		

Characteristics

•Contact Ratings by Utilization Category

		Operational Voltage		24V	48V	50V	110V	220V	440V
Operational Current	AC 50/60 Hz	AC-12	Control of resistive loads and solid state loads	10A	—	10A	10A	6A	2A
		AC-15	Control of electromagnetic loads (> 72 VA)	10A	—	7A	5A	3A	1A
	DC	DC-12	Control of resistive loads and solid state loads	8A	4A	—	2.2A	1.1A	—
		DC-13	Control of electromagnets	4A	2A	—	1.1A	0.6A	—

Note: The operational current represents the classification by making and breaking currents (IEC 60947-5-1).

• Minimum applicable load: 3V AC/DC, 5 mA (applicable range may vary with operating conditions and load types)

For the control units listed below, the rated current (load switching current) is reduced to a half of the rated operational current of the contact block. The rated insulation voltage (600V) and the rated thermal current (10A) remain unchanged.

- 3-position selector switches which contain J or S following 3 in the Type No. and which have cam code J or S. Example: HW1S-3JT21N1
- All 4-position and 5-position selector switches
- All mono-lever switches
- All pushbutton selectors (circuit symbols E, F, N)

Contact Blocks

•HW-G (Spring-up Screw Terminal)

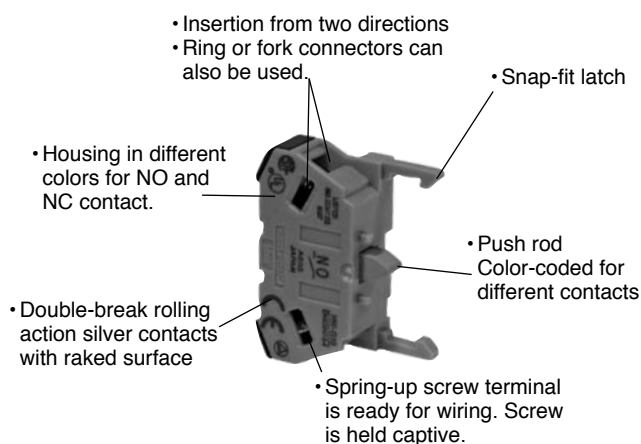

•HW-F (IP20 Finger-Safe Screw Terminal)

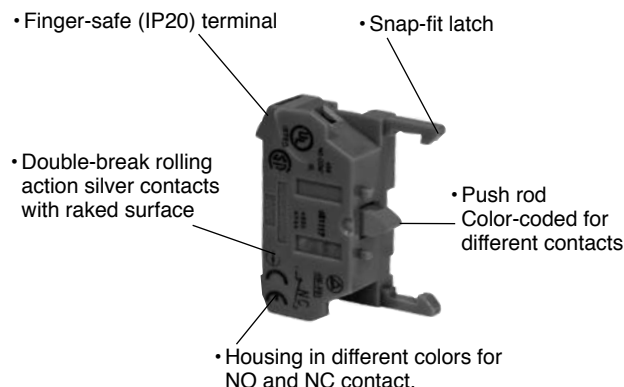

Note: HW-G and HW-F contact blocks have different dimensions. For dimensions, see page 49.

•Contact Block Types

Type No.	HW-G10 HW-F10	HW-G01 HW-F01	HW-G10R HW-F10R	HW-G01R HW-F01R
Contact	NO	NC	NO (early make)	NC (late break)
Housing	Blue	Purple red	Blue	Purple red
Push Rod	Green	Red	Black	White

• Up to 2 layers (4 blocks) can be attached.

LED Illuminated Unit Specifications

Unit	Color Code ②	Input Type	Operating Voltage	LED Lamp			
				Lamp Base	Type No.	Voltage	
Pilot Light Illuminated Pushbutton Illuminated Selector Switch	A: amber G: green PW: pure white R: red S: blue W: white Y: yellow	Full Voltage	6V AC/DC	BA9S/13	LSTD-6②	6V AC/DC±10%	
			12V AC/DC		LSTD-1②	12V AC/DC±10%	
			24V AC/DC		LSTD-2②	24V AC/DC±10%	
		Transformer	100/110V AC 115/120V AC 200/220V AC 230/240V AC 380V AC 400/440V AC 480V AC (50/60 Hz)		LSTD-6②	6V AC/DC±10%	
			DC-DC Converter		110V DC	LSTD-6②	6V AC/DC±10%

• Use a pure white LED for yellow illumination.
• Yellow cannot be used with dual pushbuttons.

Incandescent Illuminated Unit Specifications

Unit	Color Code ②	Input Type	Operating Voltage	LED Lamp		
				Lamp Base	Type No.	Voltage
Pilot Light Illuminated Pushbutton Illuminated Selector Switch	A: amber G: green R: red S: blue W: white	Full Voltage	6V AC/DC	BA9S/13	LS-6	1W (6.3V)
			12V AC/DC		LS-8	1W (18V)
			24V AC/DC		LS-3	1W (30V)
		Transformer	100/110V AC 115/120V AC 200/220V AC 230/240V AC 380V AC 400/440V AC 480V AC (50/60 Hz)		LS-6	1W (6.3V)

• For LED and incandescent unit specifications of jumbo dome pilot lights, see page 6.

**LED Lamp Ratings (LSTD Type)
(Except Jumbo Dome Pilot Lights)**

Type No.	LSTD-6②	LSTD-1②	LSTD-2②
Lamp Base	BA9S/13		
Rated Voltage	6V AC/DC	12V AC/DC	24V AC/DC
Voltage Range	6V AC/DC ±10%	12V AC/DC ±10%	24V AC/DC ±10%
Current Draw	AC	8 mA	11 mA
	DC	A, R, W: 7 mA G, PW, S: 5.5 mA	10 mA
Color Code	A (amber), G (green), PW (pure white), R (red), S (blue), W (white)		
Lamp Base Color	Same as illumination color		
Voltage Marking	Die stamped on the base		
Life (reference value)	Approx. 50,000 hours (until the brightness reduces to 50% the initial value when lit at complete direct current of the rated voltage under 25°C environment.)		
Internal Circuit			

**LED Lamp Ratings (LSTDB Type)
(For Jumbo Dome Pilot Lights Only)**

Type No.	LSTDB-2②	
Rated Voltage	24V AC/DC	
Voltage Range	24V AC/DC ±10%	
Current Draw	15 mA	
Color Code	A (amber), G (green), PW (pure white), R (red), S (blue), W (white)	
Life (reference value)	Approx. 20,000 hours (until the brightness reduces to 50% the initial value when lit at complete direct current of the rated voltage under 25°C environment.)	
Internal Circuit	A, R, W	
	G, PW, S	

• Use a pure white LED for yellow illumination.

**Incandescent Lamp Ratings (LS Type)
(Except Jumbo Dome Pilot Lights)**

Type No.	LS-6	LS-8	LS-2	LS-3
Lamp Base	BA9S/13			
Rated Voltage	6V AC/DC	12V AC/DC	18V AC/DC	24V AC/DC
Wattage	1W (6.3V)	1W (18V)	1W (24V)	1W (30V)
Voltage Marking	Die stamped on the base			
Life (reference value)	Approx. 1,000 hours minimum (mean value when used on the rated voltage)			

**Incandescent Lamp Ratings (LSB Type)
(For Jumbo Dome Pilot Lights Only)**

Type No.	LSB-2
Rated Voltage	24V AC/DC
Wattage	3.6W
Lamp Rating	28V, 0.17A
Life (reference value)	Approx. 1,000 hours (Mean value at the rated voltage.)

• Use incandescent lamp types for displaying the muting status (temporary automatic suspension of a safety function, required by IEC61496-1) of equipment such as light curtains.

Specifications

Operating Temperature	-25 to +60°C (no freezing) Illuminated units: -25 to +50°C Jumbo dome pilot lights: -25 to +55°C	
Storage Temperature	-40 to +80°C	
Operating Humidity	45 to 85% RH (no condensation)	
Contact Resistance	50 mΩ maximum (initial value)	
Insulation Resistance	100 MΩ minimum (500V DC megger)	
Dielectric Strength (Note)	Between live and dead metal parts: 2,500V AC, 1 minute (Full voltage type illuminated units: 2,000V AC, 1 minute)	
Vibration Resistance	Operating extremes: 5 to 55 Hz, amplitude 0.5 mm	
Shock Resistance	Damage limits: 1,000 m/s ² Operating extremes: 100 m/s ²	
Mechanical Life (minimum operations)	Pushbuttons, Illuminated pushbuttons	Key selector switches: 500,000
	Momentary: 5,000,000 Maintained: 500,000 Dual pushbuttons: 500,000 Selector switches: 500,000	Illuminated selector switches: 500,000 Pushbutton selectors: 250,000 Mono-lever switches: 250,000
Electrical Life (minimum operations)	Pushbuttons, Illuminated pushbuttons: 500,000 *1 Dual pushbuttons: 500,000 *1 Selector switches: 500,000 *2 Key selector switches: 500,000 *2	Illuminated selector switches: 500,000 *2 Pushbutton selectors: 250,000 *2 Mono-lever switches: 250,000 *3
	*1 Switching frequency 1,800 operations/h, duty ratio 40% *2 Switching frequency 1,200 operations/h, duty ratio 40% *3 Switching frequency 900 operations/h, duty ratio 40%	
Weight	66g (HW1B-M122), 20g (HW1P-1Q4), 84g (HW1L-M122Q4), 66g (HW1S-2T22), 94g (HW1K-2A22), 84g (HW1F-222Q4), 71g (HW1R-2A22), 82g (HW1M-2222-22N9), 72g (HW7D-B111111), 90g (HW7D-L111111Q4)	

Note: Dielectric strength for dual pushbuttons are as follows:

- Without pilot light: 2,500V AC, 1 minute (between live and dead metal parts)
- With pilot light:
 - Full voltage type: 1,000V AC, 1 minute (between live and dead metal parts)
 - Transformer and DC-DC converter types: 2,000V AC, 1 minute (between live and dead metal parts)

Degree of Protection

Unit	NEMA ICS 6-110	IEC 60529
All units except dual pushbutton switches	Type 1, 2, 3, 3R, (3S), 4, 5, 12,13	IP65 (Note 1)
Dual pushbutton switches		IP40 (Note 2)

Note 1: When using a nameplate with the control unit, IP65 protection degree is achieved only when nameplates shown on page 46 are used.
 Note 2: IP65 protection degree when HW9Z-D7D button cover is used.

Mounting Hole Layout

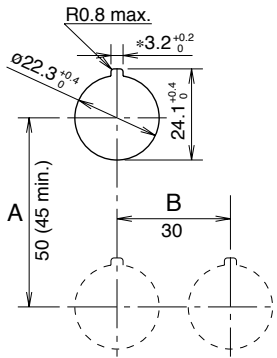

* The 3.2 mm recess is for preventing rotation and is not necessary when the nameplate or anti-rotation ring is not used.

The minimum mounting centers are applicable to switches with one layer of contact blocks (two contact blocks). When two layers of contact blocks are mounted, determine the minimum mounting centers in consideration of convenience for wiring.

• Minimum Mounting Centers

Unit	A	B
ø40mm mushroom button	50 mm	40 mm
Pilot light	30 mm	30 mm
Pushbutton selector	50 mm	50 mm
Mono-lever switch	72 mm	72 mm
Jumbo dome pilot	85 mm	85 mm
Dual pushbutton switches	55 mm	30 mm

Note: When using the safety lever lock, determine the vertical spacing (A) in consideration of convenience for installing and removing the safety lever lock.
 Recommended vertical spacing: 100 mm

Ordering Information

The Type No. development charts shown below can be used to specify control units other than those listed on the following pages. Gold-plated silver contacts are also available.

Emergency Stop Switches (Separate Type)

For emergency stop purposes, these switches must contain at least one NC contact block.

HW1B-V4 F 11 R -MAU

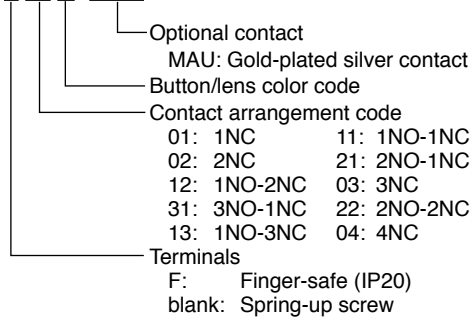

Note: Push-pull type HW1B-Y2 can have a maximum of two contact blocks.

Pushbuttons

HW1B-M1 F 11 R -MAU

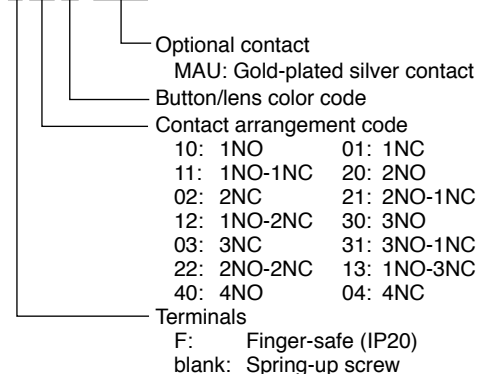

Illuminated Pushbuttons

HW1L-M1 F 11 H 2 R -MAU

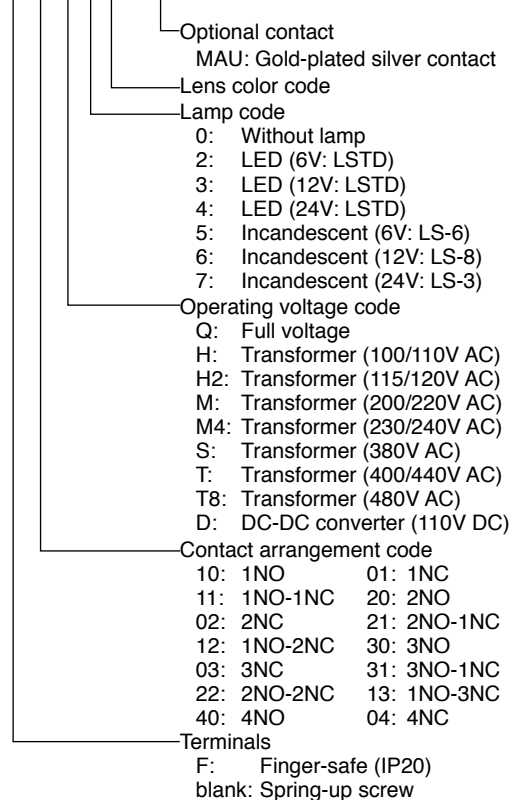

Note:
 Full voltage type is not supplied with a lamp.
 Transformer and DC-DC converter types contain an LED lamp (LSTD-6②) or incandescent lamp (LS-6).
 Transformer and DC-DC converter types can have two or four contact blocks only.

Dual Pushbutton Switches w/o Pilot Light

HW7D-B 1 1 F 10 02 GR 1 -MAU

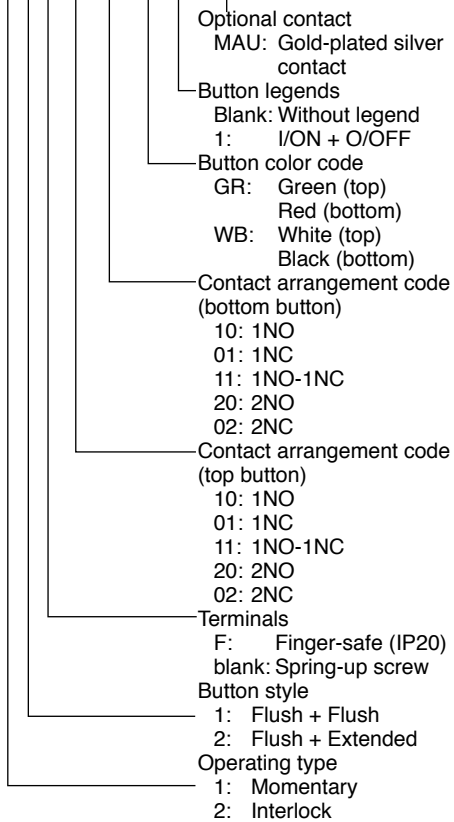

Dual Pushbutton Switches with Pilot Light

HW7D-L 1 1 F 11 20 H 2 R -GR 1 -MAU

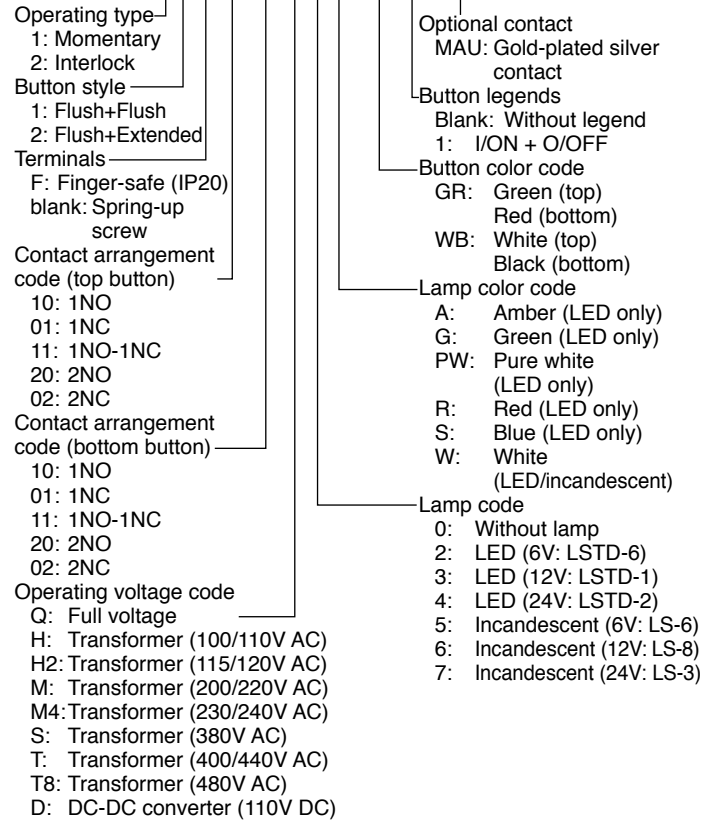

Note:

Full voltage type is not supplied with a lamp.

Transformer and DC-DC converter types contain an LED lamp (LSTD-6[Ⓜ]) or incandescent lamp (LS-6).

Transformer and DC-DC converter types can have two or four contact blocks only.

Selector Switches

HW1S-3 S T F 22N9 -MAU

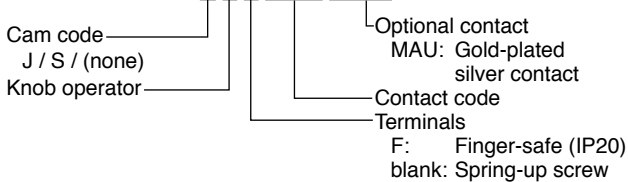

Illuminated Selector Switches

HW1F-2 F 11 H 2 R -MAU

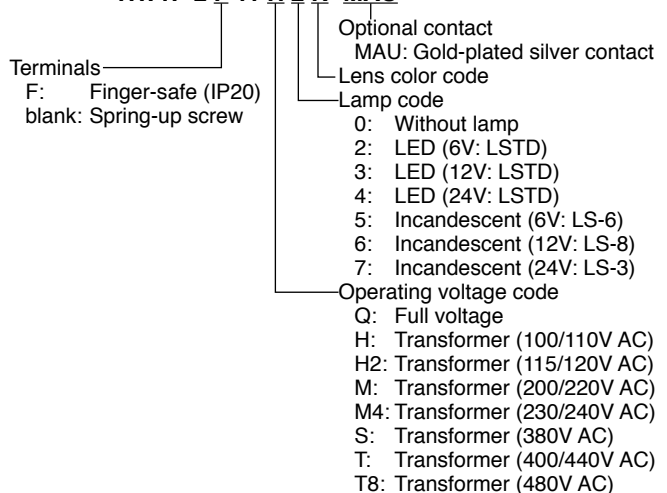

Key Selector Switches

HW1K-2 A F 11 - 1H -MAU

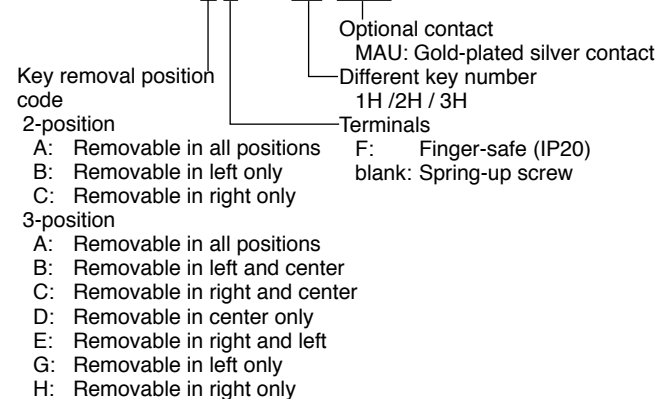

Note:

Full voltage type is not supplied with a lamp.

Transformer type contains an LED lamp (LSTD-6[Ⓜ]) or incandescent lamp (LS-6).

Note: Key is not removable from spring-return positions.

Pushbutton Selectors

HW1R-2 D F 22N1 B -MAU

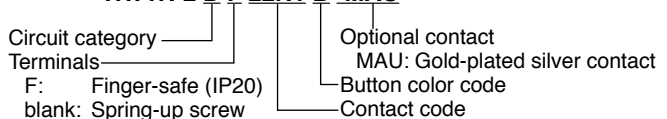

Emergency Stop Switches (Unibody Type) Specifications

Contact Ratings

Rated Insulation Voltage (Ui)		250V			
Rated Thermal Current (Ith)		10A			
Rated Operational Voltage (Ue)		24V	110V	220V	
Rated Operational Current	AC 50/60 Hz	Resistive Load (AC-12)	6A	3A	3A
		Inductive Load (AC-15)	6A	3A	3A
	DC	Resistive Load (DC-12)	6A	2A	1A
		Inductive Load (DC-13)	1.5A	0.3A	0.15A

- Minimum applicable load (reference value): 3V AC/DC, 5 mA (Applicable range may vary with operating conditions and load types.)
- The operational current represents the classification by making and breaking currents (IEC 60947-5-1).

LED Lamp Ratings

Unit Rated Operating Voltage	LED Lamp		
	Type No.	Rated Voltage	Rated Current
6V AC/DC	LSTD-6R	6V AC/DC ±10%	7 mA
12V AC/DC	LSTD-1R	12V AC/DC ±10%	10 mA
24V AC/DC	LSTD-2R	24V AC/DC ±10%	10 mA





Incandescent Lamp Ratings

Unit Rated Operating Voltage	LED Lamp	
	Type No.	Wattage
6V AC/DC	LS-6	1W (6.3V)
12V AC/DC	LS-8	1W (18V)
24V AC/DC	LS-3	1W (30V)







Specifications

Operating Temperature	-25 to +60°C (no freezing) Illuminated units: -25 to +55°C
Storage Temperature	-40 to +80°C
Operating Humidity	45 to 85% RH (no condensation)
Contact Resistance	50 mΩ maximum (initial value)
Insulation Resistance	100 MΩ minimum (500V DC megger)
Dielectric Strength	Between live and dead metal parts: Contacts: 2,500V AC, 1 minute
	Illuminated parts: 1,000V AC, 1 minute
Vibration Resistance	Damage limits: 60 m/s ²
	Operating extremes: 5 to 55 Hz, amplitude 0.5 mm
Shock Resistance	Damage limits: 1,000 m/s ²
	Operating extremes: 100 m/s ²
Operating Frequency	900 operations/h
Life	Mechanical: 250,000 operations minimum
	Electrical: 100,000 operations minimum (at 900 operations/h, duty ratio 40%)
Degree of Protection	IP65
Terminal Style	M3.5 screw
Weight	49g (HW1E-BV402R)
	56g (HW1E-LV402Q4R)

Applicable Standards and Approvals







Safety Standards	Marking	File No. or Organization
UL508 CSA C22.2 No. 14		UL Listing File No. E55996
EN60947-5-5		DEMKO approved
		Self declaration (EC Low Voltage Directive)
GB14048.5		CCC No.2004010305132908

Pushlock Turn Reset Switches (Unibody Type)

Shape	Contact	Type No.	Button Color
ø40mm Mushroom Pushlock Turn Reset HW1E-BV4      	1NO-1NC	HW1E-BV4F11R	Red only
	2NC	HW1E-BV4F02R	

- When pressed, the button is held depressed. The button is released by turning clockwise.
- Finger-safe (IP20) terminal.

Illuminated Pushlock Turn Reset Switches (Unibody Type)

Shape	Contact	Type No.	Button Color
ø40mm Mushroom Pushlock Turn Reset HW1E-LV4      	1NO-1NC	HW1E-LV4F11Q0R	Red only
	2NC	HW1E-LV4F02Q0R	

- When pressed, the button is held depressed. The button is released by turning clockwise.
- The illuminated pushlock turn reset switch does not contain a lamp. Order LED or incandescent lamps separately. For lamps, see page 51.
- Finger-safe (IP20) terminal.

∅22 HW Series Emergency Stop Switches

Dimensions

•HW1E-BV4

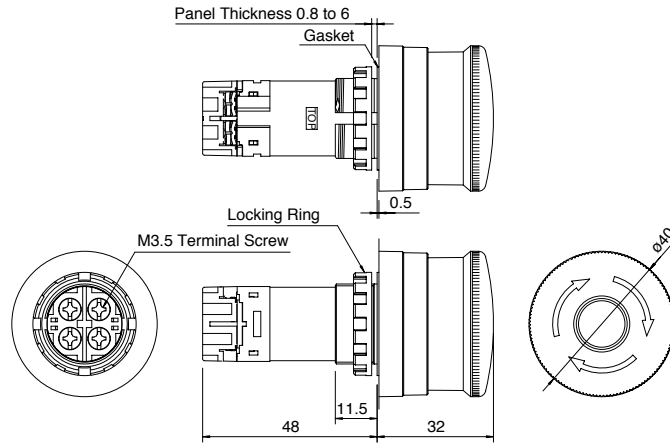

•HW1E-LV4

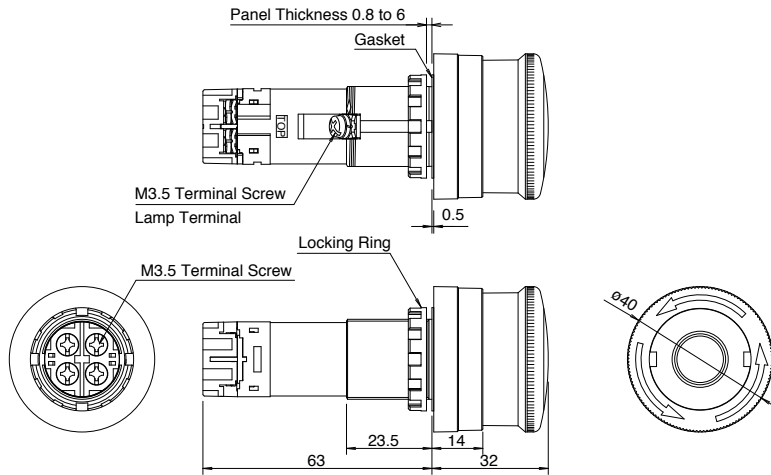

All dimensions in mm.

Mounting Hole

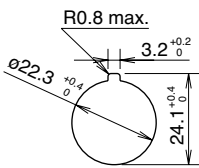

Determine the minimum mounting hole centers in consideration of convenience for wiring.

Terminal Arrangement (Bottom View)

•HW1E-BV4

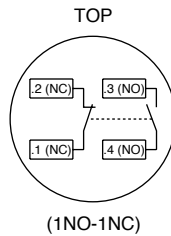

•HW1E-LV4

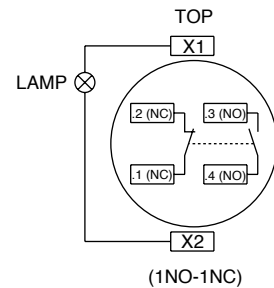

Emergency Stop Switches (Separate Type) Specifications

Contact Ratings

Contact Block	Rated Insulation Voltage	600V
	Rated Thermal Current	10A
	Contact Ratings by Utilization Category IEC 60947-5-1	AC-15 (A600) DC-13 (P600)

Characteristics

• Contact Ratings by Utilization Category

Operational Voltage		24V	48V	50V	110V	220V	440V	
Operational Current	AC 50/60 Hz	AC-12 Control of resistive loads and solid state loads	10A	—	10A	10A	6A	2A
		AC-15 Control of electromagnetic loads (> 72 VA)	10A	—	7A	5A	3A	1A
Operational Current	DC	DC-12 Control of resistive loads and solid state loads	8A	4A	—	2.2A	1.1A	—
		DC-13 Control of electromagnets	4A	2A	—	1.1A	0.6A	—

Applicable Standards and Approvals

Safety Standards	Marking	File No. or Organization
UL508		UL Listing File No. E68961
CSA C22.2 No. 14		File No. LR92374
EN60947-5-5		DEMKO approved
		Self declaration (EC Low Voltage Directive)
GB14048.5		CCC No.2005103050145656

Specifications

Operating Temperature	–25 to +60°C (no freezing)
Storage Temperature	–40 to +80°C
Operating Humidity	45 to 85% RH (no condensation)
Contact Resistance	50 mΩ maximum (initial value)
Insulation Resistance	100 MΩ minimum (500V DC megger)
Dielectric Strength	Between live and dead metal parts
	Between terminals of different poles Between terminals of the same pole 2,500V AC, 1 minute
Vibration Resistance	Damage limits: 60 m/s ²
	Operating extremes: 5 to 55 Hz, amplitude 0.5 mm
Shock Resistance	Damage limits: 1,000 m/s ²
	Operating extremes: 100 m/s ²
Operating Frequency	900 operations/h
Life	Mechanical: 500,000 operations minimum (push-pull: 250,000 operations)
	Electrical: 500,000 operations minimum (push-pull: 250,000 operations) (at 900 operations/h, duty ratio 40%)
Degree of Protection	IP65
Terminal Style	M3.5 screw
Weight	76g (HW1B-V322)
	99g (HW1B-X422R)
	54g (HW1B-Y202)
	79g (HW1B-V422R-EMO)

Pushlock Turn Reset Switches (Separate Type)

Shape	Contact	Type No.	Button Color
ø29mm Mushroom Pushlock Turn Reset HW1B-V3 	1NC	HW1B-V3Ⓞ01Ⓜ	Specify a button color code in place of Ⓜ in the Type No. R: red Y: yellow
	1NO-1NC	HW1B-V3Ⓞ11Ⓜ	
	2NC	HW1B-V3Ⓞ02Ⓜ	
	2NO-2NC	HW1B-V3Ⓞ22Ⓜ	
ø40mm Mushroom Pushlock Turn Reset HW1B-V4 	1NC	HW1B-V4Ⓞ01Ⓜ	
	1NO-1NC	HW1B-V4Ⓞ11Ⓜ	
	2NC	HW1B-V4Ⓞ02Ⓜ	
	2NO-2NC	HW1B-V4Ⓞ22Ⓜ	
ø60mm Mushroom Pushlock Turn Reset HW1B-V5 	1NC	HW1B-V5Ⓞ01Ⓜ	
	1NO-1NC	HW1B-V5Ⓞ11Ⓜ	
	2NC	HW1B-V5Ⓞ02Ⓜ	
	2NO-2NC	HW1B-V5Ⓞ22Ⓜ	

- Specify a terminal style code in place of Ⓞ in the Type No. F: Finger-safe (IP20), blank: Spring-up screw
- Yellow buttons cannot be used as emergency stop switches in compliance with EN standards.
- When pressed, the button is held depressed. The button is released by turning clockwise.
- Pushlock turn reset switches with one or three contact blocks contain a dummy block.
- Safety lever lock HW9Z-LS is supplied with the switch.
- Other contact arrangements and gold-plated silver contacts are also available. See page 7.

ø22 HW Series Emergency Stop Switches

Pushlock Key Reset Switches (Separate Type)

Shape	Contact	Type No.	Button Color
ø40mm Mushroom Pushlock Key Reset HW1B-X4 	1NC	HW1B-X4®01R	Red only
	1NO-1NC	HW1B-X4®11R	
	2NC	HW1B-X4®02R	
	2NO-2NC	HW1B-X4®22R	

- Specify a terminal style code in place of ® in the Type No. F: Finger-safe (IP20), blank: Spring-up screw
- When pressed, the button is held depressed. The button is released by turning the key clockwise.
- Pushlock key reset switches with one or three contact blocks contain a dummy block.
- Two identical keys and safety lever lock HW9Z-LS are supplied with the switch.
- Other contact arrangements and gold-plated silver contacts are also available. See page 7.

Push-Pull Switches (Separate Type)

Shape	Contact	Type No.	Button Color
ø40mm Mushroom Push-Pull (2-position) HW1B-Y2 	1NC	HW1B-Y2®01①	Specify a button color code in place of ① in the Type No. R: red Y: yellow
	1NO-1NC	HW1B-Y2®11①	
	2NC	HW1B-Y2®02①	

- Specify a terminal style code in place of ® in the Type No. F: Finger-safe (IP20), blank: Spring-up screw
- The button is maintained at either pulled or depressed position.
- Push-pull switches are available with one or two contact blocks.
- Push-pull switches with one contact block contain a dummy block.
- Safety lever lock HW9Z-LS is supplied with the switch.

Accessory

Nameplate

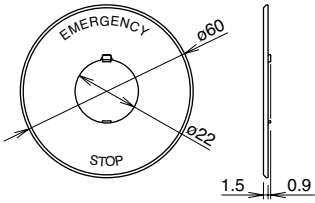
Shape	Name	Type No.	Legend	Package Quantity	Remarks
	Nameplate for Emergency Stop Switch (See page 13 for panel cut- out.)	HWAV-0-Y	(blank)	1	Background: Yellow Legend: Black Applicable panel thickness: 0.8 to 4.5 mm Material: Polyamide Not applicable for ø60 mm mushroom buttons. Legend "EMERGENCY STOP" is indi- cated outside a ø44mm circle.
		HWAV-27-Y	EMERGENCY STOP		

Dimensions

•Ø29mm Pushlock Turn Reset HW1B-V3

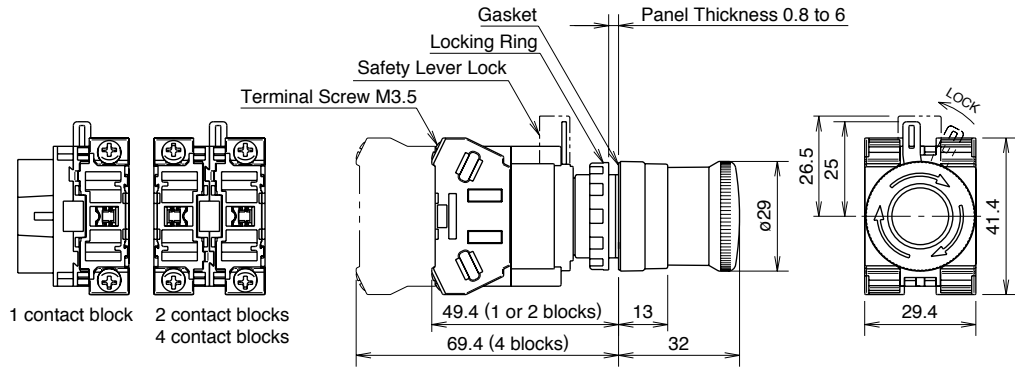

The above figure illustrates the spring-up screw type.

The depth of each finger-safe (IP20) contact block is 0.9 mm longer than that of a spring-up screw contact block.

All dimensions in mm.

•Ø40mm Pushlock Turn Reset HW1B-V4

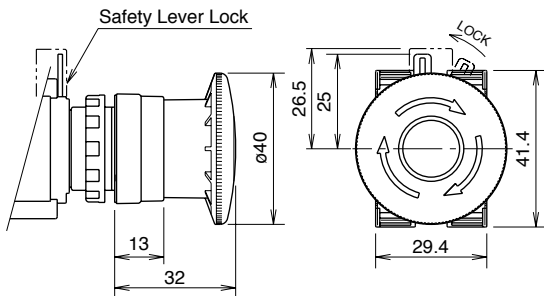

•Ø60mm Pushlock Turn Reset HW1B-V5

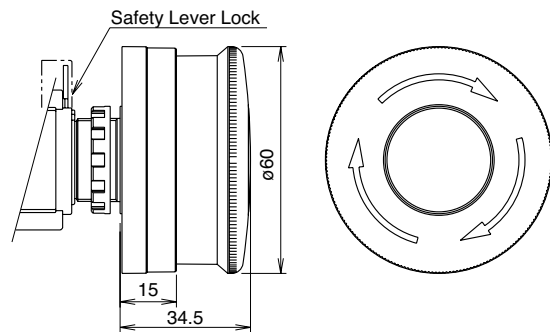

•Ø40mm Pushlock Key Reset HW1B-X4

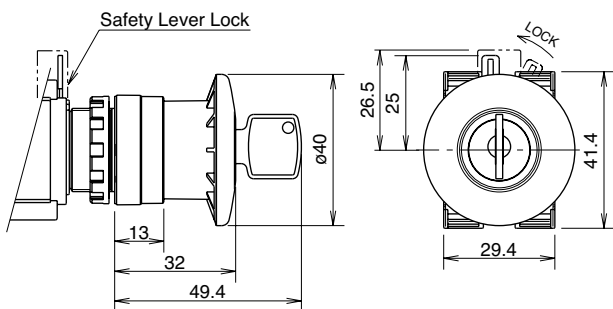

•Ø40mm Push-Pull HW1B-Y2

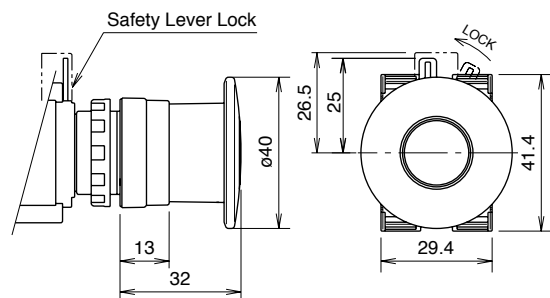

All dimensions in mm.

Panel Cut-Out

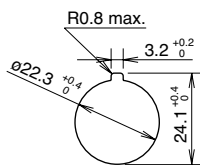

The minimum mounting centers shown below are applicable to emergency stop switches with one layer of contact blocks (two contact blocks). When two layers of contact blocks are mounted, determine the minimum mounting centers in consideration of convenience for wiring.

•Minimum Mounting Centers for Emergency Stop Switches

Unit	Vertical Spacing	Horizontal Spacing
HW1B-V3 HW1B-V4 HW1B-X4 HW1B-Y2	50 mm	50 mm
HW1B-V5	60 mm	60 mm

Note: When using the safety lever lock, determine the vertical spacing in consideration of convenience for installing and removing the safety lever lock.
Recommended vertical spacing: 100 mm

For emergency stop control stations, see page 57.

ø22 HW Series Emergency Stop Switches

EMO Pushbuttons EMO is an abbreviation of Emergency Off. Used for emergency stop according to SEMI standards.

Shape	Contact	Type No.	Button Color
ø40mm Mushroom Pushlock Turn Reset HW1E-BV4 	1NC	HW1B-V4®01R-EMO	Red only (Legend: White)
	1NO-1NC	HW1B-V4®11R-EMO	
	2NC	HW1B-V4®02R-EMO	
	2NO-2NC	HW1B-V4®22R-EMO	

• Specify a terminal style code in place of ® in the Type No. F: Finger-safe (IP20), blank: Spring-up screw

Dimensions

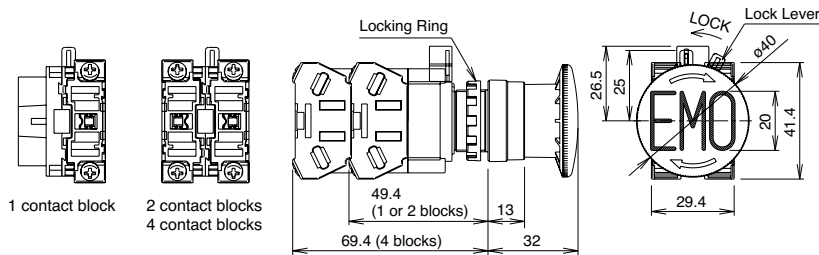







All dimensions in mm.

The above figure illustrates the spring-up screw type.

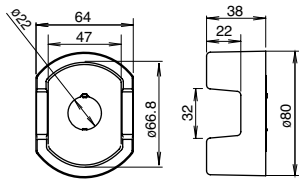
The depth of each finger-safe (IP20) contact block is 0.9 mm longer than that of a spring-up screw contact block.

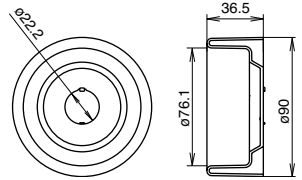
SEMI Standard Compliant Switch Guards (For ø22mm mounting hole)

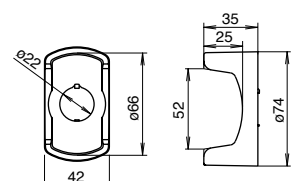
• SEMI S2-0200 12.5.1 Compliant

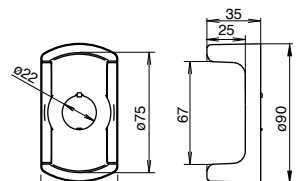
Description & Appearance	Type No.	Applicable Emergency Stop Switches	Dimensions
EMO Switch Guard SEMI S2 compliant (Note 1) 	HW9Z-KG1	HW1B-V3 HW1B-V4 HW1B-X4 HW1B-Y2 HW1E-BV4 HW1E-LV4 XW1E-BV4 XW1E-LV4 XW1E-TV4	
EMO Switch Guard SEMI S2 compliant (Note 1) SEMATECH compliant (Note 2) 	HW9Z-KG2	HW1B-V3 HW1B-V4 HW1B-X4 HW1B-Y2 HW1E-BV4 HW1E-LV4 XW1E-BV4 XW1E-LV4 XW1E-TV4	
EMO Switch Guard SEMI S2 compliant (Note 3) 	HW9Z-KG3	HW1B-V3 HW1B-V4 HW1B-X4 HW1B-Y2 XW1E-BV4 XW1E-LV4 XW1E-TV4	
EMO Switch Guard SEMI S2 compliant (Note 3) SEMATECH compliant (Note 2) 	HW9Z-KG4	HW1B-V3 HW1B-V4 HW1B-X4 HW1B-Y2 HW1E-BV4 HW1E-LV4 XW1E-BV4 XW1E-LV4 XW1E-TV4	

Description & Appearance	Type No.	Applicable Emergency Stop Switches	Dimensions
EMO Switch Guard SEMI S2 compliant (Note 3) SEMATECH compliant (Note 2)	HW9Z-KG5	HW1B-V3 HW1B-V4 HW1B-X4 HW1B-Y2 HW1E-BV4 HW1E-LV4 XW1E-BV4 XW1E-LV4 XW1E-TV4 XW1E-BV5	

Note 1: SEMI S2-0703, 12.5.1 compliant.

Note 2: SEMATECH Application Guide for SEMI S2-93, 12.4. compliant.

Note 3: The combination of IDEC's emergency stop switches and EMO switch guards are approved by TÜV Rheinland for compliance with SEMI S2 standard.

- Degree of protection IP65 applies to the combination of an emergency stop switch and an EMO switch guard.
- HW9Z-KG1, HW9Z-KG2, and HW9Z-KG3 can be used with ø29mm or ø40mm mushroom buttons. ø60mm jumbo mushroom buttons cannot be installed.

Panel Cut-out

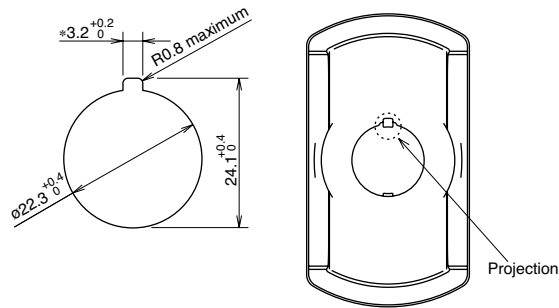

The $*3.2^{+0.2}_0$ recess is for preventing rotation and not necessary when anti-rotation is not used.

When anti-rotation is not required or when the panel cut-out does not have anti-rotation recess, remove the projection using pliers.

Installation

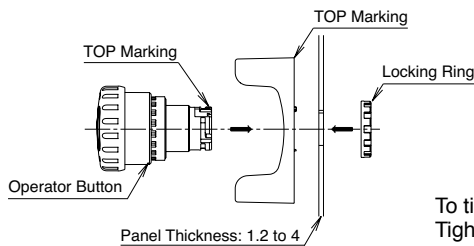

To tighten the locking ring, use locking ring wrench MW9Z-T1. Tighten the locking ring to a torque of 2.0 N·m.

EMO Sticker



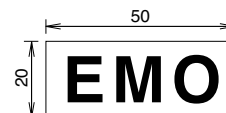
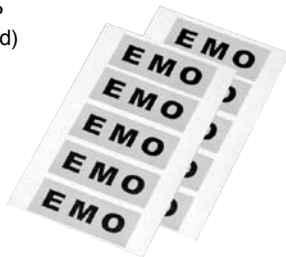







- Type No.: HW9Z-EMO-NPP
- Color: Yellow (red legend)
- Package Quantity: 10

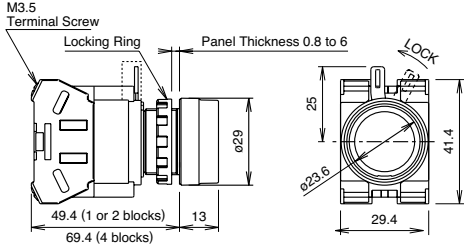

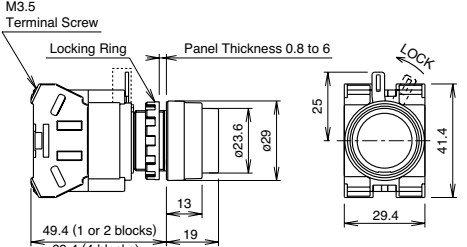
Note:

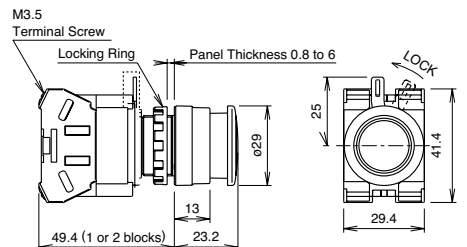

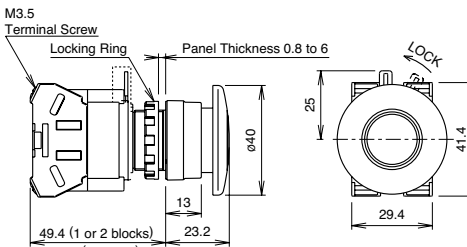

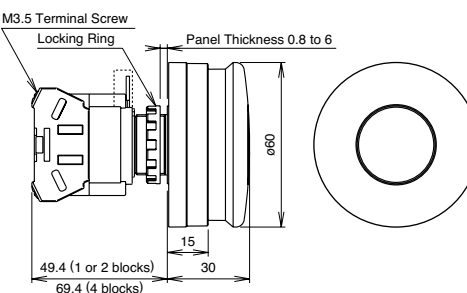
EMO switch guards have been designed for applications in semiconductor manufacturing equipment only. Do not use the EMO switch guards with emergency stop switches which are installed on machine tools or food processing machines. (Machinery Directive of the European Commission and IEC 60204-1 require that emergency stop switches be installed in a readily accessible area, and the usage of switch guards is not permitted.)

Flush / Extended / Mushroom Types

Shape	Operation Type	Contact	Type No.	① Button Color Code	Dimensions (Spring-up screw type)
Flush HW1B-M1 HW1B-A1  	Momentary	1NO	HW1B-M1⑥10①	Specify a button color code in place of ① in the Type No. B: black G: green R: red S: blue W: white Y: yellow	
		1NC	HW1B-M1⑥01①		
		1NO-1NC	HW1B-M1⑥11①		
		2NO	HW1B-M1⑥20①		
		2NC	HW1B-M1⑥02①		
		2NO-2NC	HW1B-M1⑥22①		
	Maintained	1NO	HW1B-A1⑥10①		
		1NC	HW1B-A1⑥01①		
		1NO-1NC	HW1B-A1⑥11①		
		2NO	HW1B-A1⑥20①		
		2NC	HW1B-A1⑥02①		
		2NO-2NC	HW1B-A1⑥22①		
Extended HW1B-M2 HW1B-A2  	Momentary	1NO	HW1B-M2⑥10①	Specify a button color code in place of ① in the Type No. B: black G: green R: red S: blue W: white Y: yellow	
		1NC	HW1B-M2⑥01①		
		1NO-1NC	HW1B-M2⑥11①		
		2NO	HW1B-M2⑥20①		
		2NC	HW1B-M2⑥02①		
		2NO-2NC	HW1B-M2⑥22①		
	Maintained	1NO	HW1B-A2⑥10①		
		1NC	HW1B-A2⑥01①		
		1NO-1NC	HW1B-A2⑥11①		
		2NO	HW1B-A2⑥20①		
		2NC	HW1B-A2⑥02①		
		2NO-2NC	HW1B-A2⑥22①		
ø29mm Mushroom HW1B-M3 HW1B-A3  	Momentary	1NO	HW1B-M3⑥10①	Specify a button color code in place of ① in the Type No. B: black G: green R: red S: blue W: white Y: yellow	
		1NC	HW1B-M3⑥01①		
		1NO-1NC	HW1B-M3⑥11①		
		2NO	HW1B-M3⑥20①		
		2NC	HW1B-M3⑥02①		
		2NO-2NC	HW1B-M3⑥22①		
	Maintained	1NO	HW1B-A3⑥10①		
		1NC	HW1B-A3⑥01①		
		1NO-1NC	HW1B-A3⑥11①		
		2NO	HW1B-A3⑥20①		
		2NC	HW1B-A3⑥02①		
		2NO-2NC	HW1B-A3⑥22①		
ø40mm Mushroom HW1B-M4 HW1B-A4  	Momentary	1NO	HW1B-M4⑥10①	Specify a button color code in place of ① in the Type No. B: black G: green R: red	
		1NC	HW1B-M4⑥01①		
		1NO-1NC	HW1B-M4⑥11①		
		2NO	HW1B-M4⑥20①		
		2NC	HW1B-M4⑥02①		
		2NO-2NC	HW1B-M4⑥22①		
	Maintained	1NO	HW1B-A4⑥10①		
		1NC	HW1B-A4⑥01①		
		1NO-1NC	HW1B-A4⑥11①		
		2NO	HW1B-A4⑥20①		
		2NC	HW1B-A4⑥02①		
		2NO-2NC	HW1B-A4⑥22①		
ø60mm Mushroom HW1B-M5  	Momentary	1NO	HW1B-M5⑥10①	Specify a button color code in place of ① in the Type No. B: black G: green R: red	
		1NC	HW1B-M5⑥01①		
		1NO-1NC	HW1B-M5⑥11①		
		2NO	HW1B-M5⑥20①		
		2NC	HW1B-M5⑥02①		
		2NO-2NC	HW1B-M5⑥22①		

- Specify a terminal style code in place of ⑥ in the Type No. F: Finger-safe (IP20), blank: Spring-up screw
- Pushbuttons with one or three contact blocks contain a dummy block.
- Other contact arrangements and gold-plated silver contacts are also available. See page 7.
- The depth of each finger-safe (IP20) contact block is 0.9 mm longer than that of a spring-up screw contact block.

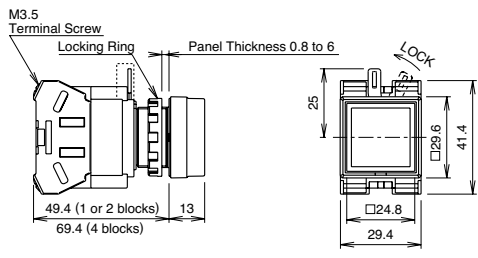
Square Flush / Square Extended Types

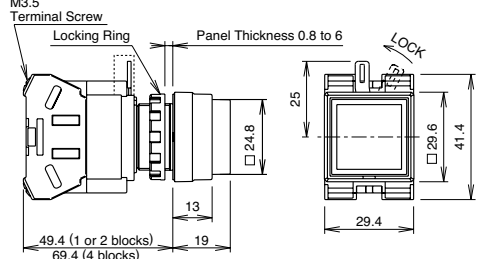
Shape	Operation Type	Contact	Type No.	① Button Color Code	Dimensions (Spring-up screw type)
Square Flush HW2B-M1 HW2B-A1  	Momentary	1NO	HW2B-M1⑥10①	Specify a button color code in place of ① in the Type No. B: black G: green R: red S: blue W: white Y: yellow	
		1NC	HW2B-M1⑥01①		
		1NO-1NC	HW2B-M1⑥11①		
		2NO	HW2B-M1⑥20①		
		2NC	HW2B-M1⑥02①		
	Maintained	2NO-2NC	HW2B-M1⑥22①		
		1NO	HW2B-A1⑥10①		
		1NC	HW2B-A1⑥01①		
		1NO-1NC	HW2B-A1⑥11①		
		2NO	HW2B-A1⑥20①		
Square Extended HW2B-M2 HW2B-A2  	Momentary	1NO	HW2B-M2⑥10①	Specify a button color code in place of ① in the Type No. B: black G: green R: red S: blue W: white Y: yellow	
		1NC	HW2B-M2⑥01①		
		1NO-1NC	HW2B-M2⑥11①		
		2NO	HW2B-M2⑥20①		
		2NC	HW2B-M2⑥02①		
	Maintained	2NO-2NC	HW2B-M2⑥22①		
		1NO	HW2B-A2⑥10①		
		1NC	HW2B-A2⑥01①		
		1NO-1NC	HW2B-A2⑥11①		
		2NO	HW2B-A2⑥20①		
	2NC	HW2B-A2⑥02①			
	2NO-2NC	HW2B-A2⑥22①			

- Specify a terminal style code in place of ⑥ in the Type No. F: Finger-safe (IP20), blank: Spring-up screw
- Pushbuttons with one or three contact blocks contain a dummy block.
- Other contact arrangements and gold-plated silver contacts are also available. See page 7.
- The depth of each finger-safe (IP20) contact block is 0.9 mm longer than that of a spring-up screw contact block.

Contact Block (Bottom View)

Spring-up screw type

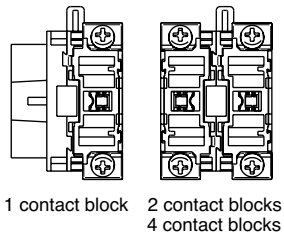



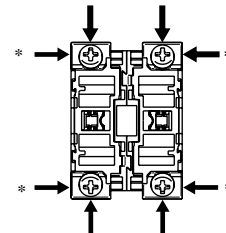

Terminal Wiring

Arrows indicate access directions for wiring.

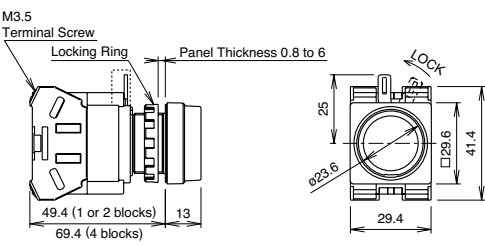

*Spring-up screw type only.

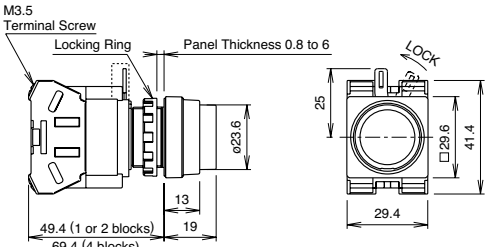
Round Button with Square Bezel Type

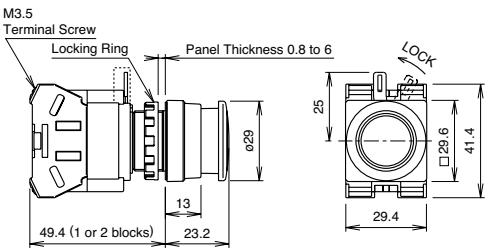
Shape	Operation Type	Contact	Type No.	① Button Color Code	Dimensions (Spring-up screw type)	
Round Flush with Square Bezel HW3B-M1 HW3B-A1 	Momentary	1NO	HW3B-M1⑥10①	Specify a button color code in place of ① in the Type No. B: black G: green R: red S: blue W: white Y: yellow		
		1NC	HW3B-M1⑥01①			
		1NO-1NC	HW3B-M1⑥11①			
		2NO	HW3B-M1⑥20①			
		2NC	HW3B-M1⑥02①			
		2NO-2NC	HW3B-M1⑥22①			
	Maintained	1NO	HW3B-A1⑥10①			
		1NC	HW3B-A1⑥01①			
		1NO-1NC	HW3B-A1⑥11①			
		2NO	HW3B-A1⑥20①			
		2NC	HW3B-A1⑥02①			
		2NO-2NC	HW3B-A1⑥22①			
Round Extended with Square Bezel HW3B-M2 HW3B-A2 	Momentary	1NO	HW3B-M2⑥10①		Specify a button color code in place of ① in the Type No. B: black G: green R: red S: blue W: white Y: yellow	
		1NC	HW3B-M2⑥01①			
		1NO-1NC	HW3B-M2⑥11①			
		2NO	HW3B-M2⑥20①			
		2NC	HW3B-M2⑥02①			
		2NO-2NC	HW3B-M2⑥22①			
	Maintained	1NO	HW3B-A2⑥10①			
		1NC	HW3B-A2⑥01①			
		1NO-1NC	HW3B-A2⑥11①			
		2NO	HW3B-A2⑥20①			
		2NC	HW3B-A2⑥02①			
		2NO-2NC	HW3B-A2⑥22①			
Ø29mm Mushroom with Square Bezel HW3B-M3 HW3B-A3 	Momentary	1NO	HW3B-M3⑥10①	Specify a button color code in place of ① in the Type No. B: black G: green R: red S: blue W: white Y: yellow		
		1NC	HW3B-M3⑥01①			
		1NO-1NC	HW3B-M3⑥11①			
		2NO	HW3B-M3⑥20①			
		2NC	HW3B-M3⑥02①			
		2NO-2NC	HW3B-M3⑥22①			
	Maintained	1NO	HW3B-A3⑥10①			
		1NC	HW3B-A3⑥01①			
		1NO-1NC	HW3B-A3⑥11①			
		2NO	HW3B-A3⑥20①			
		2NC	HW3B-A3⑥02①			
		2NO-2NC	HW3B-A3⑥22①			

- Specify a terminal style code in place of ⑥ in the Type No. F: Finger-safe (IP20), blank: Spring-up screw
- Pushbuttons with one or three contact blocks contain a dummy block.
- Other contact arrangements and gold-plated silver contacts are also available. See page 7.
- The depth of each finger-safe (IP20) contact block is 0.9 mm longer than that of a spring-up screw contact block.

Contact Block (Bottom View)

Spring-up screw type

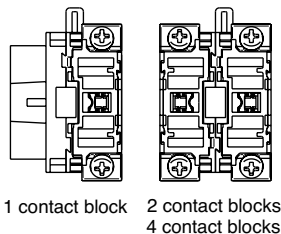





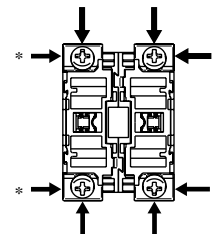



Terminal Wiring

Arrows indicate access directions for wiring.



Round Flush / Dome / Square Flush / Jumbo Dome Types

Shape	Lamp	Input Type	Type No.	② Lens/LED Color Code	③ Operating Voltage Code
Round Flush HW1P-1  (Photo: Full Voltage Type) 	Without Lamp	Full Voltage	HW1P-1⑥Q0②	A: amber G: green PW: pure white R: red S: blue W: white Y: yellow	Specify an operating voltage code in place of ③ in the Type No. H: 100/110V AC H2: 115/120V AC M: 200/220V AC M4: 230/240V AC S: 380V AC T: 400/440V AC T8: 480V AC
	LED	Transformer	HW1P-1⑥③2②		
		DC-DC Converter*	HW1P-1D2②		
	Incandescent	Transformer	HW1P-1⑥③5②	A: amber G: green R: red S: blue W: white	
Dome HW1P-2  (Photo: Full Voltage Type) 	Without Lamp	Full Voltage	HW1P-2⑥Q0②	A: amber G: green PW: pure white R: red S: blue W: white Y: yellow	
	LED	Transformer	HW1P-2⑥③2②		
		DC-DC Converter*	HW1P-2D2②		
	Incandescent	Transformer	HW1P-2⑥③5②	A: amber G: green R: red S: blue W: white	
Square Flush HW2P-1  (Photo: Transformer Type) 	Without Lamp	Full Voltage	HW2P-1⑥Q0②	A: amber G: green PW: pure white R: red S: blue W: white Y: yellow	
	LED	Transformer	HW2P-1③2②		
		DC-DC Converter*	HW2P-1D2②		
	Incandescent	Transformer	HW2P-1⑥③5②	A: amber G: green R: red S: blue W: white	
Jumbo Dome Pilot Light HW1P-5  	LED	Full Voltage	HW1P-5Q4②	A: amber G: green R: red S: blue W: white Y: yellow	Operating voltage: 24V AC/DC
	Incandescent		HW1P-5Q7②		

- Specify a lens/LED color code in place of ② in the Type No. Use a pure white LED lamp for yellow illumination.
- Specify a terminal style code in place of ⑥ in the Type No. F: Finger-safe (IP20), blank: Spring-up screw
- Only spring-up screw terminals are available on DC-DC converter types.
- Full voltage types do not contain a lamp. Order LED or incandescent lamps separately. For lamps, see page 51.
- LED illuminated transformer and DC-DC converter types contain an LED lamp (LSTD-6②, rated voltage 6V AC/DC).
- Incandescent illuminated transformer types contain an incandescent lamp (LS-6, rated voltage 6V AC/DC).
- *DC-DC converter types are not approved by UL, CSA, and TÜV, and not CE compliant (operating voltage 90 to 140V DC)
- Jumbo dome pilot lights contain an exclusive LED and incandescent lamps. See page 51.

∅22 HW Series Pilot Lights

Dimensions

•Pilot Light (except jumbo dome pilot light)

[Full Voltage Type]

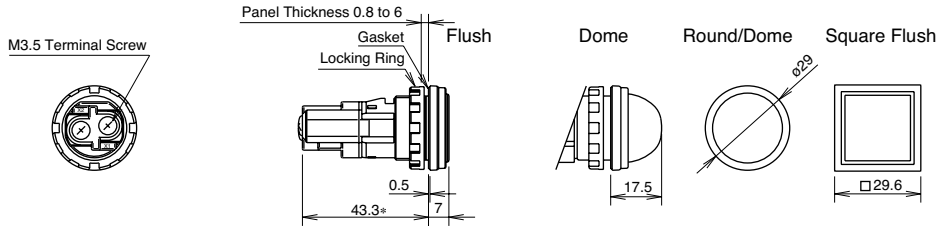

[Transformer Type]

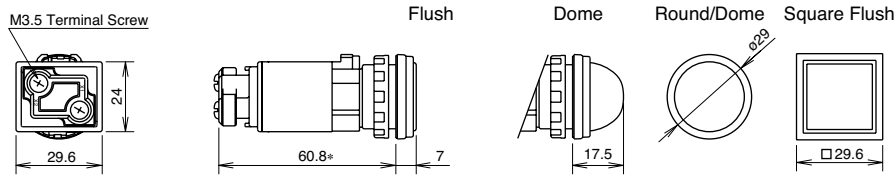

[DC-DC Converter Type]

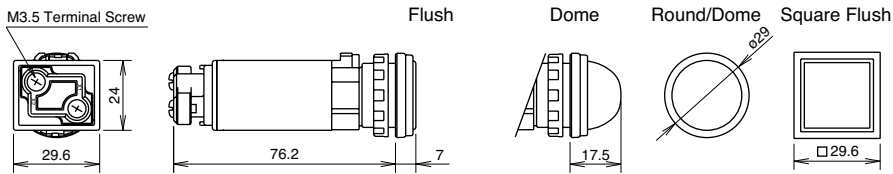

The above figures illustrate the spring-up screw types.

*The depths of finger-safe (IP20) types are as follows:

[Full Voltage Type] 44.7 mm

[Transformer Type] 72.1 mm

All dimensions in mm.

•Jumbo Dome Pilot Light

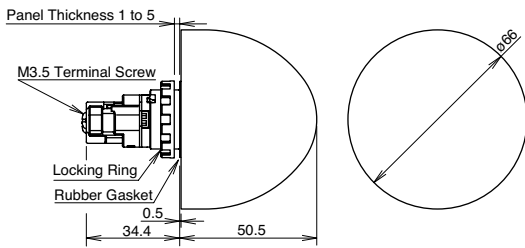

Mounting Hole Layout

•Pilot Light (except jumbo dome pilot light)

Close mounting on 30mm centers

Degree of protection: IP65

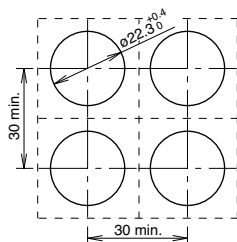

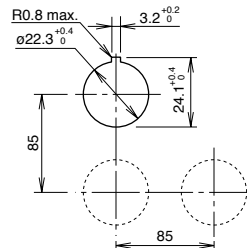

•Jumbo Dome Pilot Light



When mounting transformer or DC-DC converter type units on 30mm centers vertically and horizontally, keep the ambient temperature below 40°C.

Round Flush Illuminated Pushbutton

Shape	Operation Type	Lamp	Input Type	Contact	Type No.
Round Flush HW1L-M1 HW1L-A1  	Momentary	Without Lamp	Full Voltage	1NO	HW1L-M1⑥10Q0②
				1NC	HW1L-M1⑥01Q0②
				1NO-1NC	HW1L-M1⑥11Q0②
				2NO	HW1L-M1⑥20Q0②
				2NC	HW1L-M1⑥02Q0②
		2NO-2NC	HW1L-M1⑥22Q0②		
		LED	Transformer	1NO-1NC	HW1L-M1⑥11③2②
				2NO	HW1L-M1⑥20③2②
				2NC	HW1L-M1⑥02③2②
				2NO-2NC	HW1L-M1⑥22③2②
				DC-DC Converter*	1NO-1NC
		2NO	HW1L-M120D2②		
		2NC	HW1L-M102D2②		
		Incandescent	Transformer	2NO-2NC	HW1L-M122D2②
				1NO-1NC	HW1L-M1⑥11③5②
	2NO			HW1L-M1⑥20③5②	
	2NC			HW1L-M1⑥02③5②	
	2NO-2NC			HW1L-M1⑥22③5②	
	Maintained	Without Lamp	Full Voltage	1NO	HW1L-A1⑥10Q0②
				1NC	HW1L-A1⑥01Q0②
				1NO-1NC	HW1L-A1⑥11Q0②
				2NO	HW1L-A1⑥20Q0②
				2NC	HW1L-A1⑥02Q0②
		2NO-2NC	HW1L-A1⑥22Q0②		
		LED	Transformer	1NO-1NC	HW1L-A1⑥11③2②
				2NO	HW1L-A1⑥20③2②
				2NC	HW1L-A1⑥02③2②
				2NO-2NC	HW1L-A1⑥22③2②
				DC-DC Converter*	1NO-1NC
		2NO	HW1L-A120D2②		
2NC		HW1L-A102D2②			
Incandescent		Transformer	2NO-2NC	HW1L-A122D2②	
			1NO-1NC	HW1L-A1⑥11③5②	
	2NO		HW1L-A1⑥20③5②		
	2NC		HW1L-A1⑥02③5②		
	2NO-2NC		HW1L-A1⑥22③5②		



• **Designation Code**

Specify designation codes ②, ③, and ⑥ in the Type No.

LED Illuminated Type	Incandescent Illuminated Type	③ Operating Voltage Code	⑥ Terminal Style Code
② Lens/LED Color Code	② Lens Color Code		
Specify a lens/LED color code in place of ② in the Type No.	Specify a lens color code in place of ② in the Type No.	Specify an operating voltage code in place of ③ in the Type No.	Specify a terminal style code in place of ⑥ in the Type No.
A: amber G: green PW: pure white R: red S: blue W: white Y: yellow Use a pure white LED lamp for yellow illumination.	A: amber G: green R: red S: blue W: white	H: 100/110V AC H2: 115/120V AC M: 200/220V AC M4: 230/240V AC S: 380V AC T: 400/440V AC T8: 480V AC	F: Finger-safe (IP20) blank: Spring-up screw Only spring-up screw terminals are available on DC-DC converter types.

Note: Full voltage types do not contain a lamp. Order LED or incandescent lamps separately. For lamps, see page 51.
 LED illuminated transformer and DC-DC converter types contain an LED lamp (LSTD-6②, rated voltage 6V AC/DC).
 Incandescent illuminated transformer types contain an incandescent lamp (LS-6, rated voltage 6V AC/DC).
 * DC-DC converter types are not approved by UL, CSA, and TÜV, and not CE compliant (operating voltage 90 to 140V DC).

Round Extended Illuminated Pushbutton

Shape	Operation Type	Lamp	Input Type	Contact	Type No.	
 Round Extended HW1L-M2 HW1L-A2 	Momentary	Without Lamp	Full Voltage	1NO	HW1L-M2⑥10Q0②	
				1NC	HW1L-M2⑥01Q0②	
				1NO-1NC	HW1L-M2⑥11Q0②	
				2NO	HW1L-M2⑥20Q0②	
				2NC	HW1L-M2⑥02Q0②	
		2NO-2NC	HW1L-M2⑥22Q0②			
		1NO-1NC	HW1L-M2⑥11③2②			
		2NO	HW1L-M2⑥20③2②			
		2NC	HW1L-M2⑥02③2②			
		2NO-2NC	HW1L-M2⑥22③2②			
		1NO-1NC	HW1L-M211D2②			
		2NO	HW1L-M220D2②			
		2NC	HW1L-M202D2②			
		2NO-2NC	HW1L-M222D2②			
		Maintained	Without Lamp	Full Voltage	Full Voltage	1NO
	1NC					HW1L-A2⑥01Q0②
	1NO-1NC					HW1L-A2⑥11Q0②
	2NO					HW1L-A2⑥20Q0②
	2NC					HW1L-A2⑥02Q0②
	2NO-2NC		HW1L-A2⑥22Q0②			
	1NO-1NC		HW1L-A2⑥11③2②			
	2NO		HW1L-A2⑥20③2②			
	2NC		HW1L-A2⑥02③2②			
	2NO-2NC		HW1L-A222③2②			
	1NO-1NC		HW1L-A211D2②			
	2NO		HW1L-A220D2②			
	2NC		HW1L-A202D2②			
	2NO-2NC		HW1L-A222D2②			
	Incandescent		Transformer	Transformer	Transformer	1NO-1NC
		2NO				HW1L-A2⑥20③5②
2NC		HW1L-A2⑥02③5②				
2NO-2NC		HW1L-A2⑥22③5②				
2NO-2NC		HW1L-A2⑥22③5②				

• Designation Code

Specify designation codes ②, ③, and ⑥ in the Type No.

LED Illuminated Type	Incandescent Illuminated Type	③ Operating Voltage Code	⑥ Terminal Style Code
② Lens/LED Color Code	② Lens Color Code		
Specify a lens/LED color code in place of ② in the Type No.	Specify a lens color code in place of ② in the Type No.	Specify an operating voltage code in place of ③ in the Type No.	Specify a terminal style code in place of ⑥ in the Type No.
A: amber G: green PW: pure white R: red S: blue W: white Y: yellow Use a pure white LED lamp for yellow illumination.	A: amber G: green R: red S: blue W: white	H: 100/110V AC H2: 115/120V AC M: 200/220V AC M4: 230/240V AC S: 380V AC T: 400/440V AC T8: 480V AC	F: Finger-safe (IP20) blank: Spring-up screw Only spring-up screw terminals are available on DC-DC converter types.

Note: Full voltage types do not contain a lamp. Order LED or incandescent lamps separately. For lamps, see page 51.

LED illuminated transformer and DC-DC converter types contain an LED lamp (LSTD-6②, rated voltage 6V AC/DC).

Incandescent illuminated transformer types contain an incandescent lamp (LS-6, rated voltage 6V AC/DC).

* DC-DC converter types are not approved by UL, CSA, and TÜV, and not CE compliant (operating voltage 90 to 140V DC).

Round Extended with Full Shroud Illuminated Pushbutton

Shape	Operation Type	Lamp	Input Type	Contact	Type No.
	Momentary	Without Lamp	Full Voltage	1NO	HW1L-MF2⑥10Q0②
				1NC	HW1L-MF2⑥01Q0②
				1NO-1NC	HW1L-MF2⑥11Q0②
				2NO	HW1L-MF2⑥20Q0②
				2NC	HW1L-MF2⑥02Q0②
		2NO-2NC	HW1L-MF2⑥22Q0②		
		LED	Transformer	1NO-1NC	HW1L-MF2⑥11③2②
				2NO	HW1L-MF2⑥20③2②
				2NC	HW1L-MF2⑥02③2②
				2NO-2NC	HW1L-MF2⑥22③2②
				DC-DC Converter*	1NO-1NC
		2NO	HW1L-MF220D2②		
		2NC	HW1L-MF202D2②		
		2NO-2NC	HW1L-MF222D2②		
		Incandescent	Transformer		1NO-1NC
	2NO			HW1L-MF2⑥20③5②	
	2NC			HW1L-MF2⑥02③5②	
	2NO-2NC			HW1L-MF2⑥22③5②	
	Maintained			Without Lamp	Full Voltage
		1NC	HW1L-AF2⑥01Q0②		
		1NO-1NC	HW1L-AF2⑥11Q0②		
		2NO	HW1L-AF2⑥20Q0②		
		2NC	HW1L-AF2⑥02Q0②		
		2NO-2NC	HW1L-AF2⑥22Q0②		
		LED	Transformer	1NO-1NC	HW1L-AF2⑥11③2②
				2NO	HW1L-AF2⑥20③2②
				2NC	HW1L-AF2⑥02③2②
				2NO-2NC	HW1L-AF2⑥22③2②
				DC-DC Converter*	1NO-1NC
		2NO	HW1L-AF220D2②		
2NC		HW1L-AF202D2②			
2NO-2NC		HW1L-AF222D2②			
Incandescent		Transformer	1NO-1NC		HW1L-AF2⑥11③5②
	2NO		HW1L-AF2⑥20③5②		
	2NC		HW1L-AF2⑥02③5②		
	2NO-2NC		HW1L-AF2⑥22③5②		



• Designation Code

Specify designation codes ②, ③, and ⑥ in the Type No.

LED Illuminated Type	Incandescent Illuminated Type	③ Operating Voltage Code	⑥ Terminal Style Code
② Lens/LED Color Code	② Lens Color Code		
Specify a lens/LED color code in place of ② in the Type No. A: amber G: green PW: pure white R: red S: blue W: white Y: yellow Use a pure white LED lamp for yellow illumination.	Specify a lens color code in place of ② in the Type No. A: amber G: green R: red S: blue W: white	Specify an operating voltage code in place of ③ in the Type No. H: 100/110V AC H2: 115/120V AC M: 200/220V AC M4: 230/240V AC S: 380V AC T: 400/440V AC T8: 480V AC	Specify a terminal style code in place of ⑥ in the Type No. F: Finger-safe (IP20) blank: Spring-up screw Only spring-up screw terminals are available on DC-DC converter types.

Note: Full voltage types do not contain a lamp. Order LED or incandescent lamps separately. For lamps, see page 51.
 LED illuminated transformer and DC-DC converter types contain an LED lamp (LSTD-6②, rated voltage 6V AC/DC).
 Incandescent illuminated transformer types contain an incandescent lamp (LS-6, rated voltage 6V AC/DC).
 * DC-DC converter types are not approved by UL, CSA, and TÜV, and not CE compliant (operating voltage 90 to 140V DC).

Square Flush Illuminated Pushbutton

Shape	Operation Type	Lamp	Input Type	Contact	Type No.	
Square Flush HW2L-M1 HW2L-A1  	Momentary	Without Lamp	Full Voltage	1NO	HW2L-M1⑥10Q0②	
				1NC	HW2L-M1⑥01Q0②	
				1NO-1NC	HW2L-M1⑥11Q0②	
				2NO	HW2L-M1⑥20Q0②	
				2NC	HW2L-M1⑥02Q0②	
				2NO-2NC	HW2L-M1⑥22Q0②	
		LED	Transformer	1NO-1NC	HW2L-M1⑥11③2②	
				2NO	HW2L-M1⑥20③2②	
				2NC	HW2L-M1⑥02③2②	
			DC-DC Converter*	2NO-2NC	HW2L-M1⑥22③2②	
				1NO-1NC	HW2L-M111D2②	
				2NO	HW2L-M120D2②	
		Incandescent	Transformer	2NC	HW2L-M102D2②	
				2NO-2NC	HW2L-M122D2②	
				1NO-1NC	HW2L-M1⑥11③5②	
	2NO		HW2L-M1⑥20③5②			
	2NC		HW2L-M1⑥02③5②			
	2NO-2NC		HW2L-M1⑥22③5②			
	Maintained		Without Lamp	Full Voltage	1NO	HW2L-A1⑥10Q0②
					1NC	HW2L-A1⑥01Q0②
					1NO-1NC	HW2L-A1⑥11Q0②
		2NO			HW2L-A1⑥20Q0②	
		2NC			HW2L-A1⑥02Q0②	
		2NO-2NC			HW2L-A1⑥22Q0②	
		LED	Transformer	1NO-1NC	HW2L-A1⑥11③2②	
				2NO	HW2L-A1⑥20③2②	
				2NC	HW2L-A1⑥02③2②	
			DC-DC Converter*	2NO-2NC	HW2L-A1⑥22③2②	
				1NO-1NC	HW2L-A111D2②	
				2NO	HW2L-A120D2②	
Incandescent		Transformer	2NC	HW2L-A102D2②		
			2NO-2NC	HW2L-A122D2②		
			1NO-1NC	HW2L-A1⑥11③5②		
2NO	HW2L-A1⑥20③5②					
2NC	HW2L-A1⑥02③5②					
2NO-2NC	HW2L-A1⑥22③5②					

• **Designation Code**

Specify designation codes ②, ③, and ⑥ in the Type No.

LED Illuminated Type	Incandescent Illuminated Type	③ Operating Voltage Code	⑥ Terminal Style Code
② Lens/LED Color Code	② Lens Color Code		
Specify a lens/LED color code in place of ② in the Type No.	Specify a lens color code in place of ② in the Type No.	Specify an operating voltage code in place of ③ in the Type No.	Specify a terminal style code in place of ⑥ in the Type No.
A: amber G: green PW: pure white R: red S: blue W: white Y: yellow Use a pure white LED lamp for yellow illumination.	A: amber G: green R: red S: blue W: white	H: 100/110V AC H2: 115/120V AC M: 200/220V AC M4: 230/240V AC S: 380V AC T: 400/440V AC T8: 480V AC	F: Finger-safe (IP20) blank: Spring-up screw Only spring-up screw terminals are available on DC-DC converter types.



Note: Full voltage types do not contain a lamp. Order LED or incandescent lamps separately. For lamps, see page 51.

LED illuminated transformer and DC-DC converter types contain an LED lamp (LSTD-6②, rated voltage 6V AC/DC).

Incandescent illuminated transformer types contain an incandescent lamp (LS-6, rated voltage 6V AC/DC).

* DC-DC converter types are not approved by UL, CSA, and TÜV, and not CE compliant (operating voltage 90 to 140V DC).

Round Flush with Square Bezel Illuminated Pushbutton

Shape	Operation Type	Lamp	Input Type	Contact	Type No.	
Round Flush with Square Bezel HW3L-M1 HW3L-A1  	Momentary	Without Lamp	Full Voltage	1NO	HW3L-M1⑥10Q0②	
				1NC	HW3L-M1⑥01Q0②	
				1NO-1NC	HW3L-M1⑥11Q0②	
				2NO	HW3L-M1⑥20Q0②	
				2NC	HW3L-M1⑥02Q0②	
				2NO-2NC	HW3L-M1⑥22Q0②	
				1NO-1NC	HW3L-M1⑥11③2②	
				2NO	HW3L-M1⑥20③2②	
		2NC	HW3L-M1⑥02③2②			
		2NO-2NC	HW3L-M1⑥22③2②			
		LED	Transformer	1NO-1NC	HW3L-M111D2②	
				2NO	HW3L-M1⑥20③2②	
				2NC	HW3L-M1⑥02③2②	
				2NO-2NC	HW3L-M1⑥22③2②	
		DC-DC Converter*	Transformer	1NO-1NC	HW3L-M111D2②	
				2NO	HW3L-M120D2②	
	2NC			HW3L-M102D2②		
	2NO-2NC			HW3L-M122D2②		
	Incandescent	Transformer	1NO-1NC	HW3L-M1⑥11③5②		
			2NO	HW3L-M1⑥20③5②		
			2NC	HW3L-M1⑥02③5②		
			2NO-2NC	HW3L-M1⑥22③5②		
			Without Lamp	Full Voltage	1NO	HW3L-A1⑥10Q0②
					1NC	HW3L-A1⑥01Q0②
					1NO-1NC	HW3L-A1⑥11Q0②
					2NO	HW3L-A1⑥20Q0②
	2NC	HW3L-A1⑥02Q0②				
	2NO-2NC	HW3L-A1⑥22Q0②				
1NO-1NC	HW3L-A1⑥11③2②					
2NO	HW3L-A1⑥20③2②					
2NC	HW3L-A1⑥02③2②					
2NO-2NC	HW3L-A1⑥22③2②					
LED	Transformer	1NO-1NC	HW3L-A111D2②			
		2NO	HW3L-A1⑥20③2②			
		2NC	HW3L-A1⑥02③2②			
		2NO-2NC	HW3L-A1⑥22③2②			
	DC-DC Converter*	Transformer	1NO-1NC	HW3L-A111D2②		
			2NO	HW3L-A120D2②		
			2NC	HW3L-A102D2②		
			2NO-2NC	HW3L-A122D2②		
Incandescent	Transformer	1NO-1NC	HW3L-A1⑥11③5②			
		2NO	HW3L-A1⑥20③5②			
		2NC	HW3L-A1⑥02③5②			
		2NO-2NC	HW3L-A1⑥22③5②			
Maintained	Without Lamp	Full Voltage	1NO	HW3L-A1⑥10Q0②		
			1NC	HW3L-A1⑥01Q0②		
			1NO-1NC	HW3L-A1⑥11Q0②		
			2NO	HW3L-A1⑥20Q0②		
			2NC	HW3L-A1⑥02Q0②		
			2NO-2NC	HW3L-A1⑥22Q0②		
			1NO-1NC	HW3L-A1⑥11③2②		
			2NO	HW3L-A1⑥20③2②		
	2NC	HW3L-A1⑥02③2②				
	2NO-2NC	HW3L-A1⑥22③2②				
	LED	Transformer	1NO-1NC	HW3L-A111D2②		
			2NO	HW3L-A120D2②		
			2NC	HW3L-A102D2②		
			2NO-2NC	HW3L-A122D2②		
		DC-DC Converter*	Transformer	1NO-1NC	HW3L-A111D2②	
				2NO	HW3L-A120D2②	
2NC				HW3L-A102D2②		
2NO-2NC				HW3L-A122D2②		
Incandescent	Transformer	1NO-1NC	HW3L-A1⑥11③5②			
		2NO	HW3L-A1⑥20③5②			
		2NC	HW3L-A1⑥02③5②			
		2NO-2NC	HW3L-A1⑥22③5②			



• **Designation Code**

Specify designation codes ②, ③, and ⑥ in the Type No.

LED Illuminated Type	Incandescent Illuminated Type	③ Operating Voltage Code	⑥ Terminal Style Code
② Lens/LED Color Code	② Lens Color Code		
Specify a lens/LED color code in place of ② in the Type No.	Specify a lens color code in place of ② in the Type No.	Specify an operating voltage code in place of ③ in the Type No.	Specify a terminal style code in place of ⑥ in the Type No.
A: amber G: green PW: pure white R: red S: blue W: white Y: yellow Use a pure white LED lamp for yellow illumination.	A: amber G: green R: red S: blue W: white	H: 100/110V AC H2: 115/120V AC M: 200/220V AC M4: 230/240V AC S: 380V AC T: 400/440V AC T8: 480V AC	F: Finger-safe (IP20) blank: Spring-up screw Only spring-up screw terminals are available on DC-DC converter types.

Note: Full voltage types do not contain a lamp. Order LED or incandescent lamps separately. For lamps, see page 51.
 LED illuminated transformer and DC-DC converter types contain an LED lamp (LSTD-6②, rated voltage 6V AC/DC).
 Incandescent illuminated transformer types contain an incandescent lamp (LS-6, rated voltage 6V AC/DC).
 * DC-DC converter types are not approved by UL, CSA, and TÜV, and not CE compliant (operating voltage 90 to 140V DC).

Mushroom (ø29mm) Illuminated Pushbutton

Shape	Operation Type	Lamp	Input Type	Contact	Type No.
 ø29mm Mushroom HW1L-M3 HW1L-A3 	Momentary	Without Lamp	Full Voltage	1NO	HW1L-M3⑥10Q0②
				1NC	HW1L-M3⑥01Q0②
				1NO-1NC	HW1L-M3⑥11Q0②
				2NO	HW1L-M3⑥20Q0②
				2NC	HW1L-M3⑥02Q0②
		2NO-2NC	HW1L-M3⑥22Q0②		
		1NO-1NC	HW1L-M3⑥11③2②		
		2NO	HW1L-M3⑥20③2②		
		2NC	HW1L-M3⑥02③2②		
		2NO-2NC	HW1L-M3⑥22③2②		
		LED	Transformer	1NO-1NC	HW1L-M311D2②
				2NO	HW1L-M320D2②
				2NC	HW1L-M302③2②
				2NO-2NC	HW1L-M3⑥22③2②
				DC-DC Converter*	1NO-1NC
	2NO	HW1L-M320D2②			
	2NC	HW1L-M302D2②			
	2NO-2NC	HW1L-M322D2②			
	Incandescent	Transformer	1NO-1NC		HW1L-M3⑥11③5②
			2NO	HW1L-M3⑥20③5②	
			2NC	HW1L-M3⑥02③5②	
			2NO-2NC	HW1L-M3⑥22③5②	
			Maintained	Without Lamp	Full Voltage
	1NC	HW1L-A3⑥01Q0②			
	1NO-1NC	HW1L-A3⑥11Q0②			
	2NO	HW1L-A3⑥20Q0②			
	2NC	HW1L-A3⑥02Q0②			
	2NO-2NC	HW1L-A3⑥22Q0②			
	LED	Transformer		1NO-1NC	HW1L-A3⑥11③2②
				2NO	HW1L-A3⑥20③2②
2NC				HW1L-A3⑥02③2②	
2NO-2NC				HW1L-A3⑥22③2②	
DC-DC Converter*				1NO-1NC	HW1L-A311D2②
	2NO	HW1L-A320D2②			
	2NC	HW1L-A302D2②			
	2NO-2NC	HW1L-A322D2②			
	Incandescent	Transformer		1NO-1NC	HW1L-A3⑥11③5②
2NO			HW1L-A3⑥20③5②		
2NC			HW1L-A3⑥02③5②		
2NO-2NC			HW1L-A3⑥22③5②		





• **Designation Code**

Specify designation codes ②, ③, and ⑥ in the Type No.

LED Illuminated Type	Incandescent Illuminated Type	③ Operating Voltage Code	⑥ Terminal Style Code
② Lens/LED Color Code	② Lens Color Code		
Specify a lens/LED color code in place of ② in the Type No.	Specify a lens color code in place of ② in the Type No.	Specify an operating voltage code in place of ③ in the Type No.	Specify a terminal style code in place of ⑥ in the Type No.
A: amber G: green PW: pure white R: red S: blue W: white Y: yellow Use a pure white LED lamp for yellow illumination.	A: amber G: green R: red S: blue W: white	H: 100/110V AC H2: 115/120V AC M: 200/220V AC M4: 230/240V AC S: 380V AC T: 400/440V AC T8: 480V AC	F: Finger-safe (IP20) blank: Spring-up screw Only spring-up screw terminals are available on DC-DC converter types.

Note: Full voltage types do not contain a lamp. Order LED or incandescent lamps separately. For lamps, see page 51.
 LED illuminated transformer and DC-DC converter types contain an LED lamp (LSTD-6②, rated voltage 6V AC/DC).
 Incandescent illuminated transformer types contain an incandescent lamp (LS-6, rated voltage 6V AC/DC).
 * DC-DC converter types are not approved by UL, CSA, and TÜV, and not CE compliant (operating voltage 90 to 140V DC).

Mushroom (ø29mm) with Square Bezel Illuminated Pushbutton

Shape	Operation Type	Lamp	Input Type	Contact	Type No.	
<div style="display: flex; flex-direction: column; align-items: center;">  <div style="display: flex; justify-content: center; gap: 10px; margin-top: 10px;">     </div> </div>	Momentary	Without Lamp	Full Voltage	1NO	HW3L-M3⑥10Q0②	
				1NC	HW3L-M3⑥01Q0②	
				1NO-1NC	HW3L-M3⑥11Q0②	
				2NO	HW3L-M3⑥20Q0②	
				2NC	HW3L-M3⑥02Q0②	
				2NO-2NC	HW3L-M3⑥22Q0②	
				1NO-1NC	HW3L-M3⑥11③2②	
				2NO	HW3L-M3⑥20③2②	
				2NC	HW3L-M3⑥02③2②	
		2NO-2NC	HW3L-M3⑥22③2②			
		LED	Transformer	1NO-1NC	HW3L-M311D2②	
				2NO	HW3L-M320D2②	
				2NC	HW3L-M302D2②	
			DC-DC Converter*	2NO-2NC	HW3L-M322D2②	
				1NO-1NC	HW3L-M3⑥11③5②	
				2NO	HW3L-M3⑥20③5②	
				2NC	HW3L-M3⑥02③5②	
				2NO-2NC	HW3L-M3⑥22③5②	
	2NO-2NC			HW3L-M322D2②		
	Incandescent	Transformer	1NO-1NC	HW3L-M3⑥11③5②		
			2NO	HW3L-M3⑥20③5②		
			2NC	HW3L-M3⑥02③5②		
		2NO-2NC	HW3L-M3⑥22③5②			
		Maintained	Without Lamp	Full Voltage	1NO	HW3L-A3⑥10Q0②
					1NC	HW3L-A3⑥01Q0②
					1NO-1NC	HW3L-A3⑥11Q0②
					2NO	HW3L-A3⑥20Q0②
					2NC	HW3L-A3⑥02Q0②
	2NO-2NC				HW3L-A3⑥22Q0②	
	1NO-1NC				HW3L-A3⑥11③2②	
	2NO				HW3L-A3⑥20③2②	
	2NC				HW3L-A3⑥02③2②	
	LED		Transformer	2NO-2NC	HW3L-A3⑥22③2②	
				1NO-1NC	HW3L-A311D2②	
				2NO	HW3L-A320D2②	
			DC-DC Converter*	2NC	HW3L-A302D2②	
2NO-2NC				HW3L-A322D2②		
1NO-1NC				HW3L-A3⑥11③5②		
2NO				HW3L-A3⑥20③5②		
2NC				HW3L-A3⑥02③5②		
2NO-2NC				HW3L-A3⑥22③5②		
Incandescent	Transformer	2NO	HW3L-A3⑥20③5②			
		2NC	HW3L-A3⑥02③5②			
		2NO-2NC	HW3L-A3⑥22③5②			

• Designation Code

Specify designation codes ②, ③, and ⑥ in the Type No.

LED Illuminated Type	Incandescent Illuminated Type	③ Operating Voltage Code	⑥ Terminal Style Code
② Lens/LED Color Code	② Lens Color Code		
Specify a lens/LED color code in place of ② in the Type No.	Specify a lens color code in place of ② in the Type No.	Specify an operating voltage code in place of ③ in the Type No.	Specify a terminal style code in place of ⑥ in the Type No.
A: amber G: green PW: pure white R: red S: blue W: white Y: yellow Use a pure white LED lamp for yellow illumination.	A: amber G: green R: red S: blue W: white	H: 100/110V AC H2: 115/120V AC M: 200/220V AC M4: 230/240V AC S: 380V AC T: 400/440V AC T8: 480V AC	F: Finger-safe (IP20) blank: Spring-up screw Only spring-up screw terminals are available on DC-DC converter types.

Note: Full voltage types do not contain a lamp. Order LED or incandescent lamps separately. For lamps, see page 51.
 LED illuminated transformer and DC-DC converter types contain an LED lamp (LSTD-6②, rated voltage 6V AC/DC).
 Incandescent illuminated transformer types contain an incandescent lamp (LS-6, rated voltage 6V AC/DC).
 * DC-DC converter types are not approved by UL, CSA, and TÜV, and not CE compliant (operating voltage 90 to 140V DC).

Mushroom (ø40mm) Illuminated Pushbutton

Shape	Operation Type	Lamp	Input Type	Contact	Type No.
 <p>ø40mm Mushroom HW1L-M4 HW1L-A4</p> <p>UL LISTED SF A CE CC</p>	Momentary	Without Lamp	Full Voltage	1NO	HW1L-M4⑥10Q0②
				1NC	HW1L-M4⑥01Q0②
				1NO-1NC	HW1L-M4⑥11Q0②
				2NO	HW1L-M4⑥20Q0②
				2NC	HW1L-M4⑥02Q0②
		2NO-2NC	HW1L-M4⑥22Q0②		
		LED	Transformer	1NO-1NC	HW1L-M4⑥11③2②
				2NO	HW1L-M4⑥20③2②
				2NC	HW1L-M4⑥02③2②
				2NO-2NC	HW1L-M4⑥22③2②
				DC-DC Converter*	1NO-1NC
		2NO	HW1L-M420D2②		
		2NC	HW1L-M402D2②		
		2NO-2NC	HW1L-M422D2②		
		Incandescent	Transformer		1NO-1NC
	2NO			HW1L-M4⑥20③5②	
	2NC			HW1L-M4⑥02③5②	
	2NO-2NC			HW1L-M4⑥22③5②	
	Maintained			Without Lamp	Full Voltage
		1NC	HW1L-A4⑥01Q0②		
		1NO-1NC	HW1L-A4⑥11Q0②		
		2NO	HW1L-A4⑥20Q0②		
		2NC	HW1L-A4⑥02Q0②		
		2NO-2NC	HW1L-A4⑥22Q0②		
		LED	Transformer	1NO-1NC	HW1L-A4⑥11③2②
				2NO	HW1L-A4⑥20③2②
				2NC	HW1L-A4⑥02③2②
				2NO-2NC	HW1L-A4⑥22③2②
				DC-DC Converter*	1NO-1NC
		2NO	HW1L-A420D2②		
2NC		HW1L-A402D2②			
2NO-2NC		HW1L-A422D2②			
Incandescent		Transformer	1NO-1NC		HW1L-A4⑥11③5②
	2NO		HW1L-A4⑥20③5②		
	2NC		HW1L-A4⑥02③5②		
	2NO-2NC		HW1L-A4⑥22③5②		

• **Designation Code**

Specify designation codes ②, ③, and ⑥ in the Type No.

LED Illuminated Type	Incandescent Illuminated Type	③ Operating Voltage Code	⑥ Terminal Style Code
② Lens/LED Color Code	② Lens Color Code		
Specify a lens/LED color code in place of ② in the Type No.	Specify a lens color code in place of ② in the Type No.	Specify an operating voltage code in place of ③ in the Type No.	Specify a terminal style code in place of ⑥ in the Type No.
A: amber G: green PW: pure white R: red S: blue W: white Y: yellow Use a pure white LED lamp for yellow illumination.	A: amber G: green R: red S: blue W: white	H: 100/110V AC H2: 115/120V AC M: 200/220V AC M4: 230/240V AC S: 380V AC T: 400/440V AC T8: 480V AC	F: Finger-safe (IP20) blank: Spring-up screw Only spring-up screw terminals are available on DC-DC converter types.

Note: Full voltage types do not contain a lamp. Order LED or incandescent lamps separately. For lamps, see page 51.

LED illuminated transformer and DC-DC converter types contain an LED lamp (LSTD-6②, rated voltage 6V AC/DC).

Incandescent illuminated transformer types contain an incandescent lamp (LS-6, rated voltage 6V AC/DC).

* DC-DC converter types are not approved by UL, CSA, and TÜV, and not CE compliant (operating voltage 90 to 140V DC).

Dimensions

• Full Voltage Type

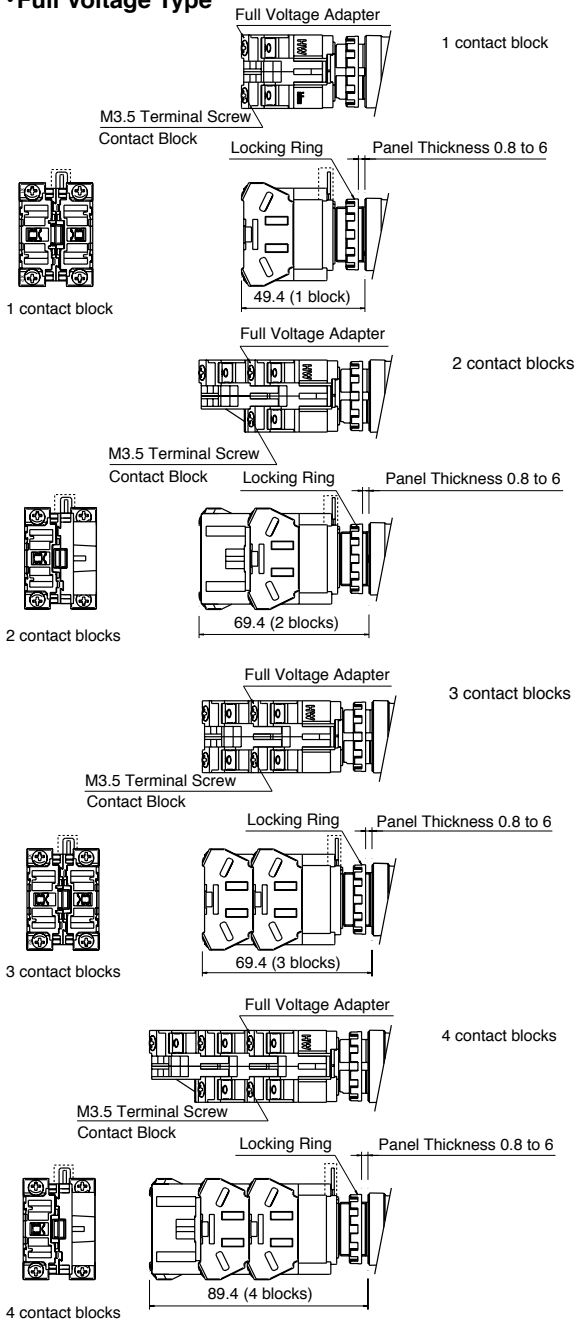

• Transformer Type (240V AC maximum)

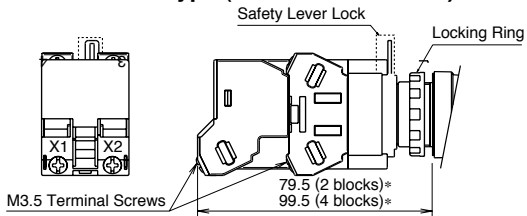

• Transformer Type (380V AC minimum)

• DC-DC Converter Type

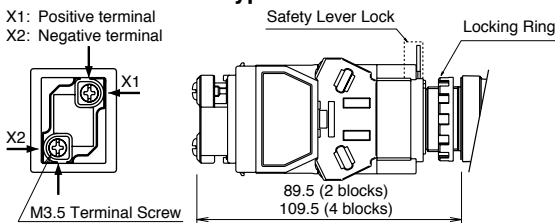

• Operator

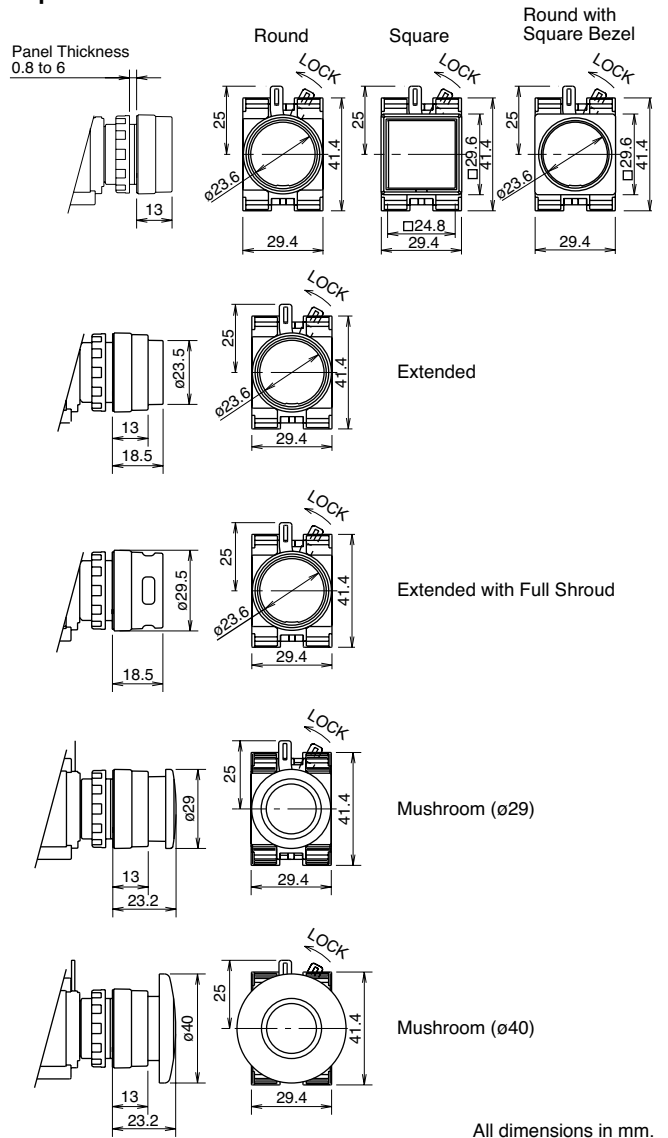

Terminal Wiring

Arrows indicate access directions for wiring.

Spring-up screw type

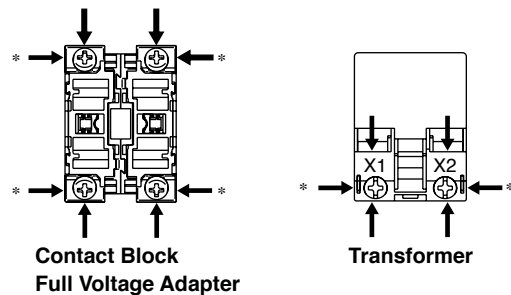

*Spring-up screw type only

The above figures illustrate the spring-up screw types.





The depth of each finger-safe (IP20) contact block is 0.9 mm longer than that of a spring-up screw contact block.

*The depths of finger-safe (IP20) types are as follows:

Transformer Type (240V AC maximum): 89.5 (2 blocks)
109.5 (4 blocks)

Dual Pushbuttons

• Without Pilot Light

Operation Type	Button Style	Contact Arrangement		Type No.	④ Button Color Code	⑤ Legend Code
		Top Button	Bottom Button			
Momentary	Flush (top) Flush (bottom)  	1NO	1NC	HW7D-B11⑥1001④⑤	GR: Green (top) Red (bottom) WB: White (top) Black (bottom)	Blank: Without legend 1: I/ON (top) O/OFF (bottom)
		1NO	1NO	HW7D-B11⑥1010④⑤		
		1NO-1NC	1NO-1NC	HW7D-B11⑥1111④⑤		
		2NO	2NC	HW7D-B11⑥2002④⑤		
	Flush (top) Extended (bottom)  	2NO	2NO	HW7D-B11⑥2020④⑤		
		1NO	1NC	HW7D-B12⑥1001④⑤		
		1NO	1NO	HW7D-B12⑥1010④⑤		
		1NO-1NC	1NO-1NC	HW7D-B12⑥1111④⑤		
		2NO	2NC	HW7D-B12⑥2002④⑤		
		2NO	2NO	HW7D-B12⑥2020④⑤		
Interlock	Flush (top) Flush (bottom)  	1NO	1NC	HW7D-B21⑥1001④⑤	WB: White (top) Black (bottom)	Blank: Without legend 1: I/ON (top) O/OFF (bottom)
		1NO	1NO	HW7D-B21⑥1010④⑤		
		1NO-1NC	1NO-1NC	HW7D-B21⑥1111④⑤		
		2NO	2NC	HW7D-B21⑥2002④⑤		
	Flush (top) Extended (bottom)  	2NO	2NO	HW7D-B21⑥2020④⑤		
		1NO	1NC	HW7D-B22⑥1001④⑤		
		1NO	1NO	HW7D-B22⑥1010④⑤		
		1NO-1NC	1NO-1NC	HW7D-B22⑥1111④⑤		
		2NO	2NC	HW7D-B22⑥2002④⑤		
		2NO	2NO	HW7D-B22⑥2020④⑤		

• Specify a terminal style code in place of ⑥ in the Type No. F: Finger-safe (IP20), blank: Spring-up screw

Momentary: Two independent momentary switches are contained in one unit.

The contact operates when the button is pressed. When the button is released, the contact goes back to the original position.

Interlock: Momentary operation. When one of the buttons are pressed, the other button cannot be operated.

Do not operate top and bottom buttons at the same time. Operating the buttons at the same time may lead to malfunctions.

Other contact arrangements and gold-plated silver contacts are also available. See page 8.

Dual Pushbuttons

• **With Pilot Light**

Operation Type	Lamp	Input Type	Contact Arrangement		Type No.			
			Top Button	Bottom Button				
Momentary	Without Lamp	Full Voltage	1NO	1NC	HW7D-L1①⑥1001Q0W④⑤			
			1NO	1NO	HW7D-L1①⑥1010Q0W④⑤			
			1NO-1NC	1NO-1NC	HW7D-L1①⑥1111Q0W④⑤			
			2NO	2NC	HW7D-L1①⑥2002Q0W④⑤			
			2NO	2NO	HW7D-L1①⑥2020Q0W④⑤			
			LED	Transformer	1NO	1NC	HW7D-L1①⑥1001②2③④⑤	
					1NO	1NO	HW7D-L1①⑥1010②2③④⑤	
					1NO-1NC	1NO-1NC	HW7D-L1①⑥1111②2③④⑤	
	2NO	2NC			HW7D-L1①⑥2002②2③④⑤			
	2NO	2NO			HW7D-L1①⑥2020②2③④⑤			
	DC-DC Converter				1NO	1NC	HW7D-L1①1001D2③④⑤	
					1NO	1NO	HW7D-L1①1010D2③④⑤	
					1NO-1NC	1NO-1NC	HW7D-L1①1111D2③④⑤	
			2NO	2NC	HW7D-L1①2002D2③④⑤			
			2NO	2NO	HW7D-L1①2020D2③③⑤			
			Incandescent	Transformer	1NO	1NC	HW7D-L1①⑥1001②5W④⑤	
					1NO	1NO	HW7D-L1①⑥1010②5W④⑤	
					1NO-1NC	1NO-1NC	HW7D-L1①⑥1111②5W④⑤	
	2NO	2NC			HW7D-L1①⑥2002②5W④⑤			
	2NO	2NO			HW7D-L1①⑥2020②5W④⑤			
	Interlock	Without Lamp			Full Voltage	1NO	1NC	HW7D-L2①⑥1001Q0W④⑤
						1NO	1NO	HW7D-L2①⑥1010Q0W④⑤
						1NO-1NC	1NO-1NC	HW7D-L2①⑥1111Q0W④⑤
			2NO	2NC		HW7D-L2①⑥2002Q0W④⑤		
2NO			2NO	HW7D-L2①⑥2020Q0W④⑤				
LED			Transformer	1NO		1NC	HW7D-L2①⑥1001②2③④⑤	
				1NO		1NO	HW7D-L2①⑥1010②2③④⑤	
				1NO-1NC		1NO-1NC	HW7D-L2①⑥1111②2③④⑤	
		2NO		2NC	HW7D-L2①⑥2002②2③④⑤			
		2NO		2NO	HW7D-L2①⑥2020②2③④⑤			
		DC-DC Converter			1NO	1NC	HW7D-L2①1001D2③④⑤	
					1NO	1NO	HW7D-L2①1010D2③④⑤	
					1NO-1NC	1NO-1NC	HW7D-L2①1111D2③④⑤	
2NO			2NC		HW7D-L2①2002D2③④⑤			
2NO			2NO		HW7D-L2①2020D2③④⑤			
Incandescent			Transformer		1NO	1NC	HW7D-L2①⑥1001②5W④⑤	
					1NO	1NO	HW7D-L2①⑥1010②5W④⑤	
					1NO-1NC	1NO-1NC	HW7D-L2①⑥1111②5W④⑤	
		2NO		2NC	HW7D-L2①⑥2002②5W④⑤			
		2NO		2NO	HW7D-L2①⑥2020②5W④⑤			

• **Designation Codes**

Specify designation codes ① to ⑥ in the Type No.

① Button Style Code	② Operating Voltage Code	③ Lamp Color Code	④ Button Color Code	⑤ Legend Code	⑥ Terminal Style Code
 <p>1: Flush (top) Flush (bottom)</p>	<p>H: 100/110V AC H2: 115/120V AC M: 200/220V AC M4: 230/240V AC S: 380V AC T: 400/440V AC T8: 480V AC</p>	<p>A: amber G: green R: red S: blue W: white</p> <p>The lens is white only.</p>	<p>GR: Green (top) Red (bottom)</p> <p>WB: White (top) Black (bottom)</p>	<p>Blank: Without legend</p> <p>1: I/ON (top) O/OFF (bottom)</p>	<p>F: Finger-safe (IP20) blank: Spring-up screw</p> <p>Only spring-up screw terminals are available on DC-DC converter types.</p>

Note: Full voltage types do not contain a lamp. Order LED or incandescent lamps separately. For lamps, see page 51.
LED illuminated transformer and DC-DC converter types contain an LED lamp (LSTD-6③, rated voltage 6V AC/DC).
Incandescent illuminated transformer types contain an incandescent lamp (LS-6, rated voltage 6V AC/DC).

∅22 HW Series Dual Pushbuttons

Dimensions

Without Pilot Light

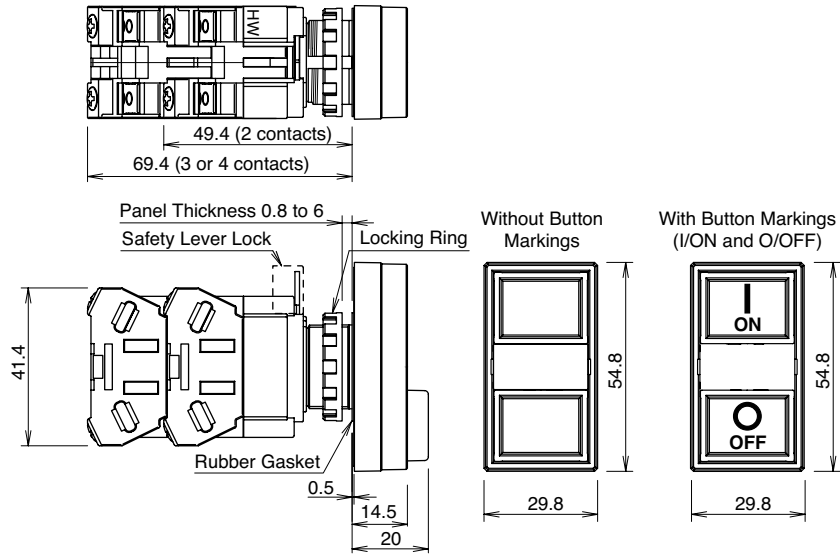

With Pilot Light

• Full Voltage

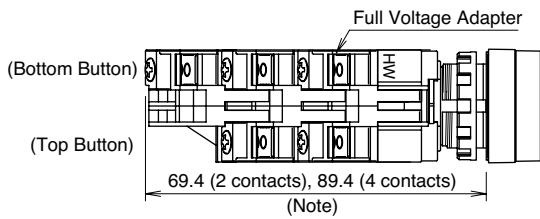

Note: The depth of 3-contact type depends on the combination of contact blocks at top and bottom pushbuttons

Top Button	1 contact block	2 contact blocks
Bottom Button	2 contact blocks	1 contact block
Depth	89.4 mm	69.4 mm

• Transformer (240V AC maximum)

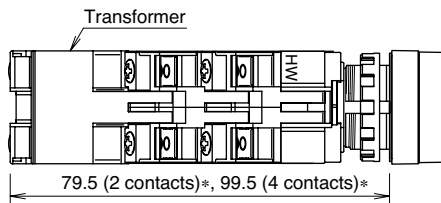

• Transformer (380V AC minimum)

• DC-DC Converter

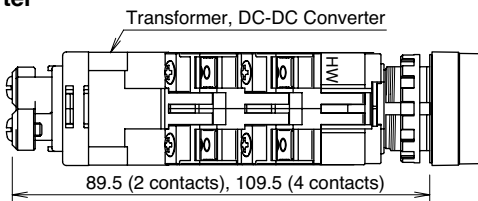

All dimensions in mm.

The above figures illustrate the spring-up screw types.

The depth of each finger-safe (IP20) contact block is 0.9 mm longer than that of a spring-up screw contact block.

*The depths of finger-safe (IP20) types are as follows:

Transformer Type (240V AC maximum): 89.5 (2 blocks)
109.5 (4 blocks)

Contact Arrangement Chart

Contact Arrangement			Contact Block		Top Button		Bottom Button		
Top Button	Bottom Button	Contact Code	Mounting Position	Type	Normal	Push	Normal	Push	
1NO	1NO	1010	1	NO		●			
			2	NO				●	
1NO	1NC	1001	1	NO		●			
			2	NC			●		
1NC	1NO	0110	1	NC	●				
			2	NO				●	
1NC	1NC	0101	1	NC	●				
			2	NC			●		
1NO	2NO	1020	1	NO		●			
			2	NO				●	
			3	Dummy					
			4	NO					●
1NO	1NO-1NC	1011	1	NO		●			
			2	NO				●	
			3	Dummy					
			4	NC				●	
1NO	2NC	1002	1	NO		●			
			2	NC			●		
			3	Dummy					
			4	NC				●	
1NC	2NO	0120	1	NC	●				
			2	NO				●	
			3	Dummy					
			4	NO					●
1NC	1NO-1NC	0111	1	NC	●				
			2	NO				●	
			3	Dummy					
			4	NC				●	
1NC	2NC	0102	1	NC	●				
			2	NC			●		
			3	Dummy					
			4	NC				●	
2NO	1NO	2010	1	NO		●			
			2	NO				●	
			3	NO		●			
			4	Dummy					
2NO	1NC	2001	1	NO		●			
			2	NC			●		
			3	NO		●			
			4	Dummy					
1NO-1NC	1NO	1110	1	NO		●			
			2	NO				●	
			3	NC	●				
			4	Dummy					
1NO-1NC	1NC	1101	1	NO		●			
			2	NC			●		
			3	NC	●				
			4	Dummy					

- Transformer and DC-DC converter types can have two or four contact blocks only.
- Contact blocks 1 and 3 are actuated by the top button. Contact blocks 2 and 4 are actuated by the bottom button.

Contact Block Mounting Position and Contact Arrangement Chart

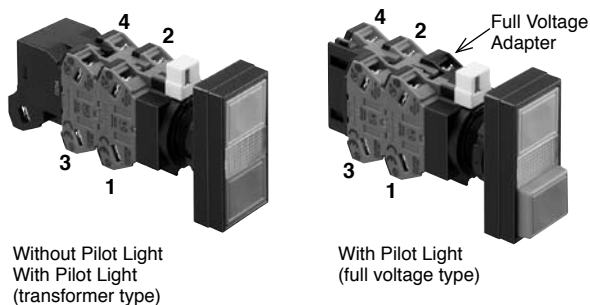

Contact Block		Top Button		Bottom Button	
		Normal	Push	Normal	Push
1	NO		●		
2	NO				●
3	NC	●			
4	NC			●	



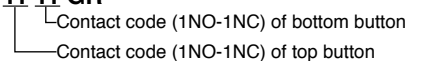





• Type No. Development
HW7D - B 12 11 11 GR



Contact Arrangement Chart



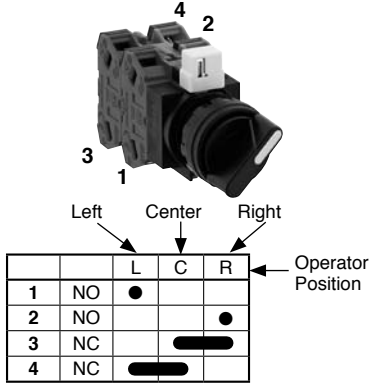





Contact Arrangement			Contact Block		Top Button		Bottom Button	
Top Button	Bottom Button	Contact Code	Mounting Position	Type	Normal	Push	Normal	Push
2NC	1NO	0210	1	NC	●			
			2	NO				●
			3	NC	●			
			4	Dummy				
2NC	1NC	0201	1	NC	●		●	
			2	NC			●	
			3	NC	●			
			4	Dummy				
2NO	2NO	2020	1	NO		●		
			2	NO				●
			3	NO		●		
			4	NO				●
2NO	1NO-1NC	2011	1	NO		●		
			2	NO				●
			3	NO		●		
			4	NC			●	
2NO	2NC	2002	1	NO		●		
			2	NC			●	
			3	NO		●		
			4	NC			●	
1NO-1NC	2NO	1120	1	NO		●		
			2	NO				●
			3	NC	●			
			4	NO				●
1NO-1NC	1NO-1NC	1111	1	NO		●		
			2	NO				●
			3	NC	●			
			4	NC			●	
1NO-1NC	2NC	1102	1	NO		●		
			2	NC			●	
			3	NC	●			
			4	NC			●	
2NC	2NO	0220	1	NC	●			
			2	NO				●
			3	NC	●			
			4	NO				●
2NC	1NO-1NC	0211	1	NC	●			
			2	NO				●
			3	NC	●			
			4	NC			●	
2NC	2NC	0202	1	NC	●			
			2	NC			●	
			3	NC	●			
			4	NC			●	

Selector Switches

No. of Positions	Shape			HW1S							
	Contact Arrangement Chart			 Dimensions on page 39.							
90° 2-position / 60° 2-position	Contact Code	Contact Block		Operator Position		Maintained (90°)	Spring Return from Right (60°)	—	—		
		Mounting Position	Type	L	R			—	—		
	10 (1NO)	1	NO		●		HW1S-2T@10	HW1S-21T@10	—	—	
		2	Dummy								
	11 (1NO-1NC)	1	NO		●		HW1S-2T@11	HW1S-21T@11			
		2	NC	●							
	20 (2NO)	1	NO		●		HW1S-2T@20	HW1S-21T@20			
		2	NO		●						
22 (2NO-2NC)	1	NO		●		HW1S-2T@22	HW1S-21T@22				
	2	NC	●								
	3	NO		●							
	4	NC	●								
45° 3-position	Contact Code	Contact Block		Operator Position			Maintained	Spring Return from Right	Spring Return from Left	Spring Return Two-way	
		Mounting Position	Type	L	C	R					
	20 (2NO)	1	NO	●			HW1S-3T@20	HW1S-31T@20	HW1S-32T@20	HW1S-33T@20	
		2	NO			●					
	02 (2NC)	1	NC		■		HW1S-3T@02	HW1S-31T@02	HW1S-32T@02	HW1S-33T@02	
		2	NC		■						
	22N1 (2NO-2NC)	1	NO	●			HW1S-3T@22N1	HW1S-31T@22N1	HW1S-32T@22N1	HW1S-33T@22N1	
		2	NO			●					
		3	NC		■						
		4	NC		■						
	22N9 ★ (2NO-2NC)	1	NC		■		HW1S-3ST@22N9	—	—	—	
		2	NC	●							
		3	NO		■						
		4	NO		■	●					
	40 (4NO)	1	NO	●			HW1S-3T@40	HW1S-31T@40	HW1S-32T@40	HW1S-33T@40	
		2	NO			●					
		3	NO	●							
		4	NO			●					
	40N2 ★ (4NO)	1	NO	●			HW1S-3ST@40N2	—	—	—	
		2	NO			●					
3		NO	●								
4		NO			●						
04 (4NC)	1	NC		■		HW1S-3T@04	HW1S-31T@04	HW1S-32T@04	HW1S-33T@04		
	2	NC		■							
	3	NC		■							
	4	NC		■							
21N1 ★ (2NO-1NC)	1	NO	●			HW1S-3JT@21N1	—	—	—		
	2	NO			●						
	3	NC		■							
	4	Dummy									
30° 5-position / 45° 4-position	Contact Code	Contact Block		Operator Position					Maintained	Maintained	• Contact Block Mounting Position and Contact Arrangement Chart 
		Mounting Position	Type	1	2	3	4	5			
	13N6 ★ (1NO-3NC)	1	NC		■					HW1S-4T@13N6	—
		2	NC		■						
		3	NC		■						
		4	NO					●			
	22N3 ★ (2NO-2NC)	1	NO	●						HW1S-4T@22N3	—
		2	NC		■						
		3	NC		■						
		4	NO					●			
	12 ★ (1NO-2NC)	1	NO	●						HW1S-4T@12	—
		2	NC		■						
3		NC		■							
4		Dummy									
22N3 ★ (2NO-2NC)	1	NO	●						—	HW1S-5T@22N3	
	2	NC		■							
	3	NC		■							
	4	NO					●				

- Specify a terminal style code in place of ® in the Type No. F: Finger-safe (IP20), blank: Spring-up screw
- On the contact arrangement marked with ★ in the table above, the rated current (load switching current) is reduced to a half of the rated current of the contact block. The rated insulation voltage and the rated thermal current remain unchanged.
- Selector switches with one or three contact blocks contain a dummy block. Knob operator: White indicator on black body
- Other contact arrangements are also available. See pages 40 through 43.

Key Selector Switches

No. of Positions	Shape		HW1K		 Dimensions on page 39.					
	Contact Arrangement Chart									
90° 2-position / 60° 2-position	Contact Code	Contact Block		Operator Position		Maintained (90°)	Spring Return from Right (60°)	—	—	
		Mounting Position	Type	L	R					
	10 (1NO)	1	NO		●					
		2	Dummy							
	11 (1NO-1NC)	1	NO		●					
		2	NC	●						
	20 (2NO)	1	NO		●					
		2	NO		●					
	22 (2NO-2NC)	1	NO		●					
		2	NC	●						
3		NO		●						
4		NC	●							
45° 3-position	Contact Code	Contact Block		Operator Position			Maintained	Spring Return from Right	Spring Return from Left	Spring Return Two-way
		Mounting Position	Type	L	C	R				
	20 (2NO)	1	NO	●						
		2	NO			●				
	02 (2NC)	1	NC		■					
		2	NC		■					
	22N1 (2NO-2NC)	1	NO	●						
		2	NO			●				
		3	NC		■					
		4	NC		■					
	22N9 ★ (2NO-2NC)	1	NC			●				
		2	NC	●						
		3	NO		■					
		4	NO			●				
	40 (4NO)	1	NO	●						
		2	NO			●				
		3	NO	●						
		4	NO			●				
	40N2 ★ (4NO)	1	NO	●						
		2	NO			●				
3		NO	●							
4		NO			●					
04 (4NC)	1	NC		■						
	2	NC		■						
	3	NC		■						
	4	NC		■						
21N1 ★ (2NO-1NC)	1	NO	●							
	2	NO			●					
	3	NC		■						
	4	Dummy								

- Specify a terminal style code in place of © in the Type No. F: Finger-safe (IP20), blank: Spring-up screw
- On the spring-returned types, the key can be released only from the maintained position. On the maintained types, the key can be released from every position. Key retained positions are also available. See page 8.
- Each key selector switch is supplied with two identical keys. Three different keys are also available. See page 8.
- On the contact arrangement marked with ★ in the table above, the rated current (load switching current) is reduced to a half of the rated current of the contact block. The rated insulation voltage and the rated thermal current remain unchanged.
- Key selector switches with one or three contact blocks contain a dummy block.
- Cylinder cover: black, Cylinder: metal
- Other contact arrangements are also available. See pages 40 through 43.



• Contact Block Mounting Position and Contact Arrangement Chart



		Left	Center	Right	
		L	C	R	Operator Position
1	NO	●			
2	NO			●	
3	NC		■		
4	NC		■		

Illuminated Selector Switches

90° 2-position / 60° 2-position

Shape		HW1F							
								Dimensions on page 39.	
Contact Arrangement Chart		Contact Block		Operator Position		Lamp	Input Type	Maintained (90°)	Spring Return from Right (60°)
Contact Code	Mounting Position	Type	L	R					
			11 (1NO-1NC)	1	NO		●	Without Lamp	Full Voltage
2	NC	●			LED	Transformer	HW1F-2⑥11③2②	HW1F-21⑥11③2②	
						DC-DC Converter	HW1F-211D2②	HW1F-2111D2②	
					Incandescent	Transformer	HW1F-2⑥11③5②	HW1F-21⑥11③5②	
20 (2NO)	1	NO		●	Without Lamp	Full Voltage	HW1F-2⑥20Q0②	HW1F-21⑥20Q0②	
	2	NO		●	LED	Transformer	HW1F-2⑥20③2②	HW1F-21⑥20③2②	
						DC-DC Converter	HW1F-220D2②	HW1F-2120D2②	
					Incandescent	Transformer	HW1F-2⑥20③5②	HW1F-21⑥20③5②	
22 (2NO-2NC)	1	NO		●	Without Lamp	Full Voltage	HW1F-2⑥22Q0②	HW1F-21⑥22Q0②	
	2	NC	●						
	3	NO		●	LED	Transformer	HW1F-2⑥22③2②	HW1F-21⑥22③2②	
						DC-DC Converter	HW1F-222D2②	HW1F-2122D2②	
4	NC	●		Incandescent	Transformer	HW1F-2⑥22③5②	HW1F-21⑥22③5②		

• Designation Codes

LED Illuminated Type	Incandescent Illuminated Type	③ Operating Voltage Code	⑥ Terminal Style Code
② Lens/LED Color Code	② Lens Color Code		
Specify a lens/LED color code in place of ② in the Type No. A: amber G: green R: red S: blue W: white Y: yellow Use a pure white LED lamp for yellow illumination.	Specify a lens color code in place of ② in the Type No. A: amber G: green R: red S: blue W: white	Specify an operating voltage code in place of ③ in the Type No. H: 100/110V AC H2: 115/120V AC M: 200/220V AC M4: 230/240V AC S: 380V AC T: 400/440V AC T8: 480V AC	Specify a terminal style code in place of ⑥ in the Type No. F: Finger-safe (IP20) blank: Spring-up screw Only spring-up screw terminals are available on DC-DC converter types.

- Full voltage types do not contain a lamp. Order LED or incandescent lamps separately. For lamps, see page 51.
- LED illuminated transformer and DC-DC converter types contain an LED lamp (LSTD-6②, rated voltage 6V AC/DC).
- Incandescent illuminated transformer types contain an incandescent lamp (LS-6, rated voltage 6V AC/DC).

• Contact Block Mounting Position and Contact Arrangement Chart

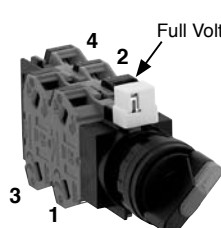

Full Voltage Type

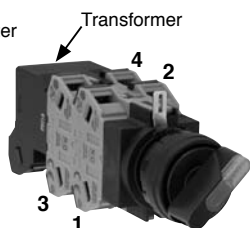

Transformer Type

		Left	Right	
		L	R	← Operator Position
1	NO	●		
2	NO		●	
3	NC			
4	NC			

For more contact arrangement chart, see pages 41 and 42.

ø22 HW Series Selector Switches

45° 3-position

Contact Code	Contact Block		Operator Position			Input Type	Maintained	Spring Return from Right	Spring Return from Left	Spring Return Two-way
	Mounting Position	Type	L	C	R					
20 (2NO)	1	NO	●			Without Lamp Full Voltage	HW1F-3⑥20Q0②	HW1F-31⑥20Q0②	HW1F-32⑥20Q0②	HW1F-33⑥20Q0②
	2	NO			●	LED Transformer	HW1F-3⑥20③2②	HW1F-31⑥20③2②	HW1F-32⑥20③2②	HW1F-33⑥20③2②
						DC-DC Converter	HW1F-320D2②	HW1F-3120D2②	HW1F-3220D2②	HW1F-3320D2②
							Incandescent Transformer	HW1F-3⑥20③5②	HW1F-31⑥20③5②	HW1F-32⑥20③5②
02 (2NC)	1	NC		■		Without Lamp Full Voltage	HW1F-3⑥02Q0②	HW1F-31⑥02Q0②	HW1F-32⑥02Q0②	HW1F-33⑥02Q0②
	2	NC	■			LED Transformer	HW1F-3⑥02③2②	HW1F-31⑥02③2②	HW1F-32⑥02③2②	HW1F-33⑥02③2②
						DC-DC Converter	HW1F-302D2②	HW1F-3102D2②	HW1F-3202D2②	HW1F-3302D2②
							Incandescent Transformer	HW1F-3⑥02③5②	HW1F-31⑥02③5②	HW1F-32⑥02③5②
22N1 (2NO-2NC)	1	NO	●			Without Lamp Full Voltage	HW1F-3⑥22N1Q0②	HW1F-31⑥22N1Q0②	HW1F-32⑥22N1Q0②	HW1F-33⑥22N1Q0②
	2	NO			●	LED Transformer	HW1F-3⑥22N1③2②	HW1F-31⑥22N1③2②	HW1F-32⑥22N1③2②	HW1F-33⑥22N1③2②
	3	NC		■	DC-DC Converter		HW1F-322N1D2②	HW1F-3122N1D2②	HW1F-3222N1D2②	HW1F-3322N1D2②
	4	NC	■			Incandescent Transformer	HW1F-3⑥22N1③5②	HW1F-31⑥22N1③5②	HW1F-32⑥22N1③5②	HW1F-33⑥22N1③5②
40 (4NO)	1	NO	●			Without Lamp Full Voltage	HW1F-3⑥40Q0②	HW1F-31⑥40Q0②	HW1F-32⑥40Q0②	HW1F-33⑥40Q0②
	2	NO			●	LED Transformer	HW1F-3⑥40③2②	HW1F-31⑥40③2②	HW1F-32⑥40③2②	HW1F-33⑥40③2②
	3	NO	●		DC-DC Converter		HW1F-340D2②	HW1F-3140D2②	HW1F-3240D2②	HW1F-3340D2②
	4	NO			●	Incandescent Transformer	HW1F-3⑥40③5②	HW1F-31⑥40③5②	HW1F-32⑥40③5②	HW1F-33⑥40③5②
04 (4NC)	1	NC		■		Without Lamp Full Voltage	HW1F-3⑥04Q0②	HW1F-31⑥04Q0②	HW1F-32⑥04Q0②	HW1F-33⑥04Q0②
	2	NC	■			LED Transformer	HW1F-3⑥04③2②	HW1F-31⑥04③2②	HW1F-32⑥04③2②	HW1F-33⑥04③2②
	3	NC	■		DC-DC Converter		HW1F-304D2②	HW1F-3104D2②	HW1F-3204D2②	HW1F-3304D2②
	4	NC	■			Incandescent Transformer	HW1F-3⑥04③5②	HW1F-31⑥04③5②	HW1F-32⑥04③5②	HW1F-33⑥04③5②

• Designation Codes

LED Illuminated Type ② Lens/LED Color Code	Incandescent Illuminated Type ② Lens Color Code	③ Operating Voltage Code	⑥ Terminal Style Code
Specify a lens/LED color code in place of ② in the Type No. A: amber G: green R: red S: blue W: white Y: yellow Use a pure white LED lamp for yellow illumination.	Specify a lens color code in place of ② in the Type No. A: amber G: green R: red S: blue W: white	Specify an operating voltage code in place of ③ in the Type No. H: 100/110V AC H2: 115/120V AC M: 200/220V AC M4: 230/240V AC S: 380V AC T: 400/440V AC T8: 480V AC	Specify a contact block code in place of ⑥ in the Type No. F: Finger-safe (IP20) blank: Spring-up screw Only spring-up screw terminals are available on DC-DC converter types.

- Full voltage types do not contain a lamp. Order LED or incandescent lamps separately. For lamps, see page 51.
- LED illuminated transformer and DC-DC converter types contain an LED lamp (LSTD-6②, rated voltage 6V AC/DC).
- Incandescent illuminated transformer types contain an incandescent lamp (LS-6, rated voltage 6V AC/DC).

• Contact Block Mounting Position and Contact Arrangement Chart

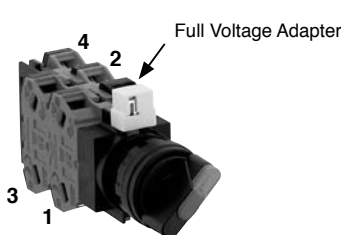

Full Voltage Type

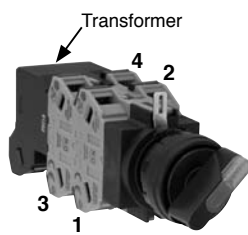

Transformer Type

		Left	Center	Right	Operator Position
		L	C	R	
1	NO	●			
2	NO			●	
3	NC		■		
4	NC		■		

For more contact arrangement chart, see pages 41 and 42.

Dimensions: Selector Switches

• Knob Operator

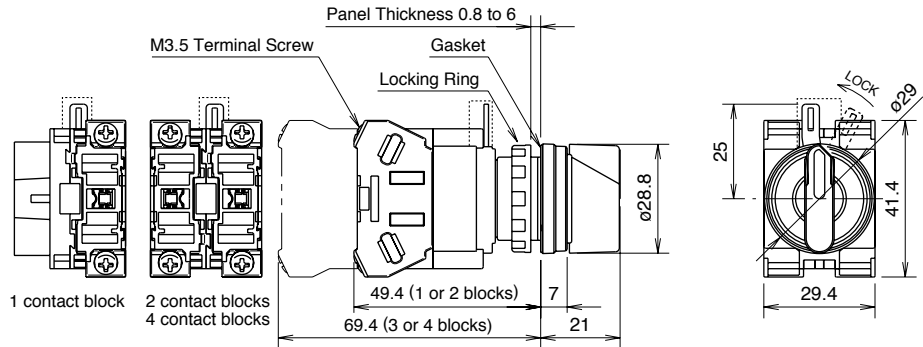

• Key Operator

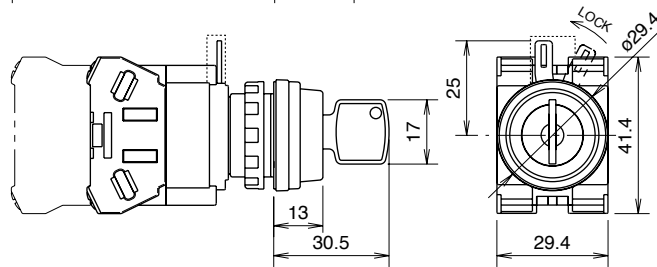

The above figures illustrates the spring-up screw types.

The depth of each finger-safe (IP20) contact block is 0.9 mm longer than that of a spring-up screw contact block.

All dimensions in mm.

Dimensions: Illuminated Selector Switches

• Full Voltage Type

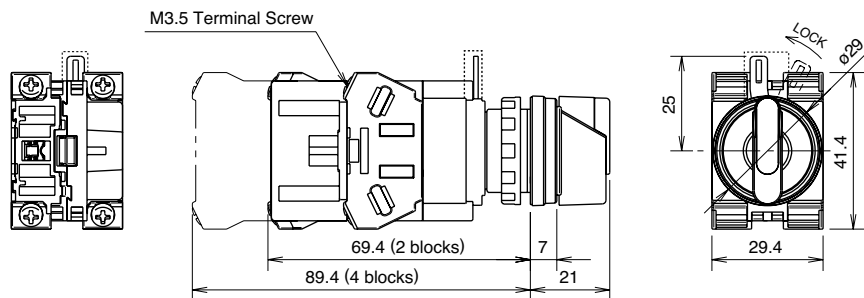

• Transformer Type (240V AC maximum)

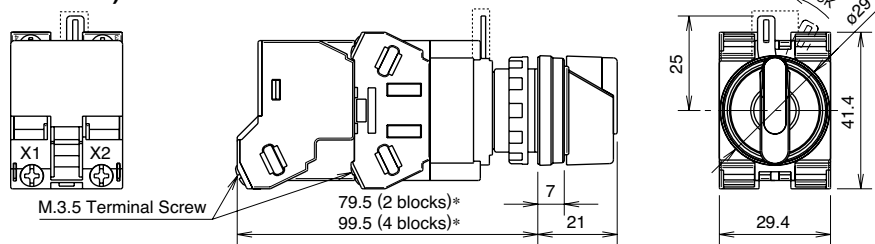

The above figures illustrate the spring-up screw types.

The depth of each finger-safe (IP20) contact block is 0.9 mm longer than that of a spring-up screw contact block.

*The depth of finger-safe (IP20) types are as follows:

Transformer Type: 89.5 (2 blocks)
109.5 (4 blocks)

All dimensions in mm.

For dimensions of transformer types (380V AC minimum) and DC-DC converter types, see page 29.

Terminal Wiring

Arrows indicate access directions for wiring.

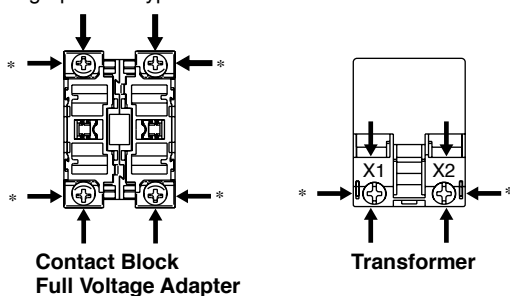

Spring-up screw type



*Spring-up screw type only.

ø22 HW Series Selector Switch Contact Arrangement Charts

90° 2-position (Maintained) / 60° 2-position (Spring Return)

Contact Code	Contact Block		Operator Position		Operator Availability						Cam Code	Remarks
					L			R				
	Mounting Position	Type	L	R	Knob	Key	Illuminated	Knob	Key	Illuminated		
10 (1NO)	1	NO		●	x	x	x	x	x	x	—	Standard
	2	Dummy										
01 (1NC)	1	NC	●		x	x	x	x	—	x	—	
	2	Dummy										
11 (1NO-1NC)	1	NO		●	x	x	x	x	x	x	—	Standard
	2	NC	●									
11N1 (2NO-2NC)	1	NC	●		x	x	x	x	—	x	—	
	2	NO		●								
20 (2NO)	1	NO		●	x	x	x	x	x	x	—	Standard
	2	NO		●								
02 (2NC)	1	NC	●		x	x	x	x	—	x	—	
	2	NC	●									
22 (2NO-2NC)	1	NO		●								Standard
	2	NC	●		x	x	x	x	—	x	—	
	3	NO		●								
	4	NC	●									
22N2 (2NO-2NC)	1	NC	●									
	2	NO		●	x	x	x	x	—	x	—	
	3	NC	●									
	4	NO		●								
22N1 (2NO-2NC)	1	NO		●								
	2	NO		●	x	x	x	x	—	x	—	
	3	NC	●									
	4	NC	●									
22N4 (2NO-2NC)	1	NC	●									
	2	NO		●	x	x	x	x	—	x	—	
	3	NO		●								
	4	NC	●									
31N1 (3NO-1NC)	1	NC	●									
	2	NO		●	x	x	x	x	—	x	—	
	3	NO		●								
	4	NO		●								
40 (4NO)	1	NO		●								
	2	NO		●	x	x	x	x	—	x	—	
	3	NO		●								
	4	NO		●								
7S ★ (1NO-1NC)	1	NO		■	x	x	x	x	—	x	—	
	2	NC	■									
8S ★ (2NO-2NC)	1	NO		■								
	2	NC	■		x	x	x	x	—	x	—	
	3	NO		■								
	4	NC	■									
22N7 ★ (2NO-2NC)	1	NC	■									
	2	NO		■	x	x	x	x	—	x	—	
	3	NC	■									
	4	NO		■								

• On the contact arrangement marked with ★ in the table above, the rated current (load switching current) is reduced to a half of the rated current of the contact block. The rated insulation voltage and the rated thermal current remain unchanged.

Remarks: When ordering the contact arrangement indicated with "Standard" in the table above, specify the Type No. shown in the standard Type No. on preceding pages. For other contact arrangements, see page 43 to specify the Type No. and contact code.

45° 3-position

Contact Code	Contact Block		Operator Position			Operator Availability												Cam Code	Remarks
	Mounting Position	Type	L	C	R	Knob	Key	Illuminated	Knob	Key	Illuminated	Knob	Key	Illuminated	Knob	Key	Illuminated		
11 (1NO-1NC)	1	NO	●			x	x	x	x	x	x	x	x	x	x	x	x	—	
	2	NC	■																
11N1 (1NO-1NC)	1	NC		■		x	x	x	x	x	x	x	x	x	x	x	x	—	
	2	NO			●														
7S ★ (1NO-1NC)	1	$\overline{\text{NO}}$	●		●	x	x	x	—	—	—	—	—	—	—	—	—	J	
	2	$\overline{\text{NC}}$	■																
11N1 ★ (1NO-1NC)	1	NC		●		x	x	x	—	—	—	—	—	—	—	—	—	J	
	2	NO			●														
20 (2NO)	1	NO	●			x	x	x	x	x	x	x	x	x	x	x	x	—	
	2	NO			●													Standard	
1S ★ (2NO)	1	NO	●		●	x	x	x	—	—	—	—	—	—	—	—	—	J	
	2	NO			●														
2S ★ (2NC)	1	NC		●		x	x	x	—	—	—	—	—	—	—	—	—	J	
	2	$\overline{\text{NO}}$	■																
02 (2NC)	3	NC		■		x	x	x	x	x	x	x	x	x	x	x	x	—	
	4	NC	■															Standard	
22N1 (2NO-2NC)	1	NO	●																
	2	NO			●	x	x	x	x	x	x	x	x	x	x	x	x	—	
	3	NC		■														Standard	
	4	NC	■																
22N2 (2NO-2NC)	1	NC		■		x	x	x	x	x	x	x	x	x	x	x	x	—	
	2	NO			●														
	3	NC		■															
	4	NO			●														
8S ★ (2NO-2NC)	1	$\overline{\text{NO}}$	●		●	x	x	x	—	—	—	—	—	—	—	—	—	J	
	2	$\overline{\text{NC}}$	■																
	3	$\overline{\text{NO}}$	●		●														
	4	$\overline{\text{NC}}$	■																
22N8 ★ (2NO-2NC)	1	$\overline{\text{NO}}$	●		●	x	x	x	—	—	—	—	—	—	—	—	—	J	
	2	NC		■															
	3	NC		■															
	4	NO			●														
22N2 ★ (2NO-2NC)	1	NC		■		x	x	x	—	—	—	—	—	—	—	—	—	J	
	2	NO			●														
	3	NC		■															
	4	NO			●														
31 (3NO-1NC)	1	NO	●			x	x	x	x	x	x	x	x	x	x	x	x	—	
	2	NC		■															
	3	NO	●																
	4	NO			●														
31N1 (3NO-1NC)	1	NC		■		x	x	x	x	x	x	x	x	x	x	x	x	—	
	2	NO			●														
	3	NO	●																
	4	NO			●														
13 (1NO-3NC)	1	NO	●			x	x	x	x	x	x	x	x	x	x	x	x	—	
	2	NC		■															
	3	NC		■															
	4	NC		■															
13N3 ★ (1NO-3NC)	1	NC		■		x	x	x	—	—	—	—	—	—	—	—	—	J	
	2	NO			●														
	3	NC		■															
	4	NC		■															

Remarks: When ordering the contact arrangement indicated with "Standard" in the table above, specify the Type No. shown in the standard Type No. on preceding pages. For other contact arrangements, see page 43 to specify the Type No. and contact code.

Ø22 HW Series Selector Switch Contact Arrangement Charts

45° 3-position

Contact Code	Contact Block		Operator Position			Operator Availability												Cam Code	Remarks
	Mounting Position	Type	L	C	R	Knob	Key	Illuminated	Knob	Key	Illuminated	Knob	Key	Illuminated	Knob	Key	Illuminated		
40 (4NO)	1	NO	●																
	2	NO			●	x	x	x	x	x	x	x	x	x	x	x	x	x	
	3	NO	●																
	4	NO			●														
40N1 ★ (4NO)	1	NO	●		●														
	2	NO			●	x	x	x	-	-	-	-	-	-	-	-	-	-	
	3	NO	●		●														
	4	NO			●														
04 (4NC)	1	NC		■															
	2	NC	■			x	x	x	x	x	x	x	x	x	x	x	x	x	
	3	NC		■															
	4	NC	■																
04N2 ★ (4NC)	1	NC		●															
	2	NC	■			x	x	x	-	-	-	-	-	-	-	-	-	-	
	3	NC		●															
	4	NC	■																
22 ★ (2NO-2NC)	1	NO	●																
	2	NC		●		x	x	x	-	-	-	-	-	-	-	-	-	-	
	3	NO	●																
	4	NC		●															
21N1 ★ (2NO-1NC)	1	NO	●																
	2	NO			●	x	x	x	-	-	-	-	-	-	-	-	-	-	
	3	NC		●															
	4	Dummy																	
40N2 ★ (4NO)	1	NO	●		■														
	2	NO			■	x	x	x	-	-	-	-	-	-	-	-	-	-	
	3	NO	●																
	4	NO			●														
22N9 ★ (2NO-2NC)	1	NC			■														
	2	NC	●			x	x	x	-	-	-	-	-	-	-	-	-	-	
	3	NO	■																
	4	NO			●														
31N4 ★ (3NO-1NC)	1	NO	●																
	2	NC	■			x	x	x	-	-	-	-	-	-	-	-	-	-	
	3	NO	●		●														
	4	NO			●														
13N1 ★ (1NO-3NC)	1	NO	●																
	2	NC	■			x	x	x	-	-	-	-	-	-	-	-	-	-	
	3	NC		●															
	4	NC	■																
22N5 ★ (2NO-2NC)	1	NC			■														
	2	NO			●	x	x	x	-	-	-	-	-	-	-	-	-	-	
	3	NC		●															
	4	NO			●														
31N2 ★ (3NO-1NC)	1	NO	●																
	2	NO			●	x	x	x	-	-	-	-	-	-	-	-	-	-	
	3	NC		●															
	4	NO			●														
13N2 ★ (1NO-3NC)	1	NC			■														
	2	NC	■			x	x	x	-	-	-	-	-	-	-	-	-	-	
	3	NC		●															
	4	NO			●														

Remarks: When ordering the contact arrangement indicated with "Standard" in the table above, specify the Type No. shown in the standard Type No. on preceding pages. For other contact arrangements, see page 43 to specify the Type No. and contact code.

45° 4-position

Contact Code	Contact Block		Operator Position				Operator Availability	Cam Code	Remarks
	Mounting Position	Type	1	2	3	4	Knob		
12 ★ (1NO-2NC)	1	NO	●				x	-	Standard
	2	NC		●					
	3	NC			●				
	4	Dummy							
04N3 ★ (4NC)	1	NC		██████████			x	-	
	2	NC		●					
	3	NC			●				
	4	NC	██████████						
13N6 ★ (1NO-3NC)	1	NC		██████████			x	-	Standard
	2	NC		●					
	3	NC			●				
	4	NO				●			
13N5 ★ (1NO-3NC)	1	NO	●				x	-	
	2	NC		●					
	3	NC			●				
	4	NC	██████████						
22N3 ★ (2NO-2NC)	1	NO	●				x	-	Standard
	2	NC		●					
	3	NC			●				
	4	NO				●			

30° 5-position

Contact Code	Contact Block		Operator Position					Operator Availability	Cam Code	Remarks
	Mounting Position	Type	1	2	3	4	5	Knob		
22N3 ★ (2NO-2NC)	1	NO	●					x	-	Standard
	2	NC		●						
	3	NC				●				
	4	NO					●			

• Contact Block Mounting Position and Contact Arrangement Chart



Non-illuminated Selector
Illuminated Selector
(Transformer Type)

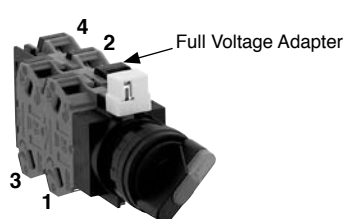

Illuminated Selector
(Full Voltage Type)

		Left	Center	Right	
		L	C	R	Operator Position
1	NO	●			
2	NO			●	
3	NC		██████████		
4	NC	██████████			

Type No. Development

• When cam code is not required

HW1S - 2 T F 11



- Contact code (1NO-1NC)
- "T" for knob operator
- 2-position

• When cam code is required

HW1K - 3 J A F 22N2

- Contact code (2NO-2NC)
- Key removal option code
- Cam code (J, S, or none)
- 3-position

Pushbutton Selectors

Shape	Circuit Category	Contact Code	Contact Block		Normal		Depressed		Type No.	① Button Color Code
			Mounting Position	Type	Normal	Depressed	Normal	Depressed		
 	A	11 (1NO-1NC)	1	NO		●		●	HW1R-2A⑥11①	Specify a button color code in place of ① in the Type No. B: black G: green R: red S: blue W: white Y: yellow
			2	NC	●					
		20 (2NO)	1	NO		●		●	HW1R-2A⑥20①	
			2	NO		●	■			
		22 (2NO-2NC)	1	NO		●		●	HW1R-2A⑥22①	
			2	NC	●					
	3		NO		●		●			
	4		NC	●						
	D	20 (2NO)	1	NO		●		●	HW1R-2D⑥20①	
			2	NO		●		●		
		22N1 (2NO-2NC)	1	NO		●		●	HW1R-2D⑥22N1①	
			2	NO		●		●		
	E	22N1 ★ (2NO-2NC)	3	NC	●		■		HW1R-2E⑥22N1①	
			4	NC	●					
			1	NO		●		●		
			2	NO		●		●		
	F	22N1 ★ (2NO-2NC)	3	NC			■		HW1R-2F⑥22N1①	
			4	NC	●					
			1	NO		●		●		
			2	NO		●		●		
	N	22N2 ★ (2NO-2NC)	3	NC			■		HW1R-2N⑥22N2①	
			4	NO		●		●		
			1	NO		●		●		
			2	NO		●		●		
T	22N1 ★ (2NO-2NC)	3	NC	●		■		HW1R-2T⑥22N1①		
		4	NC	●						
		1	NO		●	●	Blocked			
		2	NO		●	●				

- On the contact arrangement marked with ★ in the table above, the rated current (load switching current) is reduced to a half of the rated current of the contact block. The rated insulation voltage and the rated thermal current remain unchanged.
- Specify a terminal style code in place of ⑥ in the Type No. F: Finger-safe (IP20), blank: Spring-up screw
- When operating the pushbutton selector, do not turn the operator ring or the lock lever while the button is depressed. Otherwise the pushbutton selector may be damaged.
- Other contact arrangements are also available upon request.

Dimensions

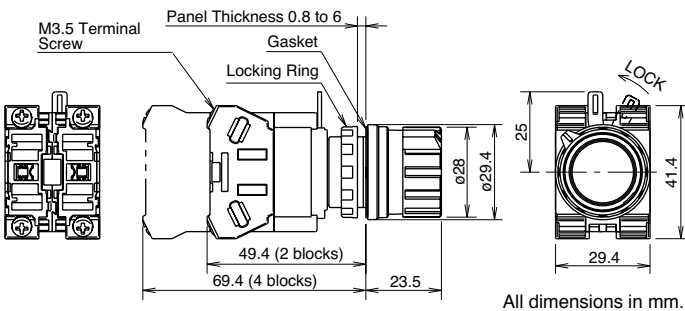

The above figure illustrates the spring-up screw type.
 The depth of each finger-safe (IP20) contact block is 0.9 mm longer than that of a spring-up screw contact block.

• Contact Block Mounting Position and Contact Arrangement Chart

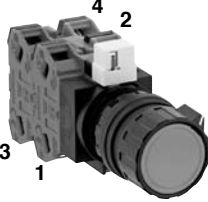

Contact Block	Left		Right	
	Normal	Depressed	Normal	Depressed
1	NO			●
2	NO	●		
3	NC		●	
4	NC	●		

← Ring Position
← Button

Mono-Lever Switches

Shape	Positions	Type No.
HW1M Standard Lever 	2-position	HW1M-1010-Ⓞ20
		HW1M-2020-Ⓞ20
		HW1M-0101-Ⓞ20
		HW1M-0202-Ⓞ20
		HW1M-0101-Ⓞ40
	HW1M-L Interlocking Lever 	2-position
HW1M-2222-Ⓞ22N9		
HW1M-L1010-Ⓞ20		
HW1M-L2020-Ⓞ20		
HW1M-L0101-Ⓞ20		
		4-position
	HW1M-L0101-Ⓞ40	
	HW1M-L0202-Ⓞ40	
	HW1M-L1111-Ⓞ22N9	
	HW1M-L2222-Ⓞ22N9	

- On all mono-lever switches, the rated current (load switching current) is reduced to a half of the rated current of the contact block. The rated insulation voltage and the rated thermal current remain unchanged.
- Specify a terminal style code in place of Ⓞ in the Type No. F: Finger-safe (IP20), blank: Spring-up screw

• Contact Arrangement Chart

• 2-position (Right/Left)

Contact Code	Contact Block		Lever Operator Position		
	Mounting Position	Type	Left	Center	Right
20	1	NO	●		
	2	NO			●
40	1	NO	●		
	2	NO			●
	3	NO	●		
	4	NO			●

• 2-position (Up/Down)

Contact Code	Contact Block		Lever Operator Position		
	Mounting Position	Type	Down	Center	Up
20	1	NO	●		
	2	NO			●
40	1	NO	●		
	2	NO			●
	3	NO	●		
	4	NO			●

• 4-position

Contact Code	Contact Block		Lever Operator Position				
	Mounting Position	Type	Down	Left	Center	Up	Right
22N9	1	NC	●				
	2	NC					●
	3	NO	●				
	4	NO					●

Ordering Information

HW1M-L

Up R Dn L
1 1 1 1

F

22N9

Type

HW1M: Standard
HW1M-L: Interlocking

Lever Operation Mode

Order of Entry
Up → Right → Down → Left
1: Maintained
2: Spring returned
0: Blocked

Terminal Style Code

F: Finger-safe (IP20)
blank: Spring-up screw

Contact Code

Select a required contact operation at each lever operator position from the contact arrangement charts above and specify the Contact Code.

Dimensions

• Contact Block Mounting Position and Lever Operator Position

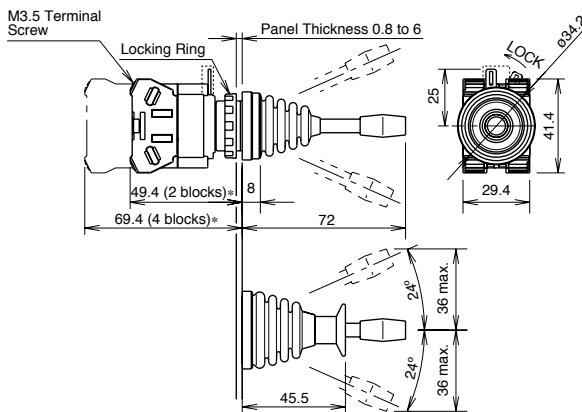
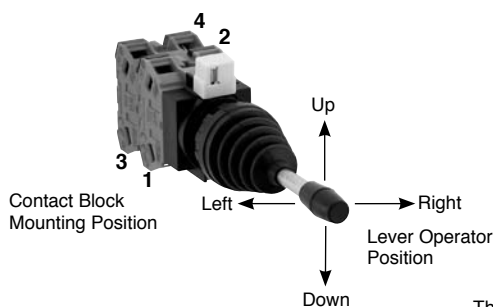

All dimensions in mm.

The above figure illustrates the spring-up screw type.

The depth of each finger-safe (IP20) contact block is 0.9 mm longer than that of a spring-up screw contact block.

Accessories

Nameplates

•HWAM, HWAQ, HWAS, and HWAV

Description	Legend	Material	Type No.	Ordering Type No.	Package Quantity	Dimensions (mm)
HWAM	Order marking plate separately.	Plastic (black) 1.5 mm thick	HWAM	HWAM	1	
				HWAMPN10	10	
HWAQ	Order marking plate separately.	Plastic (black) 1.5 mm thick	HWAQ	HWAQ	1	
				HWAQPN10	10	
HWAS	Blank	Plastic (black) 1.5 mm thick	HWAS-0	HWAS-0	1	
				HWAS-0PN10	10	
HWAV	Blank	Plastic (yellow) 1.5 mm thick	HWAV-0-Y	HWAV-0-Y	1	
	EMERGENCY STOP		HWAV-27-Y	HWAV-27-Y	1	

•Making Plate

Description	Material	Type No.	Ordering Type No.	Package Quantity	Dimensions (mm)
HWNP	Aluminum (black) 1.0 mm thick	HWNP-*	HWNP*	1	White legend on black background.
			HWNP-*PN10	10	

• Specify a legend code in place of * in the Ordering Type No.

•Legends

Code	Legend
0	(blank)
1	ON
2	OFF
3	START
4	STOP
31	OFF-ON
33	HAND-AUTO
53	HAND-OFF-AUTO

• Installing the marking plate on a nameplate

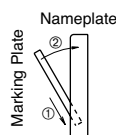



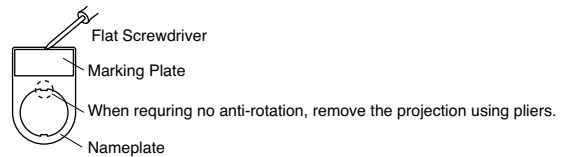





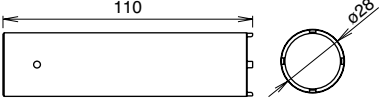

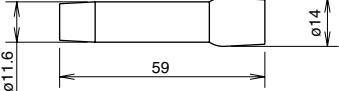

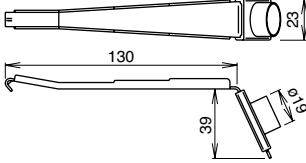
• To remove the marking plate, insert the flat screwdriver between the marking plate and nameplate.

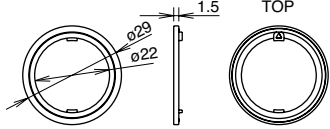

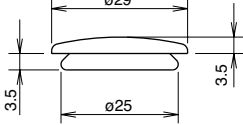

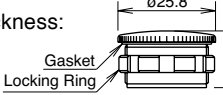

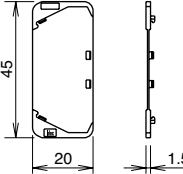

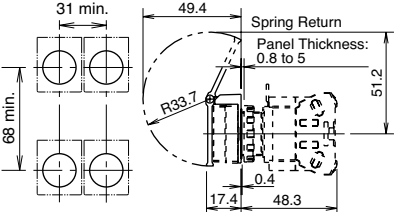

Note: When using an nameplate, the mounting panel thickness is decreased by 1.5 mm.

Accessories

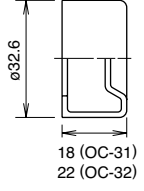

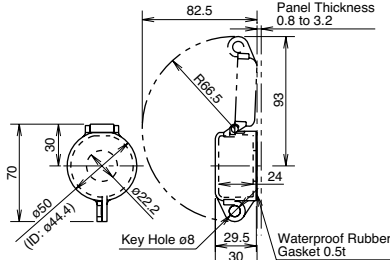
Shape	Material	Type No.	Ordering Type No.	Package Quantity	Dimensions (mm)
	Metal (weight: approx. 150g)	MW9Z-T1	MW9Z-T1	1	<ul style="list-style-type: none"> Used to tighten the locking ring when installing the HW switch onto a panel. Tighten the locking ring to a torque of 2.0 N·m. 
	Rubber	OR-55	OR-55	1	<ul style="list-style-type: none"> Used to install and remove the LED/incandescent lamps. 
	Metal/ Rubber	TW-KC1	TW-KC1	1	<ul style="list-style-type: none"> Used to remove the contact block and transformer, and also to install/remove the pilot light and illuminated pushbutton lens. 
	Plastic	HW9Z-RL	HW9Z-RLPN10	10	<ul style="list-style-type: none"> Used to prevent the operator from turning. Generally used when using no nameplates on selector switches and pushbutton selectors. 
	Rubber (black)	OB-31	OB-31PN05	5	<ul style="list-style-type: none"> Used to plug the unused ø22.2mm mounting holes. 
	Diecast Metal (locking ring: plastic)	LW9Z-BM	LW9Z-BM	1	<ul style="list-style-type: none"> Used to plug the unused ø22.2mm mounting holes. Tighten the locking ring to a torque of 1.2 N·m. IP66 Mounting panel thickness: 0.8 to 6 mm 
	Plastic (nylon)	LW9Z-BP1	LW9Z-BP1	1	<ul style="list-style-type: none"> Used to plug the unused ø22.2mm mounting holes. Tighten the locking ring to a torque of 2.0 N·m. IP65 Mounting panel thickness: 0.8 to 6 mm
	Plastic	HW-VG1	HW-VG1PN10	10	<ul style="list-style-type: none"> Used to prevent contact between adjacent lead wires when units are mounted closely. Barriers should always be used in close mounting. 

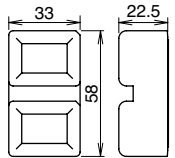
ø22 HW Series Accessories and Replacement Parts

Accessories





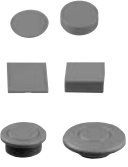







Shape		Material	Type No.	Ordering Type No.	Package Quantity	Dimensions (mm)
	Spring Return	Plastic	HW9Z-K1	HW9Z-K1	1	<ul style="list-style-type: none"> Used to prevent inadvertent operation for flush pushbuttons and illuminated pushbuttons. IP65 Maintained type stops at 90° and 180°. 
	Maintained		HW9Z-K11	HW9Z-K11	1	
	For flush pushbuttons	Rubber (EPDM)	OC-31	OC-31	1	<ul style="list-style-type: none"> Used to cover and protect pushbuttons where units are subject to watersplash. Not suitable for outdoor use or where the units are subject to oil splash. 
	For extended pushbuttons		OC-32	OC-32	1	
		Polyarylate (gasket: nitril rubber)	HW9Z-KL1	HW9Z-KL1	1	<ul style="list-style-type: none"> Used to protect pushbuttons, illuminated pushbuttons, selector switches, and key selector switches. 
		Clear Silicon Rubber	HW9Z-D7D	HW9Z-D7D	1	<ul style="list-style-type: none"> Degree of protection: IP65 
		Rubber	HW9Z-A25	HW9Z-A25PN05	5	<ul style="list-style-type: none"> Used to install the HW/TW units into ø25 mm mounting holes. IP65 Cannot be used with anti-rotation ring and nameplate. Mounting panel thickness: 1.2 to 6.0 mm
		Gasket: Nylon Washer: Metal (brass)	HW9Z-A30	HW9Z-A30PN02	2	<ul style="list-style-type: none"> Used to install the HW units into ø30 mm mounting holes (except for HW1E, HW1B-M5/V5, and HW7D). IP65 Cannot be used with anti-rotation ring, nameplate, full-shroud illuminated pushbuttons, pushbutton selectors, and mono-lever switches. Mounting panel thickness: 1.6 to 4.0 mm

Maintenance Parts

Shape	Specification	Type No.	Ordering Type No.	Package Quantity	Remarks	
	NO contact	HW-G10	HW-G10	1		
	1NC contact	HW-G01	HW-G01	1		
	EM (early make) contact	HW-G10R	HW-G10R	1		
	LB (late break) contact	HW-G01R	HW-G01R	1		
	1NO contact	HW-F10	HW-F10	1		
	1NC contact	HW-F01	HW-F01	1		
	EM (early make) contact	HW-F10R	HW-F10R	1		
	LB (late break) contact	HW-F01R	HW-F01R	1		
	Nylon	TW-DB	TW-DBPN10	10		
 (Photo: Spring-up screw)	Spring-up screw	HW-GA1	HW-GA1PN02	2		
	Finger-safe (IP20)	HW-DA1FB	HW-DA1FB	1		
 (Photo: Spring-up screw)	100/110V AC	Spring-up screw	HW-T16	HW-T16	1	<ul style="list-style-type: none"> • For illuminated pushbuttons and illuminated selector switches.
		Finger-safe (IP20)	TW-F16B	TW-F16B	1	
	115/120V AC	Spring-up screw	HW-T126	HW-T126	1	
		Finger-safe (IP20)	TW-F126B	TW-F126B	1	
	200/220V AC	Spring-up screw	HW-T26	HW-T26	1	
		Finger-safe (IP20)	TW-F26B	TW-F26B	1	
	230/240V AC	Spring-up screw	HW-T246	HW-T246	1	
		Finger-safe (IP20)	TW-F246B	TW-F246B	1	
	380V AC	Spring-up screw	—	—	—	
		Finger-safe (IP20)	TW-F386B	TW-F386B	1	
400/440V AC	Spring-up screw	HW-L46	HW-L46	1		
	Finger-safe (IP20)	TW-F46B	TW-F46B	1		
480V AC	Spring-up screw	HW-L486	HW-L486	1		
	Finger-safe (IP20)	TW-F486B	TW-F486B	1		
	110V DC	Spring-up screw	HW-L16D	HW-L16D	1	
	AS resin	HW1A-P2②	HW1A-P2②PN05	5	<ul style="list-style-type: none"> • Specify a color code in place of ②. A (amber), G (green), R (red), S (blue), W (white), Y (yellow) 	
	Round flush with round or square bezel	Polyacetal	HW1A-B1①	HW1A-B1①PN05	5	<ul style="list-style-type: none"> • Specify a button color code in place of ①. B (black) G (green) R (red) S (blue) W (white) Y (yellow)
	Round extended with round or square bezel		HW1A-B2①	HW1A-B2①PN05	5	
	Square flush		HW2A-B1①	HW2A-B1①PN05	5	
	Square extended		HW2A-B2①	HW2A-B2①PN05	5	
	ø29mm mushroom		HW1A-B3①	HW1A-B3①PN02	2	
	ø40mm mushroom		HW1A-B4①	HW1A-B4①PN02	2	

ø22 HW Series Accessories and Replacement Parts



Maintenance Parts

Shape		Specification	Type No.	Ordering Type No.	Package Quantity	Color Code
Lens (for pilot lights and illuminated pushbuttons) 	Round flush	Polyarylate	HW9Z-L11②	HW9Z-L11②PN05	5	A (amber), C (clear), G (green), R (red), S (blue), Y (yellow) Use a clear lens for pure white and white illumination.
	Square flush		HW9Z-L21②	HW9Z-L21②PN05	5	
	Round extended		HW9Z-L12②	HW9Z-L12②PN05	5	
Lens (for illuminated pushbuttons) 	ø29mm mushroom	AS, Marking type	ALW31L-②	ALW31L-②PN02	2	C (clear), G (green), R (red), S (blue)
	ø40mm mushroom		ALW31LD-②	ALW31LD-②PN02	2	A (amber), Y (yellow)
			ALW41L-②	ALW41L-②	1	C (clear), G (green), R (red), S (blue)
			ALW41LD-②	ALW41LD-②	1	A (amber), Y (yellow)
Dome Lens for Pilot Light 		AS resin	HW1A-P2②	HW1A-P2②PN05	5	Specify a color code in place of ②. A (amber), G (green), R (red), S (blue), W (white), and Y (yellow)
Jumbo Dome Lens 		Polycarbonate	HW1A-P5②	HW1A-P5②	1	Specify a lens color code in place of ②. A: amber, G: green, R: red, S: blue, W: white, Y: yellow
Marking Plate 	Round flush	Acrylic	HW9Z-P11	HW9Z-P11PN05	5	• White
	Round extended		HW9Z-P12	HW9Z-P12PN05	5	
	Square flush		HW9Z-P21	HW9Z-P21PN05	5	
	ø29/40mm mushroom		ALW3B	ALW3BPN05	5	
Operator Knob for Illuminated Selector Switch 		Polyarylate	HW9Z-FDY②	HW9Z-FDY②	1	A (amber), G (green), R (red), S (blue), W (white), Y (yellow)
Replacement key 	Key selector switch	Metal	HW9Z-SK-231	HW9Z-SK-231PN02	2	
Locking Ring 		Plastic	HW9Z-LN	HW9Z-LNPN05	5	• Black
Cap for Mono-Lever Switch 	Standard	Rubber	HW9Z-CPM	HW9Z-CPM	1	
Boot for Mono-Lever Switch 			HW9Z-BLM	HW9Z-BLM	1	
Diffusing Lens 		Polycarbonate	HW9Z-PP5C	HW9Z-PP5C	1	Diffusing lens is used for LED type jumbo dome pilot lights only.
Safety Lever Lock 		Plastic	HW9Z-LS	HW9Z-LSPN10	10	• Yellow
Gasket 		Rubber	HW9Z-WM	HW9Z-WMP10	10	

Note: Specify a button color code or lens color code in place of ① or ② in the Ordering Type No.

Maintenance Parts



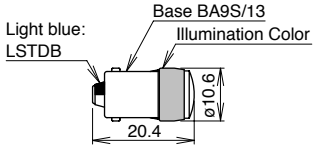

LED Lamps (LSTD) [except for HW Jumbo Dome pilot lights]

Operating Voltage	Current Draw		Type No.	Ordering Type No.	Illumination Color Code	Package Quantity	Base
	AC	DC					
6V AC/DC ±5% 	8 mA	7 mA (A, R, W), 5.5 mA (G, PW, S)	LSTD-6②	LSTD-6②	Specify a color code in place of ② in the Ordering Type No. A: amber G: green PW: pure white R: red S: blue W: white Use a pure white (PW) LED lamp with yellow (Y) lens.	1	BA9S/13
				LSTD-6②PN10		10	
12V AC/DC ±10% 	11 mA	10 mA	LSTD-1②	LSTD-1②		1	
				LSTD-1②PN10		10	
24V AC/DC ±10% 	11 mA	10 mA	LSTD-2②	LSTD-2②		1	
				LSTD-2②PN10		10	

LED Lamps (LSTDB) [used for HW Jumbo Dome pilot lights only]

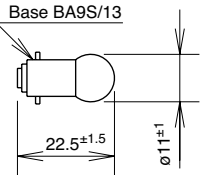
Operating Voltage	Current Draw		Type No. (Ordering Type No.)	Illumination Color Code	Package Quantity	Dimensions
	AC	DC				
24V AC/DC ±10% 	15 mA	15 mA	LSTDB-2②	Specify a color code in place of ② in the Ordering Type No. A: amber G: green PW: pure white R: red S: blue W: white Use a pure white (PW) LED lamp with yellow (Y) lens.	1	 <p>Light blue: LSTDB Base BA9S/13 Illumination Color 20.4 ø10.6</p>

Incandescent Lamps (LS) [except for HW Jumbo Dome pilot lights]

Rated Operating Voltage	Lamp Ratings	Type No. (Ordering Type No.)	Package Quantity	Dimensions
6V AC/DC 	1W (6.3V)	LS-6	1	 <p>Base BA9S/13 22.5±1.5 ø11±1</p>
12V AC/DC 	1W (18V)	LS-8		
18V AC/DC 	1W (24V)	LS-2		
24V AC/DC 	1W (30V)	LS-3		

Incandescent Lamps (LSB) [used for HW Jumbo Dome pilot lights only]

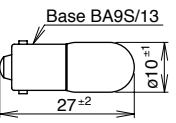
Rated Operating Voltage	Lamp Ratings	Type No.	Ordering Type No.	Package Quantity	Dimensions
24V AC/DC 	28V, 0.17A	LSB-2	LSB-2PN02	2	 <p>Base BA9S/13 27±2 ø10±0.1</p>

Separate Mounting Type Transformer

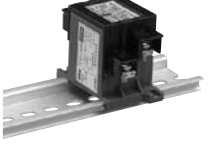
Shape	Primary Voltage	Secondary Voltage	Type No. (Ordering Type No.)	Applicable Load
	100/110V AC	5.5V AC, 1W	TWR516	LSTD-6 LED lamp (6V AC/DC) or LS-6 incandescent lamp (6V AC/DC, 1W)
	115/120V AC		TWR5126	
	200/220V AC		TWR526	
	230/240V AC		TWR5246	
	380V AC		TWR5386	
	400/440V AC		TWR546	
	480V AC		TWR5486	

Specifications

Operating Voltage	100/110V AC, 115/120V AC, 200/220V AC, 230/240V AC, 380V AC, 400/440V AC, 480V AC (50/60Hz)
Current Draw	2.4 VA
Rated Insulation Voltage	600V
Insulation Resistance	100 MΩ minimum (500V DC megger)
Operating Temperature	-30 to +60°C (no freezing)
Operating Humidity	35 to 85% RH (no condensation)
Vibration Resistance	Operating extremes: 5 to 55 Hz, amplitude 0.5 mm
Shock Resistance	Damage limits: 1,000 m/s ²
Dielectric Strength	2,500V AC, 1 minute
Terminal Screw	M3.5
Applicable Wire	2 mm ² maximum, 2 wires maximum

Dimensions

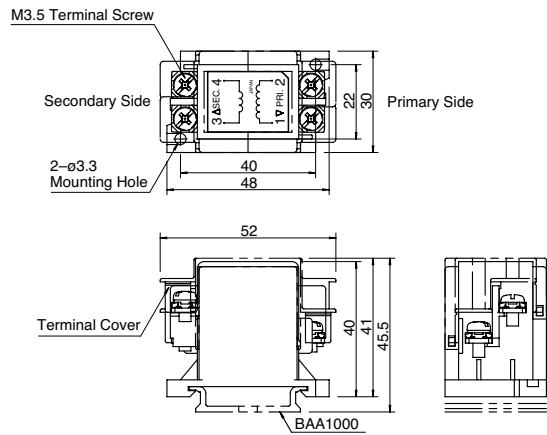

Accessories

• DIN Rail

Type No.	Ordering Type No.	Length	Weight (approx.)	Material	Package Quantity
BAA1000	BAA1000PN10	1000 mm	200g	Aluminum	10
BAP1000	BAP1000PN10	1000 mm	320g	Steel	10

• End Clip

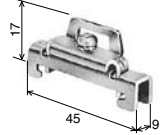
Type No.	Ordering Type No.	Applicable DIN Rail	Weight (approx.)	Material	Package Quantity	Dimensions
BNL6	BNL6PN10	BAA1000 BAP1000	15g	Steel (Zinc-plated)	10	

• Use plastic end clip BC9Z-E/NS35N when using 400/440V AC primary voltage transformers.

Safety Precautions

- Turn off the power to the HW series control units before installation, removal, wiring, maintenance, and inspection of the HW series control units. Failure to turn power off may cause electrical shocks or fire hazard.
- To avoid a burn on your hand, use the lamp holder tool when replacing lamps.
- For wiring, use wires of a proper size to meet the voltage and current requirements. Tighten the M3.5 terminal screws to a tightening torque of 1.0 to 1.3 N.m. Failure to tighten terminal screws may cause overheating and fire.

Instructions

Panel Mounting

Remove the contact block from the operator (for transformer type pilot lights, remove the transformer from the illumination unit). Remove the locking ring from the operator. Insert the operator into the panel cut-out from the front, tighten the locking ring from the back, then install the contact block to the operator.

• Removing and Installing the Contact Block

1. To remove the operator from the contact block, turn the locking lever in the direction of the arrow shown below. Then the operator can be pulled out.
2. To reinstall, place the TOP markings on the operator and the contact block mounting adapter in the same direction, and insert the operator into the contact block mounting adapter. Then turn the locking lever in the opposite direction.

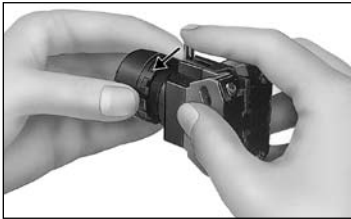

• Removing and Installing the Transformer Unit on Pilot Lights

1. Insert a flat screwdriver (5mm wide at the maximum) into the latch hole on the transformer unit as shown in the photo below, and disengage the latch. Then pull out the illumination unit.
2. To reinstall, place the TOP marking on the illumination unit and the latch in the same direction, and push the illumination unit into the transformer unit.

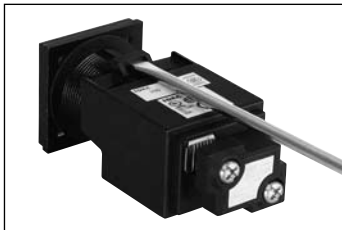

• Notes for Panel Mounting

1. When mounting the operator onto a panel, use the optional locking ring wrench (MW9Z-T1) to tighten the locking ring. Tightening torque must not exceed 2.0 N.m. Do not use pliers. Excessive tightening will damage the locking ring.
2. For the contact blocks and transformers housing LED and incandescent lamps, make sure not to press the lamps too hard, otherwise the lamp socket may be impaired.

• Notes for Illuminated Pushbuttons

The full shroud cannot be removed from the extended full shroud type.

Safety Lever Lock

IDEC strongly recommends using the safety lever lock (HW9Z-LS, yellow) to prevent heavy vibration or maintenance personnel from unlocking contacts.

1. HW series can be mounted vertically with a minimum spacing of 50 mm (70 mm for mono-lever switches) but spacing should be determined to ensure easy operation.
2. Mount the control unit onto the panel, lock the lever, and strongly push in the safety lever lock to install.

3. When the spacing is narrower than the recommended value, with the lever unlocked, mount the safety lever lock and insert the contact unit to the operator. Then, lock the lever and strongly push in the safety lever lock to install.
4. To remove the safety lever lock, insert a flat screwdriver into the safety lever lock and push upwards.

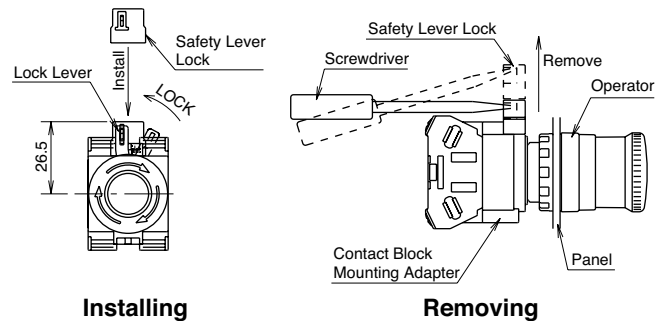

When removing safety lever, make sure that the screwdriver does not touch the contact block.

Ring Adapter

• HW9Z-A25

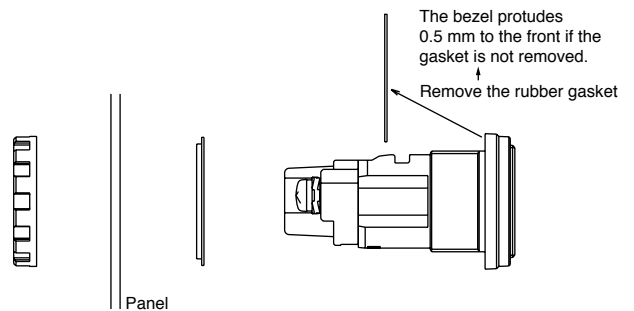

Dimensions

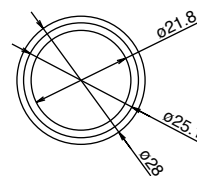

Panel cut-out



Instructions

• HW9Z-A30

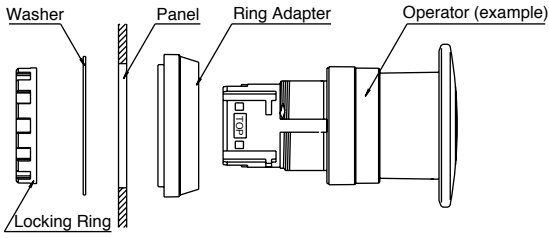

Dimensions

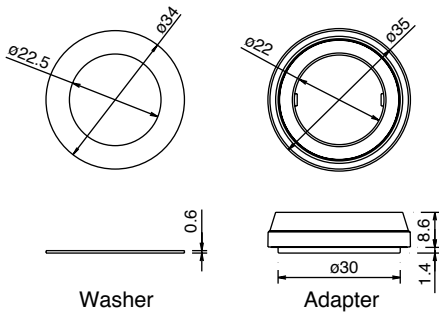

Panel-Cut

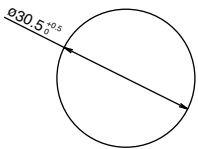

Replacement of Lens and Marking Plate

• Removing

1. Remove the lens unit (color lens, marking plate, and lens holder) by inserting a screwdriver into the recess of the lens through the bezel.

[Removing the Lens Unit]

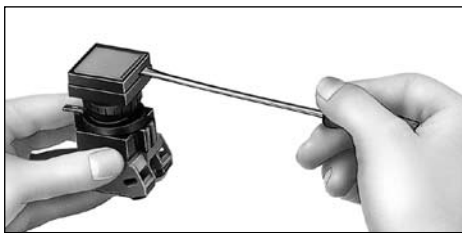

2. Remove the marking plate by pushing the lens from the rear to disengage the latches between the lens and the lens holder, using the screwdriver as shown below.

[Removing the Lens]

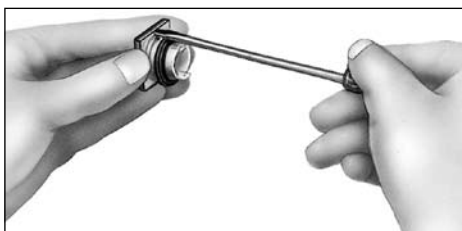

Note: The translucent filter in the lens holder cannot be removed because this filter is sealed to make the unit waterproof and oiltight.

• Installing

[For Round Lens Type]

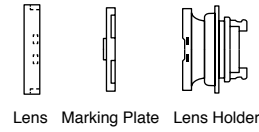

1. Place the marking plate on the lens holder with the anti-rotation projection engaged and press the lens onto the lens holder to engage the latches.
2. Place the marking plate in the correct orientation.

[For Square Lens Type]

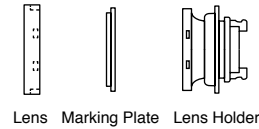

1. Place the marking plate on the lens holder and press the lens onto the lens holder to engage the latches.
2. Place the marking plate in the correct orientation.

Marking

For HW series illuminated pushbuttons and pilot lights, legends and symbols can be engraved on the built-in marking plates, or printed film can be inserted under the lens for labeling purposes. Films are not supplied with illuminated pushbuttons, and may be provided by the user.

• Marking Plates and Marking Film Size

Lens Style	Round Lens Type	Square Lens Type
Built-in Marking Plate		
Applicable Marking Film		
	<ul style="list-style-type: none"> • Engraving must be made on the engraving area within 0.5mm deep. • The marking plate is made of white acrylic resin. 	<ul style="list-style-type: none"> • Mylar for printing labels is not supplied and must be provided and printed by the user. • Two 0.1mm-thick films or one 0.2mm-thick film can be installed in the lens. • Recommended marking film: Mylar

• Insertion Order of Marking Plate and Film

[Round Lens Type]

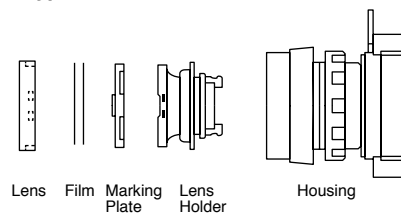

Note: Films are not supplied.

Instructions

[Square Lens Type]

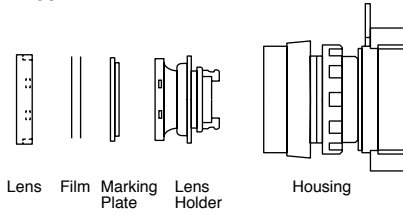

Note: Films are not supplied.

Replacement of Lens for Dual Pushbuttons

• Removing

Remove the lens by inserting a screwdriver into the recess of the lens through the bezel.

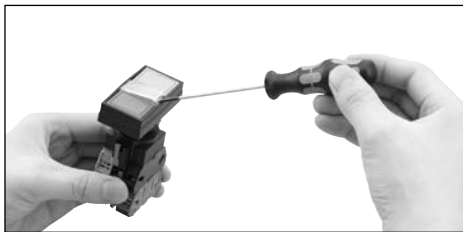

• Installing

Install the lens in the recess between the buttons by pressing against the bezel.

Replacement of Lamps

Lamps can be replaced by using the lamp holder tool (OR-55) from the front of the panel, or by removing the contact block from the operator unit.

• Removing the Lamps from the Front of the Panel

[How to Remove]

- To remove, slip the lamp holder tool onto the lamp head lightly. Then push slightly, and turn the lamp holder tool counterclockwise.



[How to Install]

- To install, insert the lamp head into the lamp holder tool, and hold the lamp as shown in the figure below.

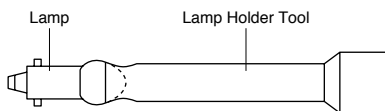

- Place the pins on the lamp base to the grooves in the lamp socket. Insert the lamp and turn it clockwise.

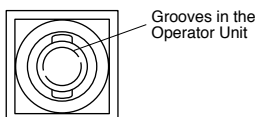

Nameplate

When anti-rotation is not required, remove the projection from the nameplate using pliers.

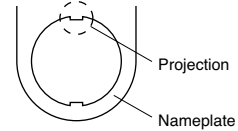

Close Mounting

When mounting the units closely in a horizontal row on 30 mm centers, use optional barriers to prevent interconnection between adjoining terminals. The barriers can be attached simply by pressing them onto the sides of contact blocks.

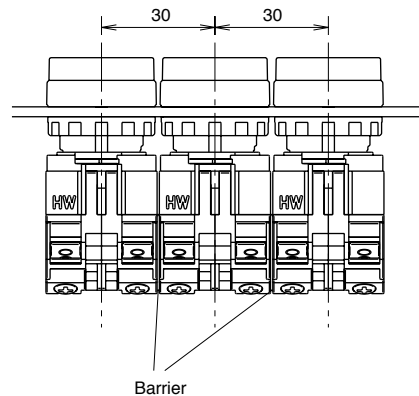

When mounting transformer type illuminated units closely in a horizontal row on 30 mm centers, insert solid wires or stranded wires into inside of the terminal screw on the transformer (see figure below) to prevent short circuit between adjoining terminals.

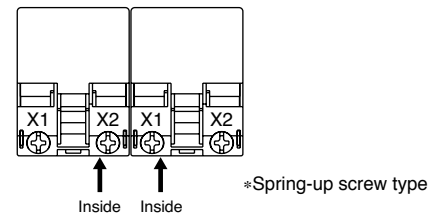

When using transformer type pilot lights closely mounted in horizontal and vertical rows on 30 mm centers, keep the ambient temperature below 40°C.

Tightening Torque for Terminal Screws

Tighten the M3.5 terminal screws to a torque of 1.0 to 1.3 N·m.

Installation of LED Illuminated Units

- When using full voltage type LED illuminated units, provide protection against electrical noise, if necessary.
- Notes for Pure White LED Lamps
 - Do not use the pure white LED outdoors, otherwise it will lead to the degradation of brightness and color. Do not remove or apply shock to the cap on the pure white LED lamp, otherwise it may break or damage the cap.
 - Use a white lens. The illumination color will be dull if a different color lens is used.

Instructions

Applicable Wiring

The applicable wire size is 2mm² maximum. (Solid wire ϕ 1.6 mm max.) One or two wires can be connected.

• Applicable Crimping Terminal (for spring-up screw terminal)

Crimping terminal for (A)

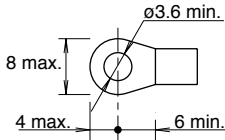

Crimping terminal for (B)

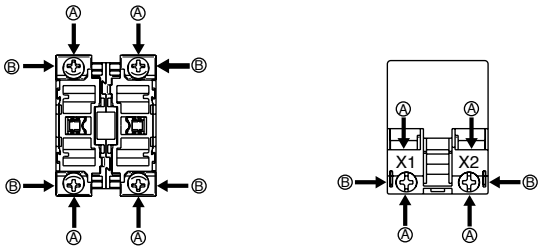
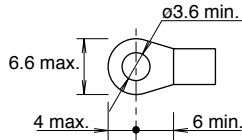

*Spring-up screw type

Be sure to use an insulation tube or cover on the crimping part of the crimping terminal to prevent electrical shocks.

• Solid Wire

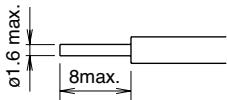

Anti-rotation Ring and Panel Cut-out

Align the TOP marking on the operator and the ▲ mark on the anti-rotation ring with the recess in the mounting panel.

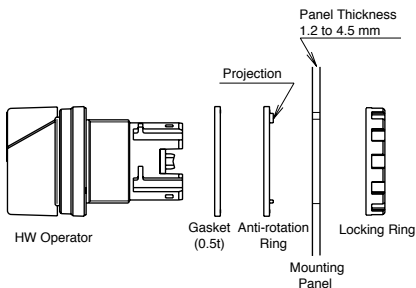

• Panel Cut-out

(Complies with IEC60947-5-1)

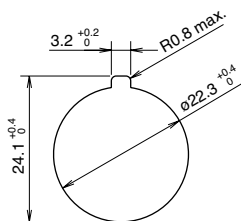

Unibody Pushlock Turn Reset

• Removing the lens

Remove the lens by inserting a screwdriver into the left or right recess of the lens. Be careful that the lens does not drop off.

• Removing the LED/incandescent lamp

Use a lens removal tool to remove the lamp. See page 54 for more information.

• Notes for Wiring

Ensure that the crimping terminal of each wiring is properly insulated.

Selector Switch

Be sure to turn the knob or key securely to each operator position.

Key Selector Switch

• Notes for using a different key

When a different number key is inserted into the key hole, it will not normally operate. However, if the key is forced to turn or is not inserted properly, it may be turned.

Notes on Dual Pushbutton Switches

The pushbuttons cannot be removed or replaced. Do not attempt to remove using a flat screwdriver or pincers, otherwise the pushbuttons may be damaged.

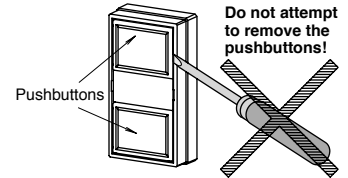

Installing the Rubber Boot for Dual Push-buttons

When using the HW7D pushbuttons in places where the pushbuttons are subject to water splash or an excessive amount of dust, make sure to use the HW9Z-D7D rubber boot (IP65) which is ordered separately.

• Notes for Installing the Rubber Boot

Remove the gasket from the operator, and install the rubber boot on the operator. Pull out the seals of the rubber boot and place them around the operator sleeve as shown. Make sure that the seals are not twisted or tucked inside and that the gasket does not remain, otherwise the normal waterproof and dustproof characteristics are not ensured.

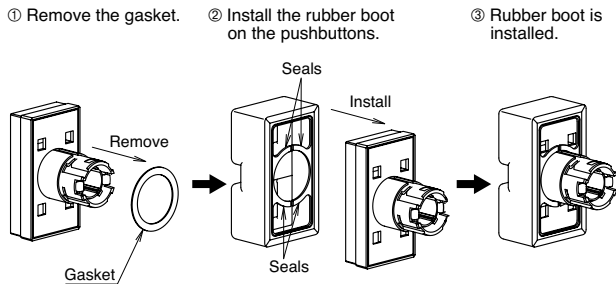



Control Stations

Control Station (Gray Cover)

Shape	Contact	Type No.	Button Color	Mounted Unit (Operator)
With Pushbutton HW1X-BM 	1NO	HW1X-BM110①	Specify a button color code in place of ① in the Type No. B: black G: green R: red S: blue W: white Y: yellow	HW1B-M1
	1NO-1NC	HW1X-BM111①		

Shape	No. of Positions	Contact Code	Contact Block		Operator			Type No.	Mounted Unit (Operator)
			Mounting Position	Type	L	C	R		
With Selector Switch HW1X-S 	90° 2-position Maintained	10 (1NO)	1	NO		—	●	HW1X-S2T10	HW1S-2T
			2	Dummy					
		11 (1NO-1NC)	1	NO		—	●		
			2	NC	●	—			
	45° 3-position Maintained	20 (2NO)	1	NO	●			HW1X-S3T20	HW1S-3T
			2	NO			●		

Emergency Stop Control Station (Yellow Cover)

Shape	Contact	Type No.	Button Color	Mounted Unit (Operator)
With Pushlock Turn Reset Switch HW1X-BV 	1NC	HW1X-BV401R	Red only	HW1B-V4R
	1NO-1NC	HW1X-BV411R		
	2NC	HW1X-BV402R		
With Pushlock Key Reset Switch HW1X-BX 	1NC	HW1X-BX401R	Red only	HW1B-X4R
	1NO-1NC	HW1X-BX411R		
	2NC	HW1X-BX402R		

Accessories

Name	Type No.	Ordering Type No.	Package Quantity	Remarks
Nameplate	NSA-0	NSA-0	1	Black surface, made of aluminum 1.2 mm thick
		NSA-0PN10	10	
Cover Gasket	HW9Z-W	HW9Z-WPN05	5	Made of rubber
Connector Locking Nut	HW9Z-G	HW9Z-GPN05	5	Made of white plastic, G1/2 thread
	HW9Z-PG	HW9Z-PGPN05	5	Made of black plastic, PG16 thread

Ordering Information

- Unless otherwise specified, every control station is supplied with two connector locking nuts (G1/2 thread).
- When using PG16 connectors, specify as described below.

HW1X-BM110① - PG

————— Supplied with two PG16 connector locking nuts

Specifications

Operating Temperature	-25 to +60°C (no freezing)
Storage Temperature	-40 to +80°C (no freezing)
Operating Humidity	45 to 80% RH (no condensation)
Rated Insulation Voltage	600V
Contact Resistance	50 mΩ maximum (initial value)
Insulation Resistance	100 MΩ minimum (500V DC megger)
Electric Shock Protection Class	Class II (IEC 61140)
Dielectric Strength	Between live and dead parts: 2,500V AC, 1 minute
Vibration Resistance	Operating extremes: 5 to 55 Hz, amplitude 0.5 mm Damage limits: 30 Hz, amplitude 1.5 mm
Shock Resistance	Operating extremes: 100 m/s ² Damage limits: 1,000 m/s ²
Mechanical Life (minimum operations)	Pushbuttons, momentary: 5,000,000 Selector switches: 500,000 Pushlock turn reset switches: 500,000 Pushlock key reset switches: 500,000
Electrical Life (minimum operations)	Pushbuttons, momentary: 500,000 *1 Selector switches: 500,000 *2 Pushlock turn reset switches: 500,000 *3 Pushlock key reset switches: 500,000 *3 (Switching frequency) *1 1,800 operations/h, duty ratio 40% *2 1,200 operations/h, duty ratio 40% *3 900 operations/h, duty ratio 40%
Conduit Port	ø23 mm knockout on top and bottom
Applicable Connector	G1/2 or PG16 (plastic fitting)
Applicable Wire	Solid wire: ø1.6 mm maximum Stranded wire: 2.0 mm ² maximum
Mounting Screw	Two M4 screws Tightening torque 1.4 to 2.0 N·m
Degree of Protection	IP65 (IEC 60529)
Weight (approx.)	157g (HW1X-BM111)

Contact Ratings

Contact Block	Rated Insulation Voltage	600V
	Rated Thermal Current	10A
	Contact Ratings by Utilization Category IEC 60947-5-1	AC-15 (A600) DC-13 (P600)

Applicable Standards and Approvals

Safety Standards	Mark	File No. or Organization
UL508 CSA C22.2 No. 14		UL Listing File No. E68961
EN60947-5-1		TÜV SÜD

Attachments

Name	Type No.	Quantity
Nameplate	*1 NSA-0	1
Cover Gasket	*2 HW9Z-W	1
Connector Locking Nut	HW9Z-G	2

For details, see the instruction sheet attached to the control station.

- *1: The nameplate is supplied with the pushbutton and selector switch control stations, not with the emergency stop control station.
- *2: The cover gasket is supplied with the emergency stop control station, not with the pushbutton and selector switch control stations.

Characteristics

•Contact Ratings by Utilization Category

Operational Voltage			24V	48V	50V	110V	220V	440V
Operational Current	AC 50/60 Hz	AC-12 Control of resistive loads and solid state loads	10A	—	10A	10A	6A	2A
		AC-15 Control of electromagnetic loads (> 72 VA)	10A	—	7A	5A	3A	1A
	DC	DC-12 Control of resistive loads and solid state loads	8A	4A	—	2.2A	1.1A	—
		DC-13 Control of electromagnets	4A	2A	—	1.1A	0.6A	—

Note: The operational current represents the classification by making and breaking currents (IEC 60947-5-1).

Minimum applicable load: 3V AC/DC, 5 mA (Applicable range may vary with operating conditions and load types.)

Dimensions

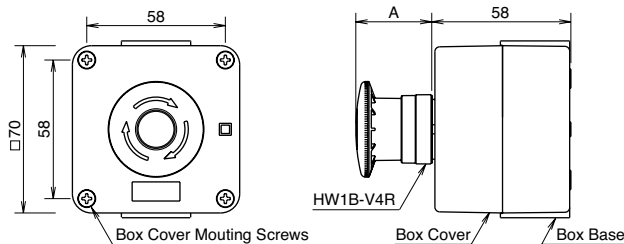

Control Unit (Operator)	Dimension A (mm)
Pushbutton	13.0
Selector Switch	21.0
Pushlock Turn Reset	32.0
Pushlock Key Reset	32.0 (Key inserted: 49.4)

Mounting Hole Layout

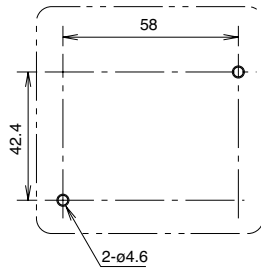

Applicable Terminal

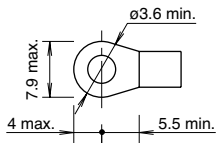

Tightening torque: 1.0 to 1.3 N·m
A maximum of two pieces can be connected to one terminal.

• Applicable Connector and Installation

- To install a connector, break open the conduit port on the top and bottom of the control station. Before opening the conduit port, remove the attached two connector locking nuts from the control station base. Place the tip of a screwdriver on the conduit port and strike the screwdriver end. Make sure that the conduit port is free from burrs and cracks, which may hamper waterproof characteristics.

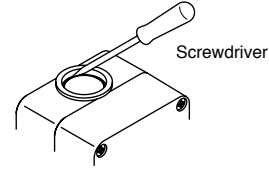

- Use G1/2 or PG16 connectors which can mount on a panel of 4.0 mm thick minimum. To install the connector to the control station, use the attached connector locking nut and tighten the locking nut sufficiently. If the locking nut is tightened insufficiently, the waterproof characteristics are not ensured.

Thread Size	Locking Nut Color	Locking Nut Type No.
G1/2	White	HW9Z-G
PG16	Black	HW9Z-PG

Nameplate

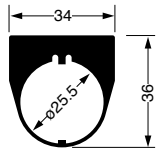
Type No.	NSA-0
Color: Black, without legend Thickness: 1.2 mm (Remove the anti-rotation projection)	
Material	Aluminum

The nameplate is supplied with the pushbutton and selector switch control stations. When not using the nameplate, use the cover gasket (HW9Z-W).
HW series nameplates (HWA*) cannot be used.

Locking Nut for Installing Connector (supplied with control station)

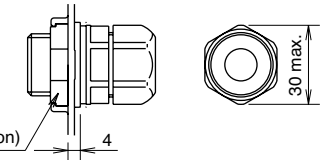

- Only when using a plastic connector, Insulation Class II (IEC 61140) is satisfied.
- Install the enclosure cover flat on the enclosure base. When the enclosure cover is installed diagonally, the enclosure cover cannot be secured correctly, resulting in an operation error.

• Applicable Cables

Applicable CVV Cable	Outside Diameter	Core Wires
1.25 mm ²	Ø14.5 mm maximum	8 maximum
2.0 mm ²	Ø14.5 mm maximum	8 maximum

• Applicable Conduits

Metal Conduit Outside Diameter	Ø10 mm	Ø12 mm
Conduit Inside Diameter	Ø8.3 mm minimum	Ø10.6 mm minimum
IV Wire Quantity	1.25 mm ²	2 to 3
	2.0 mm ²	2 to 3
		3 to 4

Wire containment density: 32% to 48%
Select a cable appropriate for the connector.

Operating Instructions

• Panel Mounting

To mount the control station on a panel, use two M4 screws, plane washers and spring washers to preventing loosening. Tighten the screws to a torque of 1.4 to 2.0 N·m.
Determine the screw length in consideration of the panel thickness.

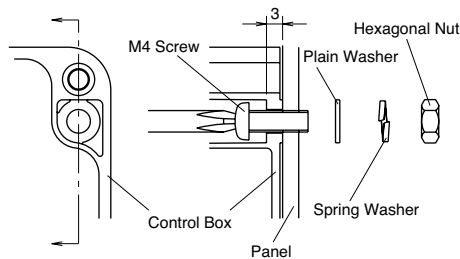

Specifications and other descriptions in this catalog are subject to change without notice.



IDEC CORPORATION

7-31, Nishi-Miyahara 1-Chome, Yodogawa-ku, Osaka 532-8550, Japan
Tel: +81-6-6398-2571, Fax: +81-6-6392-9731
E-mail: marketing@idec.co.jp

IDEC CORPORATION (USA)
1175 Elko Drive, Sunnyvale, CA 94089-2209, USA
Tel: +1-408-747-0550 / (800) 262-IDEC (4332)
Fax: +1-408-744-9055 / (800) 635-6246
E-mail: opencontact@idec.com

IDEC CANADA LIMITED
3155 Pepper Mill Court, Unit 4, Mississauga,
Ontario, L5L 4X7, Canada
Tel: +1-905-890-8561, Toll Free: (888) 317-4332
Fax: +1-905-890-8562
E-mail: sales@ca.idec.com

IDEC AUSTRALIA PTY. LTD.
2/3 Macro Court, Rowville, Victoria 3178, Australia
Tel: +61-3-9763-3244, Toll Free: 1800-68-4332
Fax: +61-3-9763-3255
E-mail: sales@au.idec.com

IDEC ELECTRONICS LIMITED
Unit 2, Beechwood, Chineham Business Park,
Basingstoke, Hampshire RG24 8WA, UK
Tel: +44-1256-321000, Fax: +44-1256-327755
E-mail: sales@uk.idec.com

IDEC ELEKTROTECHNIK GmbH
Wendenstrasse 331, 20537 Hamburg, Germany
Tel: +49-40-25 30 54 - 0, Fax: +49-40-25 30 54 - 24
E-mail: service@idec.de

IDEC (SHANGHAI) CORPORATION
Room 608-609, 6F, Gangtai Plaza, No. 700,
Yan'an East Road, Shanghai 200001, PRC
Tel: +86-21-5353-1000, Fax: +86-21-5353-1263
E-mail: idec@cn.idec.com

IDEC (BEIJING) CORPORATION
Room 211B, Tower B, The Grand Pacific Building,
8A Guanghua Road, Chaoyang District,
Beijing 100026, PRC
Tel: +86-10-6581-6131, Fax: +86-10-6581-5119

IDEC (SHENZHEN) CORPORATION
Unit AB-3B2, Tian Xiang Building, Tian'an Cyber Park,
Fu Tian District, Shenzhen, Guang Dong 518040, PRC
Tel: +86-755-8356-2977, Fax: +86-755-8356-2944

IDEC IZUMI (H.K.) CO., LTD.
Units 11-15, Level 27, Tower 1,
Millennium City 1, 388 Kwun Tong Road,
Kwun Tong, Kowloon, Hong Kong
Tel: +852-2803-8989, Fax: +852-2565-0171
E-mail: info@hk.idec.com

IDEC TAIWAN CORPORATION
8F-1, No. 79, Hsin Tai Wu Road, Sec. 1,
Hsi-Chih, Taipei County, Taiwan
Tel: +886-2-2698-3929, Fax: +886-2-2698-3931
E-mail: service@tw.idec.com

IDEC IZUMI ASIA PTE. LTD.
No. 31, Tannery Lane #05-01,
HB Centre 2, Singapore 347788
Tel: +65-6746-1155, Fax: +65-6844-5995
E-mail: info@sg.idec.com

X-ON Electronics

Largest Supplier of Electrical and Electronic Components

Click to view similar products for [idec manufacturer](#):

Other Similar products are found below :

[LT7A-XE-G](#) [LT7A-XE-R](#) [LT7B-A250](#) [LT7B-A250FB](#) [LW1B-M1C6-W](#) [LW6L-M1C24MG](#) [FB1T-000Z](#) [FB1W-XW1E-BV411MR](#) [FB3W-413Z](#) [FC2A-KP1C](#) [FC4A-J8AT1](#) [FC4A-T16S3](#) [FC5A-C16R2C](#) [MM-SMART-24](#) [MM-SMART-40](#) [FT1A-C12RA-S](#) [FT1A-C12RA-W](#) [FT1A-C14SA-B](#) [PF3S-BP12](#) [PS3X-D24AFG](#) [PS3X-Q12AFG](#) [GT3A-3AD24](#) [GT3F-2EAD24](#) [GT3S-2AF20](#) [GT3W-A16AD24](#) [ABD302N-R](#) [ABD410N-R](#) [ABFD411N-G](#) [ABN4F11-G](#) [ABPD201N-R](#) [HE2B-M211PB](#) [HE2G-21SH](#) [HE9Z-D3B](#) [HG9Z-2A1](#) [HG9Z-XC300](#) [ACSNO-6123-FB-C6002](#) [RH3V2-UAC240V](#) [DFAN-031-B](#) [AL6M-LK1-G](#) [AL6M-P3-R](#) [AL6Q-M13-W](#) [AL6Q-M23P-QG](#) [ALFD29901DN-G-24V](#) [ALFN22211DNG-U](#) [ALFW224611D-W](#) [ALNE8811-G](#) [ALQW2B24611D-G](#) [ALW212611-G](#) [ALW22211DG](#) [ALW29902D-G-12V](#)