



INSTRUCTION SHEET
Original Instructions
Solenoid Type Safety Switch
HS5L Series



Confirm that the delivered product is what you have ordered. Read this instruction sheet to make sure of correct operation. Make sure that the instruction sheet is kept by the end user.

SAFETY PRECAUTIONS

In this operating instruction sheet, safety precautions are categorized to Caution:

WARNING

Warning notices are used to emphasize that improper operation may cause severe personal injury or death.

CAUTION

Caution notices are used where inattention might cause personal injury or damage to equipment.

1 Type

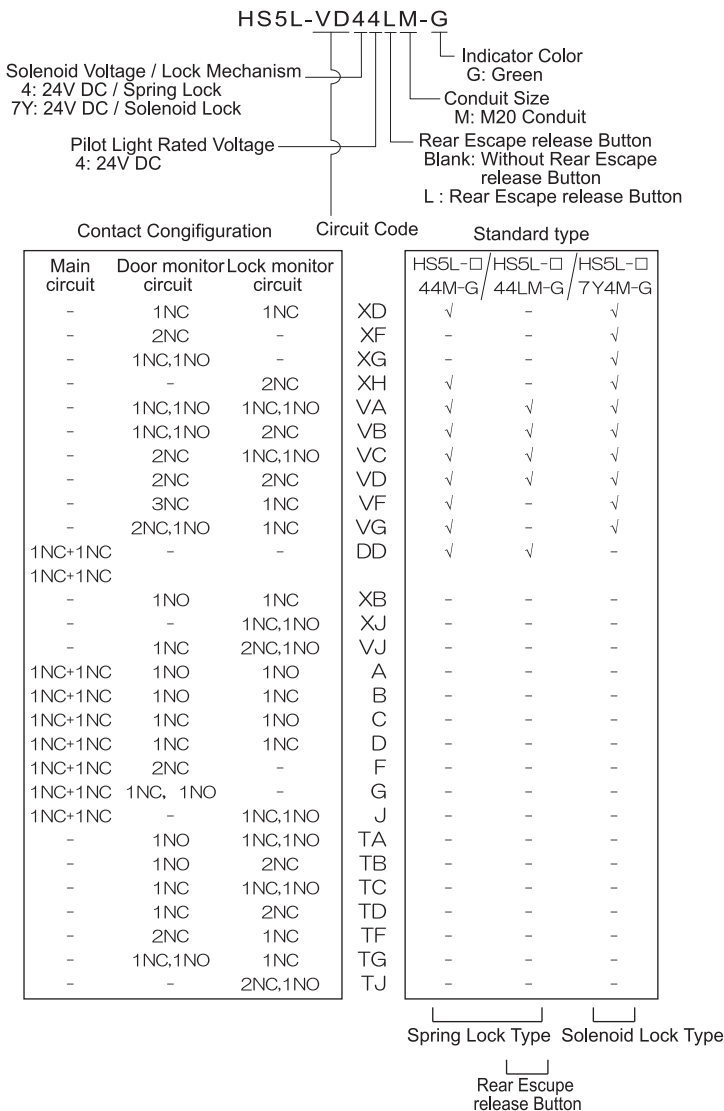

*1 Only type No. on √ mark are supplied as standard. Contact IDEC for the other if required.

CAUTION

Solenoid lock type

- This safety switch is designed to lock the actuator while the solenoid is energized and to release it when deenergized.
- When the power to the solenoid is interrupted by accident, such as disconnection, the lock is released before a machine stops completely. Then, the worker may be exposed to hazards.
- This safety switch can be used only for limited applications which do not especially need to be locked for safety.

2 Specifications and Ratings

Applicable Standards	EN ISO14119, IEC60947-5-1, EN60947-5-1, GS-ET-19, UL508, CSA C22.2 No.14, GB 14048. 5					
Standards for Use	IEC60204-1/EN60204-1					
Interlocking device Type / the level of coded	Type 2 Interlocking device / low level coded actuator (ISO14119)					
Applicable Directives	Low Voltage Directive (2006/95/EC) Machinery Directive (2006/42/EC)					
Operating Condition	Operating Temperature	-25 to +55°C (no freezing)				
	Operating Humidity	20 to 95%RH (no condensation)				
	Pollution Degree	3 (Inside 2)				
Altitude	2000m maximum					
Impulse withstand voltage <Uimp>	2.5kV (Between ground and LED, solenoid circuit : 0.5kV)					
Raed Insulation voltage <Ui>	250V (Between ground and LED, solenoid circuit : 30V)					
Thermal Current <Ith>	2.5A					
Contact Ratings (Reference Values) < Ue, Ie > *2	AC	Resistive load (AC12)	-	30V	125V	250V
		Inductive load (AC15)	-	2.5A	1.5A	1.5A
	DC	Resistive load (DC12)	2.5A	1.1A	0.55A	0.55A
		Inductive load (DC13)	2.3A	0.55A	0.27A	0.27A
Class of Protection	Class II (IEC61140) *3					
Operating Frequency	900 operations/hour					
Operating Speed	0.05 to 1.0 m/s					
B10d	2,000,000 (ISO 13849-1 Annex C Table C.1)					
Mechanical durability	2,000,000 operations minimum (GS-ET-19) the Rear Escape release Button: 3000 operations minimum (Type HS5L-□L)					
Electrical Durability	100,000 operations min. (AC-12 250V/1.5A) 2,000,000 operations min. (AC/DC 24V 100mA) (900 operations / hour)					
Actuator Tensile Strength when Locked	Fzh=1,400N minimum F1max=1820N minimum (GS-ET-19) *4, *5 (Fzh=500N minimum : HS9Z-A55 actuator)					
Direct Opening Travel	11 mm minimum (actuator: HS9Z-A51,A5P) 12 mm minimum (for other actuators)					
Direct Opening Force	120N minimum					
Contact Resistance	50 mΩ maximum (initial value)					
Degree of Protection	IP67 (IEC60529) ,Type 4X Indoor Use Only					
Conditional short circuit current	50A(250V)					
Short-circuit Protective Device	Use 250V / 10A fast acting type fuse *6					
Solenoid	Rated Operating Voltage	DC24V 100% duty cycle				
	Rated Current	200 mA (initial value)				
	Turn ON Voltage	Rated voltage x 85% maximum (at 20°C)				
	Turn OFF Voltage	Rated voltage x 10% minimum (at 20°C)				
Indicator	Rated Power Consumption	Approx. 5W				
	Rated Operating Voltage	DC24V 100% duty cycle				
	Rated Current	10 mA				
	Light Source	LED				
	Illumination Color	Green				

*2:Ratings approved by safety agencies

- (1)TUV/CCC rating AC-15 250V/0.75A
DC-13 30V/2.3A

- (2)UL , c-UL rating AC-15 250V/0.75A : Pilot Duty
DC-13 30V/2.3A : Pilot Duty

*3:Basic insulation of 2.5kV impuse withstand circuits and between contact circuit SELV(safety extra low voltage) or circuits (such as 230V AC circuits) at the same time, the SELV or PELV arequirements are met any more.

*4:The actuator locking strength is rated at 1400N of static load. Do not apply a load higher than the rated value. When a higher load is expected to work on the actuator, provide an additional system consisting of another safety switch without lock (such as the HS5D safety switch) or a sensor to detect door opening and stop the machine.

*5:F1max is maximum force. The actuator's guard-locking force FZh is calculated in accordance with GS-ET-19:

$$FZh = \frac{\text{maximum force (F1max)}}{\text{Safety coefficient (=1.3)}}$$

*6:Make sure that a fast acting fuse for short-circuit protection trips before overheating of the wires.



3 Mounting Examples

- Install the interlock switch on the immovable machine or guard, and install the actuator on the movable door. Do not install both interlock switch and actuator on the movable door, otherwise failure will occur.
- See the figures below.

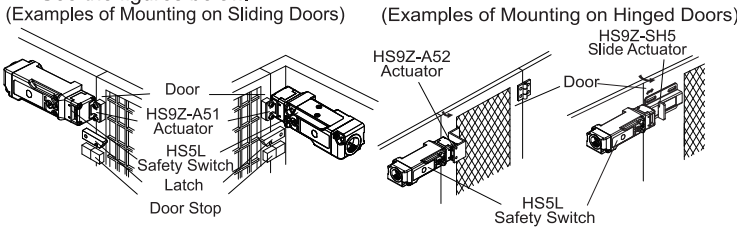

The HS5L Head

- Changing the Mounting Directions of the HS5L Head
The head of the HS5L can be mounted in four directions by removing the four screws from the corners of the HS5L head.

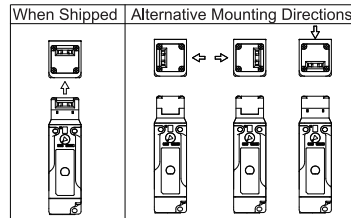

WARNING

Mounting Directions of the HS5L Head

- Before changing the mounting direction of the HS5L head, turn the manual unlock to UNLOCK using the attached manual unlock key or disconnect wiring from the HS5L.
- If the head position is changed after wiring without taking the above action, the machine may start to operate and the worker may face danger.
- When replacing the HS5L head, make sure that no foreign object enters into the safety switch. Tighten the screws tightly, without leaving space between the head and body, otherwise the safety switch may malfunction.
- Don't remove the screws of head except when the mounting directions of head is changed.

Mounting the Head

- Do not use the metallic or plastic head for the HS5D (without lock type). Be sure to use the head for the HS5L and mount the correct head. Take care particularly when using with the HS5D (without lock type).

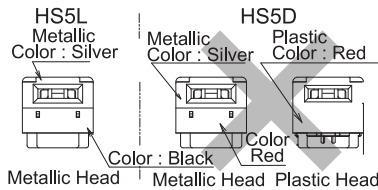

HS5L Head Removal Detection Function (Only Spring Lock Type)

- When the actuator is operated, the operation of the monitor circuit (11-42) and (51-52) are the same. However, when the head is removed, disparity is detected (11-42: OFF, 51-52: ON). The disparity of the contacts detects the removal of the head.

	(+) A2	(-) A1	ACTUATOR UNLOCK	ACTUATOR LOCK	HEAD REMOVE
Lock Monitor Circuit (NC) ⊖ 41	⊕ 42				
Lock Monitor Circuit (NC) ⊖ 51	⊕ 52				

CAUTION

■ : Contact Closed □ : Contact Open

- The Head Removal Detection Function cannot be used with HS5L solenoid lock type products.
- When the head is removed from the device (e.g. when changing the mounting position of the head), the 41-42 lock monitor circuit opens (OFF position) and 51-52 monitor circuits close (ON position); so please make sure you connect the 41-42 lock monitor circuit to a safety circuit if you want to use the Head Removal Detection Function.
- The Head Removal Detection Function can only be used with the following spring-lock circuits: A,B,C,D,F,G, J, DD, VB, VD, VJ, TB, TD and TJ type circuits. This function cannot be used with other spring-lock type circuits and solenoid circuits.

(Type HS5L-□L)

Installing the rear escape release button

- After installing the interlock switch on the panel, put the rear escape release button (supplied) on the rod on the back of the interlock switch, and fasten using the mounting screw. When installing on the aluminum frame of the thickness of 6mm or more, use the rear escape release button for frame kit (HS9Z-FL5□) sold separately.

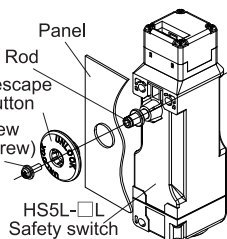

CAUTION

After installing the rear escape release button, apply Loctite to the screw so that the screw does not become loose. The rod is made of stainless steel. The rear escape release button is glass-reinforced PA66 (66 nylon). The mounting screw is iron. Take the compatibility of plastic material and Loctite into consideration.

Minimum Radius of Hinged Door

- When using the safety switch for a hinged door, the minimum radius of the applicable door is shown in the following figures.

When the center of the hinged door is on the extension line of the actuator mounting surface.

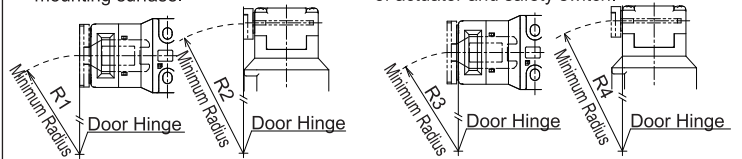

	Minimum Radius			
	R1	R2	R3	R4
HS9Z-A52	230 mm	260 mm	170 mm	190 mm
HS9Z-A52	Mounting centers:12 mm	230 mm	120 mm	140 mm
	Mounting centers:20 mm	310 mm	170 mm	
HS9Z-A53		80 mm (Vertical Swing)		50 mm (Vertical Swing)
HS9Z-A55	70 mm (Horizontal Swing)	70 mm (Vertical Swing)	50 mm (Horizontal Swing)	50 mm (Vertical Swing)

CAUTION

The values shown above are based on the condition that the actuator enters and exits the actuator entry slot smoothly when the door is closed or opened. Since there may be deviation or dislocation of the hinged door, make sure of correct operation in the actual application before installation.

(Type HS9Z-A53/A55)

Adjusting the Angle Adjustable (vertical/horizontal) Actuator

- Using the angle adjustment screw (M3 hexagon socket set screw), the actuator angle can be adjusted up to 20° (refer to dimensions).
- The larger the actuator angle, the smaller the applicable radius of the door swing.
- After installing the actuator, open the door. Then adjust the actuator angle so that the actuator enters the entry slot of the safety switch properly.
- After adjusting the actuator angle, apply loctite or the like on the adjustment screw to prevent loosening.

(Type HS9Z-A53)

- Tightening torque of angle adjustment screw : 0.8 Nm.

(Type HS9Z-A55)

- Use screw locking agent that is compatible with the base material.
Base: PA66 (66 nylon) of glass reinforced grade
Angle adjustment screws: stainless steel

Actuator Mounting Reference Position

As shown below, the mounting reference position of the actuator inserted into the safety switch is:

(Type HS9Z-A53)

The actuator stop film placed on the actuator touches the safety switch lightly.

(Except Type HS9Z-A53)

The actuator and actuator cover touches the actuator stop placed on the safety switch lightly.

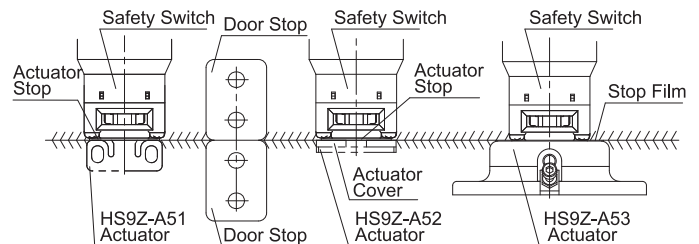

Actuator Mounting Tolerance

- Mounting tolerance of the actuator is 1.0 mm in the four lateral directions.
- When closing the door, the actuator is inserted and locked within a certain distance from the reference position. After the actuator has been locked, the contact operation is not affected by the actuator movement in the locked state.

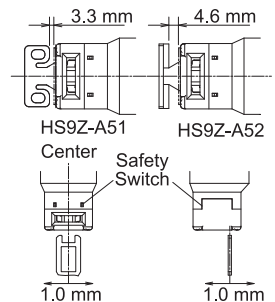

	(Actuator deviation) + (Door movement)
HS9Z-A51	≤ 3.3mm
HS9Z-A52	
HS9Z-A51A	≤ 4.6mm
HS9Z-A52A	
HS9Z-A53	≤ 5.6mm
HS9Z-A55	≤ 4.6mm

For Type HS9Z-A51A/A52A actuator

- When there is a displacement of safety switch and actuator, the actuator may hit the entry slot of safety switch hardy, thus damaging the entry slot and actuator. The rubber cushions on the HS9Z actuator prevent the actuator from damaging the entry slit by absorbing the shock with movement flexibility. Do not, however, exert excessive shocks, otherwise the failure of safety switch may be caused.
- The rubber cushions may deteriorate depending on the operating environment and conditions. Immediately replace the deformed or cracked rubber cushions with new ones.
(After mounting the actuator, remove the actuator stop from the safety switch.)

Recommended Screw Tightening Torque

Name or Use	Screw Tightening Torque
For mounting the safety switch (M4 screw) *7	1.8 to 2.2 N · m
For mounting the cover (M3screw)	0.5 to 0.7N · m
For mounting the HS5L head (M3)	0.9 to 1.1 N · m
For mounting the rear escape release button (M3 sems screw)	0.5 to 0.7 N · m
For mounting the actuator (HS9Z-A51: two M4 screws) *7	1.8 to 2.2 N · m
(HS9Z-A52: two M4 Phillips screws)	0.8 to 1.2 N · m
(HS9Z-A51A/A52A: two M4 screws) *7,8	1.0 to 1.5 N · m
(HS9Z-A53: two M6 screws) *7	4.5 to 5.5 N · m
(HS9Z-A55: two M4 screws) *7	1.0 to 1.5 N · m

CAUTION

- *7: When the torque is not enough to recommended screw tightening torque, make sure that the screw do not become loose by using adhesive sealants etc.
- *8: In the case of HS9Z-A51A and HS9Z-A52A, using two M4 screws and two attached washers, fasten the actuator securely on the door.

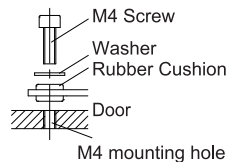

4 Precautions for Operation

For Mounting

- Do not apply an excessive shock to the safety switch when opening or closing the door.
A shock to the safety switch exceeding 1,000 m/s² may cause failure.
- Regardless of door types, do not use the safety switch as a door lock. Install a separate lock as shown in section 3.
- Entry of foreign objects in the actuator entry slot may affect the mechanism of the switch and cause a breakdown. If the operating atmosphere is contaminated, use a protective cover to prevent the entry of foreign objects into the switch through the actuator entry slots.
- While the solenoid is energized, the switch temperature rises approximately 40°C above the ambient temperature (to approximately 95°C while the ambient temperature is 55°C).
Keep hands off to prevent burns. If cables come into contact with the switch, use heat-resistant cables.
- Solenoid has polarity. Be sure to wire correctly. Do not apply voltage that exceed the rated voltage, otherwise the solenoid will be burnt out.
- Do not fasten and loosen the conduit at the bottom of the safety switch.
- Use the dedicated actuators only. Other actuators will cause damage to the switch.
- Be careful not to injure yourself with the screwdriver tip when wiring the terminals.
- Be careful not to damage the square-shaped screwdriver port when inserting the driver into it in order to wire the terminals. Inserting the screwdriver with too much strength may damage the product.

WARNING

- Turn off the power to the safety switch before starting installation, removal, wiring, maintenance, and inspection on the safety switch. Failure to turn power off may cause electrical shocks or fire hazard.
- Do not disassemble or modify the switch. Also do not attempt to disable the interlock switch function, otherwise a breakdown or an accident will result.

CAUTION

- HS5L Series Safety Switches are Type 2 low-level coded interlocking devices (ISO14119). The following system installation & mounting instructions are ISO14119 requirements to prevent function failure from the interlock switch.
- Using permanent fixing methods (e.g. welding, rivets, special screws...etc) to prevent dismantling or de-positioning of the interlock device. However, permanent fixing methods are not an adequate solution if you expect the interlock device to fail during the machinery lifetime, or if you need to replace the product in quick manner. In these situations, other measures (see 2.) should be put in place to reduce the risks of function failure.

- At least one of the following measures should be applied to prevent function failure.
 - Mounting the interlock device in a place out of reach from workers
 - Using shielding protection to prevent physical obstruction of the device
 - Mounting the interlock device in a hidden position
 - Integrate status monitoring & cycling testing of the device to the control system to prevent product failure.
- Regardless of door types, do not use the safety switch as a door stop. Install a mechanical door stop to the end of the door to protect the safety switch against excessive force.
- Mount the actuator so that it will not hit the operator when the door is open, otherwise injury may be caused.
- Pay attention to the management of spare actuator. Safety function of door interlock switch will be lost in case the spare actuator is inserted into the interlock switch. Ensure that the actuator is firmly fastened to the door (welding, rivet, special screw) in the appropriate location, so that the actuator cannot be removed easily.
- Do not cut or remodel the actuator, otherwise failure will occur.
- If multiple safety components are wired in series, the Performance Level to ISO13849-1 will be reduced due to the restricted error detection under certain circumstance.
- The insulation of the cable has to withstand environmental influences.
- The entire concept of the control system, in which the safety component is integrated, must be validated to ISO13849-2.

For Manual Unlocking

- To change the normal position to the manual unlocking position as shown above, turn the key fully (90 degrees) using the special key included with the switch.
 - Using the switch with the key being not fully turned (less than 90 degrees) may cause damage to the switch or errors.
 - When manually unlocked, the switch will keep the main and lock monitor circuit disconnected and the door unlocked.
- (Type HS5L-□4)
- The HS5L allows manual unlocking of the actuator to precheck proper door operation before wiring or turning power on, as well as for emergency use such as a power failure.
- (Type HS5L-□7Y)
- If the actuator is not unlocked although the solenoid is deenergized, the actuator can be unlocked manually.

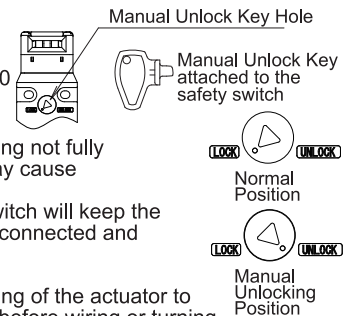

CAUTION

- Before manually unlocking the safety switch, make sure the machine has come to a complete stop. Manual unlocking during operation may unlock the switch before the machine stops, and the function of safety switch with solenoid is lost.
- While the solenoid is energized, do not unlock the actuator manually (solenoid lock type).
- Do not apply excessive force (0.45 N·m or more) to the manual unlock key. Otherwise the manual unlock switch will be damaged. Do not attach the key to the switch intentionally (the key is designed to fall off when the operator's hand is off the key).
- Do not leave the manual unlock key attached to the switch during operation. This is dangerous because the switch can always be unlocked while the machine is in operation.

(Type HS5L-□L)

For the Rear Escape release Button

- The Rear Escape release Button is used for an emergency escape when the orker is confined in the safety hedge (the dangerous area). (The Rear Escape release Button is according to ISO14119(2013), GS-ET-19)
- The lock is released when the Rear Escape release Button is pressed, and the door can be opened.
- To return to locked status, pull back the button. While the Rear Escape release Button is depressed, the main circuit remains open and the door is unlocked.

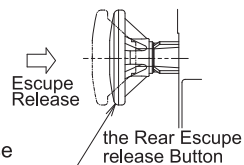

CAUTION

- Install the HS5L to ensure that a worker can operate the Rear Escape release Button from inside the safety hedge (the dangerous area). It is dangerous to install the HS5L in the position where the Rear Escape release Button can be operated from outside the the safety hedge (the dangerous area), because it is possible to unlock while the machine is operating.
- Use hand to press the button, and do not use a tool. Do not apply excessive force to the Rear Escape release Button.

5 Contact Operation

Contact Configuration and Operation

Type *10	Contact Configuration*11	Contact Operation(reference)
		0 (Actuator Mounting Reference Position) Approx. 3.3 (Lock) (Travel: mm) Approx. 5.3 Approx. 6.9 Approx. 26.4
HS5L-XD□	Monitor Circuit: 11-12 Monitor Circuit: 41-42	11-12 41-42
HS5L-XF□	Monitor Circuit: 11-12 Monitor Circuit: 21-22	11-12 21-22
HS5L-XG□	Monitor Circuit: 11-12 Monitor Circuit: 23-24	11-12 23-24
HS5L-XH□	Monitor Circuit: 41-42 Monitor Circuit: 51-52	41-42 51-52
HS5L-VA□	Monitor Circuit: 11-12 Monitor Circuit: 23-24 Monitor Circuit: 53-54	11-12 23-24 41-42 53-54
HS5L-VB□	Monitor Circuit: 11-12 Monitor Circuit: 23-24 Monitor Circuit: 51-52	11-12 23-24 41-42 51-52
HS5L-VC□	Monitor Circuit: 11-12 Monitor Circuit: 21-22 Monitor Circuit: 53-54	11-12 21-22 41-42 53-54
HS5L-VD□	Monitor Circuit: 11-12 Monitor Circuit: 21-22 Monitor Circuit: 51-52	11-12 21-22 41-42 51-52
HS5L-VF□	Monitor Circuit: 11-12 Monitor Circuit: 21-22 Monitor Circuit: 31-32	11-12 21-22 31-32 41-42
HS5L-VG□	Monitor Circuit: 11-12 Monitor Circuit: 21-22 Monitor Circuit: 33-34	11-12 21-22 33-34 41-42
HS5L-DD□	Main Circuit: 11-12 Main Circuit: 21-22	11-42 21-52
[HS5L-XB□]	Monitor Circuit: 13-14 Monitor Circuit: 41-42	13-14 41-42
[HS5L-XJ□]	Monitor Circuit: 41-42 Monitor Circuit: 53-54	41-42 53-54
[HS5L-VJ□]	Monitor Circuit: 11-12 Monitor Circuit: 51-52 Monitor Circuit: 63-64	11-12 41-42 51-52 63-64
[HS5L-A□]	Main Circuit: 11-12 Monitor Circuit: 23-24 Monitor Circuit: 53-54	11-42 23-24 53-54
[HS5L-B□]	Main Circuit: 11-12 Monitor Circuit: 23-24 Monitor Circuit: 51-52	11-42 23-24 51-52
[HS5L-C□]	Main Circuit: 11-12 Monitor Circuit: 21-22 Monitor Circuit: 53-54	11-42 21-22 53-54
[HS5L-D□]	Main Circuit: 11-12 Monitor Circuit: 21-22 Monitor Circuit: 51-52	11-42 21-22 51-52
[HS5L-F□]	Main Circuit: 11-12 Monitor Circuit: 21-22 Monitor Circuit: 31-32	11-42 21-22 31-32
[HS5L-G□]	Main Circuit: 11-12 Monitor Circuit: 21-22 Monitor Circuit: 33-34	11-42 21-22 33-34
[HS5L-J□]	Main Circuit: 11-12 Monitor Circuit: 51-52 Monitor Circuit: 63-64	11-42 51-52 63-64
[HS5L-TA□]	Monitor Circuit: 13-14 Monitor Circuit: 41-42 Monitor Circuit: 53-54	41-42 13-14 53-54
[HS5L-TB□]	Monitor Circuit: 13-14 Monitor Circuit: 41-42 Monitor Circuit: 51-52	41-42 13-14 51-52
[HS5L-TC□]	Monitor Circuit: 11-12 Monitor Circuit: 41-42 Monitor Circuit: 53-54	41-42 11-12 53-54
[HS5L-TD□]	Monitor Circuit: 11-12 Monitor Circuit: 41-42 Monitor Circuit: 51-52	41-42 11-12 51-52
[HS5L-TF□]	Monitor Circuit: 11-12 Monitor Circuit: 41-42 Monitor Circuit: 21-22	41-42 11-12 21-22
[HS5L-TG□]	Monitor Circuit: 11-12 Monitor Circuit: 23-24 Monitor Circuit: 41-42	41-42 11-12 23-24
[HS5L-TJ□]	Monitor Circuit: 41-42 Monitor Circuit: 51-52 Monitor Circuit: 63-64	41-42 51-52 63-64

(Actuator Completely Inserted) (Actuator Pulled Out)
 Contact Closed
 Contact Open

*10 Type No. in [] are not supplied as standard.
 See 1. Type for standard.
 *11 These are the image of locking position with actuator inserted.

Operation Cycle

• Spring Lock Type (HS5L-□4)

Door States	Closed	Closed	Open	Closed
Solenoid Power A1-A2	OFF	ON	ON/OFF	OFF
Manual Unlock Key	Turn the key to lock position	Turn the key to lock position	Turn the key to lock position	Turn the key to unlock position
Rear Escape release Button	Returned status	Returned status	Returned status	When operating the Button
Main Circuit 11-42 21-52	Closed	Open	Open	Open
Monitor Circuit 11-12 21-22 31-32	Closed	Closed	Open	Closed
Monitor Circuit 23-24 33-34	Open	Open	Closed	Open
Monitor Circuit 41-42 51-52	Closed	Open	Open	Open
Monitor Circuit 53-54 63-64	Open	Closed	Closed	Closed
	Door is locked. The machine can be operated.	Door is unlocked. The machine can not be operated.	The machine can not be operated.	Door is unlocked. The machine can not be operated.

• Solenoid Lock Type (HS5L-□7Y)

Door States	Closed	Closed	Open	Closed
Solenoid Power A1-A2	ON	OFF	OFF/ON *12	OFF *12 *13
Manual Unlock Key	Turn the key to lock position	Turn the key to lock position	Turn the key to lock position	Turn the key to unlock position
Rear Escape release Button	Returned status	Returned status	Returned status	When operating the Button
Main Circuit 11-42 21-52	Closed	Open	Open	Open
Monitor Circuit 11-12 21-22 31-32	Closed	Closed	Open	Closed
Monitor Circuit 23-24 33-34	Open	Open	Closed	Open
Monitor Circuit 41-42 51-52	Closed	Open	Open	Open
Monitor Circuit 53-54 63-64	Open	Closed	Closed	Closed
	Door is locked. The machine can be operated.	Door is unlocked. The machine can not be operated.	The machine can not be operated.	Door is unlocked. The machine can not be operated.

⚠ CAUTION

*12: Do not attempt manual unlocking when the solenoid is energized.
 *13: Do not energize the solenoid for a long time while the door is

⚠ CAUTION

*9: Marking is possible as this product meets the requirements of the locking monitoring section (5.7.2.2) described in article 9.2.1 of ISO14119 and the requirements of ISO13849-1 (safety-related parts of controls systems). This marking has been added to the 2013 version of ISO14119. However, this marking cannot be applied to solenoid lock type switches as they do not meet the general requirements (5.7.1) of ISO14119.

- Contact operation is based on the condition that the actuator is inserted into the center of the safety switch slot.
- Contact operation shows the HS9Z-A51 actuator.
 (For other actuators, add 1.3 mm to contact operation.)
- Use main circuit or monitor circuit with for the input to safety circuit.
- Indicator turns on when solenoid is energized.
- (Type HS5L-DD) Terminals 12-41, 22-51 are connected together internally.

6 Wiring

Terminal wiring method

Terminal NO.

<4 contact type>

21/23/ 22/24/ 31/33/ 32/34/
63 64 51/53 52/54

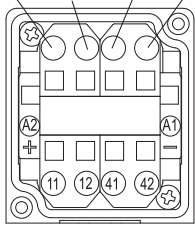

<2 contact type>

11/13/ 12/14/ 21/23/ 22/24/
51/53 52/54 41/43 42/44

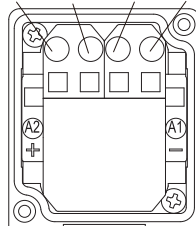

• Recommended Wire Core Size
: 0.3 to 1.5 mm² (AWG22to16)

• Wire Length inside the Safety Switch

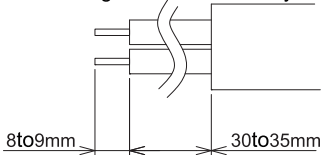

• For wiring, use the following applicable screwdriver.
(Tip shape of the driver is according to the standard of DIN5264)

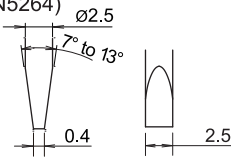

• In applications using ferrules for stranded wires, choose the ferrule listed in the table.

Applicable wire (stranded) mm ²	AWG	Part No.	Manufacturer
0.34	22	AI0.34-6TQ	Phoenix Contact
0.5	20	AI0.5-6WH	
0.75	18	AI0.75-6GY	
1	18	AI1-6RD	Nichifu
0.5	20	TE0.5-8	
0.75	18	TE0.75-8	
1	18	TE1.0-8	

• Wire insertion positions, screwdriver insertion positions, and the directions of screwdriver tip are shown below.

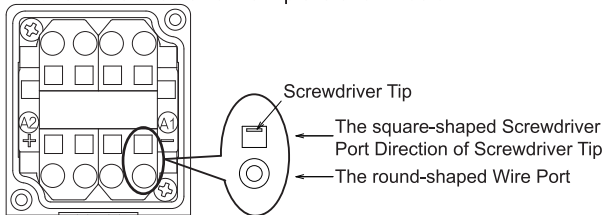

Wiring Instructions

1. Insert the applicable screwdriver into the square-shaped port as shown, until the screwdriver tip touches the bottom of the spring.
2. Push in the screwdriver until it touches the bottom of the port. The wire port is now open, and the screwdriver is held in place. The screwdriver will not come off even if you release your hand.

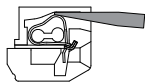

3. While the screwdriver is retained in the port, insert the wire or ferrule into the round-shaped wire port. Each wire port can accommodate one wire or ferrule.
4. Pull out the screwdriver. The connection is now complete.

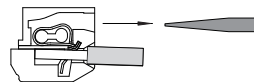
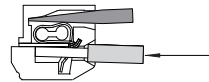

CAUTION

- When using wire with insulation diameter of $\phi 2.0$ mm or less, do not insert the wire too deep where the insulation inserts into the spring clamp opening. Otherwise conductive failure will be caused. Make sure that the wire insulation is stripped 8 to 9 mm and the wire is inserted to the bottom.
- Please only connect one wire per terminal port (according to the general requirements section (13.1.1) of IEC60204).

Incorrect

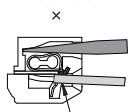

The wire insulation sheath is in contact with the clamps

Correct

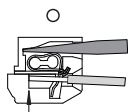

The wire is inserted deep enough between the clamps

Jumpers' mounting method (type number HS9Z-JP5L)

- Jumpers are used to connect in series door monitor circuits (11-12)/(21-22) and lock monitor circuits (41-42)/(51-52) - 4 contact type HS5L switches to a safety circuit.

For example, if you want to connect circuits no.12 and no.41 to each other:

- I: Insert a screwdriver into the square-shaped screwdriver port no.12 and no.41
- II: Insert a jumper all the way into wiring port no.12 and no.41
- III: Remove the screwdriver

Note: A, B, C, D, F, G and J type circuits are mounted and sold with jumpers connecting terminals (2-4). DD type circuits are mounted and sold with jumpers connecting terminals (2-4) and (2-5). Only connect jumpers to terminals (2-4) and (2-5).

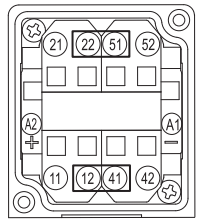

Applicable Connectors

Use a connector with a degree of protection IP67.

Applicable connector dimensions
: See the figure on the right.

When using flexible conduit and metal connector

Applicable Flexible Conduit Example:
Type VF-03 (made by Nihon Flex)

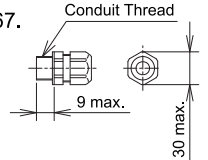

Applicable Metal Connector Example:

(M20) Type RLC-103EC20 (made by Nihon Flex)

When using plastic connector, metal connector and multi-core cable (M20) Applicable Plastic Connector Example

: Type ST-M20 x 1.5 (made by LAPP)

Applicable Metal Connector Example

: Type ALS-□□EC20 (made by Nihon Flex)

Note : Confirm the outside diameter of the multi-core cable, the connector type depends on the outside diameter of multi-core cable.

Note : When using ST-M20 x 1.5, use with gasket GP-M (Type No: GPM20, made by LAPP).

Note : If you use HS5L as Type 4X, please use M20 connectors that are certified the following.

Plastic connector: Type 4,4X, 6 or 6P

Metal connector: Type 4X or 6P

connecters' mounting method

1. Loosen connector A and connector B, and insert the cable into these pieces in the following order
: connector B → waterproof gasket → connector A.

Do not tighten the connectors yet.

2. Remove the terminal cover from the switch and insert the cable into the cover.
3. Wire the terminals.
4. Tighten connector A into the terminal cover. Fix the terminal cover back into its original position.

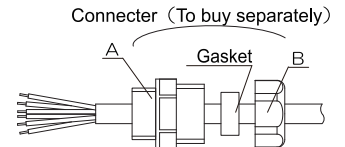

Tighten connector B.

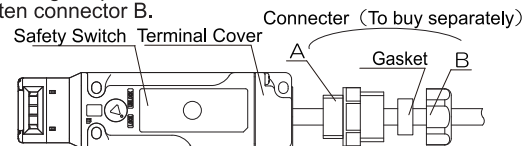

Note : To unwind the terminals, disassemble the product in the following order: turn off the power → loosen connector B → remove the terminal cover → remove the waterproof gasket from connector A* → loosen connector A

*Please remove the water-proof gasket carefully with tools such as tweezers. Be careful when removing the gasket as damages may affect its waterproof properties. Also, loosening connector A without removing the gasket first may damage the cable and provoke connection issues. Please make sure you re-insert the waterproof gasket properly into connector A when re-assembling the product.

CAUTION

- Make sure not to lose any screw when removing the terminal cover from the switch.
- Please make sure the cable is inserted deep enough into the terminal cover so that the waterproof gasket can tighten the cable sheath completely and ensure its waterproof functions.
- Make sure you always tighten connector A before connector B, otherwise the wires which connect the terminals might get twisted or might break, and this might also damage the terminal ports.
- When tightening the connectors, only use a tightening torque that is approved by the connectors' manufacturer to ensure waterproof properties of the product.
- Do not pull or twist the cable with excessive force, otherwise you might damage the wires inside of it.

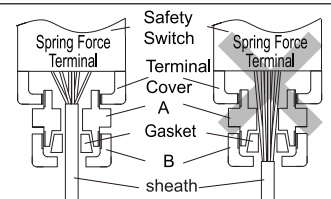

The waterproof gasket is completely tightening the cable

The waterproof gasket is not properly tightening the cable

7 Example of wiring Diagram realizing Safety Category

□ Example of wiring Diagram realizing Safety Category 3

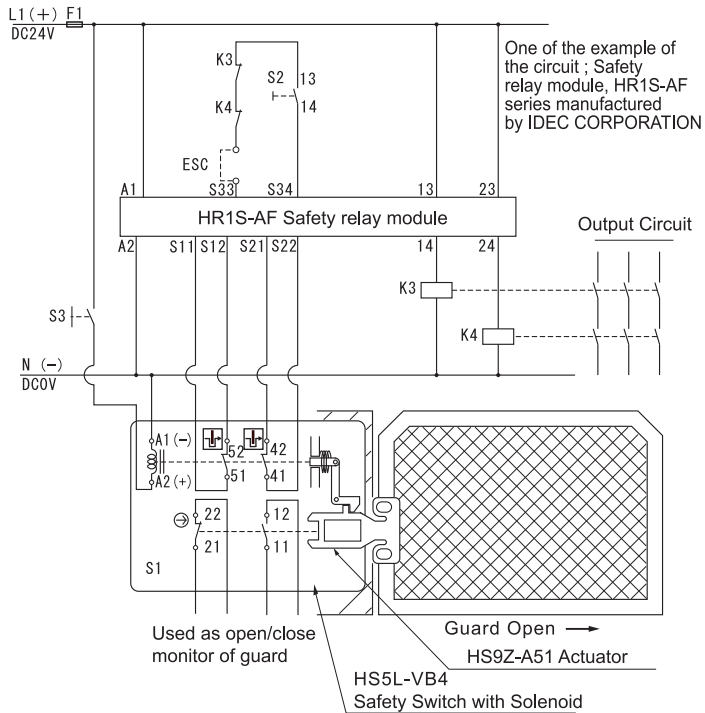

□ Example of wiring Diagram realizing Safety Category 4

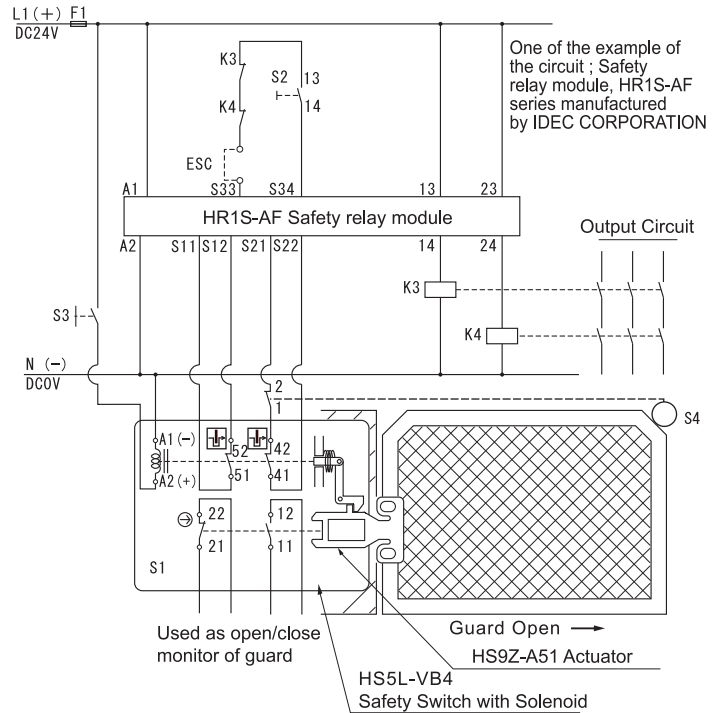

- S1: HS5L-VB4 Safety Switch with Solenoid
- S2: Starting Switch (HW Series Momentary)
- S3: Unlocking Enabling Switch
- S4: Safety limit Switch
- ESC: Outside start condition
- K3, 4: Safety Contactor
- F1: Outside fuse of safety relay module at power supply line

Note: Use the monitoring device (Safety relay module) provided the capability to detect a cross short circuit.
The insulation of the cable has to withstand environmental influences.
If a control device other than the one shown in the draft is used, the used control device has to be equipped with a cross short circuit monitor.

8 Dimensions (mm)

Safety Switch dimensions

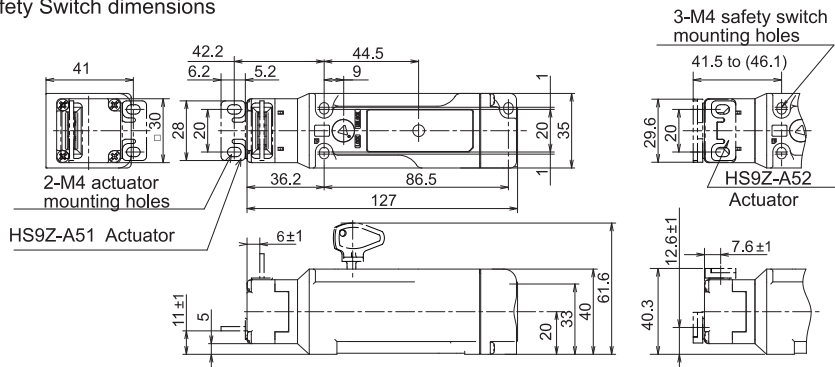

Main body mounting hole layout

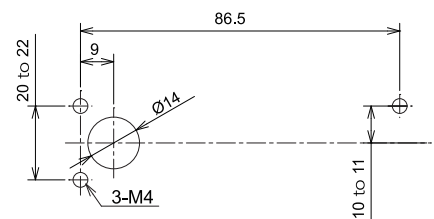

Type: HS5L-□L

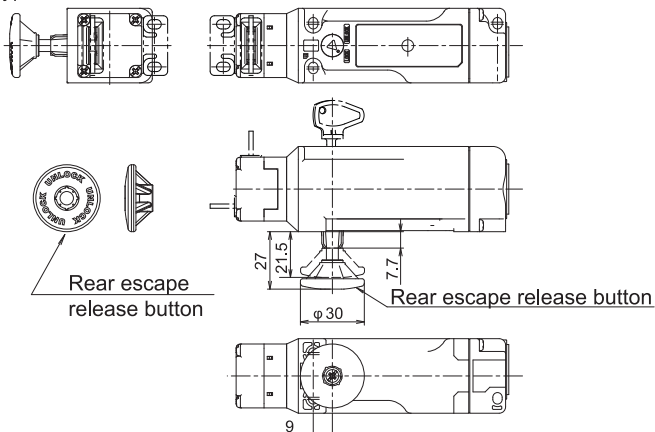

Note:
Use the attached slot plug to close the unused actuator entry slot.

Accessories dimensions
(To be sold by separately)

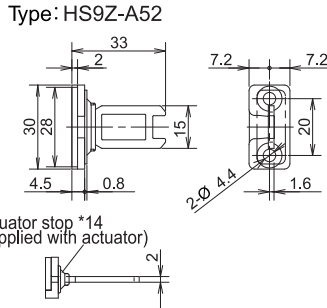
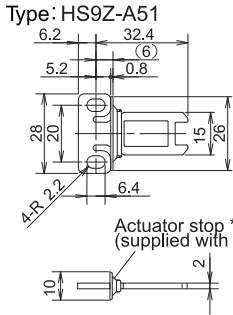

HS9Z-A51/A52 Actuator mounting hole layout

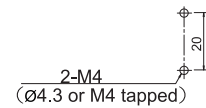

Type: HS9Z-A51A

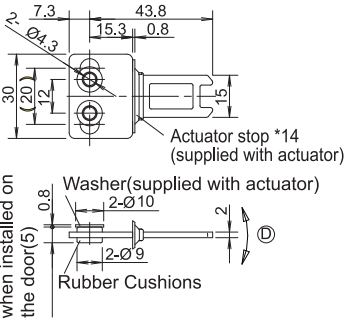

Type: HS9Z-A52A

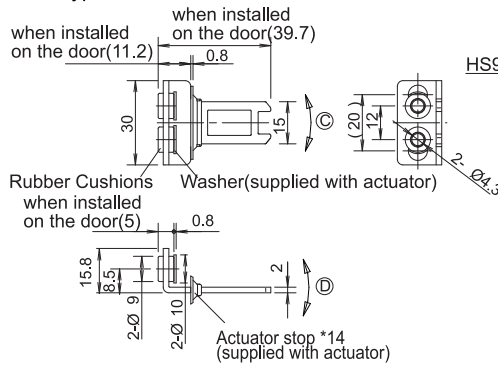

HS9Z-A51A/A52A Actuator mounting hole layout

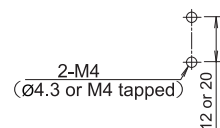

*Mounting pitch is set to 12 mm in factory.
When setting the mounting pitch to 20 mm,
widen the pitch of rubber cushions to 20 mm.
*The actuator has movement flexibility to the
directions shown in ①.

*When the mounting pitch is 12 mm (factory setting), the actuator has
movement flexibility to the directions shown in ② and ③.
*When the mounting pitch is 20 mm, the actuator has movement flexibility
to the directions shown in ④. Side the rubber cushions together with the screws.

Type: HS9Z-A55

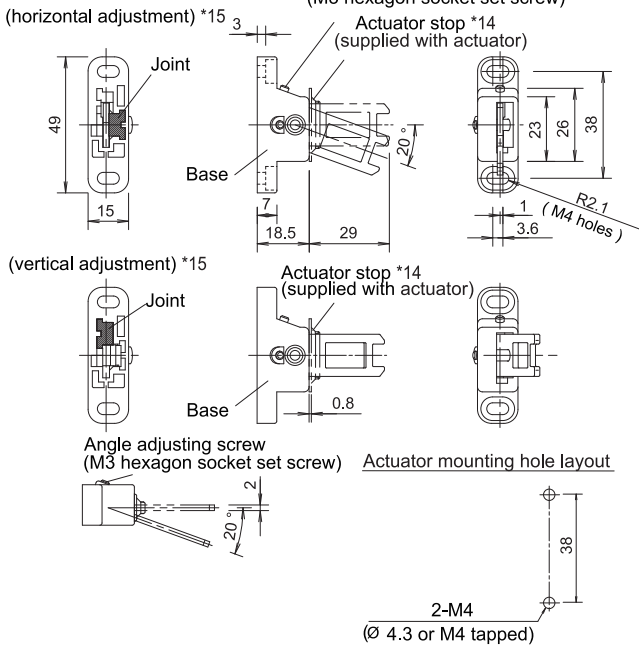

Type: HS9Z-A53

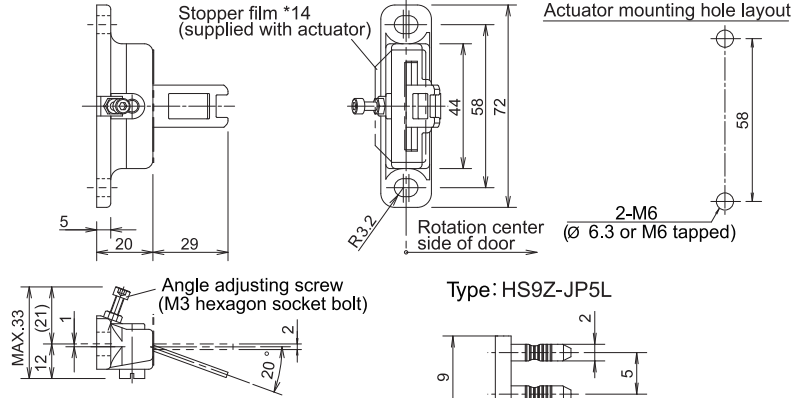

9 Precaution for Disposal

Dispose of the HS5L safety switch as an industrial waste.

IDEC CORPORATION

<http://www.idec.com>
2014.11

Manufacturer: IDEC CORP.
2-6-64 Nishimiyahara Yodogawa-ku, Osaka 532-0004, Japan
EU Authorized Representative: IDEC Elektrotechnik GmbH
Wendenstrasse 331, D-20537 Hamburg, Germany

DECLARATION OF CONFORMITY
We, IDEC CORPORATION 2-6-64, Nishimiyahara Yodogawa-ku,
Osaka 532-8550, Japan declare under our sole responsibility that the product:
Description: Safety Switch
Model No: HS5L
to which this declaration relates is in conformity with the EC Directive on
the following standard(s) or other normative document(s). In case of alteration
of the product, not agreed upon by us, this declaration will lose its validity.
Applicable EC Directive: Low Voltage Directive (2006/95/EC)
Machinery Directive (2006/42/EC)
Applicable Standard(s): EN 60947-5-1, GS-ET-19

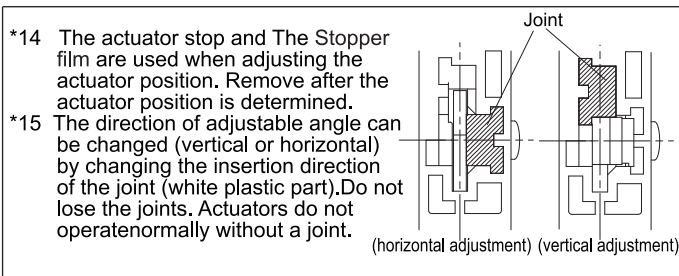

X-ON Electronics

Largest Supplier of Electrical and Electronic Components

Click to view similar products for [idec manufacturer](#):

Other Similar products are found below :

[LT7A-XE-G](#) [LT7A-XE-R](#) [LT7B-A250](#) [LT7B-A250FB](#) [LW1B-M1C6-W](#) [LW6L-M1C24MG](#) [FB1T-000Z](#) [FB1W-XW1E-BV411MR](#) [FB3W-413Z](#) [FC2A-KP1C](#) [FC4A-J8AT1](#) [FC4A-T16S3](#) [FC5A-C16R2C](#) [MM-SMART-24](#) [MM-SMART-40](#) [FT1A-C12RA-S](#) [FT1A-C12RA-W](#) [FT1A-C14SA-B](#) [PF3S-BP12](#) [PS3X-D24AFG](#) [PS3X-Q12AFG](#) [GT3A-3AD24](#) [GT3F-2EAD24](#) [GT3S-2AF20](#) [GT3W-A16AD24](#) [ABD302N-R](#) [ABD410N-R](#) [ABFD411N-G](#) [ABN4F11-G](#) [ABPD201N-R](#) [HE2B-M211PB](#) [HE2G-21SH](#) [HE9Z-D3B](#) [HG9Z-2A1](#) [HG9Z-XC300](#) [ACSNO-6123-FB-C6002](#) [RH3V2-UAC240V](#) [DFAN-031-B](#) [AL6M-LK1-G](#) [AL6M-P3-R](#) [AL6Q-M13-W](#) [AL6Q-M23P-QG](#) [ALFD29901DN-G-24V](#) [ALFN22211DNG-U](#) [ALFW224611D-W](#) [ALNE8811-G](#) [ALQW2B24611D-G](#) [ALW212611-G](#) [ALW22211DG](#) [ALW29902D-G-12V](#)