

## LB Flush Mount & 16mm Miniature Switches & Pilot Lights

Flush bezel projects only 2mm from front of panel. Standard bezel has a depth of only 27.9mm! Removable contact blocks are ideal for single board mounting.

### Key Features

- Pushbuttons, lever switches, selector switches, and key selector switches with up to 3PDT contacts.
- Key selectors with keys that are difficult to duplicate. Seven different key numbers to choose from.
- Pilot lights with flat or dome lenses.
- Buzzers with 80dB steady sound.
- Black or metallic flush bezels available.
- Bright and clear LED illuminated face.
- Choice of either gold-clad or silver contacts.
- Degree of protection: IP65 (from the front of the panel).



Applicable Standards	Mark	File No. or Organization
UL508		UL Recognition No.E55996
CSA 22.2 No.14		CSA File No. LR 21451
EN60947-5-1		TÜV Rheinland
		EU Low Voltage Directive
GB14048.5		

### Specifications

Operating Temperature	-25 to +60°C (no freezing), Illuminated units: -25 to +55°C
Storage Temperature	-30 to +80°C (no freezing)
Operating Humidity	45 to 85% RH (no condensation)
Contact Resistance	50 mW maximum (initial value)
Insulation Resistance	100 MW minimum (500V DC megger)
Dielectric Strength	Switch Between live part and ground: 2,000V AC, 1 min. Between terminals of different poles: 2,000V AC, 1 min. Between terminals of the same poles: 1,000V AC, 1 min.
	Illumination Between live part and ground: 2,000V AC, 1 min.
Vibration Resistance	Operating extremes/Damage limits: 5 to 55 Hz, amplitude 0.5mm
Shock Resistance	Operating extremes: 100 m/s <sup>2</sup> Damage limits: 1,000 m/s <sup>2</sup>
Mechanical Life (minimum operations)	Momentary: 2,000,000 Maintained: 250,000 Selector switches: 250,000 Key selector switches: 250,000
Electrical Life (minimum operations)	Momentary: 50,000 / 100,000 <sup>1</sup> Maintained: 50,000 / 100,000 <sup>2</sup> Selector switches: 50,000 / 100,000 <sup>2</sup> Key selector switches: 50,000 / 100,000 <sup>2</sup>
Degree of Protection	IP65 (IEC 60529)
Terminal Style	Solder/tab terminal #110, PC board terminal
Bezel	Black plastic or metallic
Weight (approx.)	11g (lever switch)
	13g (pilot light, pushbutton)
	14g (illuminated pushbutton, pushbutton with guard, buzzer)
	15g (selector switch, illuminated pushbutton with guard) 27g (key selector switch)

1. Switching frequency 1,800 operations/h.
2. Switching frequency 1,200 operations/h.

### Contact Ratings

Gold Contact (switch base color: blue)			
Rated Insulation Voltage	250V		
Rated Thermal Current	3A		
Rated Operating Voltage	30V DC	125V AC	
Rated Operating Current (resistive load)	0.1A	0.1A	
Contact Material	Gold-clad silver		

Minimum applicable load (reference value): 5V AC/DC, 1 mA

Silver Contact (switch base color: gray)					
Rated Insulation Voltage	250V				
Rated Operating Voltage	30V	125V	250V		
Rated Operating Current	AC 50/60Hz	Resistive load	—	5A	5A
		Inductive load	—	3A	1.5A
	DC	Resistive load	5A	1.1A	—
		Inductive load	2.5A	0.55A	—
	AC 50/60Hz	Resistive load	—	5A	3A
		Inductive load	—	3A	1.5A
DC	Resistive load	3A	0.6A	—	
	Inductive load	1A	0.22A	—	
Rated Thermal Current	5A				
Contact Material	Silver				

AC inductive load: PF=0.6 to 0.7 DC inductive load: L/R=7 ms max.

### LED Ratings

Rated Voltage	5V DC	12V AC/DC	24V AC/DC
Voltage Range	5V DC±5%	12V AC/DC±10%	24V AC/DC ±10%
LED Part No.	LB9Z-LED5②	LB9Z-LED1②	LB9Z-LED2②

Rated Current	A, R: 22 mA G, PW, S: 16 mA
Voltage Rating	Marked on the side of the LED unit

LED Life (reference value) Approx. 30,000 hours (until the brightness reduces to 50% of the initial value)

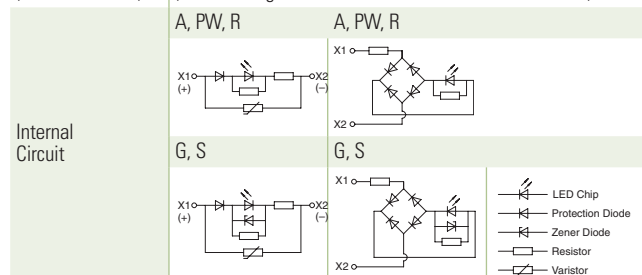

1. For ② (color code): A (amber), G (green), PW (white), R (red), S (blue)
2. Use the white LED for yellow illumination.
3. LED lamp contains a current-limiting resistor.

Illuminated Pushbuttons (Assembled)

Style	Operation	Operating Voltage	Contact	Standard Bezel		Flush Bezel		② Color Code
				Solder/Tab Terminal (silver contacts)	PC Board Terminal (gold contacts)	Solder/Tab Terminal (silver contacts)	PC Board Terminal (gold contacts)	
Standard Bezel (black)   	Momentary	5V DC	SPDT	LB⓪L-M1T51⓪	LB⓪L-M1T11V⓪	LB⓪⓪L-M1T51⓪	LB⓪⓪L-M1T11V⓪	Specify the color code in place of ② in the Part Number:  A: amber G: green R: red S: blue PW: white Y: yellow
			DPDT	LB⓪L-M1T61⓪	LB⓪L-M1T21V⓪	LB⓪⓪L-M1T61⓪	LB⓪⓪L-M1T21V⓪	
		12V AC/DC	SPDT	LB⓪L-M1T53⓪	LB⓪L-M1T13V⓪	LB⓪⓪L-M1T53⓪	LB⓪⓪L-M1T13V⓪	
			DPDT	LB⓪L-M1T63⓪	LB⓪L-M1T23V⓪	LB⓪⓪L-M1T63⓪	LB⓪⓪L-M1T23V⓪	
		24V AC/DC	SPDT	LB⓪L-M1T54⓪	LB⓪L-M1T14V⓪	LB⓪⓪L-M1T54⓪	LB⓪⓪L-M1T14V⓪	
			DPDT	LB⓪L-M1T64⓪	LB⓪L-M1T24V⓪	LB⓪⓪L-M1T64⓪	LB⓪⓪L-M1T24V⓪	
Flush Bezel (metallic or black)   	Maintained	5V DC	SPDT	LB⓪L-A1T51⓪	LB⓪L-A1T11V⓪	LB⓪⓪L-A1T51⓪	LB⓪⓪L-A1T11V⓪	
			DPDT	LB⓪L-A1T61⓪	LB⓪L-A1T21V⓪	LB⓪⓪L-A1T61⓪	LB⓪⓪L-A1T21V⓪	
		12V AC/DC	SPDT	LB⓪L-A1T53⓪	LB⓪L-A1T13V⓪	LB⓪⓪L-A1T53⓪	LB⓪⓪L-A1T13V⓪	
			DPDT	LB⓪L-A1T63⓪	LB⓪L-A1T23V⓪	LB⓪⓪L-A1T63⓪	LB⓪⓪L-A1T23V⓪	
		24V AC/DC	SPDT	LB⓪L-A1T54⓪	LB⓪L-A1T14V⓪	LB⓪⓪L-A1T54⓪	LB⓪⓪L-A1T14V⓪	
			DPDT	LB⓪L-A1T64⓪	LB⓪L-A1T24V⓪	LB⓪⓪L-A1T64⓪	LB⓪⓪L-A1T24V⓪	
Black Bezel with Guard 		24V AC/DC	SPDT	LB⓪L-A1T54⓪	LB⓪L-A1T14V⓪	LB⓪⓪L-A1T54⓪	LB⓪⓪L-A1T14V⓪	
			DPDT	LB⓪L-A1T64⓪	LB⓪L-A1T24V⓪	LB⓪⓪L-A1T64⓪	LB⓪⓪L-A1T24V⓪	

- For Standard Bezel part numbers specify:
  - Bezel shape in place of ⓪. 1 (round), 2 (square), 3 (rectangular)
  - Lens/LED color in place of ②. A (amber), G (green), PW (white), R (red), S (blue), Y (yellow)
- For Flush Bezel part numbers specify:
  - Lens/LED in place of ②. A (amber), G (green), PW (white), R (red), S (blue), Y (yellow)
  - Bezel shape in place of ③. 6 (round), 7 (square), 8 (rectangular)
  - Bezel material in place of ④. M (metallic), Blank (black), G (black with guard)
- Solder/Tab terminals have silver contacts and PC Board Terminals have gold contacts.
- Illuminated pushbuttons contain an LED unit.
- See page 524 for dimensions.
- See page 539 for replacement LED units.
- Illuminated pushbuttons can be used with legend markings. Engraving can be done on a marking plate which is placed in the lens, or a clear film can be printed and placed in the lens. See page 539 for details on the marking plate and film.

Switches & Pilot Devices

Signaling Lights

Relays & Sockets

Timers

Contactors

Terminal Blocks

Circuit Breakers

**Illuminated Pushbuttons (Sub-assembled)**

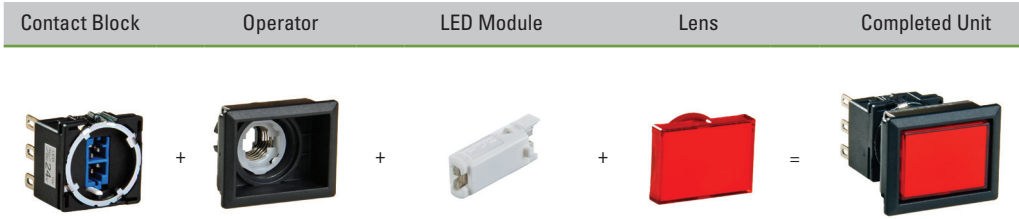

**Contact Block**

Terminal Style	Material	Contact	Part Number
	Silver	SPDT	LB-T50
		DPDT	LB-T60
	Gold	SPDT	LB-T10V
		DPDT	LB-T20V

**LED Module**

Style	Color	Voltage	Part Number
	Amber	5V	LB9Z-LED5A
		12V	LB9Z-LED1A
		24V	LB9Z-LED2A
	Green	5V	LB9Z-LED5G
		12V	LB9Z-LED1G
		24V	LB9Z-LED2G
	Red	5V	LB9Z-LED5R
		12V	LB9Z-LED1R
		24V	LB9Z-LED2R
	Blue	5V	LB9Z-LED5S
		12V	LB9Z-LED1S
		24V	LB9Z-LED2S
	White	5V	LB9Z-LED5PW
		12V	LB9Z-LED1PW
		24V	LB9Z-LED2PW
	Yellow	5V	LB9Z-LED5PW
		12V	LB9Z-LED1PW
		24V	LB9Z-LED2PW

**Operator**

Style	Mounting Style	Shape	Monmontary	Maintained
	Standard (Plastic)	Round	LB1L-M0	LB1L-A0
		Square	LB2L-M0	LB2L-A0
		Rectangular	LB3L-M0	LB3L-A0
	Flush Mount (Plastic)	Round	LB6L-M0	LB6L-A0
		Square	LB7L-M0	LB7L-A0
		Rectangular	LB8L-M0	LB8L-A0
	Flush Mount (Metallic)	Round	LB6ML-M0	LB6ML-A0
		Square	LB7ML-M0	LB7ML-A0
		Rectangular	LB8ML-M0	LB8ML-A0
	Flush Mount (Built-in switch guard)	Round	LB6GL-M0	LB6GL-A0
		Square	LB7GL-M0	LB7GL-A0
		Rectangular	LB8GL-M0	LB8GL-A0

**Lens**

Shape	Color	Part Number
	Amber	LB1A-L1A
	Green	LB1A-L1G
	Red	LB1A-L1R
	Blue	LB1A-L1S
	White	LB1A-L1W
	Yellow	LB1A-L1Y
	Amber	LB2A-L1A
	Green	LB2A-L1G
	Red	LB2A-L1R
	Blue	LB2A-L1S
	White	LB2A-L1W
	Yellow	LB2A-L1Y
	Amber	LB3A-L1A
	Green	LB3A-L1G
	Red	LB3A-L1R
	Blue	LB3A-L1S
	White	LB3A-L1W
	Yellow	LB3A-L1Y

Pilot Lights (Assembled)

Style	Operating Voltage	Standard Bezel		Flush Bezel		② Color Code							
		Solder/Tab Terminal (silver contacts)	PC Board Terminal (gold contacts)	Solder/Tab Terminal (silver contacts)	PC Board Terminal (gold contacts)								
Standard Bezel (black)    	5V DC	LB⓪P-⓪T01⓪	LB⓪P-⓪T01V⓪	LB⓪⓪P-⓪T01⓪	LB⓪⓪P-⓪T01V⓪								
							Flush Bezel (metallic or black)    	12V AC/DC	LB⓪P-⓪T03⓪	LB⓪P-⓪T03V⓪	LB⓪⓪P-⓪T03⓪	LB⓪⓪P-⓪T03V⓪	Specify the color code in place of ② in the Part Number:  A: amber G: green PW: white R: red S: blue Y: yellow

- For Standard Bezel part numbers specify:
  - bezel shape in place of ⓪. 1 (round), 2 (square), 3 (rectangular)
  - lens/LED color in place of ②. A (amber), G (green), PW (white), R (red), S (blue), Y (yellow)
  - lens type code in place of ⓪. 1 (flat), 2 (dome with round lens)
- For Flush Bezel part numbers specify:
  - lens/LED in place of ②. A (amber), G (green), PW (white), R (red), S (blue), Y (yellow)
  - bezel shape in place of ⓪. 6 (round), 7 (square), 8 (rectangular)
  - bezel material in place of ⓪. M (metallic), Blank (black)
  - lens type code in place of ⓪. 1 (flat), 2 (dome with round lens)
- Pilot lights contain an LED unit.
- See page page 524 for dimensions.
- See page page 539 for replacement LED unit.

Pilot Lights (Sub-assembled)

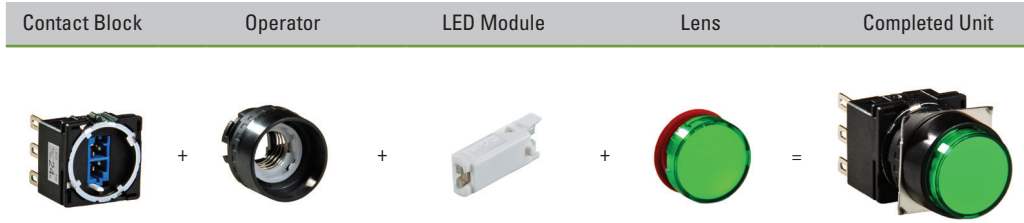

Contact Block

Terminal Style	Part Number	
	Solder Tab	LB-T00
	PCB	LB-T00V

LED Module

Style	Color	Voltage	Part Number
	Amber	5V	LB9Z-LED5A
		12V	LB9Z-LED1A
		24V	LB9Z-LED2A
Green	5V	LB9Z-LED5G	
	12V	LB9Z-LED1G	
	24V	LB9Z-LED2G	
Red	5V	LB9Z-LED5R	
	12V	LB9Z-LED1R	
	24V	LB9Z-LED2R	
Blue	5V	LB9Z-LED5S	
	12V	LB9Z-LED1S	
	24V	LB9Z-LED2S	
White	5V	LB9Z-LED5PW	
	12V	LB9Z-LED1PW	
	24V	LB9Z-LED2PW	
Yellow	5V	LB9Z-LED5PW	
	12V	LB9Z-LED1PW	
		24V	LB9Z-LED2PW

Operator

Style	Mounting Style	Shape	Part Number
	Standard (Plastic)	Round	LB1P-0
		Square	LB2P-0
		Rectangular	LB3P-0
	Flush Mount (Plastic)	Round	LB6P-0
		Square	LB7P-0
		Rectangular	LB8P-0
	Flush Mount (Metallic)	Round	LB6MP-0
		Square	LB7MP-0
		Rectangular	LB8MP-0

Lens

Shape	Color	Part Number
Round 	Amber	LB1A-P1A
	Green	LB1A-P1G
	Red	LB1A-P1R
	Blue	LB1A-P1S
	White	LB1A-P1W
	Yellow	LB1A-P1Y
Dome 	Amber	LB1A-P2A
	Green	LB1A-P2G
	Red	LB1A-P2R
	Blue	LB1A-P2S
	White	LB1A-P2W
	Yellow	LB1A-P2Y
Square 	Amber	LB2A-P1A
	Green	LB2A-P1G
	Red	LB2A-P1R
	Blue	LB2A-P1S
	White	LB2A-P1W
	Yellow	LB2A-P1Y
Rectangular 	Amber	LB3A-P1A
	Green	LB3A-P1G
	Red	LB3A-P1R
	Blue	LB3A-P1S
	White	LB3A-P1W
	Yellow	LB3A-P1Y

Non-Illuminated Pushbuttons (Assembled)

Style	Operation	Contact	Standard Bezel		Flush Bezel		Ⓢ Color Code
			Solder/Tab Terminal (silver contacts)	PC Board Terminal (gold contacts)	Solder/Tab Terminal (silver contacts)	PC Board Terminal (gold contacts)	
Standard Bezel (black)   	Momentary	SPDT	LBⓈB-M1T5Ⓢ	LBⓈB-M1T1VⓈ	LBⓈⓈB-M1T5Ⓢ	LBⓈⓈB-M1T1VⓈ	Specify the color code in place of Ⓢ in the Part Number:  B: black G: green R: red S: blue W: white Y: yellow
		DPDT	LBⓈB-M1T6Ⓢ	LBⓈB-M1T2VⓈ	LBⓈⓈB-M1T6Ⓢ	LBⓈⓈB-M1T2VⓈ	
		3PDT	LBⓈB-M1T7Ⓢ	LBⓈB-M1T3VⓈ	LBⓈⓈB-M1T7Ⓢ	LBⓈⓈB-M1T3VⓈ	
Flush Bezel (metallic or black)   	Maintained	SPDT	LBⓈB-A1T5Ⓢ	LBⓈB-A1T1VⓈ	LBⓈⓈB-A1T5Ⓢ	LBⓈⓈB-A1T1VⓈ	
		DPDT	LBⓈB-A1T6Ⓢ	LBⓈB-A1T2VⓈ	LBⓈⓈB-A1T6Ⓢ	LBⓈⓈB-A1T2VⓈ	
		3PDT	LBⓈB-A1T7Ⓢ	LBⓈB-A1T3VⓈ	LBⓈⓈB-A1T7Ⓢ	LBⓈⓈB-A1T3VⓈ	
Black Bezel with Guard 		3PDT	LBⓈB-A1T7Ⓢ	LBⓈB-A1T3VⓈ	LBⓈⓈB-A1T7Ⓢ	LBⓈⓈB-A1T3VⓈ	

- For Standard Bezel part numbers specify:
  - bezel shape in place of Ⓢ. 1 (round), 2 (square), 3 (rectangular)
  - lens/LED in place of Ⓢ. B (black), G (green), R (red), S (blue), W (white), Y (yellow)
- For Flush Bezel part numbers specify:
  - lens/LED in place of Ⓢ. B (black), G (green), R (red), S (blue), W (white), Y (yellow)
  - bezel shape in place of Ⓢ. 6 (round), 7 (square), 8 (rectangular)
  - bezel material in place of Ⓢ. M (metallic), Blank (black)
- See page 526 for dimensions.
- Lens can be used with legend markings. Engraving can be done on a marking plate which is placed into the lens, or a clear film can be printed and placed under the lens. For details on the marking plate and film, see page 539.

Switches & Pilot Devices

Signaling Lights

Relays & Sockets

Timers

Contactors

Terminal Blocks

Circuit Breakers

**Non-Illuminated Pushbuttons (Sub-assembled)**

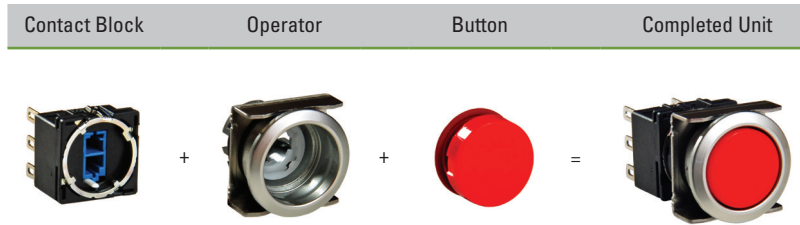

**Contact Block**

Terminal Style	Material	Contact	Part Number	
	Solder/Tab	Silver	SPDT	LB-T5
			DPDT	LB-T6
			3PDT	LB-T7
	PCB	Gold	SPDT	LB-T1V
			DPDT	LB-T2V
			3PDT	LB-T3V









**Operator**

Style	Mounting style	Shape	Momentary	Maintained
	Standard (Plastic)	Round	LB1L-M0	LB1L-A0
		Square	LB2L-M0	LB2L-A0
		Rectangular	LB3L-M0	LB3L-A0
	Flush Mount (Plastic)	Round	LB6L-M0	LB6L-A0
		Square	LB7L-M0	LB7L-A0
		Rectangular	LB8L-M0	LB8L-A0
	Flush Mount (Metallic)	Round	LB6ML-M0	LB6ML-A0
		Square	LB7ML-M0	LB7ML-A0
		Rectangular	LB8ML-M0	LB8ML-A0
	Flush Mount (Built-in switch guard)	Round	LB6GL-M0	LB6GL-A0
		Square	LB7GL-M0	LB7GL-A0
		Rectangular	LB8GL-M0	LB8GL-A0

**Button**

Style	Color	Part Number
	Round	
	Black	LB1A-B1B
	Green	LB1A-B1G
	Red	LB1A-B1R
	Blue	LB1A-B1S
	White	LB1A-B1W
	Black	LB2A-B1B
	Green	LB2A-B1G
	Red	LB2A-B1R
	Blue	LB2A-B1S
	White	LB2A-B1W
	Yellow	LB2A-B1Y
	Black	LB3A-B1B
	Green	LB3A-B1G
	Red	LB3A-B1R
	Blue	LB3A-B1S
	White	LB3A-B1W
	Yellow	LB3A-B1Y

Selector Switches (Assembled)

Style	Operator Position	Contact	Standard Bezel		Flush Bezel		
			Solder/Tab Terminal (silver contacts)	PC Board Terminal (gold contacts)	Solder/Tab Terminal (silver contacts)	PC Board Terminal (gold contacts)	
Standard Bezel (black) 	90° 2-position	Maintained 	SPDT	LB⓪S-2⓪T5	LB⓪S-2⓪T1V	LB⓪S-2⓪T5	LB⓪S-2⓪T1V
		DPDT	LB⓪S-2⓪T6	LB⓪S-2⓪T2V	LB⓪S-2⓪T6	LB⓪S-2⓪T2V	
		3PDT	LB⓪S-2⓪T7	LB⓪S-2⓪T3V	LB⓪S-2⓪T7	LB⓪S-2⓪T3V	
		Spring return from right 	SPDT	LB⓪S-21⓪T5	LB⓪S-21⓪T1V	LB⓪S-21⓪T5	LB⓪S-21⓪T1V
		DPDT	LB⓪S-21⓪T6	LB⓪S-21⓪T2V	LB⓪S-21⓪T6	LB⓪S-21⓪T2V	
		3PDT	LB⓪S-21⓪T7	LB⓪S-21⓪T3V	LB⓪S-21⓪T7	LB⓪S-21⓪T3V	
	45° 3-position	Maintained 	DPDT	LB⓪S-3⓪T6	LB⓪S-3⓪T2V	LB⓪S-3⓪T6	LB⓪S-3⓪T2V
		3PDT	LB⓪S-3⓪T7	LB⓪S-3⓪T3V	LB⓪S-3⓪T7	LB⓪S-3⓪T3V	
		Spring return from right 	DPDT	LB⓪S-31⓪T6	LB⓪S-31⓪T2V	LB⓪S-31⓪T6	LB⓪S-31⓪T2V
3PDT		LB⓪S-31⓪T7	LB⓪S-31⓪T3V	LB⓪S-31⓪T7	LB⓪S-31⓪T3V		
Spring return from left 		DPDT	LB⓪S-32⓪T6	LB⓪S-32⓪T2V	LB⓪S-32⓪T6	LB⓪S-32⓪T2V	
3PDT		LB⓪S-32⓪T7	LB⓪S-32⓪T3V	LB⓪S-32⓪T7	LB⓪S-32⓪T3V		
Flush Bezel (metallic or black) 	Spring return two-way 	DPDT	LB⓪S-33⓪T6	LB⓪S-33⓪T2V	LB⓪S-33⓪T6	LB⓪S-33⓪T2V	
		3PDT	LB⓪S-33⓪T7	LB⓪S-33⓪T3V	LB⓪S-33⓪T7	LB⓪S-33⓪T3V	

Knob models shown above unless otherwise indicated.

- For Standard Bezel part numbers specify:
  - bezel shape in place of ⓪. 1 (round), 2 (square), 3 (rectangular)
  - operator shape in place of ⓪. blank (knob), L (lever).
- For Flush Bezel part numbers specify:
  - bezel shape in place of ⓪. 6 (round), 7 (square), 8 (rectangular)
  - bezel material in place of ⓪. M (metallic), Blank (black)
  - operator shape in place of ⓪. blank (knob), L (lever).
- See page page 522 for contact operation .
- See page page 528 for dimensions.

Switches & Pilot Devices

Signaling Lights

Relays & Sockets

Timers

Contactors

Terminal Blocks

Circuit Breakers



Selector Switches (Sub-assembled)



Contact Block

Terminal Style	Material	Contact	Part Number
	Solder/Tab	Silver	SPDT LB-T5
			DPDT LB-T6
			3PDT LB-T7
	PCB	Gold	SPDT LB-T1V
			DPDT LB-T2V
			3PDT LB-T3V

SPDT contacts applicable for 2-position switches only.

Operator

Style	Shape	Position	Function	Part Number		
				Knob	Lever	
Standard (Plastic)	Round	2	Maintained	LB1S-2Y	LB1S-2L	
			Spring from right	LB1S-21Y	LB1S-21L	
		3	Maintained	LB1S-3Y	LB1S-3L	
			Spring from right	LB1S-31Y	LB1S-31L	
			Spring from left	LB1S-32Y	LB1S-32L	
			Spring from both	LB1S-33Y	LB1S-33L	
	Rectangular	Square	2	Maintained	LB2S-2Y	LB2S-2L
				Spring from right	LB2S-21Y	LB2S-21L
			3	Maintained	LB2S-3Y	LB2S-3L
		Spring from right		LB2S-31Y	LB2S-31L	
		Spring from left		LB2S-32Y	LB2S-32L	
		Rectangular	2	Maintained	LB3S-2Y	LB3S-2L
				Spring from right	LB3S-21Y	LB3S-21L
				3	Maintained	LB3S-3Y
			Spring from right		LB3S-31Y	LB3S-31L
Spring from left	LB3S-32Y		LB3S-32L			
Spring from both	LB3S-33Y		LB3S-33L			

Style	Shape	Position	Function	Part Number	
				Knob	Lever
Flush Mount (Plastic)	Round	2	Maintained	LB6S-2Y	LB6S-2L
			Spring from right	LB6S-21Y	LB6S-21L
		3	Maintained	LB6S-3Y	LB6S-3L
			Spring from right	LB6S-31Y	LB6S-31L
			Spring from left	LB6S-32Y	LB6S-32L
			Spring from both	LB6S-33Y	LB6S-33L
Round	Square	2	Maintained	LB7S-2Y	LB7S-2L
			Spring from right	LB7S-21Y	LB7S-21L
		3	Maintained	LB7S-3Y	LB7S-3L
			Spring from right	LB7S-31Y	LB7S-31L
			Spring from left	LB7S-32Y	LB7S-32L
			Spring from both	LB7S-33Y	LB7S-33L
Rectangular	Round	2	Maintained	LB8S-2Y	LB8S-2L
			Spring from right	LB8S-21Y	LB8S-21L
		3	Maintained	LB8S-3Y	LB8S-3L
			Spring from right	LB8S-31Y	LB8S-31L
			Spring from left	LB8S-32Y	LB8S-32L
			Spring from both	LB8S-33Y	LB8S-33L
	Square	2	Maintained	LB6MS-2Y	LB6MS-2L
			Spring from right	LB6MS-21Y	LB6MS-21L
			3	Maintained	LB6MS-3Y
		Spring from right		LB6MS-31Y	LB6MS-31L
		Spring from left		LB6MS-32Y	LB6MS-32L
		Round	2	Maintained	LB7MS-2Y
Spring from right	LB7MS-21Y			LB7MS-21L	
3	Maintained			LB7MS-3Y	LB7MS-3L
	Spring from right		LB7MS-31Y	LB7MS-31L	
	Spring from left		LB7MS-32Y	LB7MS-32L	
Spring from both	LB7MS-33Y		LB7MS-33L		
Square	2	Maintained	LB8MS-2Y	LB8MS-2L	
		Spring from right	LB8MS-21Y	LB8MS-21L	
		3	Maintained	LB8MS-3Y	LB8MS-3L
	Spring from right		LB8MS-31Y	LB8MS-31L	
	Spring from left		LB8MS-32Y	LB8MS-32L	
	Spring from both	LB8MS-33Y	LB8MS-33L		

**Illuminated Selector Switches (Assembled)**

Style	Operating Voltage	Operator Position	Contact	Standard Bezel		Flush Bezel			
				Solder/Tab Terminal (silver contacts)	PC Board Terminal (gold contacts)	Solder/Tab Terminal (silver contacts)	PC Board Terminal (gold contacts)		
Standard Bezel (black)    Flush Bezel (metallic or black)  	5V DC	90° 2-position	Maintained L R	SPDT	LB⓪F-2T51⓪	LB⓪F-2T11V⓪	LB6⓪F-2T51⓪	LB6⓪F-2T11V⓪	
				DPDT	LB⓪F-2T61⓪	LB⓪F-2T21V⓪	LB6⓪F-2T61⓪	LB6⓪F-2T21V⓪	
	12V AC/DC	90° 2-position	Maintained L R		DPDT	LB⓪F-3T61⓪	LB⓪F-3T21V⓪	LB6⓪F-3T61⓪	LB6⓪F-3T21V⓪
					SPDT	LB⓪F-2T53⓪	LB⓪F-2T13V⓪	LB6⓪F-2T53⓪	LB6⓪F-2T13V⓪
	24V AC/DC	90° 2-position	Maintained L R		DPDT	LB⓪F-2T63⓪	LB⓪F-2T23V⓪	LB6⓪F-2T63⓪	LB6⓪F-2T23V⓪
					DPDT	LB⓪F-3T63⓪	LB⓪F-3T23V⓪	LB6⓪F-3T63⓪	LB6⓪F-3T23V⓪
45° 3-position		Maintained L C R	DPDT	LB⓪F-2T54⓪	LB⓪F-2T14V⓪	LB6⓪F-2T54⓪	LB6⓪F-2T14V⓪		
	90° 2-position	Maintained L R		DPDT	LB⓪F-2T64⓪	LB⓪F-2T24V⓪	LB6⓪F-2T64⓪	LB6⓪F-2T24V⓪	
45° 3-position			Maintained L C R	DPDT	LB⓪F-3T64⓪	LB⓪F-3T24V⓪	LB6⓪F-3T64⓪	LB6⓪F-3T24V⓪	

Flush bezel only available with round operator.

9. For Standard Bezel part numbers specify:
  - bezel shape in place of ⓪. 1 (round), 2 (square), 3 (rectangular)
  - color code in place of ⓪. A (amber), G (green), R (red), S (blue), PW (white), Y (yellow)
10. For Flush Bezel part numbers specify:
  - color code in place of ⓪. A (amber), G (green), R (red), S (blue), PW (white), Y (yellow)
  - bezel material in place of ⓪. M (metallic), Blank (black)
11. See page page 522 for contact operation.
12. See page page 530 for dimensions.

Illuminated Selector Switches (Sub-assembled)

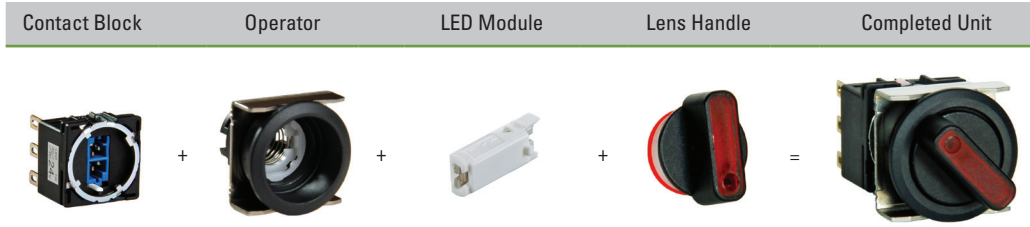

Contact Block

Terminal Style	Material	Contact	Part Number
	Silver	SPDT	LB-T50
		DPDT	LB-T60
	Gold	SPDT	LB-T10
		DPDT	LB-T20
	Gold	SPDT	LB-T10V
		DPDT	LB-T20V

SPDT contacts applicable for 2-position switches only.

Operator

Style	Shape	Position	Function	Part Number
	Round	2	Maintained	LB1F-2
		3	Maintained	LB1F-3
	Square	2	Maintained	LB2F-2
		3	Maintained	LB2F-3
	Rectangular	2	Maintained	LB3F-2
		3	Maintained	LB3F-3
	Round	2	Maintained	LB6F-2
		3	Maintained	LB6F-3
	Round	2	Maintained	LB6MF-2
		3	Maintained	LB6MF-3

LED Module

Style	Color	Voltage	Part Number
	Amber	5V	LB9Z-LED5A
		12V	LB9Z-LED1A
		24V	LB9Z-LED2A
Green	5V	LB9Z-LED5G	
	12V	LB9Z-LED1G	
	24V	LB9Z-LED2G	
Red	5V	LB9Z-LED5R	
	12V	LB9Z-LED1R	
	24V	LB9Z-LED2R	
Blue	5V	LB9Z-LED5S	
	12V	LB9Z-LED1S	
	24V	LB9Z-LED2S	
White	5V	LB9Z-LED5PW	
	12V	LB9Z-LED1PW	
	24V	LB9Z-LED2PW	
Yellow	5V	LB9Z-LED5PY	
	12V	LB9Z-LED1PY	
	24V	LB9Z-LED2PY	

Lens Handle

Style	Color	Part Number
	Amber	LA1A-FA
	Green	LA1A-FG
	Red	LA1A-FR
	Blue	LA1A-FS
	White	LA1A-FW
	Yellow	LA1A-FY

Key Selector Switches (Assembled)

Style	Operator Position	Key retained at ●	Contact	Standard Bezel		Flush Bezel		
				Solder/Tab Terminal (silver contacts)	PC Board Terminal (gold contacts)	Solder/Tab Terminal (silver contacts)	PC Board Terminal (gold contacts)	
Standard Bezel (black) 	90° Z-position	Maintained	A 	SPDT	LB⓪K-2T5A	LB⓪K-2T1VA	LB⓪⓪K-2T5A	LB⓪⓪K-2T1VA
				DPDT	LB⓪K-2T6A	LB⓪K-2T2VA	LB⓪⓪K-2T6A	LB⓪⓪K-2T2VA
				3PDT	LB⓪K-2T7A	LB⓪K-2T3VA	LB⓪⓪K-2T7A	LB⓪⓪K-2T3VA
			B 	SPDT	LB⓪K-2T5B	LB⓪K-2T1VB	LB⓪⓪K-2T5B	LB⓪⓪K-2T1VB
				DPDT	LB⓪K-2T6B	LB⓪K-2T2VB	LB⓪⓪K-2T6B	LB⓪⓪K-2T2VB
				3PDT	LB⓪K-2T7B	LB⓪K-2T3VB	LB⓪⓪K-2T7B	LB⓪⓪K-2T3VB
	Spring return from right	C 	B 	SPDT	LB⓪K-2T5C	LB⓪K-2T1VC	LB⓪⓪K-2T5C	LB⓪⓪K-2T1VC
				DPDT	LB⓪K-2T6C	LB⓪K-2T2VC	LB⓪⓪K-2T6C	LB⓪⓪K-2T2VC
				3PDT	LB⓪K-2T7C	LB⓪K-2T3VC	LB⓪⓪K-2T7C	LB⓪⓪K-2T3VC
			B 	SPDT	LB⓪K-21T5B	LB⓪K-21T1VB	LB⓪⓪K-21T5B	LB⓪⓪K-21T1VB
				DPDT	LB⓪K-21T6B	LB⓪K-21T2VB	LB⓪⓪K-21T6B	LB⓪⓪K-21T2VB
				3PDT	LB⓪K-21T7B	LB⓪K-21T3VB	LB⓪⓪K-21T7B	LB⓪⓪K-21T3VB
Flush Bezel (metallic or black) 	45° 3-position	Maintained	A 	DPDT	LB⓪K-3T6A	LB⓪K-3T2VA	LB⓪⓪K-3T6A	LB⓪⓪K-3T2VA
				3PDT	LB⓪K-3T7A	LB⓪K-3T3VA	LB⓪⓪K-3T7A	LB⓪⓪K-3T3VA
			B 	DPDT	LB⓪K-3T6B	LB⓪K-3T2VB	LB⓪⓪K-3T6B	LB⓪⓪K-3T2VB
				3PDT	LB⓪K-3T7B	LB⓪K-3T3VB	LB⓪⓪K-3T7B	LB⓪⓪K-3T3VB
			C 	DPDT	LB⓪K-3T6C	LB⓪K-3T2VC	LB⓪⓪K-3T6C	LB⓪⓪K-3T2VC
				3PDT	LB⓪K-3T7C	LB⓪K-3T3VC	LB⓪⓪K-3T7C	LB⓪⓪K-3T3VC
			D 	DPDT	LB⓪K-3T6D	LB⓪K-3T2VD	LB⓪⓪K-3T6D	LB⓪⓪K-3T2VD
				3PDT	LB⓪K-3T7D	LB⓪K-3T3VD	LB⓪⓪K-3T7D	LB⓪⓪K-3T3VD
			E 	DPDT	LB⓪K-3T6E	LB⓪K-3T2VE	LB⓪⓪K-3T6E	LB⓪⓪K-3T2VE
				3PDT	LB⓪K-3T7E	LB⓪K-3T3VE	LB⓪⓪K-3T7E	LB⓪⓪K-3T3VE
			G 	DPDT	LB⓪K-3T6G	LB⓪K-3T2VG	LB⓪⓪K-3T6G	LB⓪⓪K-3T2VG
				3PDT	LB⓪K-3T7G	LB⓪K-3T3VG	LB⓪⓪K-3T7G	LB⓪⓪K-3T3VG
			H 	DPDT	LB⓪K-3T6H	LB⓪K-3T2VH	LB⓪⓪K-3T6H	LB⓪⓪K-3T2VH
				3PDT	LB⓪K-3T7H	LB⓪K-3T3VH	LB⓪⓪K-3T7H	LB⓪⓪K-3T3VH

Assembled Key Selector Switches can't on next page.

Assembled Key Selector Switches con't on next page.

Style	Operator Position	Key retained at ●	Contact	Standard Bezel		Flush Bezel			
				Solder/Tab Terminal (silver contacts)	PC Board Terminal (gold contacts)	Solder/Tab Terminal (silver contacts)	PC Board Terminal (gold contacts)		
Standard Bezel (black)    Flush Bezel (metallic or black)  	45° 3-position	Spring return from right	B		DPDT	LB⓪K-31T6B	LB⓪K-31T2VB	LB⓪⓪K-31T6B	LB⓪⓪K-31T2VB
				3PDT	LB⓪K-31T7B	LB⓪K-31T3VB	LB⓪⓪K-31T7B	LB⓪⓪K-31T3VB	
			D		DPDT	LB⓪K-31T6D	LB⓪K-31T2VD	LB⓪⓪K-31T6D	LB⓪⓪K-31T2VD
				3PDT	LB⓪K-31T7D	LB⓪K-31T3VD	LB⓪⓪K-31T7D	LB⓪⓪K-31T3VD	
			G		DPDT	LB⓪K-31T6G	LB⓪K-31T2VG	LB⓪⓪K-31T6G	LB⓪⓪K-31T2VG
				3PDT	LB⓪K-31T7G	LB⓪K-31T3VG	LB⓪⓪K-31T7G	LB⓪⓪K-31T3VG	
		Spring return from left	C		DPDT	LB⓪K-32T6C	LB⓪K-32T2VC	LB⓪⓪K-32T6C	LB⓪⓪K-32T2VC
				3PDT	LB⓪K-32T7C	LB⓪K-32T3VC	LB⓪⓪K-32T7C	LB⓪⓪K-32T3VC	
			D		DPDT	LB⓪K-32T6D	LB⓪K-32T2VD	LB⓪⓪K-32T6D	LB⓪⓪K-32T2VD
				3PDT	LB⓪K-32T7D	LB⓪K-32T3VD	LB⓪⓪K-32T7D	LB⓪⓪K-32T3VD	
			H		DPDT	LB⓪K-32T6H	LB⓪K-32T2VH	LB⓪⓪K-32T6H	LB⓪⓪K-32T2VH
				3PDT	LB⓪K-32T7H	LB⓪K-32T3VH	LB⓪⓪K-32T7H	LB⓪⓪K-32T3VH	
Spring return two-way	D		DPDT	LB⓪K-33T6D	LB⓪K-33T2VD	LB⓪⓪K-33T6D	LB⓪⓪K-33T2VD		
		3PDT	LB⓪K-33T7D	LB⓪K-33T3VD	LB⓪⓪K-33T7D	LB⓪⓪K-33T3VD			

13. Key is retained at ● and removable at ○ positions.

14. Two keys are supplied.

15. For Standard Bezel part numbers specify bezel shape in place of ⓪. 1 (round), 2 (square), 3 (rectangular)

16. For Flush Bezel part numbers specify:

- bezel shape in place of ⓪. 6 (round), 7 (square), 8 (rectangular)

- bezel material in place of ⓪. M (metallic), Blank (black)

17. See page page 522 for contact operation.

18. See page page 531 for dimensions.

19. For additional security, wave keys also available.

Add the letter "S" before the "T" in the part no. Example: LB1K-31ST1A

Besides the standard wave key (key number 0H), six other keys are available.

To order other keys, specify the key number as shown below:

Example: LB1K-31ST2B-1H (Key number is indicated on the key cylinder. Standard keys do not have a key number indication.)

↑ (blank): Standard wave key (0H)

1H to 2H: Reversible wave key

3H to 6H: Non-reversible wave key

20. If ordering standard wave key (0H), subcomponents are available, see next page.

21. If ordering other than standard wave key (for example, key number 6H), only completed switches are available.

Key Selector Switches (Sub-assembled)

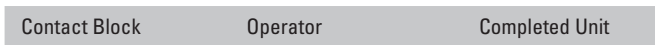

Contact Block

Terminal Style	Material	Contact	Part Number
	Solder/Tab	Silver	SPDT LB-T5
			DPDT LB-T6
			3PDT LB-T7
	PCB	Gold	SPDT LB-T1V
			DPDT LB-T2V
			3PDT LB-T3V

Operator

Style	Shape	Position	Function	Part number
	Round	2	Maintained	LB1K-2 <sup>Ⓢ</sup>
			Spring from right	LB1K-21B
		3	Maintained	LB1K-3 <sup>Ⓢ</sup>
			Spring from right	LB1K-31 <sup>Ⓢ</sup>
			Spring from left	LB1K-32 <sup>Ⓢ</sup>
			Spring from both	LB1K-33D
	Square	2	Maintained	LB2K-2 <sup>Ⓢ</sup>
			Spring from right	LB2K-21B
		3	Maintained	LB2K-3 <sup>Ⓢ</sup>
			Spring from right	LB2K-31 <sup>Ⓢ</sup>
			Spring from left	LB2K-32 <sup>Ⓢ</sup>
			Spring from both	LB2K-33D
	Rectangular	2	Maintained	LB3K-2 <sup>Ⓢ</sup>
			Spring from right	LB3K-21B
		3	Maintained	LB3K-3 <sup>Ⓢ</sup>
			Spring from right	LB3K-31 <sup>Ⓢ</sup>
			Spring from left	LB3K-32 <sup>Ⓢ</sup>
			Spring from both	LB3K-33D

Style	Shape	Position	Function	Part number
	Round	2	Maintained	LB6K-2 <sup>Ⓢ</sup>
			Spring from right	LB6K-21B
		3	Maintained	LB6K-3 <sup>Ⓢ</sup>
			Spring from right	LB6K-31 <sup>Ⓢ</sup>
			Spring from left	LB6K-32 <sup>Ⓢ</sup>
			Spring from both	LB6K-33D
	Square	2	Maintained	LB7K-2 <sup>Ⓢ</sup>
			Spring from right	LB7K-21B
		3	Maintained	LB7K-3 <sup>Ⓢ</sup>
			Spring from right	LB7K-31 <sup>Ⓢ</sup>
			Spring from left	LB7K-32 <sup>Ⓢ</sup>
			Spring from both	LB7K-33D
	Rectangular	2	Maintained	LB8K-2 <sup>Ⓢ</sup>
			Spring from right	LB8K-21B
		3	Maintained	LB8K-3 <sup>Ⓢ</sup>
			Spring from right	LB8K-31 <sup>Ⓢ</sup>
			Spring from left	LB8K-32 <sup>Ⓢ</sup>
			Spring from both	LB8K-33D
	Round	2	Maintained	LB6MK-2 <sup>Ⓢ</sup>
			Spring from right	LB6MK-21B
		3	Maintained	LB6MK-3 <sup>Ⓢ</sup>
			Spring from right	LB6MK-31 <sup>Ⓢ</sup>
			Spring from left	LB6MK-32 <sup>Ⓢ</sup>
			Spring from both	LB6MK-33D
	Square	2	Maintained	LB7MK-2 <sup>Ⓢ</sup>
			Spring from right	LB7MK-21B
		3	Maintained	LB7MK-3 <sup>Ⓢ</sup>
			Spring from right	LB7MK-31 <sup>Ⓢ</sup>
			Spring from left	LB7MK-32 <sup>Ⓢ</sup>
			Spring from both	LB7MK-33D
Rectangular	2	Maintained	LB8MK-2 <sup>Ⓢ</sup>	
		Spring from right	LB8MK-21B	
	3	Maintained	LB8MK-3 <sup>Ⓢ</sup>	
		Spring from right	LB8MK-31 <sup>Ⓢ</sup>	
		Spring from left	LB8MK-32 <sup>Ⓢ</sup>	
		Spring from both	LB8MK-33D	

22. In place of <sup>Ⓢ</sup> specify retention option code from table below.  
 23. For standard wave key operators, add "S" to part number before the key retention code from table below. (For example, LB6K-2B with wave key would be LB6K-2SB.)

<sup>Ⓢ</sup> Retention Option Code

Code	Description
A	Key not retained in any position (removable in all positions)
B	Key retained in right position only
C	Key retained in left position only
D	Key retained in left and right (3-position only)

Code	Description
E	Key retained in center only (3-position only)
G	Key retained in right and center (3-position only)
H	Key retained in left and center (3-position only)

Switches & Pilot Devices

Signaling Lights

Relays & Sockets

Timers

Contactors

Terminal Blocks

Circuit Breakers

### Lever Switches (Assembled)



Style	Operator Position	Contact	Solder/Tab Terminal (silver contacts)	PC Board Terminal (gold contacts)
 Standard Bezel (black)	2-position	Maintained U D	SPDT LB⊙T-2T5	LB⊙T-2T1V
			DPDT LB⊙T-2T6	LB⊙T-2T2V
			3PDT LB⊙T-2T7	LB⊙T-2T3V
 Flush Bezel (black)	3-position	Maintained U C D	DPDT LB⊙T-3T2	LB⊙T-3T6V
			3PDT LB⊙T-3T3	LB⊙T-3T7V
		Spring return from top/bottom U C D	DPDT LB⊙T-33T2	LB⊙T-33T6V
		3PDT LB⊙T-33T3	LB⊙T-33T7V	

24. For all part numbers, specify bezel in place of ⊙. 1 (standard bezel), 6 (flush bezel).  
 25. See page page 522 for contact operation.  
 26. See page page 533 for dimensions.

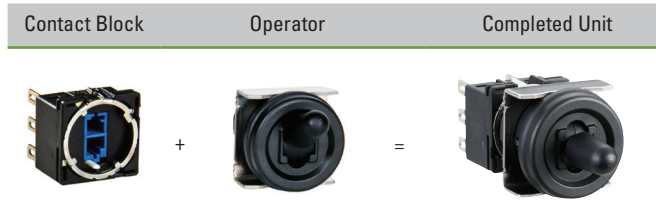

### Lever Switches (Sub-assembled)



#### Contact Block

Terminal Style	Material	Contact	Part Number
 Solder/Tab	Silver	SPDT	LB-T5
		DPDT	LB-T6
		3PDT	LB-T7
	Gold	SPDT	LB-T1
		DPDT	LB-T2
		3PDT	LB-T3
 PCB	Gold	SPDT	LB-T1V
		DPDT	LB-T2V
		3PDT	LB-T3V

#### Operator

Style	Position	Function	Part Number
 Round Standard (Plastic)	2	Maintained	LB1T-2
		Maintained	LB1T-3
	3	Spring return from both	LB1T-33
 Round Flush Mount (Plastic)	2	Maintained	LB6T-2
		Maintained	LB6T-3
	3	Spring return from both	LB6T-33

**Buzzers (Assembled)**

Style	Shape	Voltage	Standard Bezel		Flush Bezel	
			Solder/Tab Terminal	PC Board Terminal	Solder/Tab Terminal	PC Board Terminal
Black Bezel   	Round	12V DC	–	–	LB6Z-1T03	LB6Z-1T03V
		24V DC	–	–	LB6Z-1T04	LB6Z-1T04V
	Rectangular	12V DC	LB3Z-1T03	LB3Z-1T03V	LB8Z-1T03	LB8Z-1T03V
		24V DC	LB3Z-1T04	LB3Z-1T04V	LB8Z-1T04	LB8Z-1T04V
Metallic Bezel  	Round	12V DC	–	–	LB6MZ-1T03	LB6MZ-1T03V
		24V DC	–	–	LB6MZ-1T04	LB6MZ-1T04V
	Rectangular	12V DC	–	–	LB8MZ-1T03	LB8MZ-1T03V
		24V DC	–	–	LB8MZ-1T04	LB8MZ-1T04V

27. IP54 Rated.  
 28. For IP40 rating, use part number LB3Z-104K.  
 29. See page 534 for dimensions.

**Buzzers (Sub-assembled)**



**Contact Block**

Terminal Style	Part Number
	LB-T00
	LB-T00V

**Operator**

Style	Mounting Style	Shape	Voltage	
			12V DC	24V DC
	Standard (Plastic)	Rectangular	LB3Z-103	LB3Z-104
		Round	LB6Z-103	LB6Z-104
	Flush Mount (Plastic)	Rectangular	LB8Z-103	LB8Z-104
		Round	LB6MZ-103	LB6MZ-104
	Flush Mount (Metallic)	Rectangular	LB8MZ-103	LB8MZ-104



**Contact Operation**

**Selector Switch, Illuminated Selector Switch, Key Selector Switch**

Operator Position & Contact Operation (Top View)

Position		Contact	Left	Center	Right
90° 2-position	<p>Maintained</p>	SPDT			
		DPDT			
		3PDT			
45° 3-position	<p>Maintained</p>	DPDT			
		3PDT			
45° 3-position	<p>Spring return from right</p>	<p>Spring return from left</p>	<p>Spring return two-way</p>	DPDT	
				3PDT	
				DPDT	
				3PDT	
45° 3-position	<p>Spring return two-way</p>	<p>Spring return two-way</p>	<p>Spring return two-way</p>	DPDT	
				3PDT	
				DPDT	
				3PDT	

**Lever Switch**

Lever Position & Contact Operation (Top View)

Position		Contact	Down	Center	Up
90° 2-position	<p>Maintained</p>	SPDT			
		DPDT			
		3PDT			
45° 3-position	<p>Maintained</p>	DPDT			
		3PDT			
45° 3-position	<p>Spring return two-way</p>	<p>Spring return two-way</p>	<p>Spring return two-way</p>	DPDT	
				3PDT	
				DPDT	
				3PDT	

**Mounting Hole Layout (mm)**

Standard Bezels

LB1/LB2/LB3

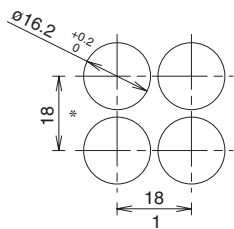

\*1. Rectangular: 24mm  
3PDT: 23.2mm  
\*2. 3PDT: 21mm

Flush Bezels

Round

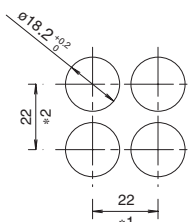

Square

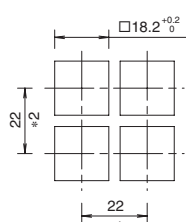

Rectangular

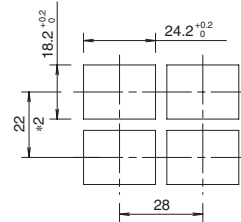

1. 3PDT: 23.2mm  
2. Switches with Guard: 45mm

When using the LB series with a rubber boot or terminal cover, make sure to note the dimensions on pages page 537 and page 538.

## PC Board Drilling Layout (mm)

### Notes for Designing PC Board and Circuit

1. Use 1.6mm-thick glass epoxy PC board with drilled holes.
2. Design a circuit so that the LB series can operate within the rated voltage and current range. Make sure that inrush current and voltage do not exceed the rating.
3. Minimum applicable load is 5V AC/DC, 1mA on gold contacts.
4. Since the \*2.8mm-wide terminal touches the PC board as shown below, short circuit may occur with pattern lines. Design a circuit that prevents short circuits.

### SPDT/DPDT Contacts

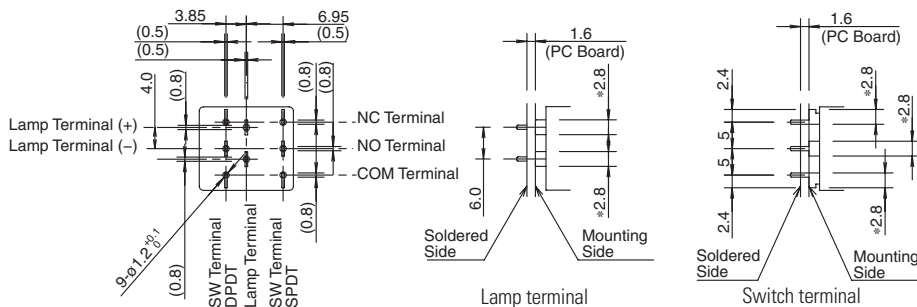

### 3PDT Contacts

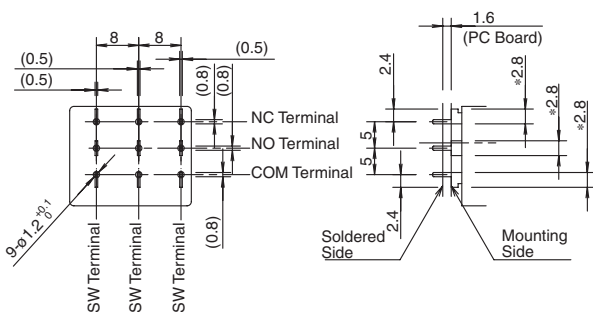

### PC Board Drilling Layout (Bottom View)

#### SPDT/DPDT Contacts

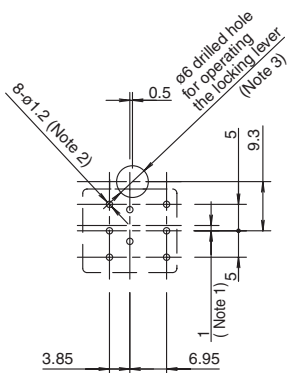

#### 3PDT Contacts

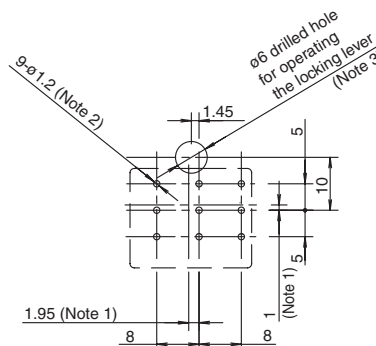

5. When designing, note the alignment of the center lines of the contact blocks and operators.
6. The diameter of the terminal hole is ø1.2.
7. Hole diameter may vary to meet installation requirements. Determine the location and the size of the hole so that the locking lever can be operated.

### Dimensions (mm) Illuminated Pushbuttons

#### Standard Bezels

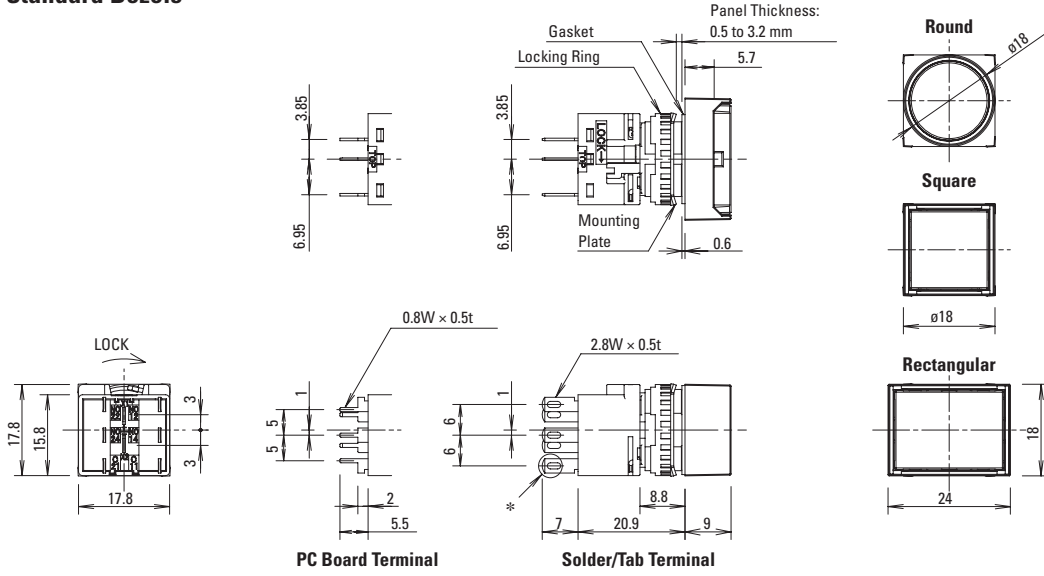

#### Flush Bezels SPDT/DPDT Contacts

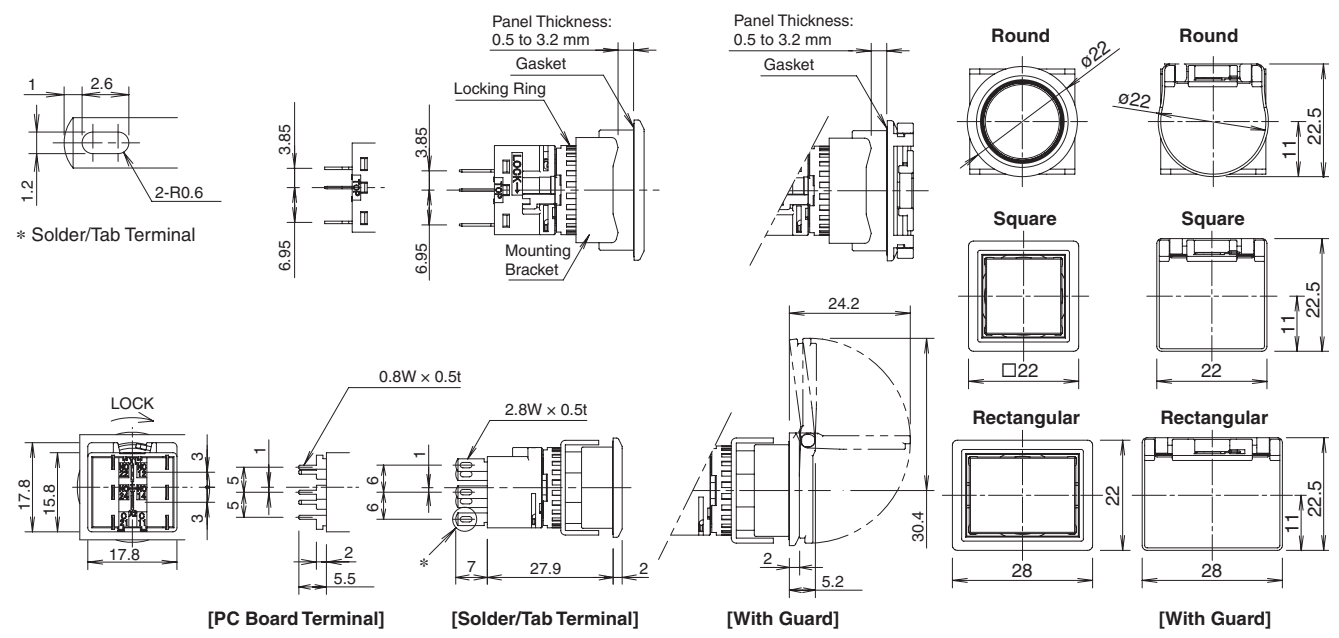

### Terminal Arrangement (Bottom View)

#### Illuminated Pushbuttons

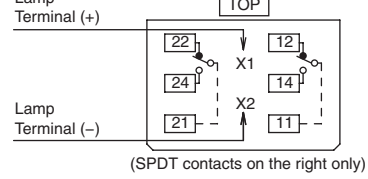

#### Pilot Lights

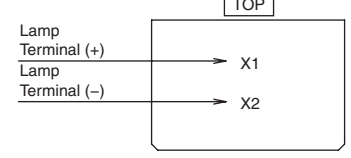

### Pilot Lights

Standard Bezels

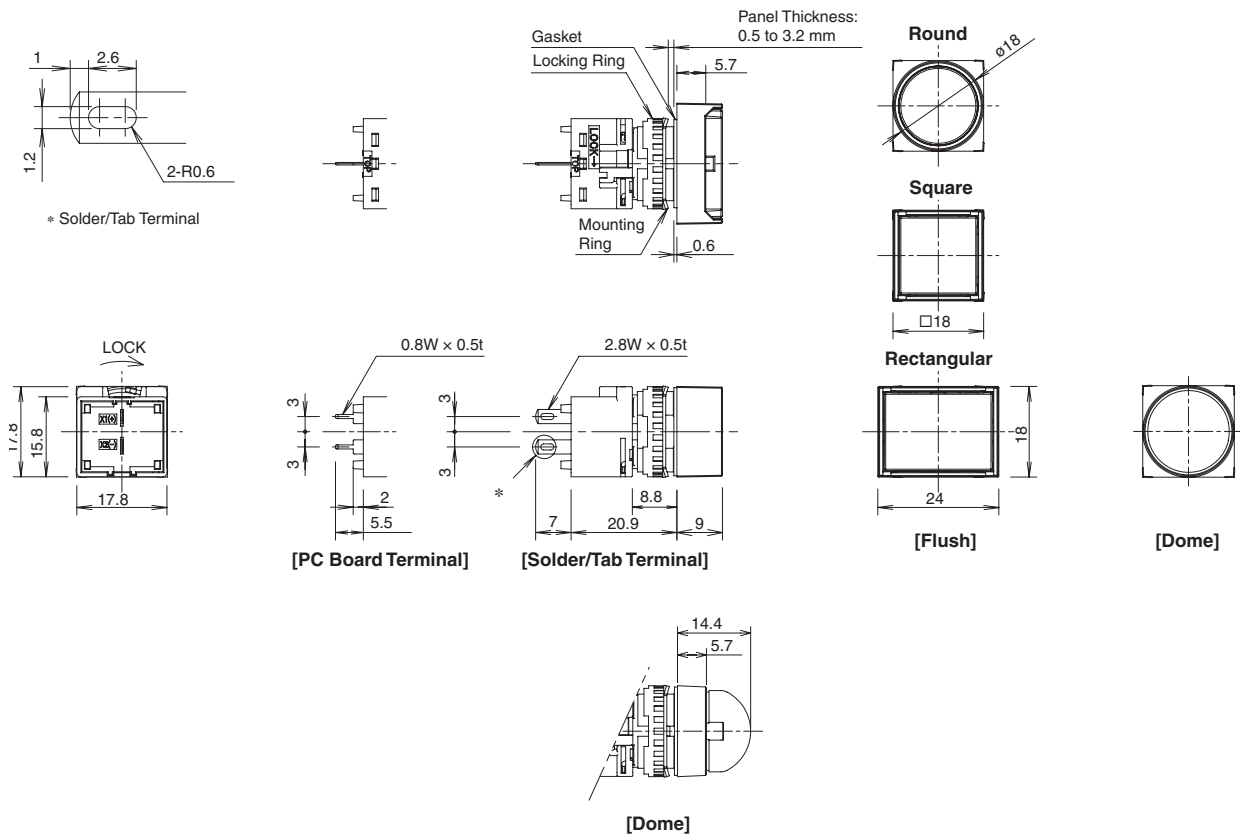

Flush Bezels

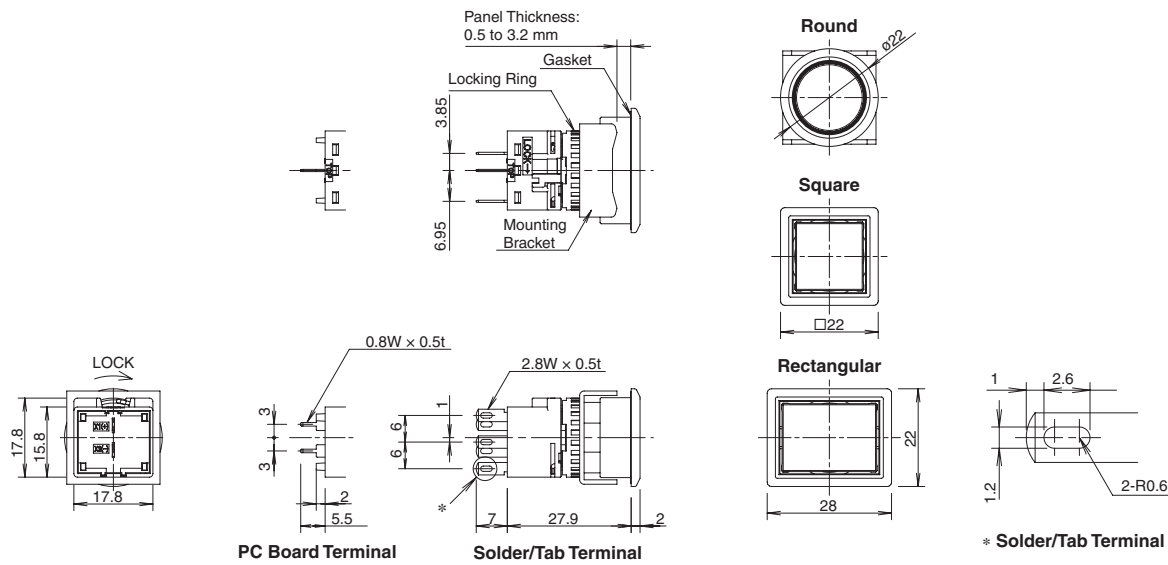

### Non-Illuminated Pushbuttons

#### Standard Bezels

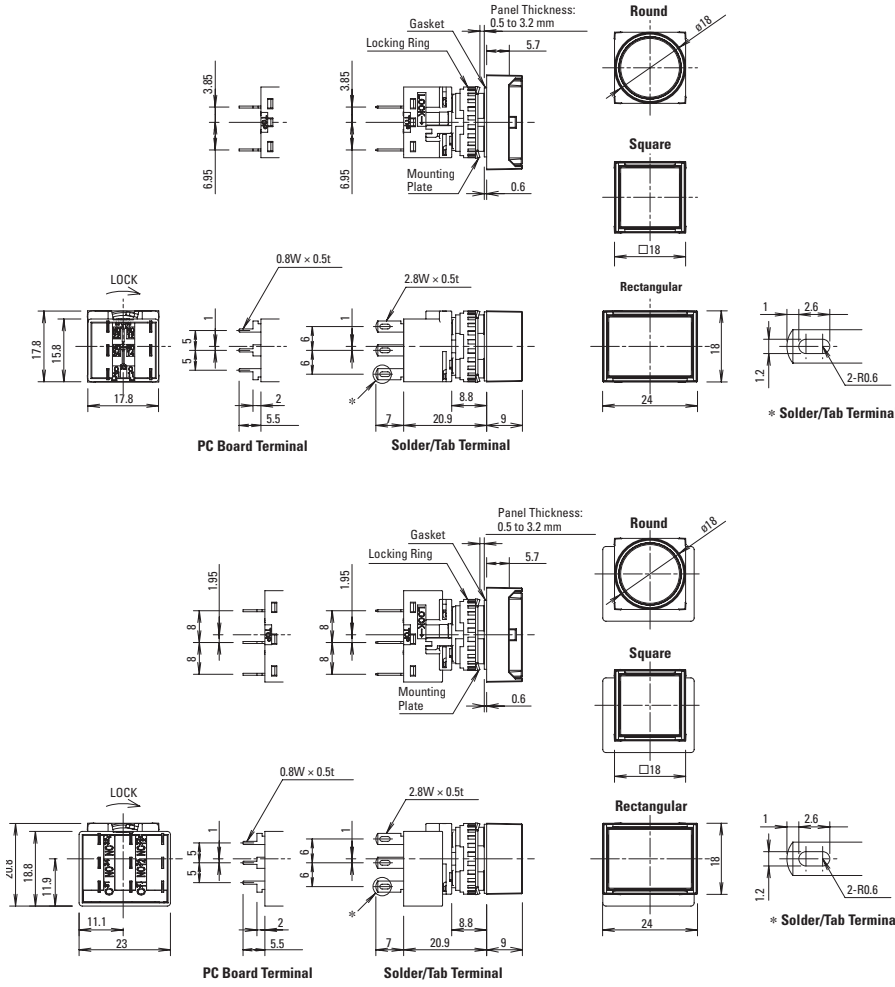

#### Terminal Arrangement (Bottom View)

##### SPDT/DPDT Contacts

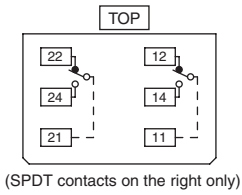

##### 3PDT Contacts

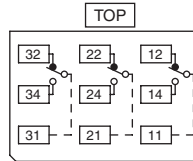

Non-Illuminated Pushbuttons

Flush Bezels

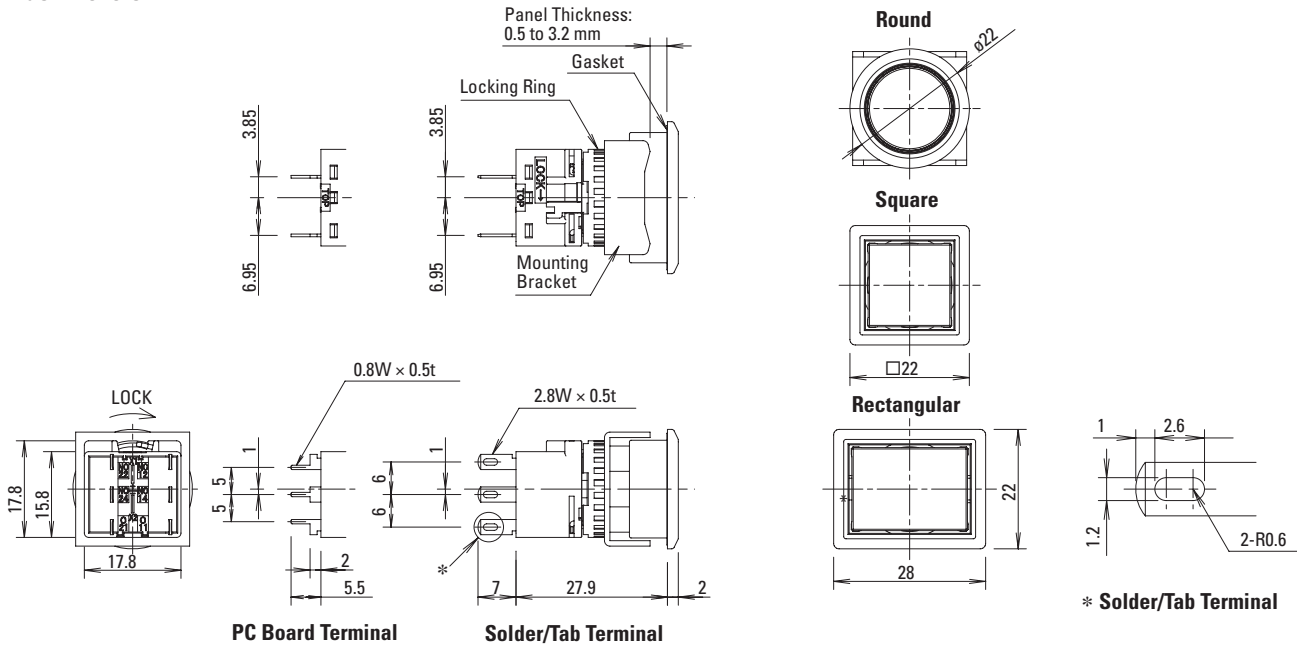

Selector Switches

Standard Bezels

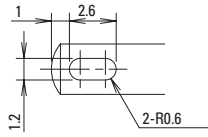

\* Solder/Tab Terminal

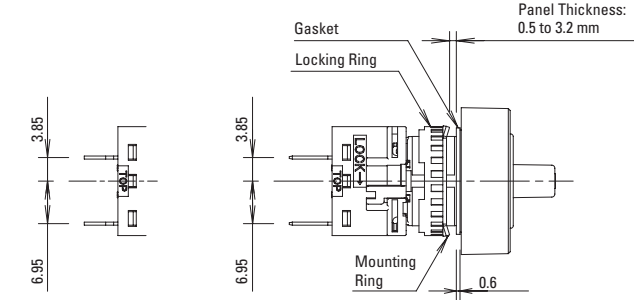

[SPDT/DPDT]

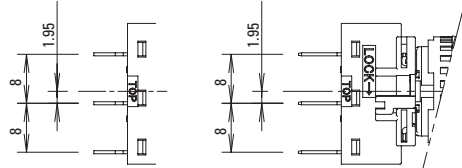

[3PDT]

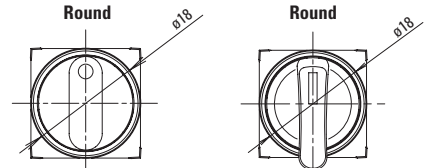

Round

Square

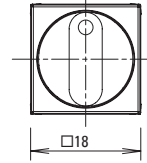

Rectangular

Rectangular

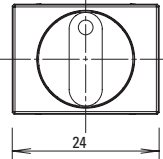

[Knob Operator]

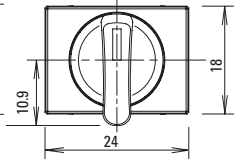

[Lever Operator]

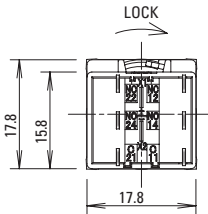

[SPDT/DPDT]

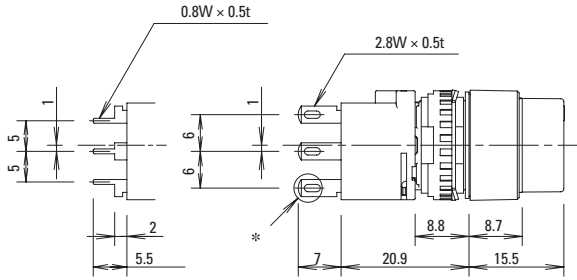

[PC Board Terminal]

[Knob Operator PC Board Terminal]

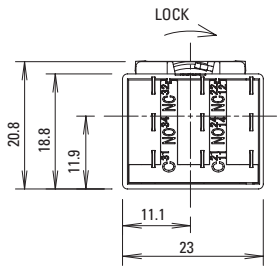

[3PDT]

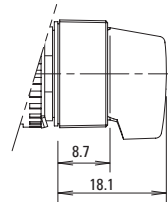

[Lever Operator]

### Selector Switches

#### Flush Bezels

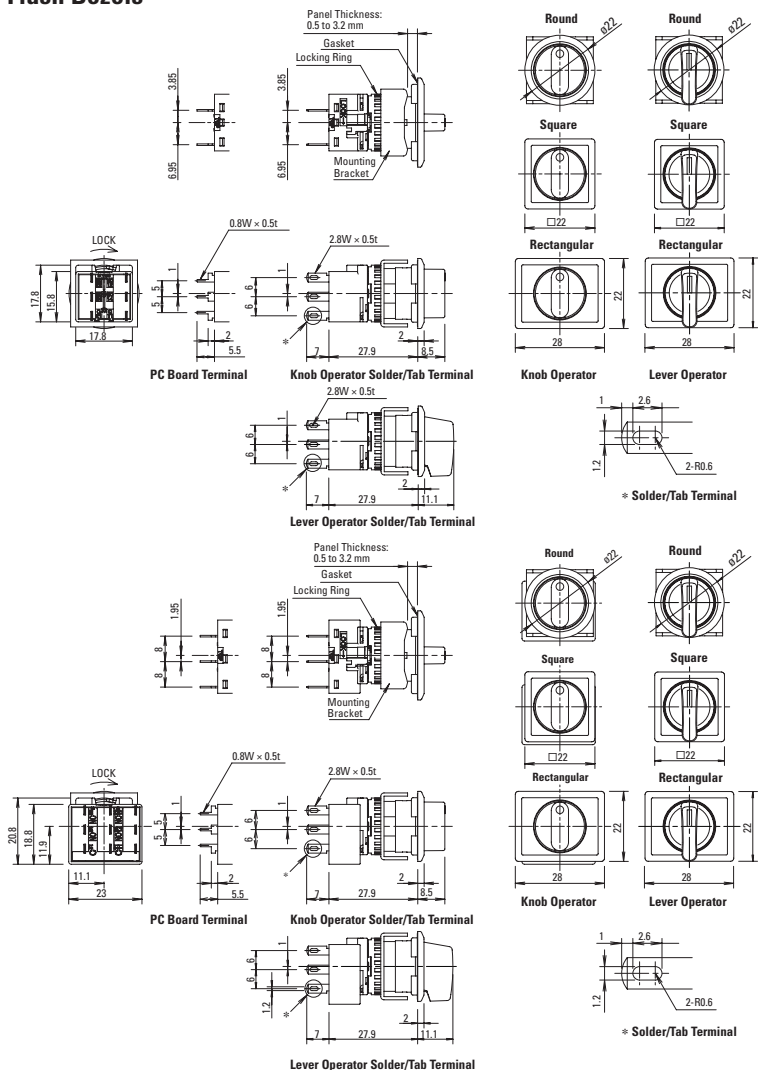

### Terminal Arrangement (Bottom View)

#### SPDT/DPDT Contacts

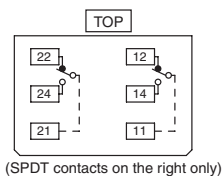

#### 3PDT Contacts

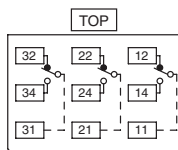



### Illuminated Selector Switches

#### Standard Bezels

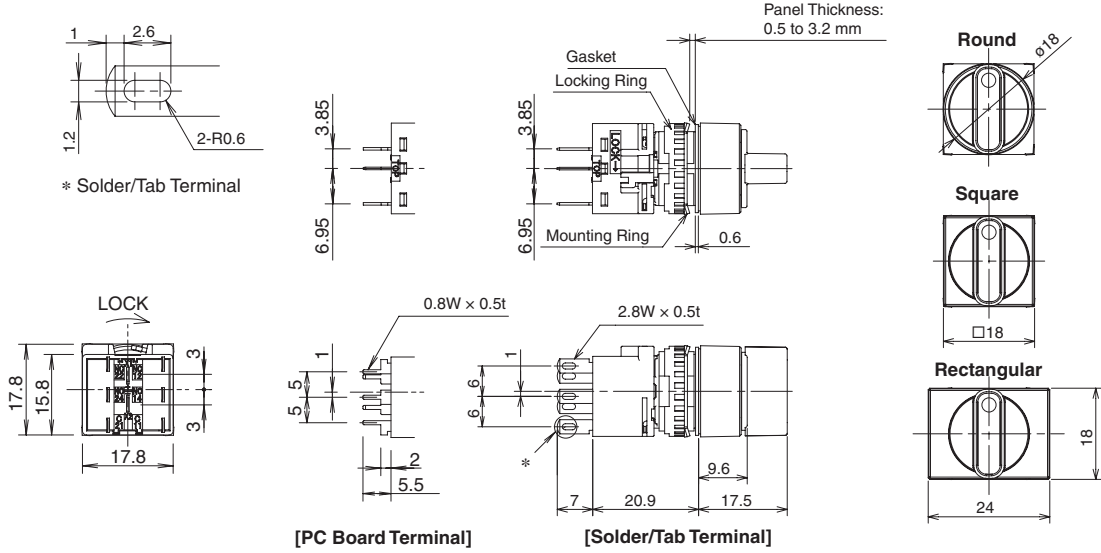

#### Flush Bezels

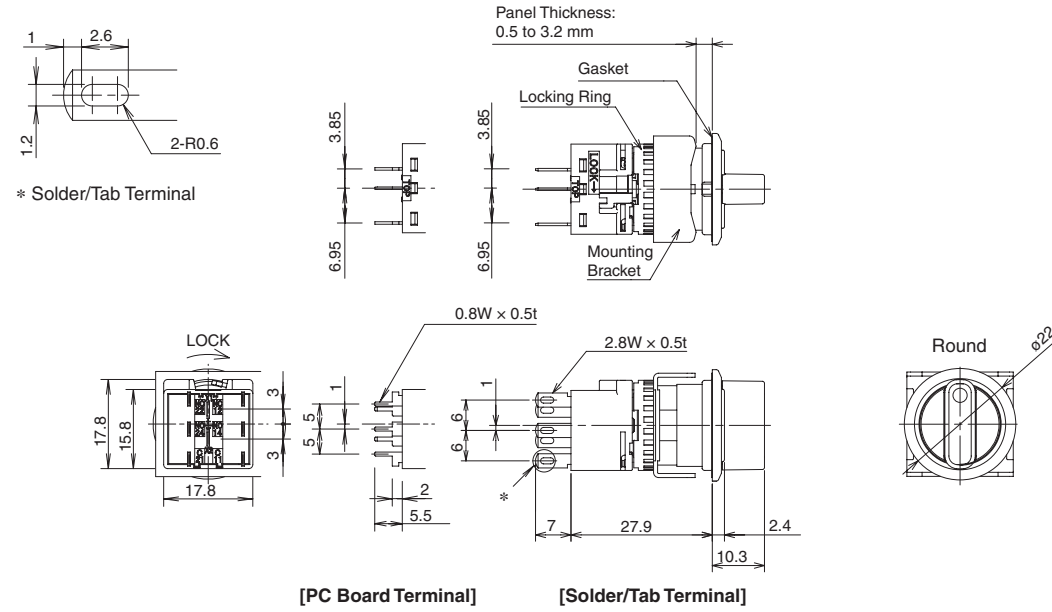

### Terminal Arrangement (Bottom View)

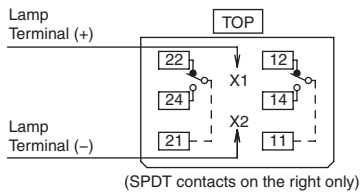

### Key Selector Switches

#### Standard Bezels With Wave Key

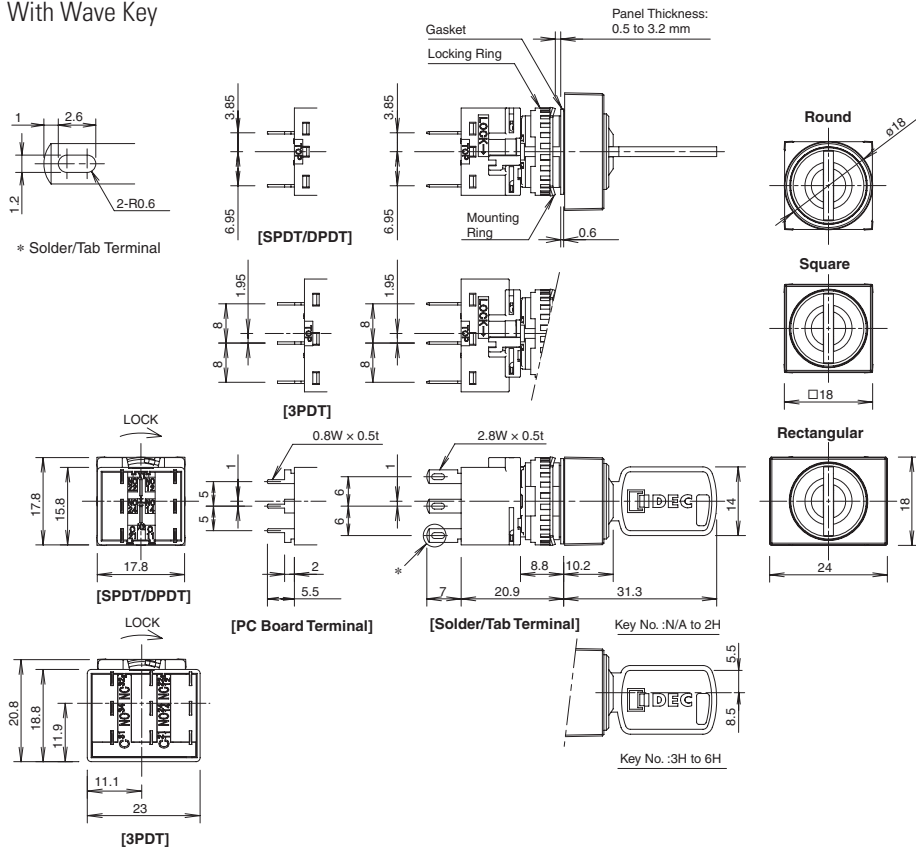

#### With Standard Key

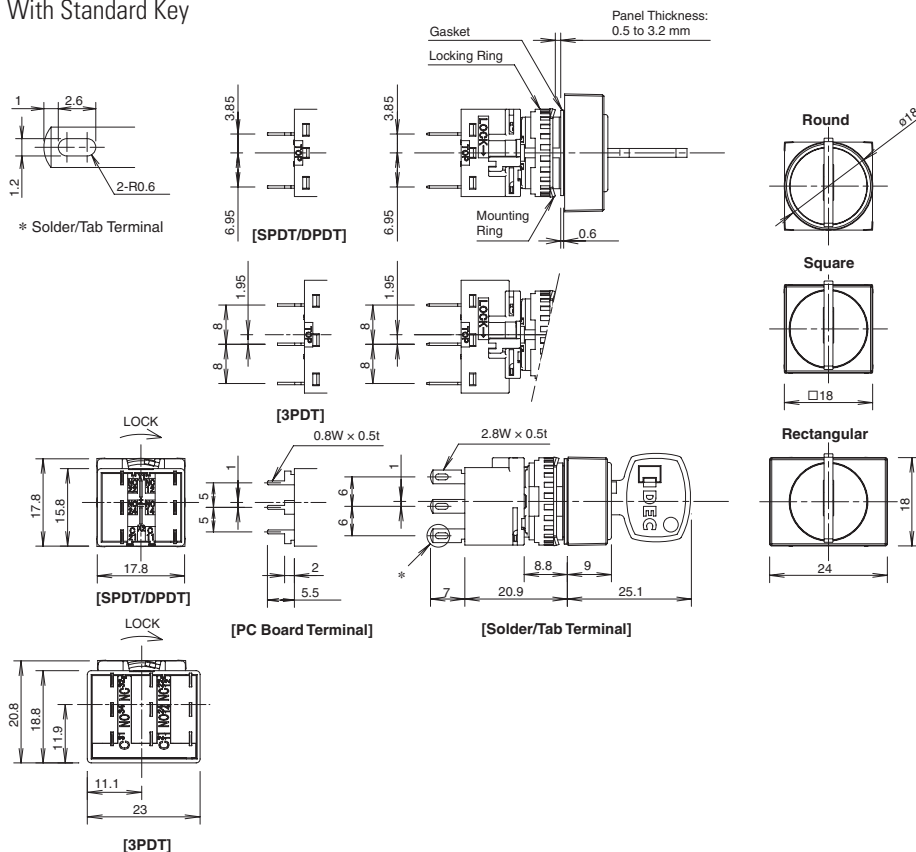

### Key Selector Switches

**Flush Bezels**  
With Wave Key

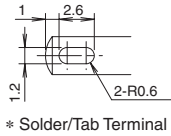

\* Solder/Tab Terminal

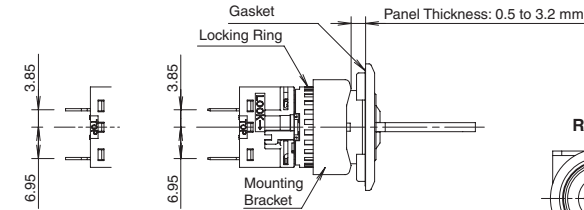

[SPDT/DPDT]

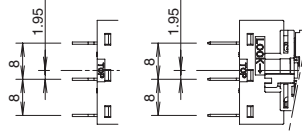

[3PDT]

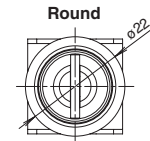

Round

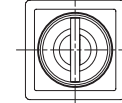

Square

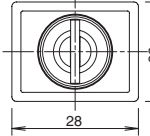

Rectangular

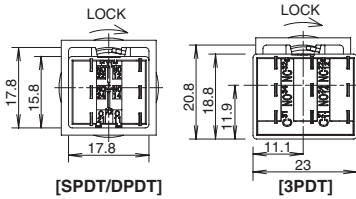

[SPDT/DPDT]

[3PDT]

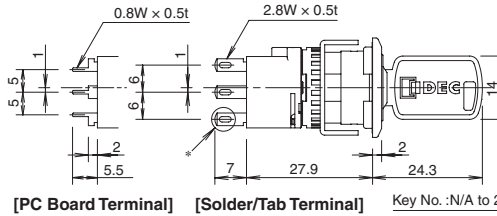

[PC Board Terminal]

[Solder/Tab Terminal]

Key No.: N/A to 2H

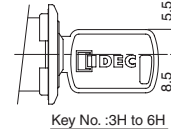

Key No.: 3H to 6H

With Standard Key

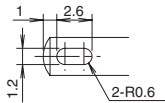

\* Solder/Tab Terminal

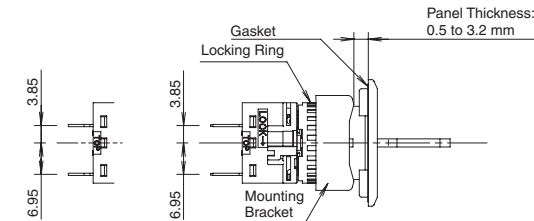

[SPDT/DPDT]

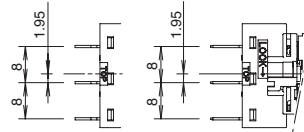

[3PDT]

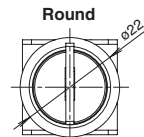

Round

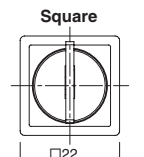

Square

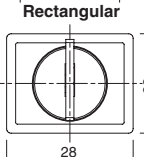

Rectangular

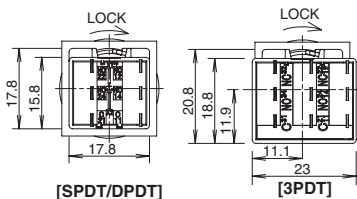

[SPDT/DPDT]

[3PDT]

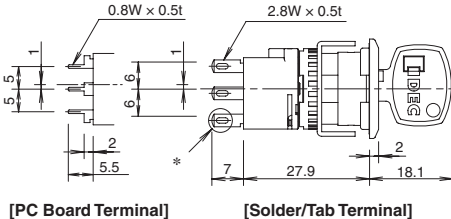

[PC Board Terminal]

[Solder/Tab Terminal]

**Terminal Arrangement (Bottom View)**

**SPDT/DPDT Contacts**

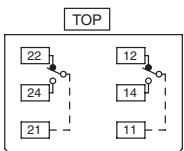

(SPDT contacts on the right only)

**3PDT Contacts**

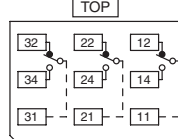

Lever Switches

Panel Thickness: 0.5 to 3.2 mm

Standard Bezels

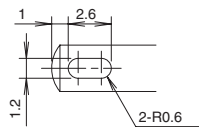

\* Solder/Tab Terminal

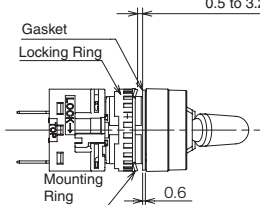
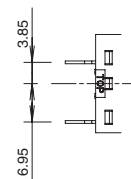

[SPDT/DPDT]

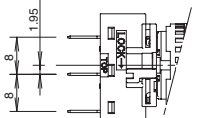
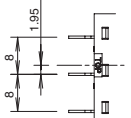

[3PDT]

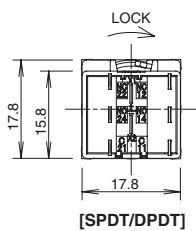

[SPDT/DPDT]

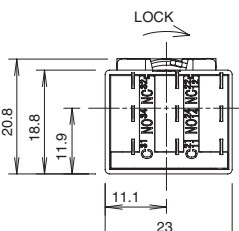

[3PDT]

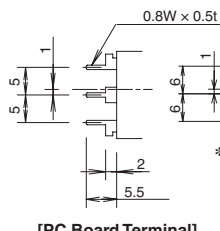

[PC Board Terminal]

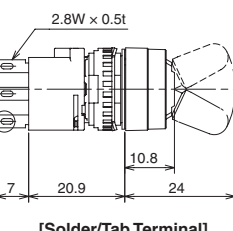

[Solder/Tab Terminal]

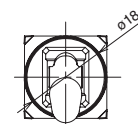

Flush Bezels

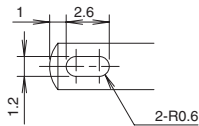

\* Solder/Tab Terminal

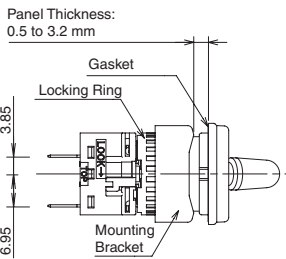
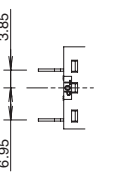

[SPDT/DPDT]

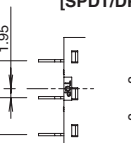

[3PDT]

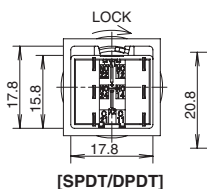

[SPDT/DPDT]

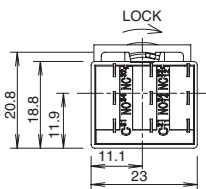

[3PDT]

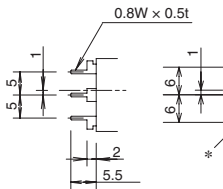

[PC Board Terminal]

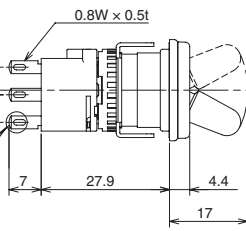

[Solder/Tab Terminal]

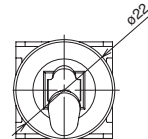

Terminal Arrangement (Bottom View)

SPDT/DPDT Contacts

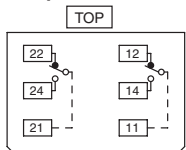

(SPDT contacts on the right only)

3PDT Contacts

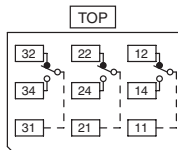

Buzzers

Standard Bezels

IP54

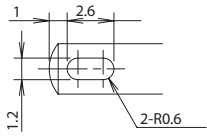

\* Solder/Tab Terminal

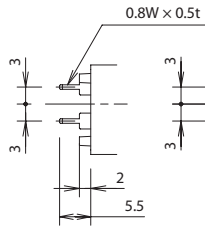
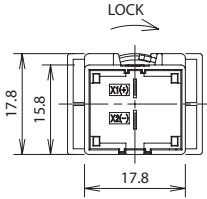
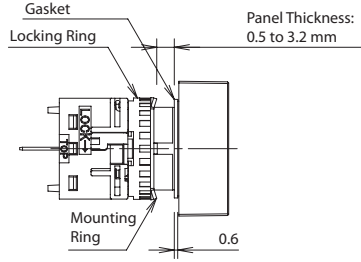

[PC Board Terminal]

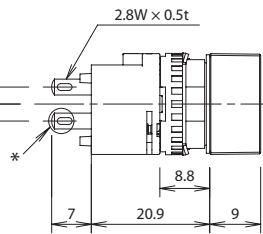

[Solder/Tab Terminal]

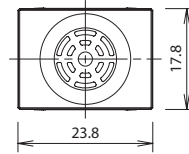

IP40

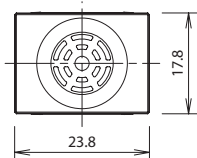
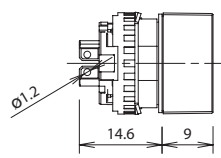
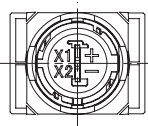
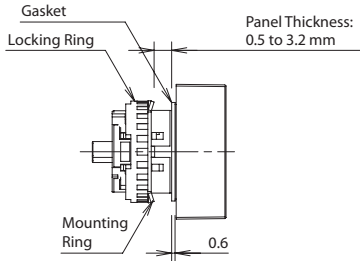

Terminal Arrangement (Bottom View)

Flush & Standard IP54

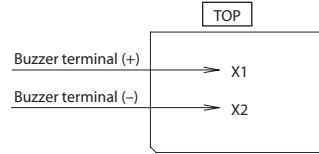

IP40

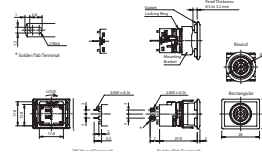

Flush Bezels

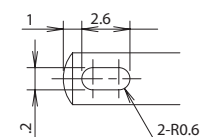

\* Solder/Tab Terminal

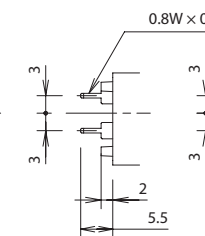
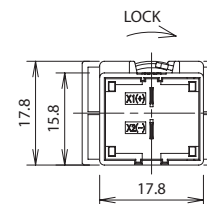
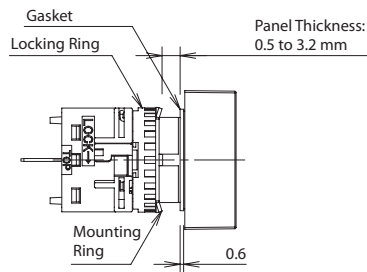



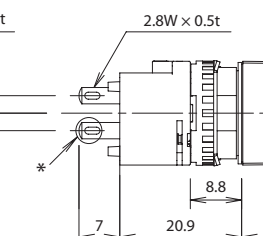

[PC Board Terminal]

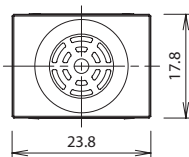

[Solder/Tab Terminal]

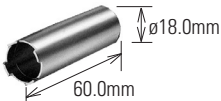
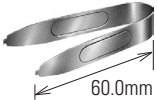
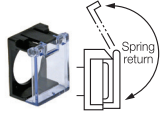

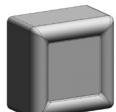
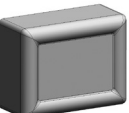
Accessories

Item	Material	Part Number	Remarks	
Locking Ring Wrench 	Metal: Nickel-plated brass	MT-001	Used to tighten the locking ring when installing the units on to the panel.	
Lens Removal Tool 	Stainless Steel	MT-101	Used to remove the lens or button.	
Switch Guard (180° Spring return) 	For round / square standard units	Guard: Polyacetal Base: Polyarylate	Degree of protection: IP65 Used to protect standard pushbuttons and illuminated pushbuttons from inadvertent operation. See page page 538 for dimensions. With the gasket mounted on the switch, attach the switch guard and mount on the panel.  Note: not applicable for flush mounted units. Select operator with built-in switch guard.	
	For rectangular standard units	AL-KH6SP		
Switch Guard for Single Board Mounting 	For rectangular units	Guard: Polyacetal Base: Polyarylate	Degree of protection: IP65 With the gasket mounted on the switch, attach the switch guard and mount on the panel. See page page 538 for dimensions.	
Rubber Boot for Standard Bezels 1  2  3 	1. For round units	Silicon Rubber	Degree of protection: IP65 See page page 537 for dimensions. See page page 540 for mounting.	
	2. For square units			LB9Z-D2
	3. For rectangular units			LB9Z-D3
Mounting Hole Plug 	Metal	Plug: Metal (Zinc diecast) Locking nut: Polyacetal Gasket: Nitrile rubber	Degree of protection: IP65 Tightening torque: 0.1 to 0.29 N•m See page page 537 for dimensions.	
Mounting Hole Plug 	Rubber	Nitrile rubber (black)	Degree of protection: IP65 See page page 537 for dimensions.	

For Standard Bezels

Switches & Pilot Devices

Signaling Lights

Relays & Sockets







Timers

Contactors

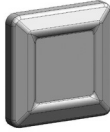
Terminal Blocks

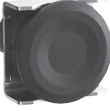
Circuit Breakers

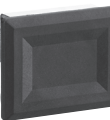
Accessories con't

Item	Material	Part Number	Remarks
Rubber Boot for Flush Bezels			
1 	Silicon Rubber	1. For round units	Degree of protection: IP65 See page page 537 for dimensions. See page page 540 for mounting.
2 		2. For square units	
3 		3. For rectangular units	
For Flush Bezels			
Mounting Hole Plug			
1 	Plug: Polyamide (Black) Gasket: Nitrile rubber Mounting Plate: Stainless Steel	1. For round units	Degree of protection: IP65 Panel thickness: 0.5 to 3.2mm See page page 537 for dimensions.
2 		2. For square units	
3 		3. For rectangular units	
Terminal Cover			
1  2 		1. For SPDT/DPDT contacts	See page page 538 for dimensions.
		2. For 3PDT contacts	

Accessory Dimensions (mm)

Rubber Boot

Standard Bezel

For round units (LB9Z-D1)

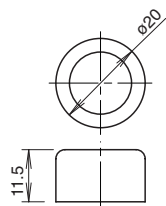

For square units (LB9Z-D2)

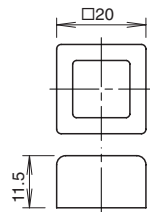

For rectangular units (LB9Z-D3)

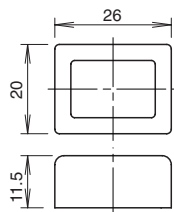

Flush Bezel

For round units (LB9Z-D6)

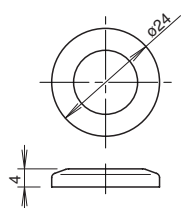

For square units (LB9Z-D7)

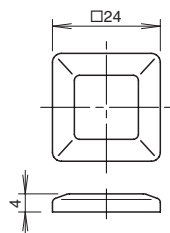

For rectangular units (LB9Z-D8)

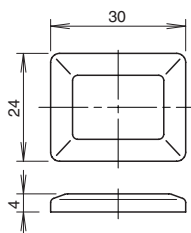

Mounting Hole Plug

Standard Bezels

AL-B6

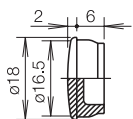

AL-BM6

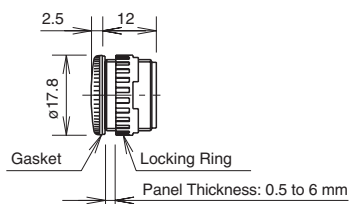

Flush Bezels

For round units (LB9Z-BS6)

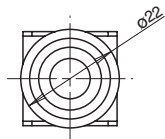

Mounting Hole Layout

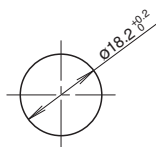

For square units (LB9Z-BS7)

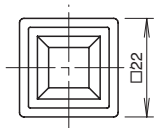

Mounting Hole Layout

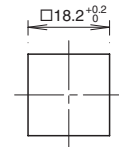

For rectangular units (LB9Z-BS8)

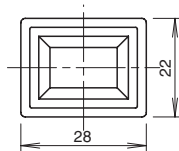

Mounting Hole Layout

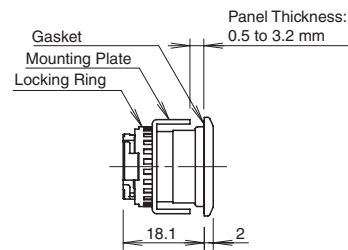
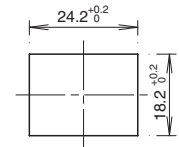



Accessory Dimensions (mm) con't

Terminal Cover

Standard Bezel

For SPDT/DPDT contacts (LB9Z-VL2)

For 3PDT contacts (LB9Z-VL3)

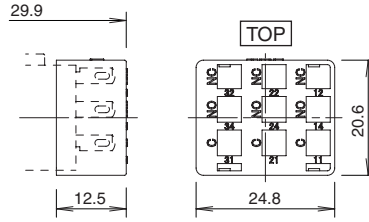
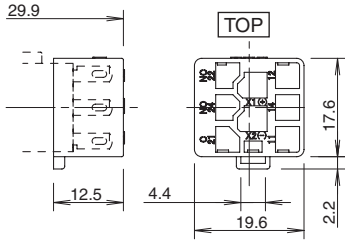

Switch Guard for Standard Bezel Models

For round / square units (AL-K6SP)

For rectangular units (AL-KH6SP)

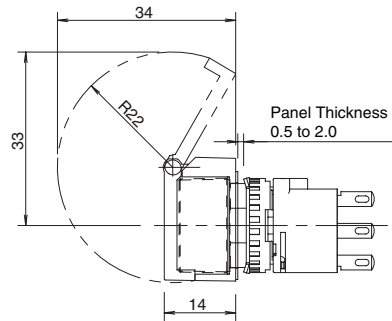
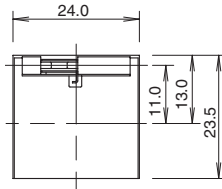
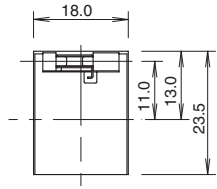

For Single Board Mounting (LA9Z-K3)

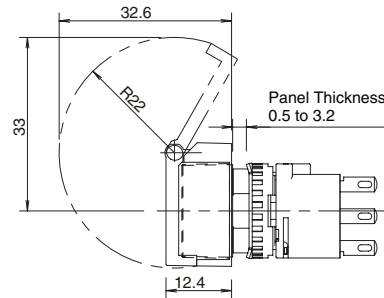
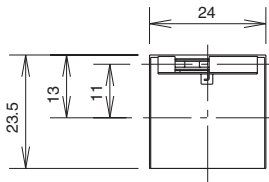

Note: The panel depth is the same for switches with or without switch guards. Both models can be installed on the same PC board.

Standard Key

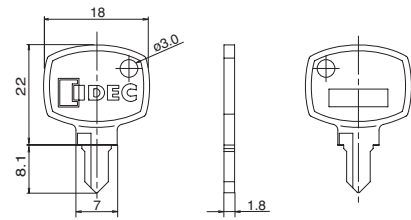

Wave Key

Reversible Wave Key

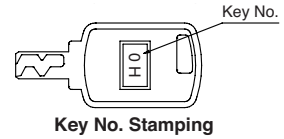
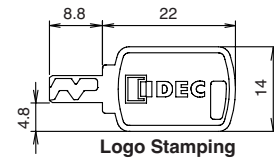

Non-reversible Wave Key

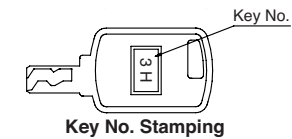
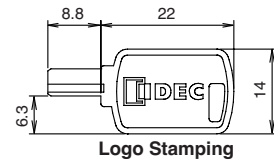

Replacement Parts

Item	Material	Part Number	Remarks
Lens 	For round units	Polyarylate ø15.4 H4mm	AL6M-L <sup>②</sup>
	For square units	Polyarylate □15.4, H4mm	AL6Q-L <sup>②</sup>
	For rectangular units	Polyarylate W21.4 x H4 x D15.4mm	AL6H-L <sup>②</sup>
Button 	For round units	Polyarylate □15.4, H4mm	AB6M-B <sup>②</sup>
	For square units	Polyarylate □15.4, H4mm	AB6Q-B <sup>②</sup>
	For rectangular units	Polyarylate W21.4 x H4 x D15.4	AB6H-B <sup>②</sup>
Marking Plate 	For round units	Acrylic ø13.7 H0.8	AL6M- <sup>②</sup>
	For square units	Acrylic □13.7, H0.8mm	AL6Q- <sup>②</sup>
	For rectangular units	Acrylic W19.7 x H0.8 (0.4) x D13.7mm	AL6H- <sup>②</sup>
Locking Ring 	For all units	Polyamide ø17.9, H3.9mm	LB9Z-LNP
Anti-rotation Ring 	For standard bezel	Metal (Stainless steel) □17.9, t0.6mm	LB9Z-LP1
Anti-rotation Ring 	For flush bezel	Metal (Stainless steel) W21 x H8.2 x D20.6 t0.8mm	LB9Z-LP6
Spare Standard Key 	For key selector switches	Nickel-plated Brass	AS6-SK
Spare Wave key Non-reversible Wave Key  Reversible Wave Key 	For Wave key selector switches	Diecast zinc alloy (nickel plated) W14 x H2 x D30.8mm	LA9Z-SK- <sup>⑤</sup>

LB Series Replacement LED Unit

Item	Rated Operating Voltage	Part Number	②Color Code	Remarks
LED Unit 	DC5V	LB9Z-LED5 <sup>②</sup>	A G PW R S	8. Specify color code in place of the ② in the part number. R: Red, G: Green, A: Amber, S: Blue, PW: White 9. All illuminated LB series contain an LED unit. 10. Use a white (PW) LED unit for yellow (Y) illumination.
	AC/DC12V	LB9Z-LED1 <sup>②</sup>		
	AC/DC24V	LB9Z-LED2 <sup>②</sup>		

**Precautions & Instructions**  **Safety Precautions**

- Turn off the power to the LB series control units before installation, removal, wiring, maintenance, and inspection. Failure to turn power off may cause electrical shocks or fire hazard.
- To avoid burning your hand, use the lamp holder tool when replacing the lamps.

- For wiring, use wires of a proper size to meet voltage and current requirements. Solder correctly according to the instructions in "Wiring" and "Notes on Terminal Cover." Improper soldering may cause overheating and create a fire hazard. Also, when using tab terminals, use receptacles of appropriate size.

**Instructions**

**Wiring**

1. Solder the terminals at 350°C within 3 seconds using a 60W soldering iron. Sn-Ag-Cu type is recommended. When soldering, do not touch the LB series with the soldering iron. Also ensure that no tensile force is applied to the terminals. Do not bend the terminal or apply excessive force to the terminal.
2. Use non-corrosive liquid flux.

**Terminal Cover**

Solder/tab terminal  
Insert the terminal cover into the contact block with the TOP markings on the contact block and the terminal cover in the same direction.

Note: When wiring, insert the lead wires into the terminal cover holes before soldering. After wiring, terminal covers cannot be installed.

**Standard Bezel**

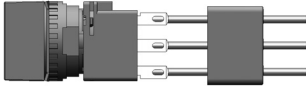

**Flush Bezel**

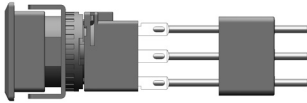

**Operating Environment**

- Do not use the LB series where corrosive gases exist or under an environment exceeding the operating temperature and humidity ranges. Otherwise, damage such as contact failure or change of the surface color may occur.
- Major parts of the switch are plastic. Scratches or damage may occur when scraped with a sharp object or if excessive load or shock is applied. Note that this may cause operation and appearance failure of the operator and bezel.
- Application of detergent, cutting oil, or special chemicals to the switch may result in operation and/or appearance failure such as a change in surface color.

**Handling**

Contacts (micro switch)  
When using NC (normally closed) and NO (normally open) contacts of the same microswitch, avoid connections of different voltages, or connections of different types of power supplies. Failure to observe this instruction may cause a short-circuit.

**Removing and Installing the Contact Block**

3. Turn the locking lever on the contact block in the direction opposite to the arrow on the housing. Then the contact block can be removed.
4. Insert the contact block with the TOP markings on the contact block and the operator placed in the same direction. Then lock the units, turning the locking lever in the direction of the arrow.

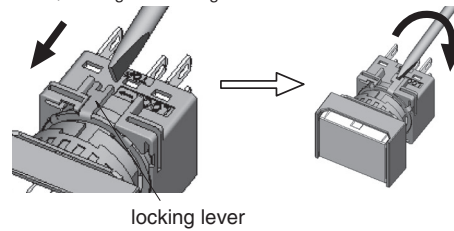

**Panel Mounting**

Remove the contact block from the operator. Insert the operator into the panel cut-out from the front, then install the contact block to the operator.

**Standard Bezel**

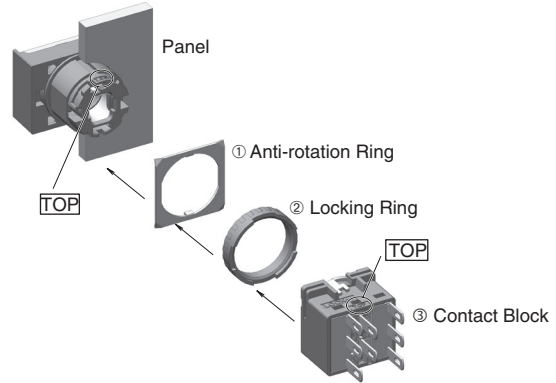

**Flush Bezel**

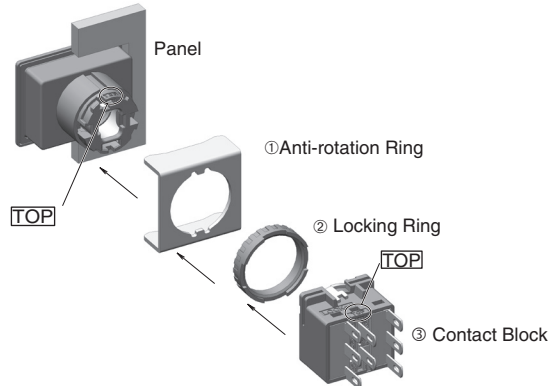

**Notes on Mounting**

Use the optional ring wrench (MT-001) to mount the operator onto the panel. Tightening torque should not exceed 0.7 N·m. Do not use pliers. Excessive tightening will damage the locking ring.

## X-ON Electronics

Largest Supplier of Electrical and Electronic Components

*Click to view similar products for [idec manufacturer](#):*

Other Similar products are found below :

[LT7A-XE-G](#) [LT7A-XE-R](#) [LT7B-A250](#) [LT7B-A250FB](#) [LW1B-M1C6-W](#) [LW6L-M1C24MG](#) [FB1T-000Z](#) [FB1W-XW1E-BV411MR](#) [FB3W-413Z](#) [FC2A-KP1C](#) [FC4A-J8AT1](#) [FC4A-T16S3](#) [FC5A-C16R2C](#) [MM-SMART-24](#) [MM-SMART-40](#) [FT1A-C12RA-S](#) [FT1A-C12RA-W](#) [FT1A-C14SA-B](#) [PF3S-BP12](#) [PS3X-D24AFG](#) [PS3X-Q12AFG](#) [GT3A-3AD24](#) [GT3F-2EAD24](#) [GT3S-2AF20](#) [GT3W-A16AD24](#) [ABD302N-R](#) [ABD410N-R](#) [ABFD411N-G](#) [ABN4F11-G](#) [ABPD201N-R](#) [HE2B-M211PB](#) [HE2G-21SH](#) [HE9Z-D3B](#) [HG9Z-2A1](#) [HG9Z-XC300](#) [ACSNO-6123-FB-C6002](#) [RH3V2-UAC240V](#) [DFAN-031-B](#) [AL6M-LK1-G](#) [AL6M-P3-R](#) [AL6Q-M13-W](#) [AL6Q-M23P-QG](#) [ALFD29901DN-G-24V](#) [ALFN22211DNG-U](#) [ALFW224611D-W](#) [ALNE8811-G](#) [ALQW2B24611D-G](#) [ALW212611-G](#) [ALW22211DG](#) [ALW29902D-G-12V](#)