

PNOZ m EF 4DI4DOR

PILZ
THE SPIRIT OF SAFETY

- ▶ Configurable control systems PNOZmulti 2

This document is a translation of the original document.

All rights to this documentation are reserved by Pilz GmbH & Co. KG. Copies may be made for internal purposes. Suggestions and comments for improving this documentation will be gratefully received.

Source code from third-party manufacturers or open source software has been used for some components. The relevant licence information is available on the Internet on the Pilz homepage.

Pilz®, PIT®, PMI®, PNOZ®, Primo®, PSEN®, PSS®, PVIS®, SafetyBUS p®, SafetyEYE®, SafetyNET p®, the spirit of safety® are registered and protected trademarks of Pilz GmbH & Co. KG in some countries.



SD means Secure Digital

Section 1	Introduction	5
	1.1 Validity of documentation	5
	1.2 Using the documentation	5
	1.3 Definition of symbols	5
Section 2	Overview	7
	2.1 Scope of supply	7
	2.2 Unit features	7
	2.3 Front view	8
Section 3	Safety	9
	3.1 Intended use	9
	3.2 System requirements	9
	3.3 Safety regulations	9
	3.3.1 Safety assessment	9
	3.3.2 Use of qualified personnel	10
	3.3.3 Warranty and liability	10
	3.3.4 Disposal	10
	3.3.5 For your safety	10
Section 4	Function description	11
	4.1 Integrated protection mechanisms	11
	4.2 Functions	11
	4.3 System reaction time	11
	4.4 Block diagram	11
Section 5	Installation	12
	5.1 General installation guidelines	12
	5.2 Dimensions in mm	12
	5.3 Connecting the base unit and expansion modules	12
Section 6	Commissioning	14
	6.1 General wiring guidelines	14
	6.2 Connection	14
	6.3 Download modified project to the PNOZmulti system	15
Section 7	Operation	16
	7.1 Messages	16
Section 8	Technical details	17
	8.1 Safety characteristic data	20
Section 9	Supplementary data	21
	9.1 Service life graph for the relay contacts	21
	9.2 Permitted ambient temperature T_{amb} dependent on the total current I_{sum}	23

Section 10	Order reference	24
	10.1 Product	24
	10.2 Accessories	24

1 Introduction

1.1 Validity of documentation

This documentation is valid for the product PNOZ m EF 4DI4DOR. It is valid until new documentation is published.

This operating manual explains the function and operation, describes the installation and provides guidelines on how to connect the product.

1.2 Using the documentation

This document is intended for instruction. Only install and commission the product if you have read and understood this document. The document should be retained for future reference.

1.3 Definition of symbols

Information that is particularly important is identified as follows:



DANGER!

This warning must be heeded! It warns of a hazardous situation that poses an immediate threat of serious injury and death and indicates preventive measures that can be taken.



WARNING!

This warning must be heeded! It warns of a hazardous situation that could lead to serious injury and death and indicates preventive measures that can be taken.



CAUTION!

This refers to a hazard that can lead to a less serious or minor injury plus material damage, and also provides information on preventive measures that can be taken.



NOTICE

This describes a situation in which the product or devices could be damaged and also provides information on preventive measures that can be taken. It also highlights areas within the text that are of particular importance.

**INFORMATION**

This gives advice on applications and provides information on special features.

2 Overview

2.1 Scope of supply

- ▶ Expansion module PNOZ m EF 4DI4DOR
- ▶ Jumper

2.2 Unit features

Using the product PNOZ m EF 4DI4DOR:

Expansion module for connection to a base unit from the configurable control system PNOZmulti 2 .

The product has the following features:

- ▶ Can be configured in the PNOZmulti Configurator
- ▶ Positive-guided relay outputs:
 - 4 safety outputs
 - Depending on the application, up to PL e of EN ISO 13849-1 and up to SIL CL 3 of EN IEC 62061
- ▶ 4 inputs for connecting, for example:
 - E-STOP pushbutton
 - Two-hand button
 - Safety gate limit switch
 - Start button
 - Light beam devices
 - Scanner
 - Enabling switch
 - PSEN
 - Operating mode selector switch
- ▶ LED for:
 - Error messages
 - Diagnostics
 - Supply voltage
 - Output circuits
 - Input circuits
- ▶ Test pulse outputs used to monitor shorts across the inputs
- ▶ Monitoring of shorts between the safety outputs
- ▶ Plug-in connection terminals:
 - Either spring-loaded terminal or screw terminal available as an accessory (see order reference)
- ▶ Please refer to the document "PNOZmulti System Expansion" for the PNOZmulti base units that can be connected.

2.3 Front view

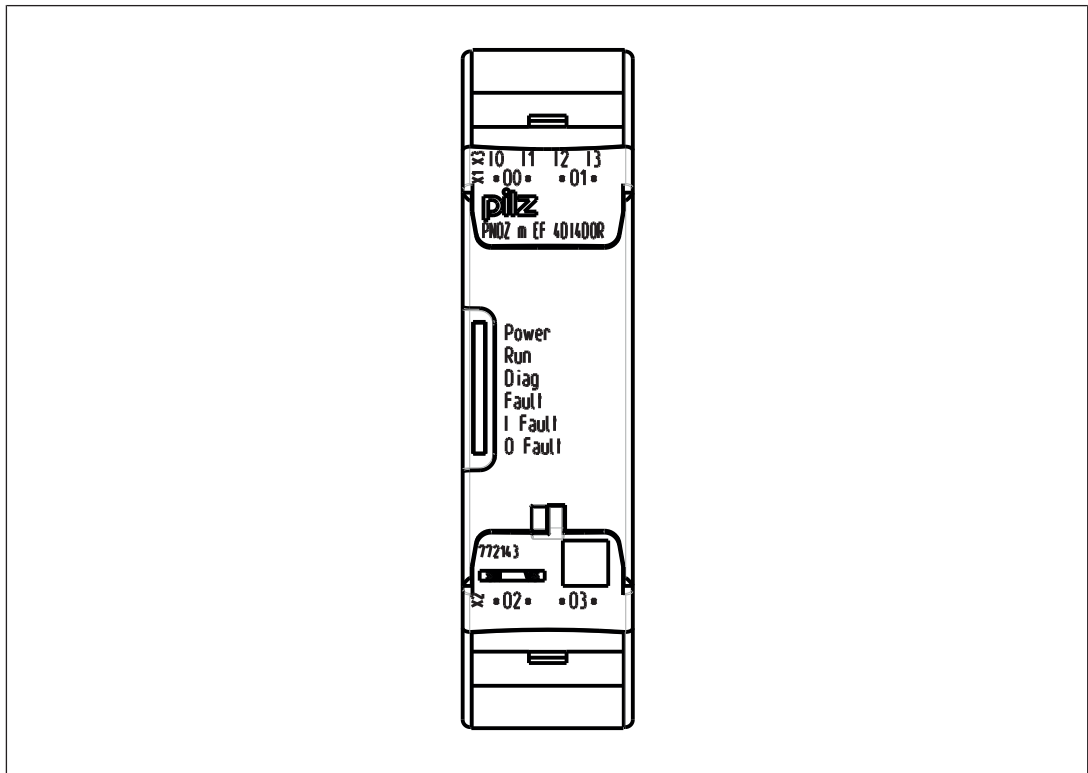

Legend:

- ▶ Inputs I0 – I3
- ▶ Outputs O0 – O3
- ▶ LEDs:
 - POWER
 - Run
 - Diag
 - Fault
 - I Fault
 - O Fault

3 Safety

3.1 Intended use

The expansion module may only be connected to a base unit from the configurable system PNOZmulti 2 (please refer to the document "PNOZmulti System Expansion" for details of the base units that can be connected).

The configurable system PNOZmulti 2 is used for the safety-related interruption of safety circuits and is designed for use in:

- ▶ Emergency stop equipment
- ▶ Safety circuits in accordance with VDE 0113 Part 1 and EN 60204-1

The following is deemed improper use in particular:

- ▶ Any component, technical or electrical modification to the product
- ▶ Use of the product outside the areas described in this manual
- ▶ Use of the product outside the technical details (see [Technical details](#) [ 17]).



NOTICE

EMC-compliant electrical installation

The product is designed for use in an industrial environment. The product may cause interference if installed in other environments. If installed in other environments, measures should be taken to comply with the applicable standards and directives for the respective installation site with regard to interference.

3.2 System requirements

Please refer to the "Product Modifications PNOZmulti" document in the "Version overview" section for details of which versions of the base unit and PNOZmulti Configurator can be used for this product.

3.3 Safety regulations

3.3.1 Safety assessment

Before using a unit it is necessary to perform a safety assessment in accordance with the Machinery Directive.

Functional safety is guaranteed for the product as a single component. However, this does not guarantee the functional safety of the overall plant/machine. In order to achieve the required safety level for the overall plant/machine, define the safety requirements for the plant/machine and then define how these must be implemented from a technical and organisational standpoint.

3.3.2 Use of qualified personnel

The products may only be assembled, installed, programmed, commissioned, operated, maintained and decommissioned by competent persons.

A competent person is someone who, because of their training, experience and current professional activity, has the specialist knowledge required to test, assess and operate the work equipment, devices, systems, plant and machinery in accordance with the general standards and guidelines for safety technology.

It is the company's responsibility only to employ personnel who:

- ▶ Are familiar with the basic regulations concerning health and safety / accident prevention
- ▶ Have read and understood the information provided in this description under "Safety"
- ▶ And have a good knowledge of the generic and specialist standards applicable to the specific application.

3.3.3 Warranty and liability

All claims to warranty and liability will be rendered invalid if

- ▶ The product was used contrary to the purpose for which it is intended
- ▶ Damage can be attributed to not having followed the guidelines in the manual
- ▶ Operating personnel are not suitably qualified
- ▶ Any type of modification has been made (e.g. exchanging components on the PCB boards, soldering work etc.).

3.3.4 Disposal

- ▶ In safety-related applications, please comply with the mission time T_M in the safety-related characteristic data.
- ▶ When decommissioning, please comply with local regulations regarding the disposal of electronic devices (e.g. Electrical and Electronic Equipment Act).

3.3.5 For your safety

The unit meets all the necessary conditions for safe operation. However, you should always ensure that the following safety requirements are met:

- ▶ This operating manual only describes the basic functions of the unit. The expanded functions are described in the PNOZmulti Configurator's online help. Only use these functions once you have read and understood the documentations.
- ▶ Do not open the housing or make any unauthorised modifications.
- ▶ Please make sure you shut down the supply voltage when performing maintenance work (e.g. exchanging contactors).

4 Function description

4.1 Integrated protection mechanisms

The relay conforms to the following safety criteria:

- ▶ The circuit is redundant with built-in self-monitoring.
- ▶ The safety function remains effective in the case of a component failure.
- ▶ The relay contacts meet the requirements for protective separation through increased insulation compared with all other circuits in the safety system.

4.2 Functions

The expansion module provides additional inputs and additional relay outputs.

The function of the inputs and outputs on the control system depends on the safety circuit created using the PNOZmulti Configurator. A chip card is used to download the safety circuit to the base unit. The base unit has 2 microcontrollers that monitor each other. They evaluate the input circuits on the base unit and expansion modules and switch the outputs on the base unit and expansion modules accordingly.

The online help on the PNOZmulti Configurator contains descriptions of the operating modes and all the functions of the PNOZmulti control system, plus connection examples.

4.3 System reaction time

Calculation of the maximum reaction time between an input switching off and a linked output in the system switching off is described in the document "PNOZmulti System Expansion".

4.4 Block diagram

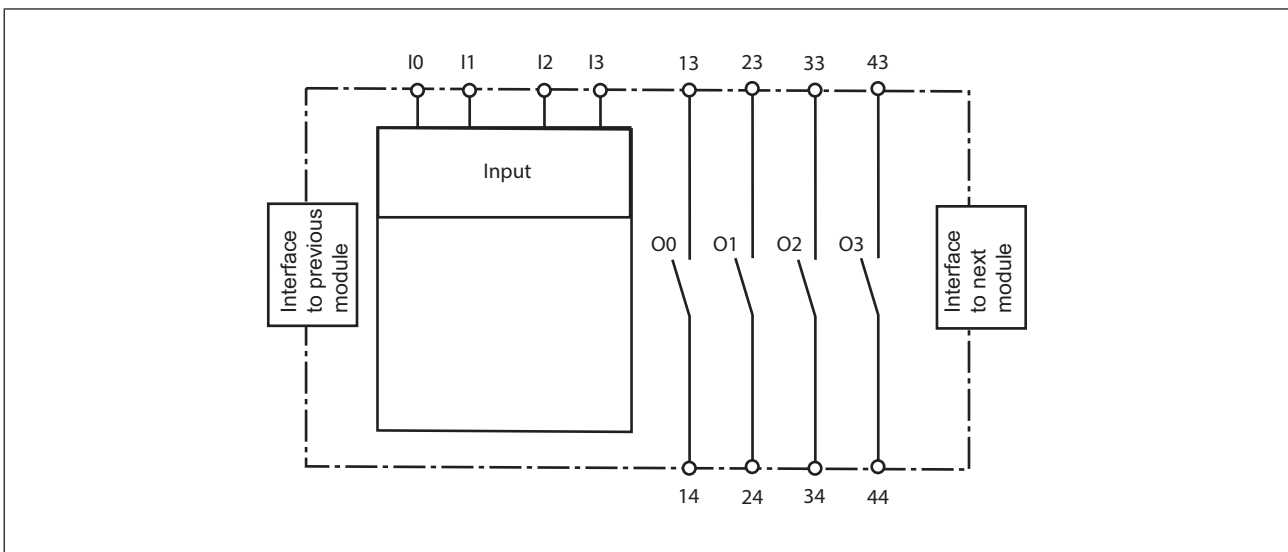

5 Installation

5.1 General installation guidelines

- ▶ The unit should be installed in a control cabinet with a protection type of at least IP54.
- ▶ Fit the safety system to a horizontal mounting rail. The venting slots must face upward and downward. Other mounting positions could damage the safety system.
- ▶ Use the locking elements on the rear of the unit to attach it to a mounting rail.
- ▶ In environments exposed to heavy vibration, the unit should be secured using a fixing element (e.g. retaining bracket or end angle).
- ▶ Open the locking slide before lifting the unit from the mounting rail.
- ▶ To comply with EMC requirements, the mounting rail must have a low impedance connection to the control cabinet housing.
- ▶ The ambient temperature of the PNOZmulti units in the control cabinet must not exceed the figure stated in the technical details, otherwise air conditioning will be required.



NOTICE

Damage due to electrostatic discharge!

Electrostatic discharge can damage components. Ensure against discharge before touching the product, e.g. by touching an earthed, conductive surface or by wearing an earthed armband.

5.2 Dimensions in mm

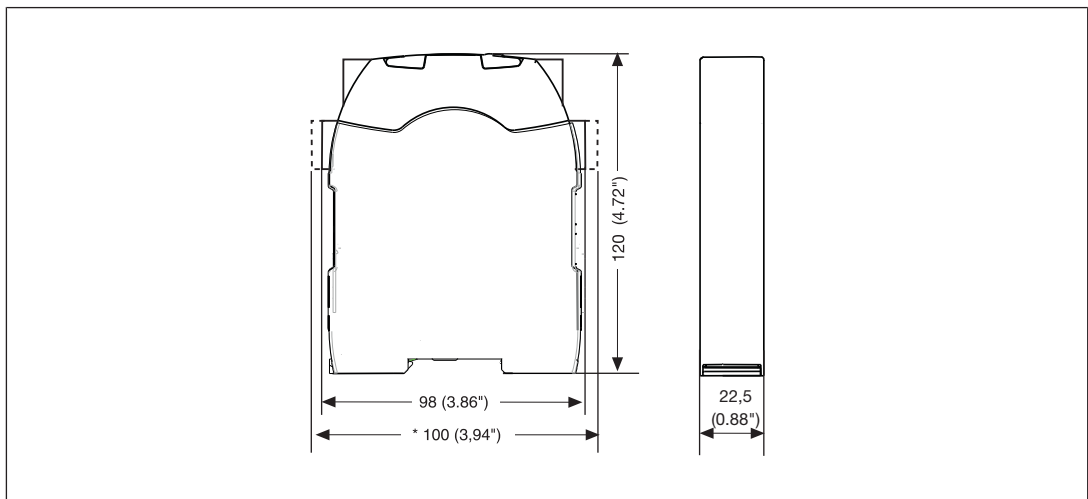

5.3 Connecting the base unit and expansion modules

Connect the base unit and the expansion modules as described in the operating manuals for the base modules.

- ▶ The terminator must be fitted to the last expansion module
- ▶ Install the expansion module in the position configured in the PNOZmulti Configurator.

The position of the expansion modules is defined in the PNOZmulti Configurator. The expansion modules are connected to the left or right of the base unit, depending on the type. Please refer to the document "PNOZmulti System Expansion" for details of the number of modules that can be connected to the base unit and the module types.

6 Commissioning

6.1 General wiring guidelines

The wiring is defined in the circuit diagram of the PNOZmulti Configurator.

Please note:

- ▶ Information given in the [Technical details](#) [17] must be followed.
- ▶ Use copper wire that can withstand 75° C.

6.2 Connection

Input circuit	Single-channel	Dual-channel
Example: E-Stop without detection of shorts across contacts		
Example: E-Stop with detection of shorts across contacts		
Relay outputs		
Dual output		
Single output		

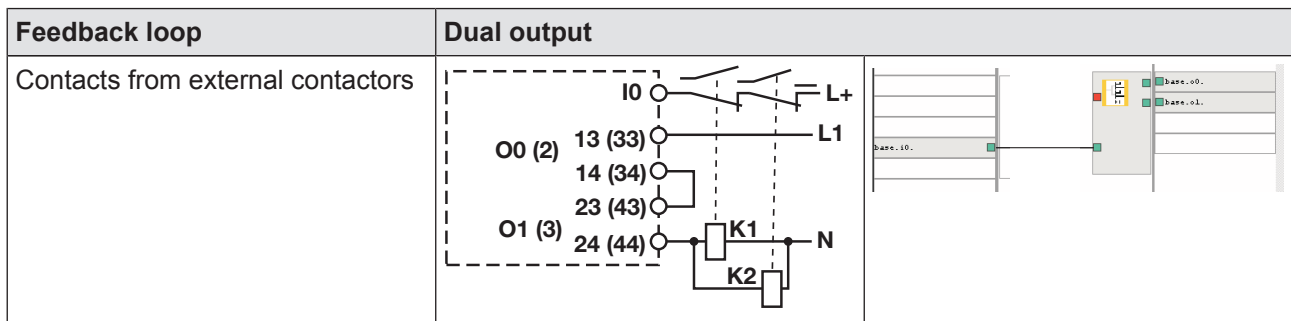

6.3 Download modified project to the PNOZmulti system

As soon as an additional expansion module has been connected to the system, the project must be amended using the PNOZmulti Configurator. Proceed as described in the operating instructions for the base unit.



NOTICE

For the commissioning and after every program change, you must check whether the safety devices are functioning correctly.



7 Operation

















When the supply voltage is switched on, the PNOZmulti safety system copies the configuration from the chip card.

The LEDs "POWER", "DIAG", "FAULT", "IFAUULT" and "OFAULT" will light up on the base unit.

7.1 Messages

Legend

-  LED on
-  LED flashes
-  LED off

LED						Error
POWER	Run	Diag	Fault	IFault	OFault	
						No supply voltage
						Expansion module PNOZ m EF 4DI4DOR running without error.
						Expansion module PNOZ m EF 4DI4DOR is in a STOP condition.
						Internal error on the expansion module PNOZ m EF 4DI4DOR or on the overall system. Expansion module is in a safe condition.
						External error on the expansion module PNOZ m EF 4DI4DOR or on the overall system. Expansion module is in a safe condition.
						Internal error on the inputs of the expansion module PNOZ m EF 4DI4DOR. Expansion module is in a safe condition, e.g. pulse error.
						Internal error on the outputs of the expansion module PNOZ m EF 4DI4DOR. Expansion module is in a safe condition.
						External error on the inputs of the expansion module PNOZ m EF 4DI4DOR. Expansion module is in a safe condition.
						External error on the outputs of the expansion module PNOZ m EF 4DI4DOR. Expansion module is in a safe condition, e.g. defective feedback loop.

8 Technical details

General	
Approvals	BG, CCC, CE, GOST, TÜV, cULus Listed
Application range	Failsafe
Module's device code	00E1h
Electrical data	
Supply voltage	
for	Module supply
internal	Via base unit
Voltage	24,0 V
Kind	DC
Current consumption	122 mA
Power consumption	3,0 W
Max. power dissipation of module	6,50 W
Status indicator	LED
Permitted loads	inductive, resistive
Inputs	
Number	4
Input voltage in accordance with EN 61131-2 Type 1	24 V DC
Input current at rated voltage	5 mA
Input current range	2,5 - 5,3 mA
Pulse suppression	0,5 ms
Maximum input delay	8 ms
Potential isolation	No
Relay outputs	
Utilisation category	
In accordance with the standard	EN 60947-4-1
Utilisation category of safety contacts	
AC1 at	250 V
Min. current	10,00 mA
Max. current	6,0 A
Max. power	1500 VA
DC1 at	24 V
Min. current	10,00 mA
Max. current	6,0 A
Max. power	144 W
Utilisation category	
In accordance with the standard	EN 60947-5-1

Relay outputs	
Utilisation category of safety contacts	
AC15 at	230 V
Max. current	3,0 A
Max. power	690 W
DC13 (6 cycles/min) at	24 V
Max. current	3,0 A
Max. power	72 W
Utilisation category in accordance with UL	
Voltage	240 V AC G.U. Resistive
With current	6,0 A
Voltage	24 V DC G. U. Resistive
With current	6,0 A
Pilot Duty; R300	24 V DC
With current	3,0 A
Pilot Duty; B300	230 V AC
With current	3,0 A
Airgap creepage between	
Relay contacts	3 mm
Relay contacts and other circuits	5,5 mm
External contact fuse protection, safety contacts	
In accordance with the standard	VDE 0660
Blow-out fuse, quick	10 A
Blow-out fuse, slow	6 A
Switch-off delay	22 ms
Contact material	AgCuNi + 0,2 µm Au
Potential isolation	yes
Environmental data	
Ambient temperature	
In accordance with the standard	EN 60068-2-14
Temperature range	0 - 60 °C
Forced convection in control cabinet off	55 °C
Storage temperature	
In accordance with the standard	EN 60068-2-1/-2
Temperature range	-25 - 70 °C
Climatic suitability	
In accordance with the standard	EN 60068-2-30, EN 60068-2-78
Condensation during operation	Not permitted
EMC	EN 61131-2
Vibration	
In accordance with the standard	EN 60068-2-6
Frequency	5,0 - 150,0 Hz
Acceleration	1g

Environmental data	
Shock stress	
In accordance with the standard	EN 60068-2-27
Acceleration	15g
Duration	11 ms
Max. operating height above sea level	2000 m
Airgap creepage	
In accordance with the standard	EN 61131-2
Overvoltage category	II
Rated insulation voltage	30 V
Protection type	
In accordance with the standard	EN 60529
Mounting area (e.g. control cabinet)	IP54
Housing	IP20
Terminals	IP20
Mechanical data	
Mounting position	Horizontal on top hat rail
Mechanical life	10,000,000 cycles
DIN rail	
Top hat rail	35 x 7,5 EN 50022
Recess width	27 mm
Max. cable length	
Max. cable length per input	1,0 km
Material	
Bottom	PC
Front	PC
Top	PC
Connection type	Spring-loaded terminal, screw terminal
Mounting type	plug-in
Conductor cross section with screw terminals	
1 core flexible	0,25 - 2,50 mm², 24 - 12 AWG
2 core with the same cross section, flexible without crimp connectors or with TWIN crimp connectors	0,20 - 1,50 mm², 24 - 16 AWG
Torque setting with screw terminals	0,50 Nm
Conductor cross section with spring-loaded terminals:	
Flexible with/without crimp connector	0,20 - 2,50 mm², 24 - 12 AWG
Spring-loaded terminals: Terminal points per connection	2
Stripping length with spring-loaded terminals	9 mm
Dimensions	
Height	101,4 mm
Width	22,5 mm
Depth	120,0 mm
Weight	190 g

Where standards are undated, the 2012-04 latest editions shall apply.

8.1 Safety characteristic data



NOTICE

You must comply with the safety-related characteristic data in order to achieve the required safety level for your plant/machine.

Unit	Operating mode	EN ISO 13849-1: 2008 PL	EN ISO 13849-1: 2008 Category	EN 62061 SIL CL	EN 62061 PFH _D [1/h]	EN ISO 13849-1: 2008 T _M [year]
Logic						
CPU	–	PL e	Cat. 4	SIL CL 3	2,84E-10	20
Input						
SC inputs	1-channel	PL d	Cat. 2	SIL CL 2	2,10E-09	20
SC inputs	2-channel	PL e	Cat. 4	SIL CL 3	4,27E-11	20
SC inputs	1-ch., pulsed light barrier	PL e	Cat. 4	SIL CL 3	2,10E-10	20
Output						
Relay outputs	1-channel	PL c	Cat. 1	-	3,75E-08	20
Relay outputs	2-channel	PL e	Cat. 4	SIL CL 3	7,52E-12	20

All the units used within a safety function must be considered when calculating the safety characteristic data.



INFORMATION

A safety function's SIL/PL values are **not** identical to the SIL/PL values of the units that are used and may be different. We recommend that you use the PAScal software tool to calculate the safety function's SIL/PL values.



CAUTION!

It is essential to consider the relay's service life graphs. The relay outputs' safety-related characteristic data is only valid if the values in the service life graphs are met.

The PFH value depends on the switching frequency and the load on the relay output. If the service life graphs are not accessible, the stated PFH value can be used irrespective of the switching frequency and the load, as the PFH value already considers the relay's B10d value as well as the failure rates of the other components.

9 Supplementary data

9.1 Service life graph for the relay contacts

The service life graphs indicate the number of cycles from which failures due to wear must be expected. The wear is mainly caused by the electrical load; the mechanical load is negligible.

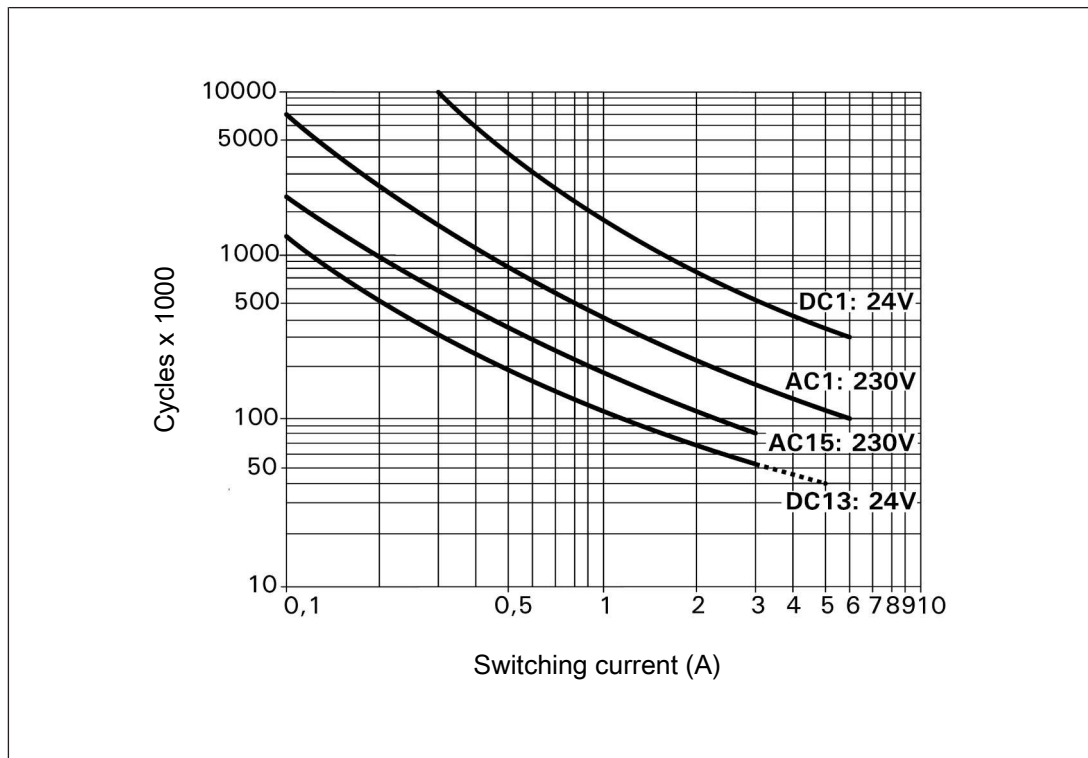

Fig.: Service life graphs at 24 VDC and 230 VAC

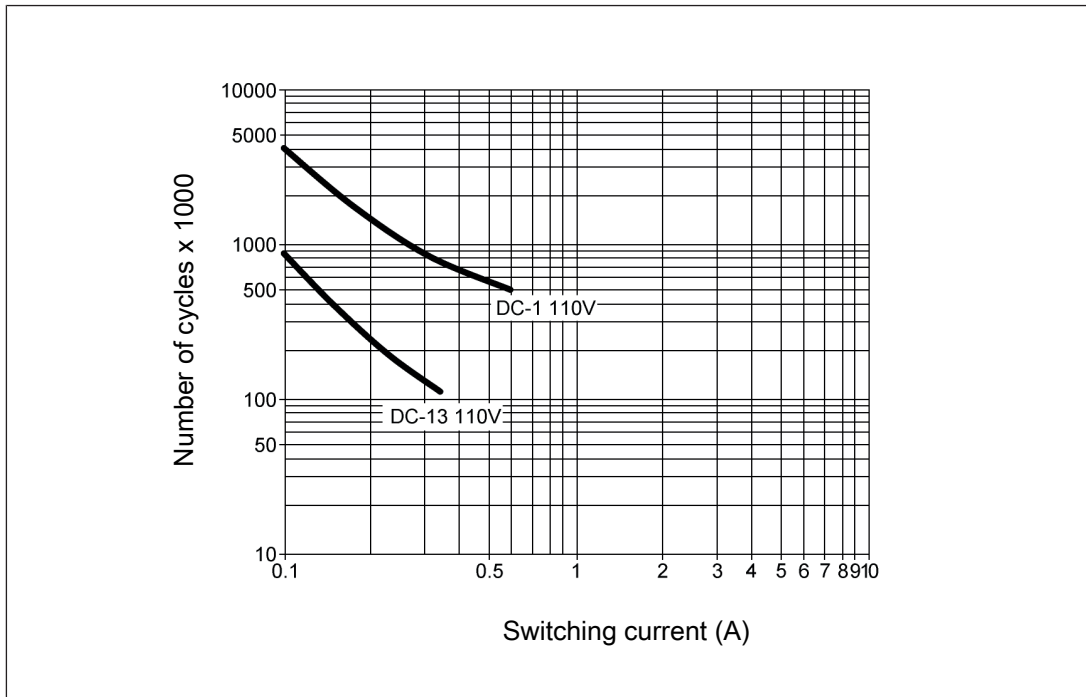

Fig.: Service life graphs at 110 VDC

Example

- ▶ Inductive load: 0.2 A
- ▶ Utilisation category: AC15
- ▶ Contact service life: 1 000 000 cycles

Provided the application to be implemented requires fewer than 1 000 000 cycles, the PFH value (see [Technical details \[17\]](#)) can be used in the calculation.

To increase the service life, sufficient spark suppression must be provided on all relay contacts. With capacitive loads, any power surges that occur must be noted. With DC contactors, use flywheel diodes for spark suppression.

We recommend you use semiconductor outputs to switch 24 VDC loads.

9.2 Permitted ambient temperature T_{amb} dependent on the total current I_{sum}

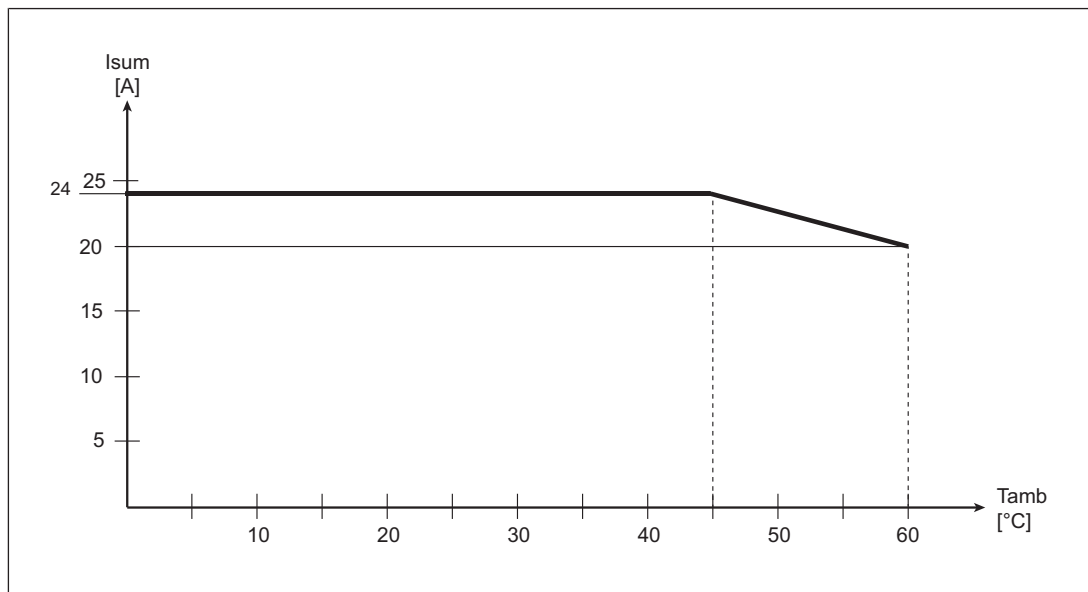

Max. permitted total current of relay outputs at an ambient temperature of < 45 °C: 24 A

Max. permitted total current of relay outputs at an ambient temperature of = 60 °C: 20 A

10 Order reference

10.1 Product

Product type	Features	Order No.
PNOZ m EF 4DI4DOR	Expansion module	772 143

10.2 Accessories

Connection terminals

Product type	Features	Order No.
Set spring terminals	1 set of spring-loaded terminals	751 004
Set screw terminals	1 set of screw terminals	750 004

Terminator, jumper

Product type	Features	Order No.
PNOZ mm0.xp connector left	Jumper yellow/black to connect the modules, 10 piece	779 260

► Support

Technical support is available from Pilz round the clock.

Americas

Brazil
+55 11 97569-2804

Canada
+1 888-315-PILZ (315-7459)

Mexico
+52 55 5572 1300

USA (toll-free)
+1 877-PILZUSA (745-9872)

Asia

China
+86 21 60880878-216

Japan
+81 45 471-2281

South Korea
+82 31 450 0680

Australia

+61 3 95446300

Europe

Austria
+43 1 7986263-0

Belgium, Luxembourg
+32 9 3217575

France
+33 3 88104000

Germany
+49 711 3409-444

Ireland
+353 21 4804983

Italy
+39 0362 1826711

Scandinavia

+45 74436332

Spain

+34 938497433

Switzerland

+41 62 88979-30

The Netherlands

+31 347 320477

Turkey

+90 216 5775552

United Kingdom

+44 1536 462203

You can reach our international hotline on:

+49 711 3409-444
support@pilz.com

Pilz develops environmentally-friendly products using ecological materials and energy-saving technologies. Offices and production facilities are ecologically designed, environmentally-aware and energy-saving. So Pilz offers sustainability, plus the security of using energy-efficient products and environmentally-friendly solutions.



Pilz GmbH & Co. KG
Felix-Wankel-Straße 2
73760 Ostfildern, Germany
Tel.: +49 711 3409-0
Fax: +49 711 3409-133
info@pilz.com
www.pilz.com



X-ON Electronics

Largest Supplier of Electrical and Electronic Components

Click to view similar products for [pilz manufacturer](#):

Other Similar products are found below :

[774056](#) [750101](#) [750107](#) [750109](#) [774738](#) [774314](#) [503221](#) [750105](#) [750106](#) [773400](#) [773500](#) [773732](#) [774316](#) [774340](#) [774350](#) [777601](#)
[777760](#) [787587](#) [PNOZ M B0](#) [750004](#) [783542](#) [PNOZ M ES PROFIBUS](#) [772100](#) [774585](#) [774060](#) [774131](#) [751107](#) [750154](#) [750134](#) [750102](#)
[750126](#) [774-314](#) [PNOZ/X3/110V24V](#) [506320](#) [506345](#) [570520](#) [773100](#) [774709](#) [506220](#) [750108](#) [750110](#) [774325](#) [774540](#) [777305](#) [774130](#)
[774076](#) [777301](#) [750167](#) [506326](#) [751105](#) [774500](#)