

Voice/Data/Video Tools, Testors & Connectors

Our comprehensive line of verification VDV products was created to prep, connect and test network, phone, CATV, home theater, satellite, and security cables for residential or commercial systems.



For Professionals...
Since 1857™

Coaxial Cutting Tool

Coaxial Cable Cutter - CCS

- Multi-functional blade optimized to cut copper-clad steel (CCS) coaxial cable and other common wires or cables
- Forged from custom, US-made steel and through-hardened, the specialized notched blade is designed to withstand steel cable cutting
- Notched blade section is optimized to easily cut common CCS coaxial cables such as RG-59, RG-6/6Q, RG-7 and RG-11
- Shears blade section is designed to cleanly cut and snip solid and stranded copper, aluminum, UTP/STP twisted pair wires and cables
- Blade geometry ensures CCS coaxial cable retains form when cut to facilitate easy insertion into connectors and provide excellent terminations
- High-leverage handles for genuine one-handed operation
- Handles are plastic-coated for maximum comfort and grip



VDV600-096

Cat. No.	Handle Color	Cutting Knives	Cuts	Handle Type	Overall Length	Weight
VDV600-096	Yellow	Custom Notch for CCS Coaxial Cable Standard Shears for General Purpose	RG59, RG6, RG6Q, RG7, RG11 Twisted Pair	Plastic Dipped	7-5/8" (193.7 mm)	8.4 oz. (238 g)

Radial Strippers

Radial Stripper UTP/STP

- One-step outer jacket stripping, 1-level of category 3, 5, 5e, 6, and 6a cables
- Durable high-carbon steel cutting blades are ground and honed for long life
- Removes the outer jacket of twisted pair cable without damaging the conductors
- Strip and slit lengths may be varied to accommodate different connector requirements
- Recessed cutting surface slits long runs of twisted-pair cable
- Multiple nest cavities allow the removal of a wide variety of jacket materials on twisted-pair cable
- Tension loop can be disengaged for thin-jacket cable
- One-piece construction ensures alignment for precise stripping
- Large finger loop promotes rotation during use
- Adjustable set-screw prevents twisted-pair conductor insulation scoring



VDV120-006

Cat. No.	Color	Strips or Slits	Levels	Strip/Slit Dimensions	Prepared Cable	Overall Length	Weight
VDV120-006-SEN	Yellow	Unshielded Twisted Pair; Shielded Twisted Pair	1	Varies by application		4-13/32" (111.9 mm)	1.3 oz. (37 g)

Coax Cable Radial Strippers - 2-Level

- Cat. No. VDV110-095 features two stripping cavities: one for standard size cable and one for utility size cables. Perfect for the data installer who works with utility cable as well standard cable
- Cat. No. VDV110-095 strips five different series of RG cable including: RG6, RG6-QS, RG59, RG11 and RG7
- 2-level stripping in one step - 5/16" and 1/4" (7.9 mm and 6.4 mm)
- Klein's sliding cable stop pre-measures cable for fast, accurate and repeatable strips
- Durable high-carbon steel cutting blades automatically adjust to different cable diameters
- Finger loop facilitates easy, controlled rotation
- Easy debris clean-out



VDV110-095



US Patent: D688927

VDV110-061

Cat. No.	Color	Levels	Cable	Cartridge Strip Dimensions	Prepared Cable	Overall Length	Weight
VDV110-095	Yellow/Gray	2	RG59, RG6, RG6-QS, RG7, RG11	0.3125" and 0.250" (7.94 and 6.35 mm)		5-1/4" (133.4 mm)	1.5 oz. (43 g)
VDV110-061	Yellow/Black	2	RG59, RG6, RG6-QS	0.3125" and 0.250" (7.94 and 6.35 mm)		4-19/32" (116.7 mm)	1.2 oz. (34 g)



Radial Strippers and Cartridges

Cartridge Radial Strippers

- Designed for high-volume, multiple-type cable preparation environments
- Includes storage cartridge-bay
- One-piece construction ensures precise stripping and never requires adjustment
- Large finger loop promotes rotation during use
- F-Connector "nest" assists with cable insertion
- Cartridges snap in from both sides for left or right-handed operation
- Durable high-carbon steel cartridge cutting blades are ground and honed for long life
- Additional and replacement cartridges available

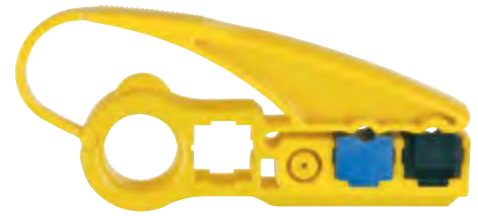

VDV100-801



VDV110-802

Cat. No.	Set Contains	Overall Length	Weight		
VDV100-801-SEN	Dual Cartridge Radial Stripper	5.6" (143 mm)	2.4 oz. (68 g)		
Cat. No.	Cable	Color	Levels	Cartridge Strip Dimensions	Prepared Cable
VDV110-003-SEN	RG59/RG6/RG6 QS Coaxial Cable	Black	2	0.3125" and 0.250" (7.94 and 6.35 mm)	
VDV120-005-SEN	UTP Cable (Category 3, 5, 5e and 6)	Blue	1	Variable	
Cat. No.	Set Contains	Overall Length	Weight		
VDV110-802-SEN	Radial Cartridge Stripper	5.2" (133 mm)	2.1 oz. (60 g)		
Cat. No.	Cable	Color	Levels	Cartridge Strip Dimensions	Prepared Cable
VDV110-003-SEN	RG59/RG6/RG6 QS Coaxial Cable	Black	2	0.3125" and 0.250" (7.94 and 6.35 mm)	

Radial Stripper Cartridges

- **Designed for use with:**
Dual Cartridge Radial Stripper (Cat. No. VDV100-801),
Radial Cartridge Stripper (Cat. Nos. VDV110-802)
- Pre-set cutting blades for precise, accurate and efficient cable stripping
- Durable high-carbon steel cutting blades are ground and honed for long life
- Patented "V" notch eliminates scoring of the center conductor*
- Color-coded for easy identification
- Meets industry standards established by the SCTE (Society of Cable Telecommunication Engineers)
- Cartridges made from glass filled polycarbonate for superior strength and extended durability



VDV110-003



VDV110-004



VDV110-020



VDV113-022



VDV113-021

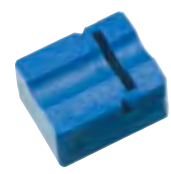

VDV120-005

Cat. No.	Cable	Color	Levels	Cartridge Strip Dimensions	Prepared Cable	Weight
VDV110-003-SEN	RG59/RG6/RG6 QS Coaxial Cable	Black	2	0.3125" and 0.250" (7.94 and 6.35 mm)		0.1 oz. (2.8 g)
VDV110-004-SEN	RG7/RG11 Coaxial Cable	Gray	2	0.3125" x 0.250" (7.94 x 6.35 mm)		0.1 oz. (2.8 g)
VDV120-005-SEN	UTP Cable (Category 3, 5, 5e and 6)	Blue	1	Variable		0.1 oz. (2.8 g)
VDV110-020	Mini Coaxial Cable	Green	2	0.250" x 0.250" (6.35 x 6.35 mm)		0.1 oz. (2.8 g)
VDV113-021	RG58/RG59/RG62 Coaxial Cable	Green	3	0.234" x 0.234" x Variable (5.95 x 5.95 mm x Variable)		0.1 oz. (2.8 g)
VDV113-022	RG58/RG59/RG62 Coaxial Cable	Brown	3	0.109" x 0.312" x Variable (2.76 mm x 7.92 mm x Variable)		0.1 oz. (2.8 g)

See page 310 for additional information on warnings.



Coaxial Connector Crimp Tools

Compression Crimper - Lateral, Multi-Connector

- One tool crimps most compression connectors to most coaxial cables - Minicoax, RG58, RG59, RG62, RG6, RG6QS, RG7, and RG11
- Unique cable selection wheel eliminates the need to change plunger tips, saving time and avoids losing parts
- Heavy-duty zinc die-cast chassis for durable, long lasting performance
- Open design with 180° capture mechanism provides easy insertion, complete compression and simple removal
- User-friendly F/BNC/RCA gauge markings on tool for accurate positioning and quick adjustments of the plunger
- Integrated handle lock for easy storage
- Spring loaded return increases user comfort and ease of use
- Yellow and black contoured grips enhance comfort, visibility and allow quick identification



VDV211-063



Connector markings for quick adjustments.

Cat. No.	Color	Type	Cable Type	Connectors	Overall Length	Weight
VDV211-063	Yellow/Black	Compression Crimper	Coaxial	BNC, F, RCA	6-1/4" (158.8 mm)	1.2 lbs. (0.54 kg)

Compression Crimper - Compact, Multi-Connector

- Fast, reliable multiple-type compression connector installations
- Crimps compression BNC, F and RCA connectors to coaxial cable
- Adjustable universal plunger ensures accurate crimps on multiple types of connectors
- Open design with 180° capture mechanism provides easy insertion, complete compression and simple removal of cable and connector
- User-friendly F/BNC/RCA gauge markings on tool for accurate positioning and quick adjustments of the plunger
- Compact tool with integrated handle lock for easy storage
- Spring loaded return increases user comfort and ease of use
- Yellow contoured grips enhance comfort, visibility and allow quick identification
- Steel body with chrome finish resists corrosion and extends tool life



VDV211-048



Connector markings for quick adjustments.

Cat. No.	Color	Type	Cable Type	Connectors	Overall Length	Weight
VDV211-048	Yellow/Chrome	Compression Crimper	Coaxial	BNC, F and RCA	5-19/32" (142.1 mm)	8.0 oz. (227 g)

Compact, F-Connector

- Fast, reliable F-connector installation tool
- Steel body with black-oxide finish for corrosion resistance and durability
- Fixed plunger allows quick, easy insertion and removal of cable and connector
- Fixed plunger accepts many common F-connector compression fittings
- Compact tool with integrated handle lock
- Yellow and black grips enhance comfort, visibility, and allow quick identification
- Spring loaded return increases user comfort and ease of use



VDV212-008

Cat. No.	Color	Type	Cable	Connectors	Overall Length	Weight
VDV212-008-SEN	Yellow/Black	Compression Crimper	Coaxial	Common F Connectors	5-19/32" (142.1 mm)	9.8 oz. (278 g)



Twisted Pair Crimp/Strip Tools

Compact Ratcheting Modular Crimper

- All-inclusive tool cuts, strips and crimps voice and data cables
- Cuts and strips CAT6, CAT5e, CAT3 and flat-satin voice cables
- Crimps 4, 6 and 8 position modular connectors
- Heavy-duty ratchet ensures complete termination
- Direct lateral crimp action provides more even, precise contact termination across all pins
- Compact, ergonomic design for natural, single-hand operation
- About 40% smaller than other crimpers for easy storage
- Quick reference connector wiring diagrams provided on the tool and downloadable to your mobile device



VDV226-107

Heavy-duty ratchet

Cat. No.	Color	Cuts & Strips	Crimps Connectors	Position/Pair/Conductors	Overall Length	Weight
VDV226-107	Yellow/Black	STP/UTP Data Cable Flat Satin Phone Cable 28 - 22 AWG (0.08 - 0.34 mm ²)	RJ11, RJ12 and RJ45	6-Position, 2-Pair/4-Conductor; 6-Position, 3-Pair/6-Conductor; 8-Position, 4-Pair/8-Conductor	5-1/4" (133.4 mm)	11.2 oz. (318 g)

Ratcheting Modular Crimper/Stripper

- Fast, reliable modular-crimp connector installation for voice and data applications
- All-in-one tool, cuts, strips and crimps paired-conductor cables (round STP/UTP and flat-satin phone cable)
- Crimps 4, 6, and 8 position modular connectors (RJ22, RJ11/RJ12 and RJ45)
- Crimping dies are precision ground from high-carbon steel
- Ratchet safety-release and a blade-guard on cutting and stripping knives reduce risk of injury
- Full-cycle ratchet mechanism prevents the release of the connector prior to full compression
- Yellow and black grips enhance comfort, visibility, and allow quick identification
- Not for use with AMP® connectors
- Replacement blade set available (Cat. No. VDV999-064)



VDV226-011

Cat. No.	Color	Cuts & Strips	Crimps Connectors	Position/Pair/Conductors	Overall Length	Weight
VDV226-011-SEN	Yellow/Black	STP/UTP, Flat Satin Phone Cable, and 22-28 AWG (0.08 - 0.34 mm ²)	RJ11, RJ12, RJ22, and RJ45	4-Position, 1-Pair/2-Conductor, 4-Position, 2-Pair/4-Conductor 6-Position, 2-Pair/4-Conductor, 6-Position, 3-Pair/6-Conductor, 8-Position, 4-Pair/8-Conductor	7-1/2" (190.5 mm)	11.3 oz. (320 g)

AMP® is a registered trademark of TYCO, Inc.

Long-Nose Pliers - Connector Crimping

- Crimps UR/UY/UG insulation displacement connectors (IDC) - Scotchlok® type connectors
- Grooved jaws for wire wrapping, looping and twisting
- Cleanly strips 23 AWG and 24 AWG wire
- Hot-riveted joint ensures smooth action and no handle wobble
- Induction-hardened cutting surface for long life

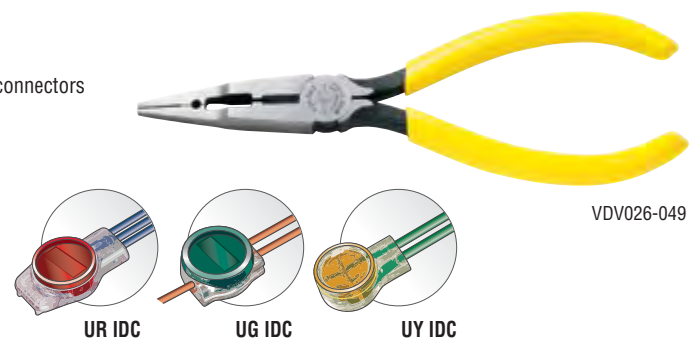

VDV026-049

Cat. No.	Overall Length	Jaw Length	Jaw Width	Jaw Thickness	Knife Length	Point Diameter	Handle Finish	Handle Color	Weight
VDV026-049	6-51/64" (172.6 mm)	2" (50.8 mm)	45/64" (17.9 mm)	3/8" (9.5 mm)	7/16" (11.1 mm)	0.095" x 0.125" (2.41 mm x 3.17 mm)	Plastic Dipped	Yellow	4.5 oz. (128 g)

Scotchlok® is a registered trademark of 3M Corporation.

See page 310 for additional information on warnings.



Punchdown Tools & Accesories

Punchdown Screwdriver Multi-Tool

- Terminate and cut wire in one step with 110/66 combination cut-type punchdown blade with precision ground cutting edge
- Non-impact wire termination
- Machine-tooled steel bits for superior strength
- Heavy-duty blade barrel provides storage for bits
- Bayonet-style (twist & lock) socket accepts most manufacturers' punchdown blades
- Cushion-Grip handle for greater torque and enhanced comfort
- Tip-Ident™ for quick identification of tool
- Two Phillips screwdriver tips: #1 and #2
- Two slotted screwdriver tips: 3/16" and 1/4"
- Two nut drivers: 1/4" and 3/8"
- One hex key: 3/8"

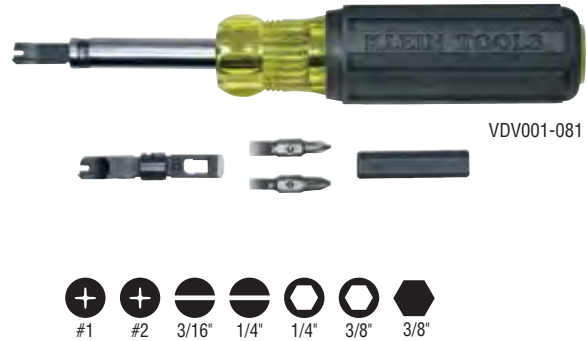

US Patent: 8856994

Cat. No.	Color	Included Bits/Blades	Finish	Overall Length	Weight
VDV001-081	Yellow/Black	66/110 Terminate and Cut, #1 and #2 Phillips, 3/16" (4.8 mm) and 1/4" (6.4 mm) Slotted, 1/4" and 3/8" Nut Driver, 3/8" Hex-Key	Chrome	8" (203.2 mm)	9.4 oz. (266 g)

Cushion-Grip Impact Punchdown Tools

- 4-piece tool kit for complete termination of 110/66 panels, cross-connect systems and wall jacks
- Cushion-Grip Impact Punchdown Tool (VDV427-821) includes a "Hi/Lo" impact functionality for adjustable compression force on various wire gauges, blocks and jacks
- The punchdown tool also has an integrated, extra-long shaft for reaching into bulky/crowded blocks and a heavy-duty metal collar for strength and longevity
- A unique Cushion-Grip handle reduces hand fatigue and provides superior comfort when using the punchdown tool
- Pick-up, separate or remove wires, small components, covers or debris from panels, blocks or jacks with the Wire Pick (VDV327-103)
- The Wire Pick body is made of non-conductive material to prevent shorts. It also has a metal hook end and a non conductive spudger end
- The Dura-Blade 110/66 Cut Combination Punchdown Blade (VDV427-104) is manufactured using a metal injecting molding (MIM) technology for better quality, durability and performance
- The blade has both 110 and 66 cut/terminate edges for clean, accurate wire insertion and trimming. It is compatible with most bayonet style (twist & lock) socket punchdown tools
- The kit-exclusive Multi-Pocket Pouch has separate compartments to store tools, a metal belt clip and a reinforced puncture-resistant bottom



US Patent: D718585

Cat. No.	Set Contains	Overall Length	Weight
VDV427-822		9.125" (232 mm)	14.9 oz. (422 g)
Cat. No.	Description	Blade Configuration End 1	Blade Configuration End 2
VDV427-821	Cushion-Grip Impact Punchdown Tool w/Dura-Blade™	110 Terminate and Cut	66 Terminate and Cut
VDV327-103	Wire Pick	Hook	Spudger
VDV427-104	Dura-Blade™ 110/66 Cut Punchdown Blade	110 Terminate and Cut	66 Terminate and Cut
kit exclusive	Multi-pocket pouch with reinforced puncture-resistant bottom		

*Items also sold separately





Punchdown Tools & Accessories

Punchdown Multi-Tool with 110/66 Blade

- Patented locking impact mechanism allows non-impact operation and sure driving with a variety of optional WorkEnds™ driver bits
- Terminate and cut wire in one step with included precision ground combination 110/66 blade
- Integrated hook and spudger for fast, easy manipulation of wire and small components
- Selectable (Hi/Low) impact-force settings
- Spring loaded for fast, low effort seating and terminating
- Dual material contoured chassis provides greater control and enhances comfort
- Blade storage compartment with spring loaded locking mechanism
- Color-coded yellow on the cut side of the tool
- Hook and spudger neatly and compactly store in the chassis, out of the way when not in use
- Induction-hardened high-carbon steel for durability and long life
- Cat. No. VDV427-807 Includes WorkEnds™ Kit with WorkEnds™ adapter, reach extension, and 4 driver bits (#1 and #2 Phillips and 3/16" and 1/4" Slotted) in a convenient carrier
- Replacement blades/accessories available



VDV427-807



Cat. No.	Set Contains	Overall Length	Weight
VDV427-807	Punchdown Multi-Tool with 110/66 Blade & WorkEnds	7.88" (200 mm)	7.5 oz. (213 g)
Cat. No.	Color	Blade Configuration End 1	Blade Configuration End 2
VDV427-104	Chrome	110 Terminate and Cut	66 Terminate and Cut
VDV770-050	—	Proprietary Magnetic Hex	1/4" Female Hex

Impact Punchdown Tools

- Terminate cable in variety of cross-connect panels, blocks and keystone jacks
- Spring loaded for fast, low effort seating and terminating
- Selectable (Hi/Low) impact-force settings
- Rubber finger grips and boot provide greater control and enhanced comfort
- Blade storage compartment with spring loaded locking mechanism
- Bayonet style (twist & lock) socket accepts most manufacturers' tools and blades
- Induction-hardened high-carbon steel for durability and long life
- Replacement blades available



VDV427-800



VDV427-104



VDV427-015-SEN

Cat. No.	Set Contains	Overall Length	Weight
VDV427-800-SEN	Impact Punchdown Tool, Combo 66/110 Type	7" (177 mm)	5.7 oz. (162 g)
Cat. No.	Color	Blade Configuration End 1	Blade Configuration End 2
VDV427-013	Yellow/Black	—	—
VDV427-104	Chrome	110 Terminate and Cut	66 Terminate and Cut

Cat. No.	Set Contains	Overall Length	Weight
VDV427-805-SEN	Impact Punchdown Tool 110 Type	7.1" (180 mm)	5.6 oz. (158.7 g)
Cat. No.	Color	Blade Configuration End 1	Blade Configuration End 2
VDV427-013	Yellow/Black	—	—
VDV427-015-SEN	Black	110 Terminate	110 Terminate and Cut

Dura-Blade™ 110/66 Cut Combination Punchdown Blade

- Dura-Blade™ is manufactured using metal injecting molding (MIM) technology for better quality, durability and performance
- Precise cutting-edge for clean, accurate wire insertion, termination and trimming
- Dual 110 and 66 cut and terminate ends for versatility
- Easy blade insertion with bayonet-style (twist & lock) form factor
- Compatible with most bayonet style (twist & lock) socket punchdown tools
- See our Cushion-Grip Impact Punchdown Tool Kit (VDV427-822) for everything required to install and maintain 110 and 66 panels, cross-connect systems and wall jacks



VDV427-104

Cat. No.	Color	Blade Configuration End 1	Blade Configuration End 2	Overall Length	Weight
VDV427-104	Chrome	110 Terminate and Cut	66 Terminate and Cut	2-13/64" (56.0 mm)	0.6 oz. (17 g)

See page 310 for additional information on warnings.



Punchdown Tools & Accessories

Punchdown Accessories

- Blades compatible with Klein® punchdown tools and other bayonet style (twist & lock) socket tools
- Precision ground cutting-edge for clean, precise wire termination (depending on blade type)
- Terminate, and adjust cable in variety of cross-connect panels, blocks and keystone jacks
- Induction-hardened high-carbon steel blades for durability and long life
- Reversible blades with termination/cutting ends and termination only ends (depending on blade type)
- WorkEnds™ Kit converts the Punchdown Multi-Tool chassis (Cat. No. VDV427-047) into a multi-bit driver
- Wire Pick (Cat. No. VDV327-103) is a professional pick/probe/spudger for precise maintenance of wires on blocks or jacks



VDV427-015



VDV427-016



VDV770-050*



VDV327-103

Cat. No.	Description	Color	Blade Configuration End 1	Blade Configuration End 2	Overall Length	Weight
VDV327-103	Wire Pick	Yellow	hook	spudger	7-1/4" (184.2 mm)	0.1 oz. (2.8 g)
VDV427-015-SEN	Punchdown Tool Blade 110 Type	Black	110 Terminate	110 Terminate and Cut	2-3/32" (53.2 mm)	0.5 oz. (14 g)
VDV427-016-SEN	Punchdown Tool Blade 66 Type	Black	66 Terminate	66 Terminate and Cut	2-19/64" (58.3 mm)	0.6 oz. (17 g)
VDV427-104	Dura-Blade™ 110/66 Cut Punchdown Blade	Chrome	110 Terminate and Cut	66 Terminate and Cut	2-13/64" (56.0 mm)	0.6 oz. (17 g)
VDV770-050	WorkEnds Kit	—	Proprietary Magnetic Hex	1/4" Female Hex	3013/64" (81.4 mm)	1.4 lbs. (0.64 kg)

*WorkEnds™ Kit is only compatible with VDV427-047, VDV427-806 and VDV427-807.

Crimp Tool and Die Sets

Ratcheting Crimper Frame

- Professional CATV, electrical, home theater, satellite and security system ratcheting crimper frame with optional dies is perfect for fast, reliable connector installations
- Full-cycle ratchet action assures a complete, precise crimp every cycle
- Preset tension for optimum performance
- Ratchet mechanism is designed to prevent the release of the connector prior to full compression
- Safety crimp release helps eliminate rejected terminations due to incorrect positioning
- Steel body with black-oxide finish for corrosion resistance and durability
- Thumb-screws secure die-sets for quick, easy changes
- Optional, quick interchangeable die sets thumb and Phillips screw set available (see table)



VDV200-010

Cat. No.	Overall Length	Weight
VDV200-010	8-3/4" (222.3 mm)	1.2 lbs. (0.54 kg)

Coaxial Hex-Crimp Die Sets

NOTE: Use caution when tightening thumb screws to prevent thread damage/stripping and hand tighten only; do not over-tighten the thumb screws. Over-tightening thumb-screws can damage the tool and/or die set.

Cat. No.	Die Set	Nest Dimensions	Cat. No.	Die Set	Nest Dimensions	Cat. No.	Die Set	Nest Dimensions
VDV999-033	Replacement Screw Set (Thumb and Phillips)	N/A	VDV211-037	RG58 RG59 RG6 RG62	0.256", 0.319", 0.068", 0.213" 6.50 mm, 8.10 mm, 1.73 mm, 5.41 mm	VDV211-041	RG58 RG59 RG6 RG62	0.255", 0.213", 0.098", 0.068", 0.321" 6.48 mm, 5.41 mm, 2.49 mm, 1.73 mm, 8.15 mm
VDV212-034	CATV F Connectors RG59 RG6	0.255", 0.320", 0.350" 6.48 mm, 8.13 mm, 8.89 mm	VDV211-038	RG58 RG59 RG6 RG62	0.256", 0.068", 0.213" 6.50 mm, 1.73 mm, 5.41 mm	VDV201-042	RG174 RG179 Belden 8218 and Fiber Optic	0.042", 0.068", 0.078", 0.128", 0.151", 0.178", 1.07, 7.73, 1.98, 3.25, 3.84, 4.52 mm
VDV205-035	Insulated Terminals, AWG 10-22	AWG 22 - 18/ 16 - 14/ 12 - 10 DIN 0.5 - 1.0/ 1.5 - 2.5/ 4 - 6 mm ²	VDV205-039	Pin Terminal Insulated or Non-Insulated Ferrules, AWG 12-22	AWG 22/20/ 18/16/14/12 DIN 0.5/0.75/ 1.0/ 1.5/2.5/ 4 mm ²	VDV211-043	RG8 RG11 RG174 RG179 RG213	0.100"/0.128"/ 0.429" 2.54/3.25/ 10.90 mm
VDV205-036	Non-Insulated Terminal or Open Barrel Terminal, AWG 10-20	AWG 20 - 18/ 16 - 14/ 12 - 10 DIN 0.5 - 1.5 - 2.5/ 4 - 6 mm ²	VDV201-040	RG58 RG59 RG62 RG174 Fiber Optic	0.043", 0.068", 0.100", 0.137", 0.213", 0.255", 1.09, 1.73, 2.54, 3.48, 5.41, 6.48 mm	VDV205-044	Non-Insulated Terminal, AWG 8-18	AWG 18 - 16/ 14/ 12 - 10/ 8 DIN 0.75 - 1.5/ 2.54/ 4 - 6/ 10 mm ²



Coaxial Cable Connectors

Klein Tools' Universal Compression Connector

Installs up to 5X faster!

Patented universal sleeve design provides excellent holding power and signal strength.

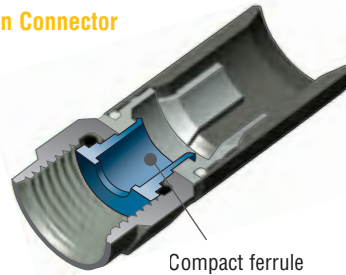

Standard Compression Connector

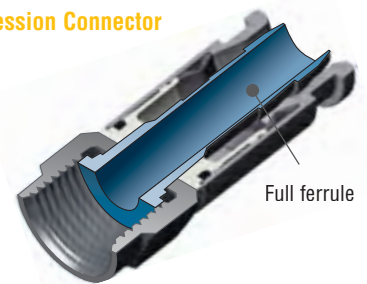

Universal				Standard	
Connector Type	F-Connector	BNC-Connector	F-Connector	F-Connector	F-Connector
Crimping Type	Compression	Compression	Compression	Compression	Compression
Cable Type:					
RG59	•	•	•	•	
RG6		•		•	•
RG6 QUAD SHIELD		•		•	
Universal Sleeve	•	•	•	•	
Outdoor Use					•
Cat. Nos:					
Pack Size: 10	VDV812-615	VDV812-606	VDV813-616	VDV813-607	VDV812-623
Pack Size: 35			VDV813-619	VDV813-613	
Pack Size: 50	VDV812-618	VDV812-612			VDV812-624
Klein Crimping Tools	VDV211-063, VDV211-048			VDV211-063, VDV211-048, VDV212-008-SEN	

Universal Compression Connectors

- Fit all manufacturers' diameter variations within a cable series
- Fit difficult to work with multi-shield and plenum cables
- For indoor use only

F • RG59



VDV812-615

F • RG6-RG6Q



VDV812-606

BNC • RG59



VDV813-616

BNC • RG6-RG6Q



VDV813-607

Cat. No.	Connector Type	Cable Type	Package Quantity
VDV812-615	F-Connector	RG59	10
VDV812-618	F-Connector	RG59	50
VDV812-606	F-Connector	RG6/6Q	10
VDV812-612	F-Connector	RG6/6Q	50
VDV813-616	BNC Connector	RG59	10
VDV813-619	BNC Connector	RG59	35
VDV813-607	BNC Connector	RG6/6Q	10
VDV813-613	BNC Connector	RG6/6Q	35

Standard Compression Connectors

- Full ferrule design
- Solid brass construction with nickel-plated finish
- Best choice for outdoors
- Great for satellite dishes



VDV812-623

Cat. No.	Connector Type	Cable Type	Package Quantity
VDV812-623	F-Connector	RG6	10
VDV812-624	F-Connector	RG6	50

Push-On Connectors

- Patented, tool-less, easy grip design
- Fits most major brands
- For indoor use only



VDV812-627

Cat. No.	Connector Type	Crimping Type	Cable Type	Package Quantity
VDV812-627	F-Connector	Push-on	RG6/6Q	10

F-Splice Adapter 3 GHz

- Patented gripping mechanism for optimal signal strength



VDV814-609

Cat. No.	Description	Package Quantity
VDV814-609	F-Splice Adapter 3 GHz	10



Twisted Pair Connectors

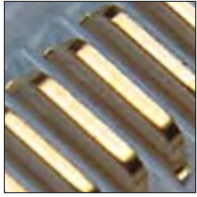

Klein's data and telephone plugs are professional-grade and deliver consistent, reliable performance.

They feature thick 50 micro-inch gold plating on the contact plates, three-pronged solid and stranded wire contacts, and durable connector housings. Expect a sure connection each and every time.



Connector Type	UY	UR	RJ11	RJ11	RJ45	
Position & Contacts	2P2C	3P3C	6P4C	6P6C	8P8C	
Connector Design	1-Piece	1-Piece	1-Piece	1-Piece	1-Piece	3-Piece
Gold Plating Thickness (micro-inch)			50µ"	50µ"	50µ"	50µ"
Cable Type:						
CAT 3	●	●	●	●		
CAT 5					●	
CAT 5e					●	
CAT 6						●
Solid Conductor Wire	●	●	●	●	●	●
Stranded Conductor Wire					●	●
Connector Color	Yellow	Red	Clear	Clear	Clear	Clear
Cat. No.						
Pack Size: 10					VDV826-628	
Pack Size: 25	VDV826-604	VDV826-605	VDV826-601	VDV826-600		VDV826-603
Pack Size: 50					VDV826-602	
Pack Size: 100					VDV826-611	
Crimping Type	IDC		Modular Plug Connector			
Klein Crimping Tools	D234-6, D234-6C, VDV026-049		VDV226-011-SEN, VDV226-107			

RJ45 Modular Data Plugs

- 8 position 8 contact
- For solid or stranded conductors

Cat. No.	Connector Type	Cable Type	Connector Color	Package Quantity
VDV826-628	RJ45	CAT 5/CAT 5e	Clear	10
VDV826-602	RJ45	CAT 5/CAT 5e	Clear	50
VDV826-611	RJ45	CAT 5/CAT 5e	Clear	100
VDV826-603	RJ45	CAT 6	Clear	25

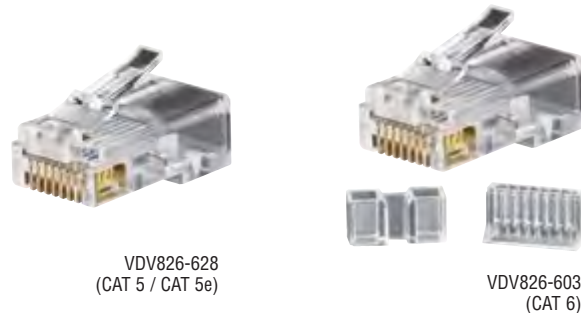

RJ11 Telephone Plugs

- 6 position 4 contact for 1 or 2 line telephones
- 6 position 6 contact for 1, 2 or 3 line telephones



Cat. No.	Connector Type	Position & Contacts	Connector Color	Package Quantity
VDV826-601	RJ11	6P4C	Clear	25
VDV826-600	RJ11	6P6C	Clear	25

Insulation Displacement Connectors

- Insulation displacement connector to add or terminate a telephone line
- Gel-filled for moisture resistance



Cat. No.	Connector Type	Position & Contacts	Connector Color	Package Quantity
VDV826-604	UY	2P2C	Yellow	25
VDV826-605	UR	3P3C	Red	25



Voice/Data/Video Tool Kits

VDV ProTech™ Kits

- For data and coaxial cable installations



















VDV026-831



VDV011-832



VDV001-833

Cat No.	Product	Description	VDV026-831	VDV011-832	VDV001-833
VDV000-133	 VDV ProTech™ Transport	Lightweight tool case with 12 organizational compartments for small parts and a large, open section to hold hand tools	•	•	•
VDV826-600	 Telephone Plug - RJ11 - 6P6C	Thick 50 micro-inch gold-plated and 3-pronged contacts with durable housing – for 1, 2 or 3 line telephones	• 25 pack		• 25 pack
VDV826-603	 Modular Data Plug – RJ45 - CAT6	Thick 50 micro-inch gold-plated and 3-pronged contacts with durable housing – 8 position, 8 contact 3-piece design for solid and stranded wire	• 25 pack		• 25 pack
VDV826-628	 Modular Data Plug – RJ45 - CAT5e	Thick 50 micro-inch gold-plated and 3-pronged contacts with durable housing – 8 position, 8 contact for solid or stranded wire	• 10 pack (x2)		• 10 pack (x2)
VDV812-606	 Universal F Compression Connector – RG6/6Q	Patented universal sleeve technology installs up to 5X faster and fits all diameter variations of RG6/6Q cable		• 10 pack (x2)	• 10 pack (x2)
VDV812-615	 Universal F Compression Connector – RG59	Patented universal sleeve technology installs up to 2X faster and fits all diameter variations of RG59 cable		• 10 pack	• 10 pack
VDV812-623	 F Compression Connector – RG6	All metal construction with dual O-ring to seal out moisture – satellite provider approved		• 10 pack (x2)	• 10 pack (x2)
VDV813-607	 Universal BNC Compression Connector – RG6/6Q	Patented universal sleeve technology installs up to 5X faster and fits all diameter variations of RG6/6Q cable		• 10 pack	• 10 pack
VDV813-616	 Universal BNC Compression Connector - RG59	Patented universal sleeve technology installs up to 2X faster and fits all diameter variations of RG59 cable		• 10 pack	• 10 pack
2100-8	 Free-Fall Snip – Stainless Steel	Stainless steel blades maintain blade durability and sharpness when cutting 19 and 23 AWG wire	•		•
VDV226-107	 Compact Ratcheting Modular Crimper	All inclusive tool cuts, strips and crimps data cables and modular data plugs	•		•
VDV211-048	 Compression Crimper – Compact, Multi-Connector	Crimps compression (F, BNC, RCA) connectors to coaxial cable		•	
VDV211-063	 Compression Crimper-Lateral, Multi-Connector	One tool crimps most compression (F, BNC, RCA) connectors to most coaxial cables including Mini-Coax, RG58, RG59, RG62, RG6Q, RG7 and RG11			•
VDV110-061	 Coax Cable Stripper – 2-Level, Radial	Provides one step, two-level stripping: 5/16" (7.9 mm) and 1/4" (6.4 mm)		•	•
63020	 Multi-Cable Cutter Klein-Kurve™	Cutter has a wide range of blades designed to cut various types of cable including solid and stranded copper wire, RG-59, RG6Q and RG-62 coaxial cable as well as other conductors		•	
VDV600-096	 Coaxial Cable Cutter – CCS	Cutter features a custom notch for CCS coaxial cable and standard shears for general purpose of cable including RG59, RG6, RG6Q, RG7, RG11 and Twisted pair copper wire.			•

See page 310 for additional information on warnings.



Voice/Data/Video Tool Kits

Coax Installer Starter Kit-F-Connectors

- Includes the tools needed to prepare and connect F-connectors
- Durable nylon tool pouch designed specifically for F-connector installation tools
- Additional pocket holds a screwdriver or common AA battery flashlights
- Pouch includes a closeable pocket that will hold up to 25 compression F-connectors (F-connectors not included)
- Tunnel-loop accommodates up to 2" belt



VDV012-811

Cat. No.	Kit Contains	Weight
VDV012-811		1.4 lbs. (0.64 kg)

Cat. No.	Description
63020	Multi-Cable Cutter Klein-Kurve®
VDV110-802-SEN	Radial Cartridge Stripper
VDV212-008-SEN	Compression Crimper Compact, F-Connector
kit exclusive	5-pocket nylon tool pouch plus closeable consumables pocket

LAN Installer Starter Kit - Modular

- Includes the tools needed to prepare, connect and test modular cables
- Durable nylon tool pouch designed specifically for modular plug installation tools
- Two additional pockets hold a screwdriver and common AA battery flashlights
- Pouch includes a closeable pocket that will hold up to 25 RJ45 plugs (RJ45 plugs not included)
- Tunnel-loop accommodates up to 2" belt



VDV026-812

Cat. No.	Kit Contains	Weight
VDV026-812		1.5 lbs. (0.68 kg)

Cat. No.	Description
2100-8	Free-Fall Snip Stainless Steel
VDV226-011-SEN	Ratcheting Modular Crimper/Stripper
VDV526-052	LAN Scout Jr. Tester
98554	Fine Point Permanent Markers
kit exclusive	5-pocket nylon tool pouch plus closeable consumables pocket

LAN Installer Starter Kit - Punchdown

- Includes the tools needed to prepare and connect 66 type and 110 type punchdown terminal blocks
- Durable nylon tool pouch designed specifically for punchdown installation tools
- Two additional pockets hold a screwdriver and common AA battery flashlights
- Tunnel-loop accommodates up to 2" belt



VDV027-813

Cat. No.	Kit Contains	Weight
VDV027-813		14.1 oz. (399 g)

Cat. No.	Description
2100-8	Free-Fall Snip Stainless Steel
VDV427047	PUNCHDOWN MULTI-TOOL CHASSIS
VDV427-015-SEN	Punchdown Tool Blade 110 Type
VDV427-104	Dura-Blade™ 110/66 Cut Punchdown Blade
98554	Fine Point Permanent Markers
kit exclusive	4-pocket nylon tool pouch

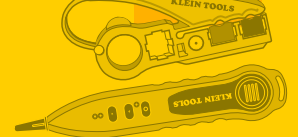

Voice/Data/Video Tool Kits

Coax Installation & Test Kit

- Includes tools needed to prepare, connect and test coax cables
- Coax Cable Stripper 2-Level, Radial: Designed for easy single operation cable preparations
- Compression Crimper Compact F-Connector: Crimps compression F-connectors to coaxial cable quickly and reliably
- Coax Explorer™ Tester: Compact tool tests and verifies coaxial cable connections (good/open/short)
- Universal F-Compression Connectors - RG6 / RG6-QS: Patented universal sleeve connectors install up to 5X faster



Cat. No.	Kit Contains	Weight
VDV002-818		1.1 lbs. (0.50 kg)
Cat. No.	Description	
VDV212-008-SEN	Compression Crimper Compact, F-Connector	
VDV110-061	Coax Cable Stripper 2-Level, Radial	
VDV512-057	Coax Explorer Tester	
VDV812-606	Universal F Compression Connector RG6/6Q Pk 10	

VDV002-818

Coax Push-On Connector Installation & Test Kit

- Includes tools needed to prepare, connect and test push-on coax cables
- Coax Cable Stripper 2-Level, Radial: Designed for easy single operation cable preparations
- Coax Explorer™ Tester: Compact tool tests and verifies coaxial cable connections (good/open/short)
- Push-On F-Connectors - RG6 / RG6-QS: Tool-less, patented cable grip design for easy installation and strong hold



Cat. No.	Kit Contains	Weight
VDV002-820		4.5 oz. (128 g)
Cat. No.	Description	
VDV110-061	Coax Cable Stripper 2-Level, Radial	
VDV512-057	Coax Explorer Tester	
VDV812-627	F Connector RG6/6Q Male Pk 10	

VDV002-820

Modular Installation Kit

- Includes tools needed to prepare and connect modular cables
- Ratcheting Modular Crimper/Stripper: All-in-one tool cuts, strips and crimps paired-conductor cables (RJ11 / RJ12, RJ22, RJ45)
- Modular Data Plug - RJ45 - CAT5e: Thick 50 micro-inch gold plating and 3-pronged contacts with durable housing - 8 position, 8 contact for data cables
- Telephone Plug - RJ11 - 6P6C: Thick 50 micro-inch gold plating and 3-pronged contacts with durable housing - for 1, 2 or 3 line telephones



Cat. No.	Kit Contains	Weight
VDV226-817		12.2 oz. (345 g)
Cat. No.	Description	
VDV226-011-SEN	Ratcheting Modular Crimper/Stripper	
VDV826-628	Modular Data Plug, RJ45, CAT5e 10 Pk	
kit exclusive	Telephone Plug - Rj11 - 6P6C (10 pack)	

VDV226-817

See page 310 for additional information on warnings.



WARNING: Do NOT use on energized circuits or cabling systems.

Voice/Data/Video Test & Measurement

VDV Commander™

- VDV Commander™ Series locates, tests and measures coaxial, data (RJ45) and telephone (RJ11) cables
- Measure cable length and distance to a fault with Time Domain Reflectometry (TDR) technology
- Locate and identify cables with location ID remotes, Test-n-Map™ remotes, Link Light and Tone Generator*
- Detect, identify and test Power over Ethernet (PoE)
- Perform active network (Ethernet) testing
- Save up to 256 cable or network tests and export to print reports
- Cat. No. VDV501-828: 1 Commander™ tester • Test-n-Map™ Remote #1 • 5 LanMap™ ID Remotes • 5 CoaxMap™ ID remotes • 1 test cable each for USB, RJ12 and RJ45 • 1 coax adapter • carrying case
- Cat. No. VDV501-829: 1 Commander™ tester • Test-n-Map™ Remote #1 • 1 PROBEplus Tone Tracing Probe • 20 LanMap™ ID Remotes • 20 CoaxMap™ ID remotes • 1 test cable each for USB, RJ12 and RJ45 • 1 coax adapter • carrying case



VDV501-828



VDV501-829



Cat. No.	Batteries	Battery Life	Height	Width	Depth	Weight
VDV501-828	6 AA Alkaline Included	20 Hours Active 10 Years Standby	6-51/64" (172.6 mm)	3-19/32" (91.3 mm)	1-27/32" (46.9 mm)	12.0 oz. (340 g)
VDV501-829	Commander: 6 AA Alkaline Included; Probe: 1 9V Alkaline Included	Commander: 20 Hours Active 10 Years Standby; Probe: 25 Hours Active 4 Years Standby	6-51/64" (172.6 mm)	3-19/32" (91.3 mm)	1-27/32" (46.9 mm)	12.0 oz. (340 g)

*Functionality requires analog probe VDV500-060 (included with Cat. No. VDV501-829)

VDV Commander™ Test-n-Map™ Remote Kit

- Maximize your VDV Commander™ with single-step Test-n-Map™ Remotes
- Test, map and identify a location in a single step
- Cuts testing and identification time in half
- Test and identify up to eight locations at once

Tester sold separately

Cat. No.	Test-n-Map™ Remotes	Coax F-Adapters	RJ45 jumper test cable	RJ11/RJ12 jumper cable	Verification Cables	Weight
VDV770-834	7	8	(8) 9" (228.6 mm)	(2) 9" (228.6 mm)	1	23.0 oz. (652 g)



VDV770-834

Features

	RJ-45 8-Wire Cables	●
	F-connector Coaxial Cables	●
	Telephone Cables	with adapter
	Wiremap	●
	Open Fault	●
	Short Fault	●
	Miswire Fault	●
	Split-Pair Fault	●
Pass	TIA-568A/B & Crossover/Uplink	●
	Active Ethernet Detects link speed and capabilities to 1 Gbps	●
	Single-End Cable Testing	●
	Test-n-Map™ Remote (Two End Testing) Test and Identify location in one step with remote	supports up to 8
	PoE Power Over Ethernet Testing	●
TDR	TDR Time Domain Reflectometry Length Measurement Method	●
	Measures Cable Length	1500 ft. / 457 m
$\pm(5\% + 1 \text{ Ft.})$	Accuracy/ Measurement Resolution	●
$\pm(5\% + 0.3 \text{ m})$		●
	Link Light	●
ID	Cable Identification	supports up to 20
	Shield Detection	●
	Voltage Warning	●
	Low Battery Indicator	●
	Store Test Results	256
	Print / Export Custom Reports	●
	Multiple-style Tone Generator* Down to Single Conductor/Pair/Cable	4
	Color LCD Display	2.7"
	Multiple Languages	ENG · ESP · FRA
Ft./m	Imperial or Metric Results	●
Apo	Auto Power Off	●
	Customizable Setup	●
	USB interface (for PC connection)	MICRO
	Upgradable Firmware (via internet download & pc connection)	●

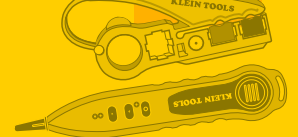

Voice/Data/Video Test & Measurement

VDV Scout™ Pro 2 Series

CE	Features	VDV Scout™ Pro 2	VDV Scout™ Pro 2 LT
		VDV501-823 VDV501-824	VDV501-825 VDV501-826
	Tests RJ45 8-wire cables	●	●
	Tests RJ11/12 6-wire cables	●	●
	Tests F-connector coaxial cables	●	●
	Continuity testing	●	●
Pass	TIA-568A/B & crossover/uplink	●	●
	Wiremap	●	●
	Detects open faults	●	●
	Detects short faults	●	●
	Detects miswires	●	●
	Detects split pairs	●	●
	Measures cable length	—	●
	Test-n-Map™ Remotes	Supports up to 8	Supports up to 8
ID	Twisted-pair (RJ45) cable ID location remotes	Supports up to 19	Supports up to 19
	Coaxial F-connector cable ID location remotes	Supports up to 19	Supports up to 19
	Multiple-style Tone Generator	4 Tones	4 Tones
	Low battery indicator	●	●
	Voltage warning	●	●
	Shield detection	●	●
Apo	Auto power off	●	●



VDV501-825
VDV501-826



VDV501-824



VDV501-823



Top View: RJ45, RJ11/12 and F-connector ports



VDV501-823 Self Storing Remote



VDV501-824, VDV501-825 and VDV501-826 Test-n-Map™ Self Storing Remote

Maximize your VDV Scout™ Pro with Test-n-Map™ Remotes

- Test, map and identify a location in a single step
- Cuts testing and identification time in half
- Test and identify up to eight locations at once

Test-n-Map™ Remote Kit Compatibility Chart

Cat. No.	Description	Kit No.	Button Color	Compatibility
VDV501-098	VDV Scout™ Pro 2 Tester	VDV501-823, VDV501-824		YES
VDV501-108	VDV Scout™ Pro 2 LT Tester	VDV501-825, VDV501-826		YES
VDV501-053	VDV Scout™ Pro Tester	VDV501-809		NO



See page 310 for additional information on warnings.



WARNING: Do NOT use on energized circuits or cabling systems.

Voice/Data/Video Test & Measurement

VDV Scout™ Pro 2 Series

- Tests continuity on voice (RJ11/12), data (RJ45) and video (F-connector) connections
- Locates cable runs to wall outlets with location ID remotes
- Compatible with single-step Test-n-Map™ Remotes
- Supports multiple tones and control of pins carrying tone with integrated tone generator†
- Measures cable length in feet or meters (LT models only) †Requires analog tone probe — sold separately



VDV501-824



VDV501-823



VDV501-825



VDV501-826



VDV770-827

		VDV Scout™ Pro 2 Tester Kit	VDV Scout™ Pro 2 Tester & Test-n-Map™ Remote Kit	VDV Scout™ Pro 2 LT Tester & Remote Kit	VDV Scout™ Pro 2 LT Tester & Test-n-Map™ Remote Kit	VDV Scout™ Pro 2 Test-n-Map™ Remote Kit
Items Included	Cat. No.	VDV501-823	VDV501-824	VDV501-825	VDV501-826	VDV770-827
VDV Scout™ Pro 2 Tester	VDV501-098		VDV501-098	—	—	—
VDV Scout™ Pro 2 LT Tester	—	—	—	VDV501-108	VDV501-108	—
Test-n-Map™ Remotes	—	—	8	1	8	8
LanMap™ Cable Identification Location Remotes	5	—	—	19	—	—
CoaxMap™ Cable Identification Location Remotes	5	—	—	19	—	—
Coax barrel F adapter (female to female)	1	—	1	1	1	—
Coax push-on F adapter (threaded male to push-on female)	—	—	8	—	8	8
RJ45 jumper test cable (9")	—	—	8	—	8	8
9V battery	●	●	●	●	●	●
Carrying case	—	—	●	●	●	●
Dimensions						
Height		2.75" (70 mm)	9" (229 mm)	9" (229 mm)	9" (229 mm)	9" (229 mm)
Width		6.3" (160 mm)	13" (330 mm)	11.5" (292 mm)	13" (330 mm)	13" (330 mm)
Depth		1.38" (35 mm)	4.375" (111 mm)	2" (51 mm)	4.375" (111 mm)	4.375" (111 mm)
Weight		13 oz. (369 g)	63 oz. (1786 g)	34 oz. (964 g)	63 oz. (1786 g)	56 oz. (1588 g)

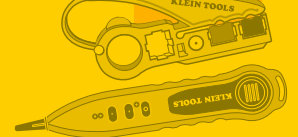

Voice/Data/Video Test & Measurement

LanMap™ Kit for VDV Scout™ Pro Series Tester

- Identify and map twisted-pair (RJ45) infrastructure, up to 19 locations
- For use with VDV Scout™ Pro Series and VDV Commander™ testers
- Heavy-duty design for long life and repeated connections
- Remotes numbered 1 through 19 for fast and accurate identification



Cat. No.	Height	Width	Depth	Weight
VDV526-055	3" (76.2 mm)	3-19/64" (83.7 mm)	1-13/32" (35.6 mm)	1.9 oz. (54 g)



VDV526-055

CoaxMap™ Kit for VDV Scout™ Pro Series Tester

- Identify and map coaxial (F-connector) cable infrastructure, up to 19 locations
- For use with VDV Scout™ Pro Series and VDV Commander™ testers
- Heavy-duty design for long life and repeated connections
- Remotes numbered 1 through 19 for fast and accurate identification



Cat. No.	Height	Width	Depth	Weight
VDV512-056	3" (76.2 mm)	3-19/64" (83.7 mm)	1" (25.4 mm)	5.2 oz. (147 g)



VDV512-056

VDV Scout™ Pro Series Carrying Case

- Custom designed compartments hold tester and accessories securely
- Dual zipper-pulls for quick access and EVA foam to cushion and protect
- Flexible case can accommodate various products and configurations
- Designed for use with VDV Scout™ Pro Series, LanMap™ and CoaxMap™ Kits



VDV770-080

Products not included

Cat. No.	Height	Width	Depth	Weight
VDV770-080	11-1/2" (292.1 mm)	8-3/4" (222.3 mm)	2-1/4" (57.2 mm)	15.0 oz. (425 g)



Voice/Data/Video Test & Measurement

LAN Scout™ Jr. Tester

- Tests continuity on twisted pair data wiring (RJ45) connections
- Integrated tone generator supports multiple tones and control of individual wires carrying tone
- Heavy-duty ports are designed for long life and repeated connections
- Large display for easy identification
- Compact, contoured dual-material chassis fits comfortably in your hand

Features	VDV526-052
RJ45 8-wire Cables	●
Continuity Testing	●
Pass TIA-568A/B & Crossover/Uplink	●
LED LCD Display	●
Wiremap	●
Open Fault	●
Short Fault	●
Miswire Fault	●
Split Pair Fault	●
Multiple Style Tone Generator	4
Self-Storing Remote	●
Low Battery	●
Apo Auto Power Off	●
Voltage Warning	●
Shield Detection	●



RJ45 Port



Self Storing Remote



VDV526-052



Cat. No.	Batteries	Height	Width	Depth	Weight
VDV526-052	6V to 4 x Lr44 Alkaline	4-39/64" (117.1 mm)	2-19/64" (58.3 mm)	1-7/64" (28.2 mm)	4.0 oz. (113 g)

Coax Explorer™ Testers

- Tests and verifies coaxial cable continuity
- Compact size fits easily into pocket or pouch
- Bright LED indicates cable status (good/open/short)
- Simple push-button operation
- Cat. No. VDV512-058 includes color coded remotes and a convenient remote holder to test up to 4 locations at once



VDV512-058



Cat. No.	Location ID	Batteries	Height	Width	Depth	Weight
VDV512-058	4	Lithium Non-Replaceable	5-39/64" (142.5 mm)	1-3/32" (27.8 mm)	1-1/4" (44.5 mm)	3.3 oz. (95 g)
VDV512-057	1	Lithium Non-Replaceable	2-45/645" (68.7 mm)	1-3/32" (27.8 mm)	45/64" (17.9 mm)	1.3 oz. (37 g)



VDV512-057



Voice/Data/Video Test & Measurement

PROBEplus-Tone Tracing Probe

- Trace wire paths and identify cables in common wiring systems
- Amplifier overload LED improves accuracy, warning against misreads
- Dual mode power button with Power-On LED indicator - tap or hold
- Recessed buttons prevent accidental operation
- Works with other manufacturers' analog tone generators
- Replacement tips available (Cat. No. VDV999-065)



VDV500-060



Features	VDV500-060
O.L. Amplifier Overload Indication	●
Adjustable Digital Volume Control	●
Tap-Mode Operation	●
Hold-Mode Operation	●
Power-On LED Indicator	●
Visual Notification	●
Apo Auto Power-Off	●
Low Battery Indicator	●
Replaceable Tip	●
Lanyard Attachment Loop	●

Cat. No.	Battery	Battery Life	Height	Width	Depth	Weight
VDV500-060	9V Not Included	25 Hours Active 4 Years Standby	9-29/32" (251.6 mm)	2" (50.8 mm)	1-9/64" (29.0 mm)	6.0 oz. (170 g)

TONEcube-Tone Generator

- Trace wire paths and identify cables in common wiring systems
- Five discrete tracing tones selected by tone switch
- Constant output level over useful battery life
- Momentary slide switches prevent accidental operation
- Heavy-duty leads with rugged dual-mode modular plug for direct connection to RJ11/RJ12 and RJ45 jacks via RJ12 plug
- Works with other manufacturers' analog tone probes



VDV500-051



Features	VDV500-051
Tones	5
Heavy-Duty Leads	●
Rugged Universal RJ11/RJ12/RJ45 Modular Plug	●
Continuity Testing	●
O.L. Voltage Overload Protection	●
+/- Line Status & Polarity	●
Power-On Flashing LED Indicator	●
Apo Auto Power-Off	●
Low Battery Indicator	●
Lanyard Attachment Loop	●

Cat. No.	Battery	Battery Life	Height	Width	Depth	Weight
VDV500-051	9V Not Included	120 Hours Active 4 Years Standby	2-45/645" (68.7 mm)	2-1/2" (63.5 mm)	1-27/64" (36.1 mm)	5.0 oz. (142 g)

TONEcube & PROBEplus Kit

- Trace wire paths and identify cables in common wiring systems
- Batteries not included



Cat. No.	Kit Contains	Weight
VDV500-808		16.0 oz. (454 g)
Cat. No.	Description	
VDV500-051	TONEcube Tone Generator	
VDV500-060	PROBEplus Tone Tracing Probe	
kit exclusive	nylon pouch	



VDV500-808

See page 310 for additional information on warnings.



WARNING: Do NOT use on energized circuits or cabling systems.

Voice/Data/Video Test & Measurement

TraceAll™ Tone & Probe

- Trace wire paths and identify cables in common wiring systems
- Heavy-duty RJ11 jack on tone generator for long life and repeated connections
- Includes RJ11 adapter to convert tone generator to an alligator-clip configuration
- Dual material chassis fits comfortably in your hand
- Replacement tips available (Cat. No. VDV999-059)



VDV526-054

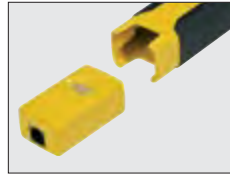

Self Storing Remote

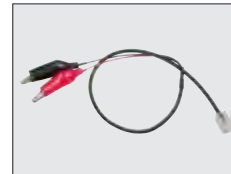

Adapter

Features	VDV526-054
Tone Generator	2
Adjustable Volume	●
Self-Storing Remote	●
Apo Auto Power-Off	●
Replaceable Tip	●



Cat. No.	Batteries	Battery Life	Height	Width	Depth	Weight
VDV526-054	6V 4 x LR44 Alkaline Included	Tracer: 10 Hours, Generator: 50 Hours	8-57/64" (225.8 mm)	1-45/64 (43.3 mm)	1-13/64" (30.6 mm)	5.0 oz. (142 g)

VDV Ranger™ TDR Kit

- Test and measure cable with the latest technology
- Time Domain Reflectometry Spread Spectrum (TDR-SS) Technology provides superior accuracy up to +/- (1% + 3 ft.) by eliminating interference when measuring cable
- TDR-SS technology broadens TDR environments by operating in Safety Extra Low Voltage (SELV) rated environments as defined by IEC. (SELV is 60 volts DC or Peak AC - 45 volts RMS)
- Measure paired-conductor cable length up to 3,000 ft. (914 m) including voice, data, video, doorbell, siamese, lamp-wire and NM cables
- Determine if cable run is broken or damaged
- Ensure compliance and identify cable runs outside specification
- The Tone Generator traces and identifies cables. Four tone cadences available†
- Measure cable remaining in box or on a reel
- Simplify cable estimating and bill jobs more accurately
- Adapter cord set includes BNC to F-connector adapter, F-connector adapter, insulated push-on F-connector to alligator clips, insulated BNC connector to alligator clips and insulated push-on F-connector to RJ45 modular plug



VDV501-815

Features	VDV501-815
Interface	Multi-Adapter Set
Measures Cable Length	●
Length Measurement Method	TDR-SS Spread Spectrum Time Domain Reflectometry
Accuracy & Resolution Measurement	±(1% + 3 ft.) ± (1% + 1 m) ●
Maximum Cable Length	3,000 ft. / 914 m
Common Cable Length Ranges <small>Must be paired conductors</small>	
RJ45 8-Cables	0 - 1,500 Ft. (457 m)
Coaxial Cable	0 - 2,000 Ft. (609 m)
Electrical Cable	0 - 1,000 Ft. (305 m)
Imperial & Metric Results	Ft./m ●
On-Board Calibration Memory	2 Storage Locations
Open Fault	●
Short Fault	●
Multiple Style Tone Generator†	4
Display	2.25" (57 mm) Backlit LCD
Voltage Warning	●
Low Battery	●
Auto Power Off	Apo ●



Includes custom designed polyester carrying case.

†Requires analog tone probe: VDV526-054 or VDV500-060 – both sold separately.)

Cat. No.	Batteries	Battery Life	Height	Width	Depth	Weight
VDV501-815	Four AA Alkaline Batteries Included	15 Hours Active, 4 Years Standby	6-51/64" (172.6 mm)	3-5/32" (80.2 mm)	1-19/64" (32.9 mm)	12.0 oz. (340 g)

X-ON Electronics

Largest Supplier of Electrical and Electronic Components

Click to view similar products for [klein tools](#) manufacturer:

Other Similar products are found below :

[D2000-28](#) [1550-2](#) [C63410](#) [A416-10](#) [5118S](#) [C17203](#) [C17302](#) [C18010](#) [C61306](#) [C63306](#) [VO4](#) [63060](#) [1010](#) [D310-6C](#) [71980](#) [5141](#) [CL210](#)
[51425](#) [VDV501-826](#) [VDV501-828](#) [502-10EINS](#) [32228INS](#) [32244INS](#) [32245INS](#) [32268INS](#) [1656-30](#) [44001](#) [54451](#) [701-S](#) [D301-6C](#) [56208](#)
[69454](#) [69406](#) [55431](#) [55448](#) [56400](#) [56511](#) [D201-7CSTA](#) [63041](#) [VDV110-295](#) [LLK12](#) [VDV205-039](#) [55452RTB](#) [VDV770-851](#) [VDV512-](#)
[007](#) [ET140](#) [IR07](#) [605-6B](#) [44213](#) [J1005](#)