



PLAZMO INDUSTRIES

PHONE : 402-330-2222 FAX : 886-499-2235

69900200 SPECIFICATION

**Document No:** SA- 20160421-01

**Version No:** A

**Customer's part No:** 4 Wire, 6.2" Touch Screen

**Product No:** 69900200

**Issue Date:** 2012-04-20

## 1 Product type

1.1 Resistance Type Analogy Type

1.2 Film/Glass Type

## 2 Criteria of Materials

### 2.1 Uper Electrode

- 2.1.1 Base material: ITO FILM
- 2.1.2 Type: Anti-glare and anti-glare hard ring
- 2.1.3 Thickness:  $188 \pm 10 \mu\text{m}$
- 2.1.4 Resistance:  $400 \pm 100 \Omega/\text{sq}$

### 2.2 Lower Electrode

- 2.2.1 Base material: ITO GLASS
- 2.2.2 Thickness:  $1.10 \pm 0.10 \text{mm}$
- 2.2.3 Resistance:  $400 \pm 100 \Omega/\text{sq}$

### 2.3 Connector Tail

- 2.3.1 type: FPC connect (Double side)

## 3 Characteristics

### 3.1 Mechanical characteristics

- 3.1.1 Outside dimension:  $165.30 \pm 0.30 \text{mm} \times 70.00 \pm 0.30 \text{mm}$
- 3.1.2 View area:  $153.80 \text{mm} \times 58.76 \text{mm}$

- 3.1.3 Thickness:  $2.10 \pm 0.10 \text{mm}$
- 3.1.4 Input method: Pen or Finger
- 3.1.5 Operating force:  $30 \sim 120 \text{g}$  A.A area shrunk within 3mm  
Shape of pen end:  $\varnothing 0.3 \text{ mm} \sim \varnothing 0.5 \text{mm}$
- 3.1.6 Hardness of surface: Hard surface :  $\geq 3 \text{H}$  [ JIS K 5400 ]
- 3.1.7 Heat seal intensity: X $>2.0 \text{kgf}$  Y $>500 \text{gf}$  Z $>150 \text{gf}$  Bend radius ( $180^\circ$ )  $\square 1 \text{mm}$
- 3.1.8 FPC bending resistance test ; bending radii: 1mm, bending times: 3 times or more than 3 times ( Satisfaction:Electrical characteristics 3.2.2 and Loop resistance)

### 3.2 Electrical characteristics

- 3.2.1 Operating Voltage: DC5V
- 3.2.2 Loop resistance: X:  $50 \sim 450 \Omega$  Y:  $800 \sim 1250 \Omega$
- 3.2.3 linearity :  $\leq \pm 1.5 \%$
- 3.2.4 Insulation resistance:  $> 20 \text{M}\Omega$  At DC 25V.
- 3.2.5 Insulation ability:  $\geq 60 \text{sec.}$  At DC 25V.
- 3.2.6 Chattering times:  $< 10 \text{ms}$
- 3.2.7  $C \leq 6 \text{nf}$

### 3.3 Optical characteristics

- 3.3.1 Total Transmittance:  $\geq 76\%$  [JISK 7105]

## 4 Processing Environment:

- 4.1 Operating Temperature:  $-20^\circ \text{C} \sim +60^\circ \text{C}$
- 4.2 Operating Humidity:  $\leq 90\% \text{RH}$
- 4.3 Storage Temperature:  $-30^\circ \text{C} \sim +70^\circ \text{C}$
- 4.4 Storage Humidity:  $< 90\% \text{RH}$

## 5 Environmental test

- 5.1 High temperature:  $+70^\circ \text{C}$ , 240 hr.
- 5.2 Low temperature:  $-20^\circ \text{C}$ , 240hr.
- 5.3 High temp./high humidity test:  $70^\circ \text{C} \& 90\%$ , 240hr.
- 5.4 High Low temperature test:  $-20^\circ \text{C}$  30min/ $+80^\circ \text{C}$  30min, This is the test of 100 Cycle with 240hr.(30min in either temperature increase or decrease). Taken out from environmental measurement machine, and placed 24hr in room temperature before test. The followings conditions are necessary:

- ▲ Closed impedance

$50 \Omega < \text{X Axis} < 450 \Omega$                        $800 \Omega < \text{Y Axis} < 1250 \Omega$

- ▲ Linearity error

X Axis:  $\leq \pm 1.5\%$                       Y Axis:  $\leq \pm 1.5\%$

- ▲ Insulation impedance

$> 20 \text{M}\Omega$  @ DC 25V

### 5.5 Notes life $\geq 2 \times 10^4$ words min

Shape of pen end: R0.8mm                      Materials of pen: Poly acetal resin written

Load:  $150 \text{g}$                       Speed: 60mm/s

sliding range: A.A area shrunk within 3mm

Underlined 100,000 times in a fixed position of TOUCH PANEL. If sliding back and force, it counts twice , The following conditions are necessary:

- ▲ Closed impedance  
 $50\Omega < X \text{ Axis} < 450\Omega$                        $800\Omega < Y \text{ Axis} < 1250\Omega$
- ▲ Linearity error  
X Axis:  $\leq \pm 1.5\%$                                       Y Axis:  $\leq \pm 1.5\%$
- ▲ Insulation impedance  
 $> 20M\Omega @ DC 25V$

**5.6 Input life**  $\geq 1 \times 10^6$  times min

- Shape of pen end: R8.0mm                      Materials of pen: SIR60°
- Load: **150g**    Frequency: 2times/s
- Click range: A.A area    shrunk within 3mm

Pointed-making 1million times in a fixed position of TOUCH PANEL. The following conditions are necessary:

- ▲ Closed impedance  
 $50\Omega < X \text{ Axis} < 450\Omega$                        $800\Omega < Y \text{ Axis} < 1250\Omega$
- ▲ Linearity error  
X Axis:  $\leq \pm 1.5\%$                                       Y Axis:  $\leq \pm 1.5\%$
- ▲ Insulation impedance  
 $> 20M\Omega @ DC 25V$

## 6 Inspection Criteria

### 6.1 Inspection Scope

The following criteria only apply to the viewed parts of touch screen, and the non-viewed parts are free of inspection of shatter crack, scratch and impurities on appearance if without functional errors. The surface touch screen is touch surface—the face of product; while the glass surface is non-touched surface—the back of product.

### 6.2 Sampling Plan/ Allowed Standard in Inspection

MIL-STD-105E II:

AQL Critical    0.01        -----    Electrical performance

AQL Major      0.65        -----    Dilapidation, unqualified

AQL Minor      1.0        -----    Scratch, impurities, smudge and tilted rims are not

obvious.

### 6.3 Requirement of Inspection Conditions

Check distance: 30-45cm                                      Light source: 500-800Lux





Angle: the product 45°beveled to table surface°    Sight: 1.0

Time: 10s-20s.

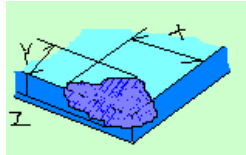
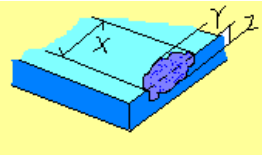
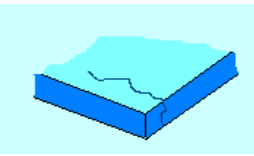
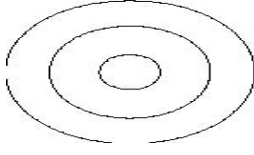
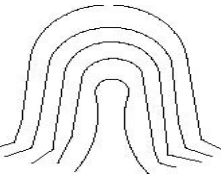
### 6.4 Inspection Specifications

- (1) Clear visual outline, and specified the smudge, judge the standard of impurities.
- (2) Unclear visual outline, specified the smudge. The ones can not be defined through light are qualified.
- (3) The following standard only relate to display area. Any inferior items lies outside of display area will be acceptable if not affect the function

Contents		Blemish picture	Type	Standard	Judge	Remarks
The Glass is damaged	It's damaged to turn Cape		Ma	$X \leq 4.0\text{mm}$	OK	on basis of without affecting functions
				$Y \leq 3.0\text{mm}$	OK	
				$Z \leq T$	OK	
	In addition to turning Cape any breakage of scope		Mi	$Y \leq 2.0\text{mm}$	OK	on basis of without affecting functions
$Z \leq 1/2T$				OK		
			Ma	$X \leq 4.0\text{mm}$	OK	
Flaw			Cr	Product any part exists broken	NG	
Spot ((includes white and black spots))			Mi	$D \leq 0.15\text{mm}$ (not allowed over 3 pieces gathered in the circle of 5mm diameter)	OK	
			Ma	$0.15 < D \leq 0.25\text{mm}$ , n=2 gap > 25mm ,OK	OK	
			Cr	$D > 0.25\text{mm}$	NG	
Scratch			Mi	$W \leq 0.03\text{mm}$	OK	
			Ma	$0.03 < W \leq 0.07$ , $L \leq 8\text{mm}$ n=2 gap > 20mm, OK	OK	
			Cr	$W > 0.07\text{mm}$	NG	
Linear			Mi	$W \leq 0.03\text{mm}$	OK	
			Ma	$0.03 < W \leq 0.07$ , $L \leq 6\text{mm}$ gap > 20mm, OK	OK	
			Cr	$W > 0.07\text{mm}$	NG	
Newton's ring	The rule Newton's wreath		Mi	It can be accepted when the area of Newton's ring generated by T/P is less 1/5 of T/P area, and the words and linear are not distorted after lighting.	OK	
Newton's ring	Irregular Newton's wreath		Ma	It is judged as unqualified when the area of Newton's ring generated by T/P exceeds 1/4 of T/P area.	NG	
ICON Carry on the back			Ma	Can see area 、ICON Dirty	NG	

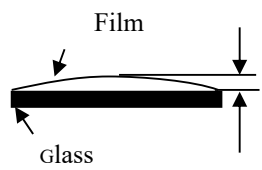
gum district (The silk prints form of written)			stain、Linear、Bubble It is standard to press the IP parts of stain, line thing and bubble examination.		
		Cr	The outside frame outruns a product edge, inside the frame get into to see area.	NG	
Inside dirty (Product inner part)		Ma	Present a shape	NG	At the light descend the eyes see to see inside the area to outrun to order standard scope inside the dirty diameter size of piece-like in shape obviously dirty vestige
			Long-like in shape		
			Concentrated form		
			Inclined line-like in shape		
			Water is line-like in shape (Contain palm lines)		
Protection film and surface dirt		Mi	The protection film is stuck to product both sides, edge and product to align.The protection film outruns a product edge $\leq 2$ mms.	OK	
		Ma	After product starts to tore a protection film, eyes' seeing to check TP surface is dirty to print.	NG	
Film drum		Ma	The film summons up can not over 0.30mms	OK	
		Cr	The film summons up over 0.30 mms.	NG	

Remark:

W: Width ;

L: Length ;

Dis: Distance ;

D: diameter.

## 7 packing transportation

**7.1 Packing** The attached smudge are not allowed, and packed by polystyrene materials.

**7.2 Transportation** Avoid direct sunshine and high temperature or humidity during transportation.

## **8 Attention**

- 8.1** The surface touch screen is touch surface—the face of product; while the glass surface is non-touched surface—the back of product.
- 8.2** Partial touch surface are made by glass whose margin or rim is sharp, and put on gloves when assembling.
- 8.3** Partial touch screen are made by fragile glass, never impact the touch screen forcefully when assembling.
- 8.4** Avoid to take up touch screen from down-lead part directly, as well as any drag action on leading position.
- 8.5** Any bent or fold actions are banned in the position of lead reinforced plate.
- 8.6** Any folio in the position of lead reinforced plate are banned, and the bend or fold radius should be  $> 1.5\text{mm}$  during assembly process.
- 8.7** Insert the lead directly rather than folio in the reinforcement plate base when assembling the lead.
- 8.8** Conduct single-piece operation when fetch products, bring and put slightly to avoid scratching the product surface caused by colliding.
- 8.9** Cleaning the product surface by soft cloth(deerskin)dipped with Petroleum ether.
- 8.10** Banned to piled up the touch screen.
- 8.11** Pay attention to the followings when assembly design and frame design.
  - 8.11.1** Fix the frame support of touch screen outside the viewed parts of touch screen.
  - 8.11.2** The side of frame should be out of operation parts of touch screen.
  - 8.11.3** The plastic materials are recommended to be applied in touch screen, and the front part should be padded with soft materials.
  - 8.11.4** The glue with corrosion is not allowed to stick the surface of touch screen.
- 8.12** Comply with ROHS standard.

## **9 Interrelated drawing** Refer to Attachment(1 pages total)

## **10 Using Instructions**

### **10.1 Operation Instructions**

#### **11.1.1 Caution**

This product is suitable only for equipment of common usage (for example, office-auto equipment, machines or related to business communication, and home electronics). When damaged or misused which may cause body injury, please stop using. Also, do not use on special equipment of extremely high-reliability standard, such as space sciences, nuclear power controller or health care equipment..

### **10.2 Notice of Design installation**

- 10.2.1 Avoid the design that Front-case over lap and press on the active area of the touch panel. Give enough gap (0.2mm ~ 0.30mm at compressed) between the front Case and touch panel to protect wrong operating:

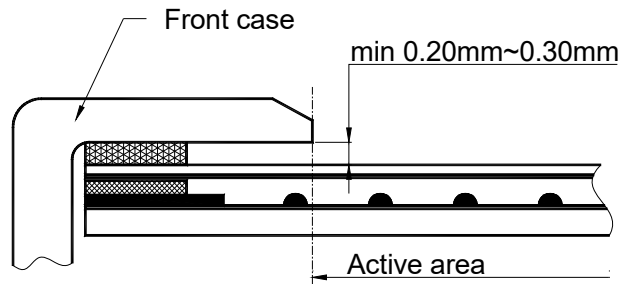

- 10.2.2 When designing the Front-case, you are kindly reminded to watch out the Operation non-guaranteed area of touch panel all around. Due to the gap made by the circuit at the edge of non-guaranteed area, the ITO FILM will be damaged easily when touching this area with pressure. We recommend to design the case according to the boundary of the ACTIVE AREA, and it is very important to reserve a distance (as the "B" area in the following drawing) no less than 0.30mm between the edge of case and the boundary of VA area. At same time pls adopt the buffer material (Gasket) between the touch panel and Front-case in case of the damage and wrong operating, the distance between the edge of buffer material and the boundary of VA area (as the "C" area in the following drawing) should be no less 0.50mm.

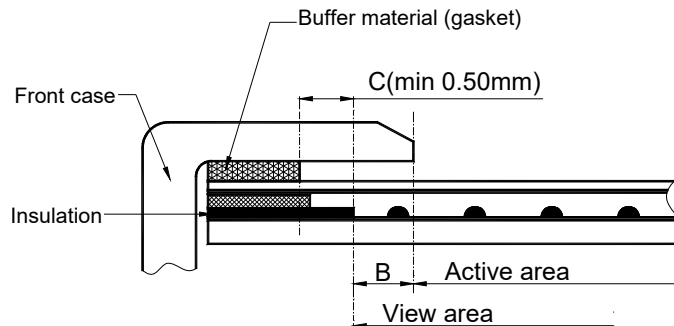

- 10.2.3 The corners of the product are not tipped when installing to case, so, we suggest that the corner may be designed R part of case so as not to apply load to corner of touch panel.

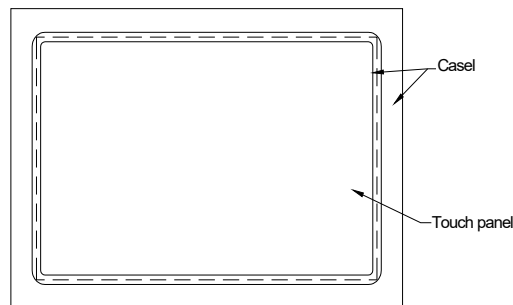

- 10.2.4 When design case for installing touch panel, you would consider give a

distance between touch panel edge to case inside.

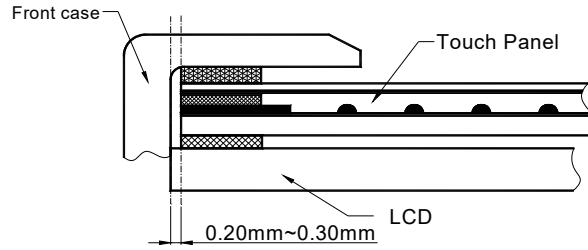

10.2.5 The view area of the touch panel should be at least as large as the view area of LCD, and the active area of the touch panel should be at least as large as the active area of LCD.

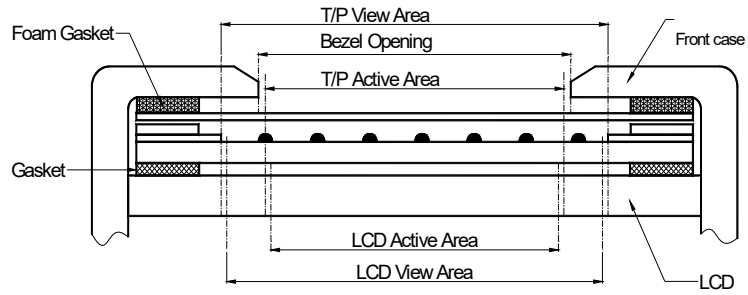



## **X-ON Electronics**

Largest Supplier of Electrical and Electronic Components

*Click to view similar products for [plazmo industries manufacturer](#):*

Other Similar products are found below :

[29900700-10PK](#) [29901300-10PK](#) [29903100](#) [10600110-25PK](#) [29900900-10PK](#) [29903300](#) [29903410](#) [29902720](#) [29903510](#) [29902900](#)  
[29903200](#) [19901820](#) [59900919](#) [69900200](#)